



Laboratory Procedure Manual

Analyte: **Benzophenone-3, bisphenol A, 2,4-dichlorophenol, 2,5-dichlorophenol, ortho-phenylphenol, methyl-, ethyl-, propyl-, and butyl parabens, 4-tert-octylphenol, 2,4,5-trichlorophenol, 2,4,6-trichlorophenol, triclosan**

Matrix: **Urine**

Method: **On line SPE-HPLC-Isotope dilution-MS/MS**

Method No.: **6301.01**

Revised: **April 13, 2009**

as performed by:

Organic Analytical Toxicology Branch
Division of Laboratory Sciences
National Center for Environmental Health

contact:

Dr. Antonia Calafat
Phone: 770.488.7891
Fax: 770.488.4371
Email: ACalafat@cdc.gov

Dr. Eric J. Sampson, Director
Division of Laboratory Sciences

Important Information for Users

The Centers for Disease Control and Prevention (CDC) periodically refines these laboratory methods. It is the responsibility of the user to contact the person listed on the title page of each write-up before using the analytical method to find out whether any changes have been made and what revisions, if any, have been incorporated.

Table of Contents**Public Release Data Set Information**

This document details the Lab Protocol for testing the items listed in the following table:

Lab Number	Analyte	SAS Label
EPH_D	URXBPH	Urinary Bisphenol A (ng/mL)
	URXBP3	Urinary Benzophenone-3 (ng/mL)
	URX4TO	Urinary 4-tert-octylphenol (ng/mL)
	URXTRS	Urinary Triclosan (ng/mL)
	URXBUP	Butyl paraben (ng/ml)
	URXEPB	Ethyl paraben (ng/ml)
	URXMPB	Methyl paraben (ng/ml)
	URXPPB	Propyl paraben (ng/ml)

1. Clinical Relevance and Summary of Test Principle

a. Clinical Relevance

The method is used for the biomonitoring of environmental phenols to evaluate their exposure prevalence in humans. The routes of human exposure to these phenolic compounds may include industrial pollution, pesticide use, food consumption, and use of consumer and personal care products. Specifically, bisphenol A (BPA) is used in the manufacture of polycarbonate plastics and epoxy resins, which are used in baby bottles, as protective coatings on food containers, and as composites and sealants in dentistry; BPA may also be used in the thermal paper and polyvinyl chloride industries.[1] Alkylphenols (APs), such as 4-tert-octylphenol, are used in the manufacture of nonionic surfactants used in detergents.[2,3] Chlorophenols have been used in the wood preservation industry, as intermediates in the production of pesticides, and as disinfectants or fungicides for industrial and indoor home use. The manufacture of other chlorinated aromatic compounds can produce chlorophenols as byproducts. Phenols are also used as sunscreen agents for skin protection, and as UV filters in cosmetic products and plastics to improve stability (e.g., benzophenone-3 [BP-3]), or used as bactericides (e.g., triclosan) in soap and other personal care products. Parabens are a group of alkyl (e.g., methyl, ethyl, propyl, butyl) esters of *p*-hydroxybenzoic acid widely used as antimicrobial preservatives, especially against molds and yeast, in cosmetic products and pharmaceuticals, and in food and beverage processing. [4-7]

Many environmental phenols and their environmental precursors have been on the market for decades. Chlorinated phenols were monitored and regulated mainly due to carcinogenic properties observed in a wide range of wildlife organisms.[8] During the 1990s, scientific studies raised new potential public health concerns about the estrogen-mimicking nature of several environmental phenols.[9-11] Low doses of BPA administered perinatally modified sexual behavior in rats.[12] At present, the interpretation of the evidence related to the low-dose effects of BPA is a subject of scientific debate [1,13-17]

The number of environmental phenols which are under scrutiny because of their potential endocrine activity is increasing. Sunscreen agents such as benzophenone-3 stimulate cell proliferation in breast cancer cells.[18] Some phenols, such as triclosan, in addition to being hormonally active,[19] may enhance estrogenic effects by inhibiting hepatic phase II enzymes, which are responsible for the glucuronidation and sulfonation,[20] the main elimination mechanism of phenolic toxicants and metabolites from the body. Parabens have been found in human breast tumors.[21] In particular, butyl paraben was nominated by the National Institute of Environmental Health Sciences for toxicological characterization, including reproductive toxicity studies.[22] The estrogenic activity of parabens in animals and the presence of these compounds in human breast tissue have raised the concerns about their safety. Although most environmental phenols display only weak estrogenic properties, continuous exposure to low levels of these compounds could induce changes in growth,

development, reproduction or behavior.[12,23,24] Furthermore, parallel exposure to environmental phenols and to other hormonally-active compounds, such as phthalates, PCBs, and phytoestrogens may induce combined adverse health effects.[12,23-26] Because of their wide spread use and potential risk to public health, biomonitoring of environmental phenols is warranted.

b. Test Principle

We have developed a sensitive method for measuring BPA, benzophenone-3 (BP-3), 4-tert-octylphenol (tOP), and five chlorophenols [2,4-dichlorophenol(24-DCP), 2,5-dichlorophenol (25-DCP), 2,4,5,-trichlorophenol (245-TCP), 2,4,6-trichlorophenol (246-TCP) and triclosan].[27] The method was updated to include several parabens (methyl-, ethyl-, propyl-, and butyl paraben).[28] These methods use on-line solid phase extraction (SPE) coupled to high-performance liquid chromatography–isotope dilution tandem mass spectrometry (MS/MS) with peak focusing.[27,28] Briefly, the conjugated species of the phenols in 100 μ L of urine are hydrolyzed by use of β -glucuronidase/sulfatase (*H. pomatia*); this deconjugation step is omitted when measuring the concentrations of the free species. After hydrolysis, samples are acidified with 0.1 M formic acid; the phenols are preconcentrated by online SPE, separated by reversed-phase HPLC, and detected by atmospheric pressure chemical ionization (APCI)–MS/MS.

2. Safety Precautions

a. Reagent Toxicity or Carcinogenicity

Some of the reagents used are toxic. Special care should be taken to avoid inhalation, eye or skin contact to the reagents used throughout the procedure. Avoid use of the organic solvents in the vicinity of an open flame, and use solvents only in well-ventilated areas. Care should be exercised in handling of all chemical standards.

β -Glucuronidase and formic acid are known sensitizers. Prolonged or repeated exposure to the sensitizer may cause allergic reactions in certain sensitive individuals. Chronic exposure to proteinase K could cause nausea and vomiting, and acute exposure may cause unconsciousness.

Note: Material Safety Data Sheets (MSDS) for the chemicals and solvents used in this procedure can be found at http://www.msdsxchange.com/english/xchange_search.cfm. The hard copy may be found in the binder in the laboratory. Laboratory personnel are advised to review the MSDS before using chemicals.

b. Radioactive Hazards

None.

c. Microbiological Hazards

The possibility of being exposed to various microbiological hazards exists. Appropriate measures should be taken to avoid any direct contact with the specimens (i.e., utilize gloves, chemical and/or biological hoods). A Hepatitis B vaccination series is recommended for health care and laboratory workers who are exposed to human fluids and tissues. Laboratory personnel handling human fluids and tissues are required to take the "Bloodborne Pathogens Training" course offered at CDC to insure proper compliance with CDC safe work place requirements.

d. Mechanical Hazards

There are only minimal mechanical hazards when performing this procedure using standard safety practices. Laboratorians should avoid any direct contact with the electronics of the mass spectrometer, unless all power to the instrument is off. Generally, only qualified technicians should perform the electronic maintenance and repair of the mass spectrometer. Contact with the heated surfaces of the mass spectrometer should be avoided; also, care must be taken to avoid puncture wounds from the corona discharge needle when removing the APCI interface.

e. Protective Equipment

Standard safety protective equipment should be utilized when performing this procedure. This includes lab coat, safety glasses, and nitrile or latex gloves.

f. Training

Training in the use of an HPLC system and a triple quadrupole mass spectrometer should be obtained by anyone using this procedure. Operators are required to read the laboratory standard operating procedures manual. Formal training is not necessary; however, an experienced user should train all of the operators.

g. Personal Hygiene

Care should be taken in handling any biological specimen. Routine use of gloves and proper hand washing should be practiced. No food or drink is allowed in laboratory areas.

h. Disposal of Wastes

Solvents and reagents are disposed of in an appropriate container clearly marked for waste products. Containers, glassware, etc., that come in direct contact with the specimen are either autoclaved or decontaminated with 10% bleach. Contaminated analytical glassware is treated with bleach, washed and reused; disposable labware is autoclaved prior to disposal. To insure proper compliance with CDC requirements, laboratory personnel are required to take annual hazardous waste disposal courses.

3. Computerization; Data-System Management

a. Software and Knowledge Requirements

All samples are queued for analysis in a database created using Microsoft Access. Mass spectrometry data are collected and stored using the Analyst software (Applied Biosystems, Ontario, Canada). During sample preparation and analysis, samples are identified by their Sample Name and Sample ID. The Sample Name is a number that is unique to each sample during the sample preparation and the mass spectrometry measurement. The unique Sample ID, included on the label of each sample vial, is used to identify each specimen. In case of repeated measurements, the sample can have more than one Sample Name, but only one Sample ID in the database. The Sample ID links the laboratory information with the demographic data recorded by the sample takers. All raw mass spectral data are archived for future reference. All raw data files are analyzed using the Analyst/Quantitation Wizard program, which allows manual peak selection and area integration. These raw data (peak area, peak height, retention time, analyte name, MRM name) are exported to the Access database used for storage and retrieval. This Access database is stored on the secure DLS-PC network as well as in several archive locations. Statistical analysis of the data, programming, and reporting are performed using the Statistical Analysis System (SAS) software (SAS Institute, Cary, NC). Knowledge and experience with these software packages (or their equivalent) are required to utilize and maintain the data management structure.

b. Sample Information

Sample Names and Sample IDs, sample volume and study number are entered into the Access database before sample preparation. If possible, for unknown samples, the sample IDs are read in by a barcode reader directly from the sample vials. Sample IDs for the quality control materials (QCs) are entered manually. The Sample Log Sheet containing Sample Names and Sample IDs is printed from the Access database and is used to record information during the sample preparation. After MS data collection and peak integration, the data are exported into a text file which is then imported into the Access database.

c. Data Maintenance

All sample and analytical data are checked after being entered into the database for transcription errors and overall validity. The database is routinely backed up onto a computer hard drive and onto a network drive. Data from completed studies are saved on a CD-ROM and on an external hard drive. Additionally, final reports are saved as paper copy as an official government record.

4. Procedures for Collecting, Storing, and Handling Specimens; Criteria for Specimen Rejection

a. Sample Collection

Urine specimens are collected from subjects in standard urine collection cups. Samples should be refrigerated as soon as possible. Preferably, the specimen should be transferred to specimen vials within 4 hours of collection. If at all possible, at least five milliliters of urine is collected, and can be stored frozen in borosilicate glass, polypropylene vials or specimen cups. Teflon coated stoppers can be used, but crimped caps with rubber stoppers should not be used because they may contain tOP. The specimens are then labeled, frozen, and stored on dry ice for shipping. Special care must be taken in packing to protect bottles from breakage during shipment. All samples should be stored frozen until analysis.

b. Sample Handling

Samples are thawed, aliquoted, and the residual specimen is stored frozen.

5. Procedures for Microscopic Examinations; Criteria for Rejecting Inadequately Prepared Slides

Not applicable for this procedure.

6. Preparation of Reagents, Calibration (Standards), Controls, and All Other Materials; Equipment and Instrumentation**a. Reagents and Sources**

Methanol (MeOH), formic acid, and water (Tedia; Fairfield, OH) were analytical or HPLC grade. Bisphenol A (BPA), 4-tert-octylphenol (tOP), ortho-phenylphenol (OPP), triclosan (5-chloro-2-(2,4-dichlorophenoxy)phenol), 2,4-dichlorophenol (2,4-DCP), 2,5-dichlorophenol (2,5-DCP), 2,4,5-trichlorophenol (2,4,5-TCP), 2,4,6-trichlorophenol (2,4,6-TCP), methyl-, ethyl-, propyl-, and butyl parabens, β -glucuronidase (*Helix pomatia*, H1), ammonium acetate, 4-methylumbelliferyl glucuronide and 4-methylumbelliferyl sulfate were purchased from Sigma Aldrich Laboratories, Inc. (St. Louis, MO). Benzophenone-3 (BP-3, 2-hydroxy-4-methoxybenzophenone, Eusolex 4360) was provided by EMD Chemicals Inc. (Hawthorne, NY). $^{13}\text{C}_{12}$ -BPA, $^{13}\text{C}_6$ -OPP, $^{13}\text{C}_6$ -2,4-DCP, $^{13}\text{C}_6$ -2,5-DCP, $^{13}\text{C}_6$ -2,4,5-TCP, $^{13}\text{C}_6$ -2,4,6-TCP, and $^{13}\text{C}_4$ -4-methylumbelliferone were obtained from Cambridge Isotope Laboratories Inc. (Andover, MA). $^{13}\text{C}_6$ -triclosan was purchased from Wellington laboratories Inc. (Ontario, Canada). D_3 , ^{13}C -BP3 was obtained from Los Alamos National Laboratory (Los Alamos, NM), D_4 -tOP was from Hayashi Pure Chemical Ind., Co. Ltd. (Japan), D_4 -methyl paraben from CDN Isotopes (Quebec, Canada), and D_4 -ethyl, D_4 -propyl, and D_4 -butyl parabens from CanSyn Chem Corp. (Toronto, Canada).

b. Working Solutions

(1) 1.0 M Ammonium acetate buffer, pH 5.0

Weigh 77.08 g of ammonium acetate into a 1000 mL beaker. Add 800 mL HPLC-grade H₂O and mix vigorously until all ammonium acetate is dissolved. Adjust pH to 5.0 (± 0.1) with glacial acetic acid. Transfer the solution into a 1000 mL volumetric flask, and fill to volume with HPLC-grade H₂O. Prepare as necessary and store refrigerated.

(2) 1.0 M formic acid solution

Dilute 3930 μ L of formic acid (96%) to 100 mL with HPLC grade water. Prepare as needed and store refrigerated.

(3) β -glucuronidase (*Helix Pomatia*, H1)/buffer solution

Prepare a fresh solution for each run. Add 0.030 g of β -glucuronidase (*Helix Pomatia*, H1 which has been stored frozen until use) to 7.5 mL of ammonium acetate buffer (pH 5.0 \pm 0.1) solution. Mix gently to prevent deactivation of the enzyme. 50 μ L of this enzyme/buffer solution will be used for incubation of each sample.

(4) HPLC Mobile Phase

HPLC grade water is used as mobile phase A (aqueous); HPLC grade MeOH is used as mobile phase B (organic) for both SPE and HPLC pumps. MeOH and water are stored at room temperature.

(5) Synthetic Urine

Prepare as needed and store in the refrigerator. Mix the reagents below, in the sequence shown, and fill up to 1 L with deionized water:

500 mL	Deionized water
3.8 g	Potassium Chloride
8.5 g	Sodium Chloride
24.5 g	Urea
1.03 g	Citric Acid
0.34 g	Ascorbic Acid
1.18 g	Potassium Phosphate
1.4 g	Creatinine
0.64 g	Sodium Hydroxide (add slowly)
0.47 g	Sodium Bicarbonate
0.28 mL	Sulfuric Acid

c. Standards Preparation

(1) Stock Solutions and Analytical Standard Solutions

Initial stock solutions were prepared by dissolving measured amounts of phenols in methanol. Serial dilutions of these stock solutions were made in methanol to create eleven mixed standard stock solutions containing all analytes of interest. 100- μ L aliquot of this mixed stock solution to 100 μ L urine will result in the desired concentration range.

(2) Internal Standard Solution

Initial stock solutions for all isotope labeled compounds were prepared by dissolving measured amounts of the solid compounds in MeOH. The internal standard working solution was prepared by diluting the stock solutions in MeOH, so that a 50- μ L aliquot in 100 μ L urine resulted in an appropriate concentration level for each compound. Both the native and the isotope labeled standard solutions were then dispensed into small vials, and stored frozen until use.

(3) Deconjugation Standard Solution

4-methylumbelliferyl sulfate, 4-methylumbelliferyl glucuronide, and $^{13}\text{C}_4$ -4-methylumbelliferone are used as deconjugation standards to monitor the extent of the enzymatic reaction. The individual stock solution is prepared by dissolving measured amounts of 4-methylumbelliferyl glucuronide, 4-methylumbelliferyl sulfate, and $^{13}\text{C}_4$ -4-methylumbelliferone in MeOH. The final deconjugation standard solution contains 4-methylumbelliferyl sulfate (0.5 ppm), 4-methylumbelliferyl glucuronide (0.5 ppm), and $^{13}\text{C}_4$ -4-methylumbelliferone (0.5 ppm), and is made by diluting the original stock solution with HPLC grade H_2O . Dispense the deconjugation standard solution into glass vials, and store refrigerated.

(4) MS Instrument Operational Check Standard

A reagent blank (QCB) that contains 50 μ L of the internal standard is used as the MS instrument check standard. This solution is used to check the sensitivity of the mass spectrometer before starting each run every day. The same sample can be also used to check the resolution of the HPLC system by checking the retention times of the two pairs of isomers included in the method.

(5) In-house Proficiency Testing (PT) Standards

Aliquots of each standard stock solution are added to 100 mL urine pools to produce PT standards of 3 different concentrations. The spiked pools are mixed overnight, aliquoted into vials, and frozen until needed. The PT standards are characterized by at least 20 repeat measurements to determine the mean and standard deviation for each analyte.

d. Materials

- 1) HPLC conical glass autosampler vials (1.5 mL, SUN-Sri, Rockwood, TN)
- 2) Tip ejector variable volume micropipettes (Wheaton, Millville, NJ), and disposable pipette tips (Rainin Instruments Co., Woburn, MA).
- 3) LiChrosphere RP-18 ADS cartridge (25-4mm, Merck GaA, Germany), and cartridge holder.

- 4) Chromolith Performance RP-18e (100-4.6mm, Merck GaA, Germany) HPLC column.
- 5) Assorted glassware.

e. Equipment

- 1) Agilent 1100 HPLC system (Agilent Tech., Wilmington, DE), which includes 2 binary pumps, 1 autosampler, and 1 column compartment with a 10-port switching valve.
- 2) Surveyor Plus liquid chromatograph autosampler (Thermo Electron Corp., San Jose, CA)
- 3) High pressure mixing Tee.
- 4) Applied Biosystems API 4000 mass spectrometer (Applied Biosystems, Forster City, CA).
- 5) Sartorius Genius Series ME models electronic analytical & semi-microbalances (Sartorius AG, Goettingen, Germany).
- 6) Sartorius top-loading balance (Sartorius AG, Goettingen, Germany).
- 7) pH meter (Corning pH/ion analyzer 455, Corning, New York).
- 8) Allegra 6 Centrifuge (Beckman Coulter)
- 9) Vortexer (Fisher, Genie 2).
- 10) Magnetic Stirrer (Corning).

f. Instrumentation

1) On line SPE-HPLC-MS/MS Configuration

The on-line SPE-HPLC-MS/MS system was constructed from several Agilent 1100 modules coupled to a triple quadrupole API 4000 mass spectrometer equipped with an APCI interface.[27,28] The on-line SPE-HPLC system consisted of two binary pumps with degassers, an autosampler with a 900- μ L injection loop, a high pressure mixing Tee, and one column compartment with a ten-port switching valve. The mass spectrometer and HPLC modules were programmed and controlled using the Analyst 1.4 software (Applied Biosystems, Ontario, Canada). The SPE column was a LiChrosphere RP-18 ADS (25 \times 4 mm, 25 μ m particle size, 60 Å pore size, Merck KGaA, Germany), and the HPLC columns were two Chromolith™ Performance RP-18 (100 \times 4.6 mm; Merck KGaA, Germany).

The procedure for extracting the phenols from the urine involves concurrent SPE and HPLC-MS/MS cycles (Table 1). While the autosampler and Pump 1 are used for the SPE of one sample, the ten-port switching valve, Pump 2 and the mass spectrometer are used to acquire data from the previous sample. The HPLC-MS/MS acquisition method is built in 'no sync' mode (i.e., all devices are programmed to start at the same time). The different combinations of autosampler valve and switching valve positions, and the timing of the gradient of the two binary pumps divide into six periods the concurrent regeneration and

equilibration of the SPE column for the clean-up of the next sample, and the collection of the HPLC-MS/MS data (Table 1, Figure 1).

Table 1. Concurrent SPE clean-up and HPLC-MS/MS analysis time line

Period			1	2	3	4	5	6	
Time (min)		0	0.1-2	2 - 5	5 - 9	9 - 15.5	15.5-18.8	18.8 - 21	
SPE of Sample N+1		Start	Analyte Transfer and dilution	Regenerate SPE column	Equilibrate SPE column	Sample loading	SPE column Wash	Stop Pump 1	
	Autosampler valve	1-2	1-2	6-1	6-1	1-2	6-1	1-2	
	Pump 1								
	mL/min	0	0.25	1.0	1.0	1.0	1.0	0	
	MeOH%		20%	100%	20%	20%	20%	20%	
HPLC of Sample N			Analyte Transfer	HPLC separation and MS/MS acquisition				Equilibrate Pump 2	
	Ten-port valve	10-1	1-2	10-1				10-1	
	Pump 2			0.75 HPLC gradient elution				0.75	
	mL/min	0.5	0.5	0.75				0.75	
	MeOH%	50%	50%	Time (min)	2.1	10	17	18.5	50%
				MeOH%	50	65	100	100	

First, the analytes from the previously injected sample that had been retained by the SPE column are eluted using 50% MeOH:50% water at 0.5 mL/min provided by pump 2. Through a mixing Tee, the 0.5 mL/min SPE elute is diluted with 20% MeOH:80% water (0.25 mL/min) provided by pump 1, and then, the analytes are transferred to the HPLC column (Figure 1A, Table 1).

Figure 1. Tubing set-up for the autosampler and ten-port valves with configurations for 3 selected periods of Table 4: A) Analyte transfer and dilution (Period 1), B) Sample loading (Period 4) and C) SPE column wash (Period 5).

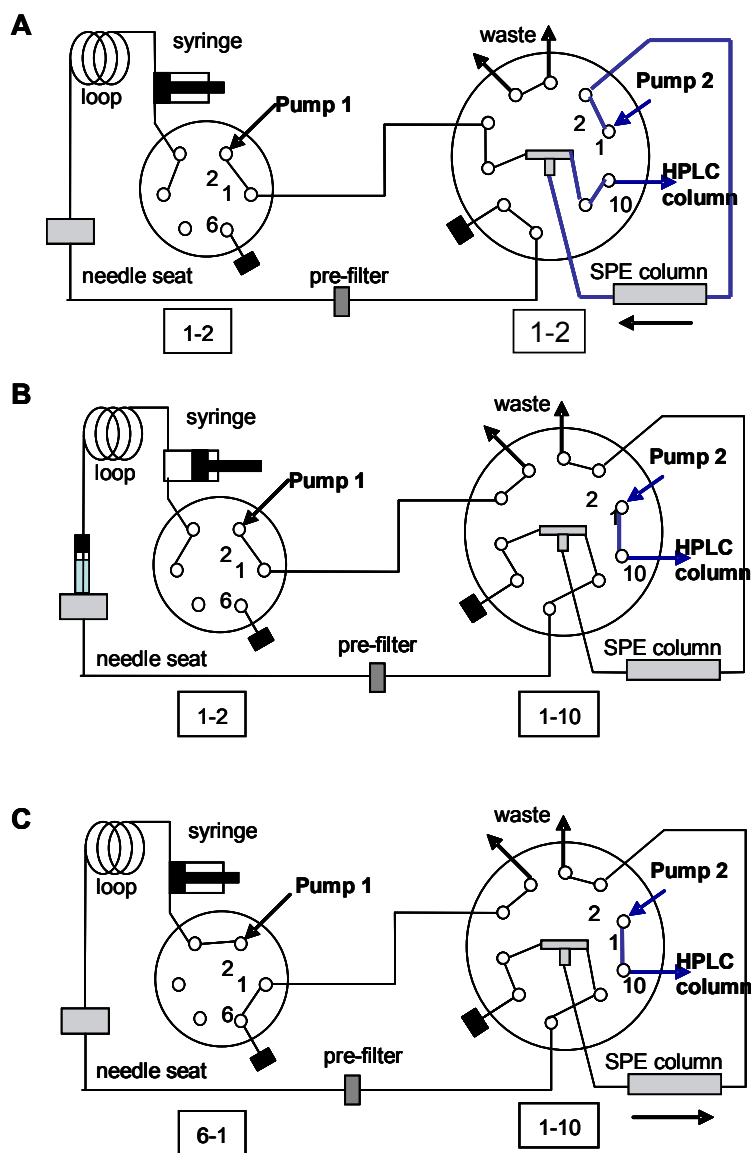

At 2 minutes, the collection of the HPLC-MS/MS data starts while the SPE column is regenerated and equilibrated with 100% MeOH (1 mL/min for 3 minutes) and 20% MeOH:80% water (1 mL/min for 4 minutes), respectively. The injection (1 mL of sample containing 100 μ L urine) is programmed as two sequential “400 μ L sample draw” and “400 μ L eject into the needle seat” commands in Analyst 1.4. Tube connections inside the autosampler are modified in-house to connect the needle seat directly to the SPE column. In this way, the execution of the “eject into the needle seat” command results in loading of the sample directly onto the SPE column by the autosampler syringe (Figure 1B). A needle rinse, performed by lowering the needle into a vial containing MeOH, is included before the second ejection. After the sample loading is complete, the SPE column is washed for 3 minutes while unbound urine components are carried to waste by a flow (1 mL/min) of 20% MeOH:80% water (Figure 1C, Table 1). The collection of HPLC-MS/MS data lasts 16.6 min, after

which the HPLC pump is equilibrated for 2.2 minutes for the next elution cycle while the flow through the SPE column is brought to a complete stop (Table 1).

2) Mass Spectrometry

The API 4000 mass spectrometer is used in negative ion APCI mode. Laboratory-grade air is used for both auxiliary gas and nebulizing gas. The negative fragment ions used for quantification and the retention time for the analytes are listed in Table 2.

Table 2. Analyte retention time (RT) and precursor ions -> product ion transitions monitored for quantitation (and confirmation) of native compounds and corresponding internal standards.

Analyte	RT (min)	Precursor Ion -> Product Ion (m/z)	
		Native Analyte	Internal Standard
Methyl paraben	9.02	151->92 (136)	155->96
Ethyl paraben	10.99	165->92 (137)	169->96
Bisphenol A	13.6	227->133 (212)	239->139
Propyl paraben	13.64	179->92 (136)	183->96
2,5-dichlorophenol	14.2	161->125 (163->125)	167->131
2,4-dichlorophenol	14.8	161->125 (163->125)	167->131
Ortho-phenylphenol	15.1	169->115 (141)	175->121
Butyl paraben	15.99	193->92 (136)	197->96
2,4,6-trichlorophenol	16.9	195->159 (197->161)	201->165
2,4,5-trichlorophenol	17.4	195->159 (197->161)	201->165
Benzophenone-3	17.8	227->183 (211)	231->183
Triclosan	19.1	161->125 (163-125)	167->131
4-t-Octyl phenol	19.3	205->133	209->137

7. Calibration and Calibration-Verification Procedures

a. Mass Spectrometer

At least once per year, the mass spectrometer is calibrated and tuned using a polypropylene glycol (PPG) solution by a qualified service engineer.

b. Calibration Verification

- 1) Calibration verification is not required by the manufacturer. However, it should be performed after any substantive changes in the method or instrumentation (e.g., new internal standard, change in instrumentation), which may lead to changes in instrument response, have occurred.
- 2) All calibration verification runs and results shall be appropriately documented.
- 3) According to the updated Clinical Laboratory Improvement Amendments (CLIA) regulations from 2003 (<http://www.cms.hhs.gov/CLIA/downloads/6065bk.pdf>), the requirement for calibration verification is met if the test system's calibration procedure includes three or more levels of calibration material, and includes a low, mid, and high value, and is performed at least once every six months.
- 4) All of the conditions above are met with the calibration procedures for this method. Therefore, no additional calibration verification is required by CLIA.

c. Proficiency Testing

- (1) Three pools of PT samples, which encompass the entire linear range of the method, are prepared in-house as described in the standard preparation section. Characterization of PT materials requires at least 20 separate determinations. Once the PT pools are characterized, the mean concentration and standard deviation of the PT materials are forwarded to a DLS representative responsible for executing the PT program (PT administrator). These PT samples are blind-coded by the PT administrator and returned to the laboratory staff for storage.
- (2) Proficiency testing should be performed a minimum of once per 6 months. When proficiency testing is required, the laboratory supervisor or his/her designee will notify the PT administrator who will randomly select five PT materials for analysis. PT samples will be analyzed in exactly the same way as routine unknown samples. Following analysis, the results will be forwarded directly to the PT administrator for evaluation. A passing score is obtained if at least four of the five samples fall within the prescribed limits established by the PT administrator. The PT administrator will notify the laboratory staff of the PT results (i.e. pass/fail).
- (3) All proficiency results shall be appropriately documented.
- (4) In addition to the in-house PT program, we are participating in the ongoing German External Quality Assessment Scheme (G-EQUAS) organized and managed by the Institute and Outpatient Clinic for Occupational, Social and Environmental Medicine of the University of Erlangen-Nuremberg (Erlangen, Germany). A minimum of once per year since 2006, we analyze two reference urine samples fortified with 2,4,6-TCP and 2,5-DCP. The program, evaluation, and certification are based on the guidelines of the German Federal Medical Council (<http://www.g-equas.de/>).

d. Analytes nomenclature and structures

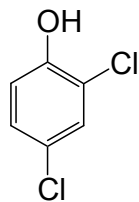

2,4-dichlorophenol (24-DCP)

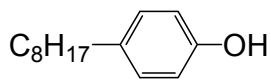

t-octylphenol (t-OP)

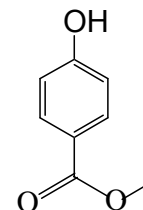

Methyl Paraben

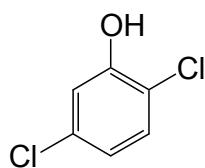

2,5-dichlorophenol (25-DCP)

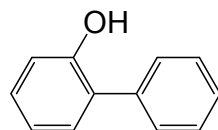

o-phenyl-phenol (o-PP)

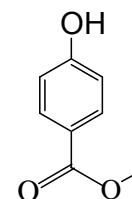

Ethyl Paraben

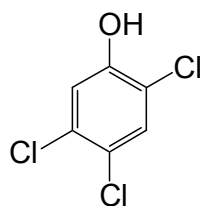

2,4,5-trichlorophenol (245-TCP)

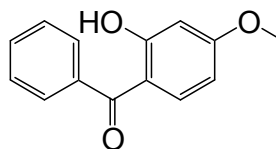

bezophenone-3 (BP-3)

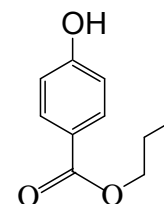

Propyl Paraben

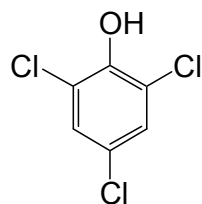

2,4,6-trichlorophenol (246-TCP)

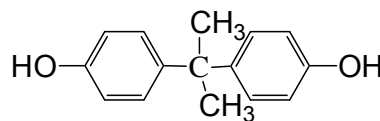

bisphenol A (BPA)

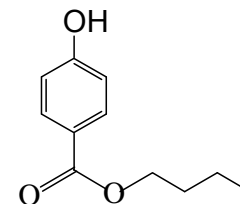

Butyl Paraben

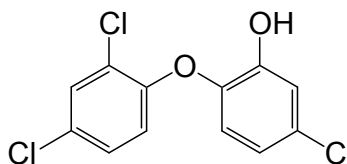

triclosan

8. Operating Procedures; Calculations; Interpretation of Results

a. Sample and standards preparation

(1) Preliminaries

- (a) Remove urine samples, standard stock solutions, deconjugation standard solution and quality control (QC) materials from the freezer or refrigerator.
- (b) Prepare enzyme/buffer solution. Add 0.030 g of β -glucuronidase (*Helix Pomatia*, H1) to 7.5 mL of ammonium acetate buffer (pH 5.0) solution. Gently mix the enzyme and transfer the enzyme solution to Reservoir B of the Surveyor autosampler.
- (c) Load 20 mL of 1M formic acid to Reservoir C of the Surveyor autosampler.
- (d) Fill reservoir D with MeOH.
- (e) Load 6 mL of the deconjugation standard solution onto Reservoir A of the Surveyor autosampler.
- (f) Load an empty autosampler vial without the lid onto A1 position of the Surveyor autosampler.
- (g) Fill the wash bottle of the Surveyor autosampler with HPLC grade water.

(2) Preparation of samples with Surveyor Plus Autosampler

- (a) Include 50 unknown samples, 11 standards, 2 QC blanks, 2 empty vials (dummies), 2 QCs of low concentration (QCL) and 2 QCs of high concentration (QCH) for each batch. Label the autosampler vials. Print out the Sample Log Sheet with Sample Name.
- (b) Add 50 μ L of internal standard mix to the autosampler vial.
- (c) Add 100 μ L of urine or QC sample. For standards, add 100 μ L of standard stock solution, and for the reagent blank (QCB), add 100 μ L of HPLC grade water.
- (d) The vials are capped with Teflon-lined screw caps, vortexed, and loaded onto the sample trays of the Surveyor autosampler.
- (e) The autosampler tray is set at 37 °C for incubation of the samples.
- (f) 50 μ L of deconjugation standard solution and 50 μ L of enzyme solution are automatically added to each vial.
- (g) The mixing step is carried on by withdrawing 100 μ L of air from the empty vial at position A1 and dispensing 100 μ L of air into each sample. The regular mixing command could cause carryover problems and therefore can't be used.
- (h) Incubate the samples for 4 hrs. The Surveyor is programmed so when 69 samples are included in one batch, each sample will be incubated for 4 hrs. When fewer than 69 samples are included in

one batch, load empty vials on to the sample tray as dummies to make a batch of at least 69 samples.

- (i) After incubation, the enzyme activity is stopped by automatically adding 80 μL of 1M formic acid, and 670 μL of H_2O .
- (j) The sample tray temperature is set to 0°C after preparation of the whole set.

(3) Prepare the samples for LC/MS/MS analysis

Take out the samples from the Surveyor autosampler. Vortex, and centrifuge the samples at 2500 RPM for 10 min, and then transfer the samples to the Agilent autosampler for on-line SPE-HPLC-MS/MS analysis.

b. Analysis

(1) Check out the LC/MS interface

- (a) If the instrument is in ready mode, wait until the interface cools down. When the interface is cold enough, take out the capillary. Rinse the capillary with MeOH, sonicate the capillary in MeOH for 20 min if necessary. If needed, take off the interface house, and wipe the skimmer plate.
- (b) Open the rough pump cabinet, check for oil leaks and unusual noise. Report anything unusual.

(2) Check out the LC system

- (a) Refill the mobile phase for both HPLC and SPE pumps directly from the original 4 L brown MeOH reagent bottles or water deionizer so the possibility of solvent contamination from a third container is eliminated.
- (b) Change the two pre-filters, which are located before SPE and HPLC columns, before each batch of samples.
- (c) Make sure the proper Acquisition Method and Vial Position are entered, and then submit the batch. Open a window to display the chromatogram after the first QCB has been acquired and note intensities of specific ions. If peaks appear distorted (long tail, after-peak, too broad etc.) check with the lab supervisor or his/her designee.

(3) Building the batch files

- (a) From Excel, open up the text file containing the batch table created by Access. This file should not require any editing. Save the edited table into the text file named import.txt into the batch directory (overwrite). Remember to CLOSE THE FILE IN EXCEL!! Go to the analyst and import the import.txt file (In Batch File: Add Batch, Add Sample, Import from File (select appropriate text file), then chose G1329A Autosampler).

- (b) Check and make sure that the proper Acquisition Method and Quantitation Method are entered.
- (c) In the batch file, always submit a dummy sample first with the vial position of the first real sample. Then submit the batch file with the vial position of each sample shifting by 1. For example, if the sample is in position N, then in the batch file, the vial position for this sample should be N+1. Remember to put an empty vial right next to the last sample on the autosampler tray, so when the MS acquires data for the last sample, the autosampler will withdraw the sample from this empty vial, otherwise the system will stop and display an error message (missing vial). The reasons for building the sequence file this way have been explained before in Section of Instrumentation/On line SPE-HPLC-MS/MS Configuration.

c. Processing data

(1) Quantification

All raw data files are analyzed using the Quantitation Wizard application in Analyst, which allows both automatic and manual peak selection, and area integration. All information, including sample name, sample ID and calculated concentration are exported into a tab delimited text file with the name YYYY-MMDD.txt.

(2) Importing Data into the database

The YYYY-MMDD.txt tab-delimited file is read into the Access database. No prior editing is required.

(3) Statistical Analysis and Interpretation of Data

Data are exported from the Access database to a fixed ASCII text file and imported into SAS. For statistical analysis the concentrations calculated by Analyst will be used. However, standard curve generation, QC analysis, blank analysis, limit of detection determination, unknown calculations, and data distribution programs have been created and may be executed in SAS when this information is needed.

d. Replacement and periodic maintenance of key components

(1) API 4000 Sciex Mass Spectrometer

At least once a year, a preventative maintenance of the system is performed by a qualified service engineer. In addition, to ensure proper performance of the system, a periodic maintenance of the system (e.g., cleaning the APCI probe, the corona needle, and the curtain plate) may be required.

- (a) When a partial blockage of the vacuum is suspected, the orifice is probed with a syringe-cleaning wire.

- (b) Cleaning the spray shield and the entrance end of the heated capillary, described in the Sciex API 4000 Hardware Manual, is performed as needed. First, wash with a solution of water: methanol (1:1), second with 100 % methanol, then wipe it using flake free paper wipes.
- (c) The pump oil is changed approximately every six months as part of the periodic maintenance conducted by the service engineer.

(2) Regeneration of HPLC columns

HPLC columns are regenerated as needed with a proteinase preparation to remove any protein that might bind to the column. The procedure for the column regeneration is as follows:

- (a) Wash the columns with 100 %ACN at a flow rate of 1.5 mL/min for 10 min.
- (b) Wash the columns with 100 % H₂O at a flow rate of 1.5 mL/min for 10 min.
- (c) Saturate the columns with proteinase at a flow rate of 1.0 mL/min for 10 min.
- (d) Seal the columns with the caps.
- (e) Incubate the columns @ 65 °C (±10°) oven for at least 30 min.
- (f) Wash the columns with H₂O at a flow rate of 1 mL/min for 10 min.
- (g) Wash the columns with ACN at a flow rate of 1 mL/min for 10 min.
- (h) Check the column by running the instrument check sample.

(3) Agilent 1100 on line SPE-HPLC

- (a) At least once a year, a preventative maintenance of the system is performed by a qualified service engineer.
- (b) The solvent frits from the HPLC and SPE pumps are replaced periodically as a preventive measure to avoid high pressure problems. Additional maintenance of the on line SPE-HPLC is only necessary if a decrease in the system performance (low sensitivity, low resolution, and/or low S/N ratio) is detected.
- (c) The HPLC columns need to be replaced if the chromatographic resolution begins to fail. Since there are two HPLC columns used in tandem, we suggest replacing one HPLC column at a time before deciding whether to replace either one or both columns.
- (d) If the analyte peaks start to tail, the problem may be with the HPLC or SPE columns. Check each one individually for peak shape and replace as needed.
- (e) If high pressure error messages are observed, systematically check the purge valve frit, the pre-filter, analytical column frit, HPLC lines, needle seat, or injector components to find out the source of the plug and replace the part with a new one.
- (f) Reestablishment of performance and calibration. Each time the system is down for cleaning or maintenance, a MS operational check standard is analyzed to assess the system performance.

For the mass spectrometer rerun of the system may or may not be necessary. If the instrument does not pass this test, then the instrument is retuned using PPGs as described previously.

9. Reportable Range of Results

The linear range of the standard calibration curves and the method limit of detection (LOD) determine the reportable range of results. The reportable range must be within the range of the calibration curves. However, samples with analytical data values exceeding the highest reportable limit may be diluted, re-extracted, and reanalyzed so that the measured value will be within the range of the calibration.

a. Linearity Limits

The high linearity limit is determined by the highest standard analyzed in the method. The low end of the linear range is limited by the method LOD. Samples whose concentrations are below the method LOD are reported as non-detectable. Calibration curves with a minimum of nine standard points are calculated for each batch from the area ratios ([analyte peak area]/[internal standard peak area]) from freshly analyzed standards and linear regression analysis where each concentration is weighed by $1/[\text{measured concentration}]$. Acceptable calibration curves have correlation coefficients normally greater than 0.98; the lowest calibration point should be below the LOD and the highest calibration point has to be above the expected range of results for most samples. Samples with concentrations exceeding the highest calibration standard are re-extracted using less urine.

b. Analytical sensitivity

The limits of detection (LOD) are defined for each analyte by repetitive analysis of low level standards by the calculation of the standard deviation at zero concentration (S_0).^[29] The formal limit of detection is defined as $3S_0$. The functional LOD is equal to the formal LOD unless the lowest point in the calibration curve is higher, then the functional LOD is defined as the lowest standard concentration used in the calibration curve. Table 3 summarizes the linear range for each analyte in urine.

Table 3. Linear Range of the calibration curve

Analyte	Linear range (ng/mL) LOD - Highest Standard
Bisphenol A	0.4-100
4-tert-octylphenol	0.2-100
Triclosan	2.3-1000
Benzophenone-3	0.4-1000
2,4-dichlorophenol	0.2-100
2,5-dichlorophenol	0.2-1000

2,4,5-trichlorophenol	0.1-100
2,4,6-trichlorophenol	0.5-100
ortho-phenylphenol	0.1-100
Methyl paraben	1.0-1000 *
Ethyl paraben	1.0-500 *
Propyl paraben	0.2-1000 *
Butyl paraben	0.2-500 *

* The linear range of the parabens for Q1 is LOD-100 ppb. Use Q2 for quantitation when the calculated Q1 concentration is above 100 ppb.

c. Accuracy

The accuracy is calculated from repeated analyses of synthetic urine spiked with standards 3, 5 and 7. We use the isotope-dilution technique with isotope-labeled phenols, which allows for automatic recovery correction for each sample and improves the method precision and accuracy (Tables 4 and 5).

Table 4. Spiked recoveries (%) of the standards

Analyte	Standard 3	Standard 5	Standard 7
Bisphenol A	113	102	98
4-tert-octylphenol	129	104	102
Triclosan	106	97	108
Benzophenone-3	99	107	96
2,4-dichlorophenol	102	101	96
2,5-dichlorophenol	132	122	107
2,4,5-trichlorophenol	102	98	96
2,4,6-trichlorophenol	115	95	94
ortho-phenylphenol	113	108	112
Methyl paraben	98	101	97
Ethyl paraben	99	106	98
Propyl paraben	106	109	100
Butyl paraben	97	105	99

d. Precision

The precision of this method is reflected in the variance of two quality control (QC) pools over time (Table 5). The coefficient of variation (CV) of repeated measurements of these QC pools is used to estimate the method precision. The QC low concentration ranges from 2 to 27 ng/mL; for the QC high, the concentration ranges from 6 to 74 ng/mL. Table 5 lists the CV % for QCL and QCH for each analytes.

Table 5. Precision at two concentration levels using urine QC pools

Analyte	QC High		QC Low	
	Mean	CV%	Mean	CV%
Bisphenol A	9.89	11.2	3.02	12.6
4-tert-octylphenol	6.12	19.1	2.16	26.2
Triclosan	63.48	12.5	26.46	14.9
Benzophenone-3	61.22	9.6	16.39	11.1
2,4-dichlorophenol	13.27	9.1	1.94	13.3
2,5-dichlorophenol	73.42	6.0	5.56	10.7
2,4,5-trichlorophenol	13.51	7.6	2.76	8.6
2,4,6-trichlorophenol	20.39	11.5	6.85	16.5
ortho-phenylphenol	10.27	11.4	2.02	14.9
Methyl paraben	53.82	6.3	9.00	10.5
Ethyl paraben	20.80	7.4	5.15	15.0
Propyl paraben	26.40	6.3	6.34	9.3
Butyl paraben	10.48	6.1	2.17	10.1

e. Analytical Specificity

The method that requires that the analytes 1) coelute with the corresponding isotope labeled internal standard analog; 2) elute at a specific retention time; 3) have precursor ions with specific mass/charge ratios; and 4) have two specific product ions formed from the precursor ion with specific mass/charge ratios. The quantitation and confirmation ions for each analyte are listed in Table 2.

f. Deconjugation Optimization

Accurate quantification of phenol metabolites urinary concentrations assumes complete hydrolysis of their conjugated species. Therefore, the time required for enzyme-mediated deconjugation was optimized. A time course experiment was conducted with urine containing conjugated bisphenol A (unpublished results). This experiment revealed that the incubation of a sample with β -glucuronidase/sulfatase for a minimum of 4 hours resulted in quantitative deconjugation.

10. QC Procedure

a. QC Materials

Quality control (QC) materials are prepared in bulk from urine pools collected from several anonymous donors. These QC samples are analyzed along with

unknown samples to monitor for accuracy and precision throughout the analytical run.

b. QC Pools

The QC pools were mixed uniformly, and divided into two subpools. The subpools were enriched with phenols as needed to afford low concentration (QCL, ~ 2-27 ng/mL) and high concentration (QCH, ~ 6-74 ng/mL) subpools. The pools were dispensed into sample vials and frozen until needed.

c. Characterization of QC Materials

The QC pools were characterized to define the mean and the 95% and 99% control limits of phenols concentrations from 60 QCL and 60 QCH runs over 3 weeks (Table 5). In each run, one pair of QCL and one pair of QCH materials were analyzed and averaged. Using the pair average value from the 60 runs, we calculated the mean, and upper and lower 99% and 95% control limits.

d. Use of Quality Control Samples

Each analytical run consists of 56 samples: 2 QCL, 2 QCH, 2 reagent blanks, and 50 unknowns. The concentrations of the two QCH and the two QCL are averaged to obtain one measurement of QCH and QCL for each batch.

e. Final evaluation of Quality Control Results

Standard criteria for run rejection based on statistical probabilities are used to declare a run either in-control or out-of-control [30]. When using 2 QC pool levels per run, the rules are:

For 1 QC result per pool

- 1) If both QC run results are within $2S_i$ limits, then accept the run.
- 2) If 1 of the 2 QC run results is outside a $2S_i$ limit - reject run if:
 - Extreme Outlier – Run result is beyond the characterization mean $\pm 4S_i$
 - 1 3S Rule – Run result is outside a $3S_i$ limit
 - 2 2S Rule – Both run results are outside the same $2S_i$ limit
 - 10 X-bar Rule – Current and previous 9 run results are on same side of the characterization mean
 - R 4S Rule – Two consecutive standardized run results differ by more than $4S_i$ (standardized results are used because different pools have different means). Since runs have single measurements per pool for 2 pools, comparison of results for the R 4S rule will be with the previous result within run or the last result of the previous run.

For 2 or more QC results per pool

- 1) If both QC run means are within $2S_m$ limits and individual results are within $2S_i$ limits, then accept the run.
- 2) If 1 of the 2 QC run means is outside a $2S_m$ limit - reject run if:
 - Extreme Outlier – Run mean is beyond the characterization mean $\pm 4S_m$
 - 1 3S Rule – Run mean is outside a $3S_m$ limit

- 2 2S Rule – Both run means are outside the same $2S_m$ limit
- 10 X-bar Rule – Current and previous 9 run means are on same side of the characterization mean
- 3) If one of the 4 QC individual results is outside a $2S_i$ limit - reject run if:
 - R 4S Rule – Within-run ranges for all pools in the same run exceed $4S_w$ (i.e., 95% range limit). Since runs have multiple measurements per pool for 2 pools, the R 4S rule is applied within runs only.

Abbreviations:

S_i = Standard deviation of individual results (the limits are not shown on the chart unless run results are actually single measurements).

S_m = Standard deviation of the run means (the limits are shown on the chart).

S_w = Within-run standard deviation (the limits are not shown on the chart).

11. Remedial Action if Calibration or QC Systems Fail to Meet Acceptable Criteria

If the QC systems or the calibrations failed to meet acceptable criteria, all operations are suspended until the source or cause of failure is identified and corrected. Check for any irregularities (i.e., low calibration curve regression coefficient, change in slope or intercept, high reagent blank concentration, low internal standard sensitivity, etc). If the source of failure is easily identifiable, for instance, a pipetting error, the problem is immediately corrected. Otherwise, fresh reagents are prepared and the mass spectrometer is cleaned. Before beginning another analytical run, several QC materials (in the case of QC failure) or calibration standards (in the case of calibration failure) are reanalyzed. After calibration or quality control has been reestablished, analytical runs may be resumed.

12. Limitations of Method; Interfering Substances and Conditions

Occasionally, the concentration of the analytes in urine is much higher than the highest standard in the calibration curves, and 100 μ L of urine may be too much to use. In this case, a smaller aliquot of urine can be used to successfully extract the analytes.

The procedure requires expensive instrumentation.

13. Reference Ranges (Normal Values)

The results from the National Health and Nutrition Examination Survey (NHANES) 1999-2002 and 2003-2004 will be used as the reference ranges among the general US population.

Table 6. Urinary concentrations (in ng/mL) of selected phenols for the U.S. population (NHANES 1999-2000, 2001-2002) [31] and (NHANES 2003-2004) [32-34]

Analytes	Years	Geometric mean	50 th percentile	75 th percentile	90 th percentile	N
2,4,5-TCP	1999-2000	-	<LOD	1.40	5.40	1998
	2001-2002	-	<LOD	<LOD	<LOD	2526
2,4,6-TCP	1999-2000	2.85	2.45	4.80	14.8	1989
	2001-2002	-	1.68	5.94	10.8	2503
OPP	1999-2000	0.494	0.49	0.85	1.46	1991
	2001-2002	-	<LOD	<LOD	0.57	2529
BPA*	2003-2004	2.6	2.7	5.4	10.4	2517
Triclosan	2003-2004	13.0	9.2	47.0	249.0	2517
BP-3	2003-2004	22.9	18.0	94.0	364.0	2517
Methyl paraben*		NA	43.9	NA	412	100
Ethyl paraben*		NA	1.0	NA	25.1	100
Propyl paraben*		NA	9.1	NA	144	100
Butyl paraben*		NA	0.5	NA	14.5	100

*Data are from 100 adults.[35]

14. Critical-Call Results (“Panic” Values)

Insufficient data exist to correlate urinary phenol concentrations with serious health effects in humans. Therefore, critical call values have not been established.

15. Specimen Storage and Handling During Testing

Stability studies suggest that the samples remain stable at room temperature for up to one week if the concentrations of total species (free +conjugates) will be measured.[36]

16. Alternate Methods for Performing Test and Storing Specimens if Test System Fails

Validated SPE/derivatization-GC/MS analysis protocols are available on site if necessary.[37] However, since the GC/MS method is no longer maintained, it would be preferable to wait until the LC-MS/MS system is fixed.

17. Test-Result Reporting System; Protocol for Reporting Critical Calls (If Applicable)

- a. The data from analytical runs of unknowns are initially reviewed by the laboratory supervisor. The supervisor provides feedback to the analyst and/or his/her designee and requests confirmation of the data as needed.

- b. The Quality Control officer reviews each analytical run and identifies the quality control samples within each analytical run and determines whether the analytical run is performed under acceptable control conditions.
- c. One of the Division statisticians reviews and approves the quality control charts pertinent to the results being reported.
- d. If the quality control data are acceptable, the laboratory supervisor or his/her designee generates a memorandum to the Branch Chief, and a letter reporting the analytical results to the person(s) who requested the analyses to be signed by the Division Director.
- e. The data are sent (generally electronically by e-mail) to the person(s) that made the initial request.
- f. All data (chromatograms, etc.) are stored in electronic format.
- g. Final hard copies of correspondence are maintained in the office of the Branch Chief and/or his/her designee and with the quality control officer.

18. Transfer or Referral of Specimens; Procedures for Specimen Accountability and Tracking

Standard record keeping systems (i.e. notebooks, sample logs, data files, creatinine logs, demographic logs) should be employed to keep track of all specimens. Specimens will only be transferred or referred to CLIA certified laboratories. One spreadsheet form (CLIA Specimen Tracking Records) with information for receiving/transferring specimens is kept in the laboratory. In this form, the samples received are logged in when received and when stored/transferred after analysis. For NHANES samples, the person receiving the specimens signs and dates the shipping manifests. The shipping manifests for NHANES and other samples are kept in a binder in the Laboratory.

19. Summary Statistics and QC Graphs

A. Triclosan

Summary Statistics for Urinary Triclosan by Lot

Lot	N	Start Date	End Date	Mean	Standard Deviation	Coefficient of Variation
LQC-122005	66	6/20/2006	2/8/2007	26.147	2.512	9.6
HQC-122005	66	6/20/2006	2/8/2007	63.513	5.358	8.4

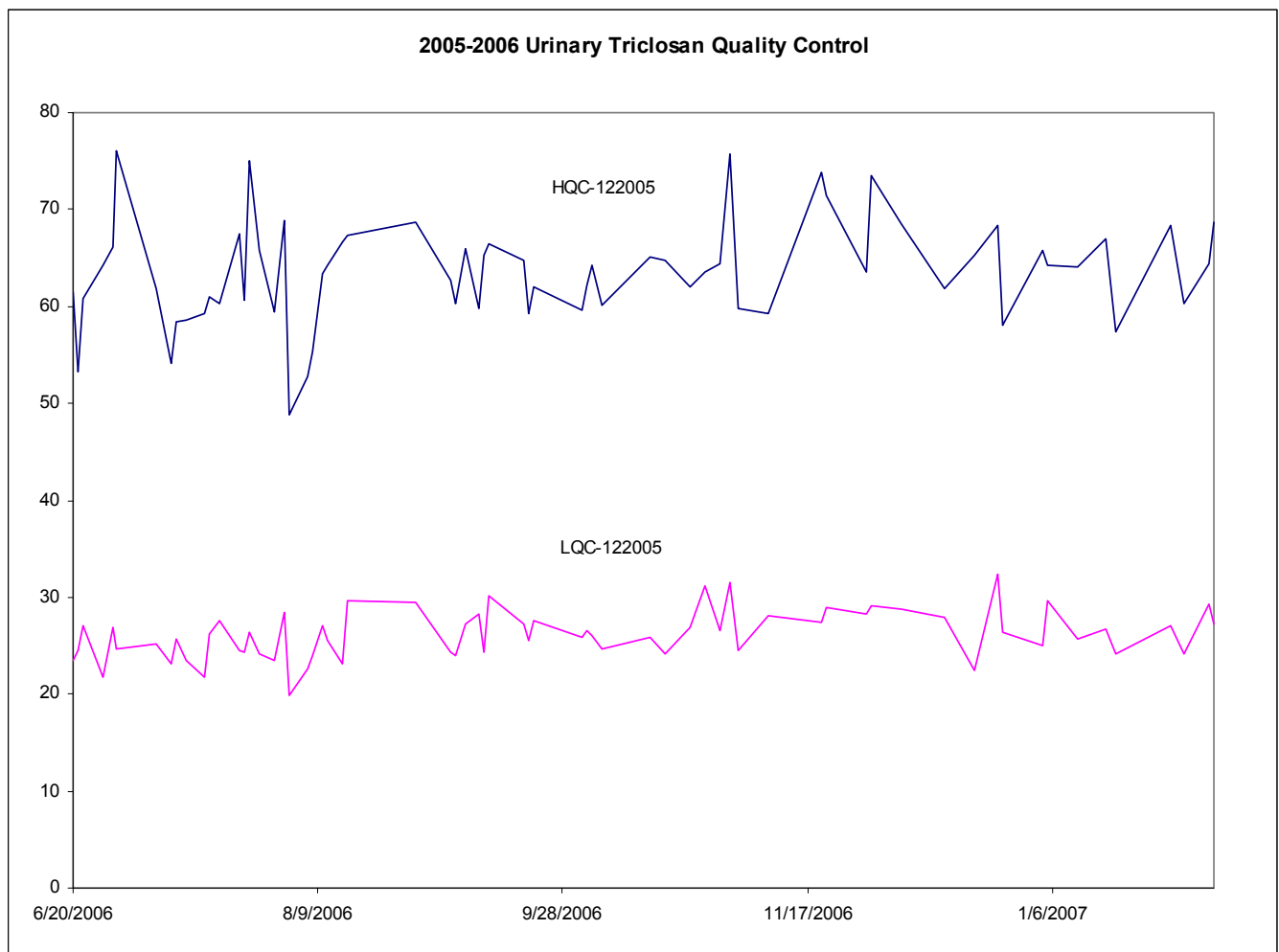

B. 4-tert-octylphenol

Summary Statistics for Urinary 4-Tert-Octylphenol by Lot

Lot	N	Start Date	End Date	Mean	Standard Deviation	Coefficient of Variation
LQC-122005	55	6/20/2006	2/8/2007	1.950	0.375	19.2
HQC-122005	55	6/20/2006	2/8/2007	5.380	0.718	13.3

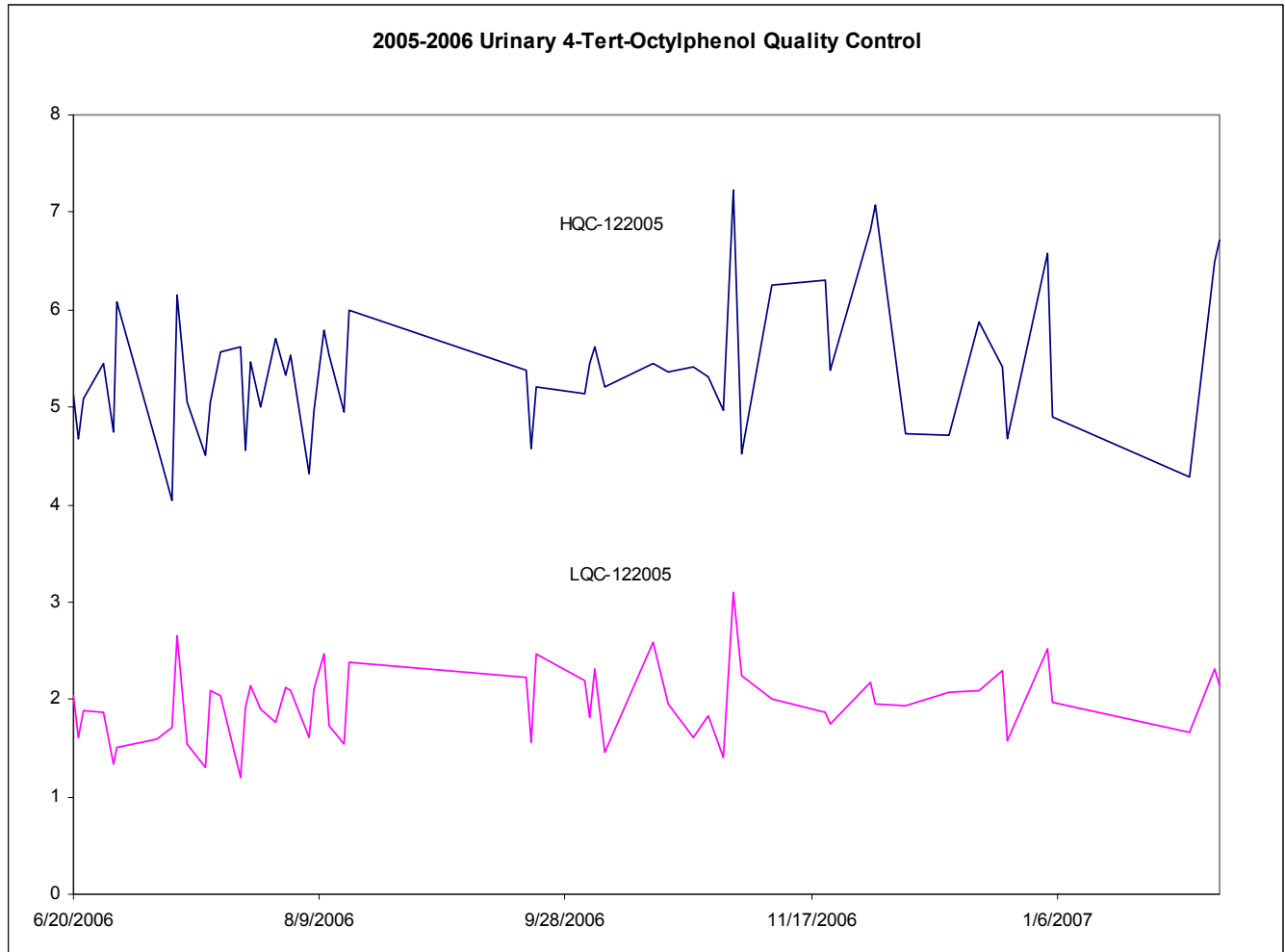

C. 2-Hydroxy-4-methoxybenzophenone (Benzophenone-3)

Summary Statistics for Urinary Benzophenone-3 by Lot

Lot	N	Start Date	End Date	Mean	Standard Deviation	Coefficient of Variation
LQC-122005	66	6/20/2006	2/8/2007	15.886	1.112	7.0
HQC-122005	66	6/20/2006	2/8/2007	60.845	4.035	6.6

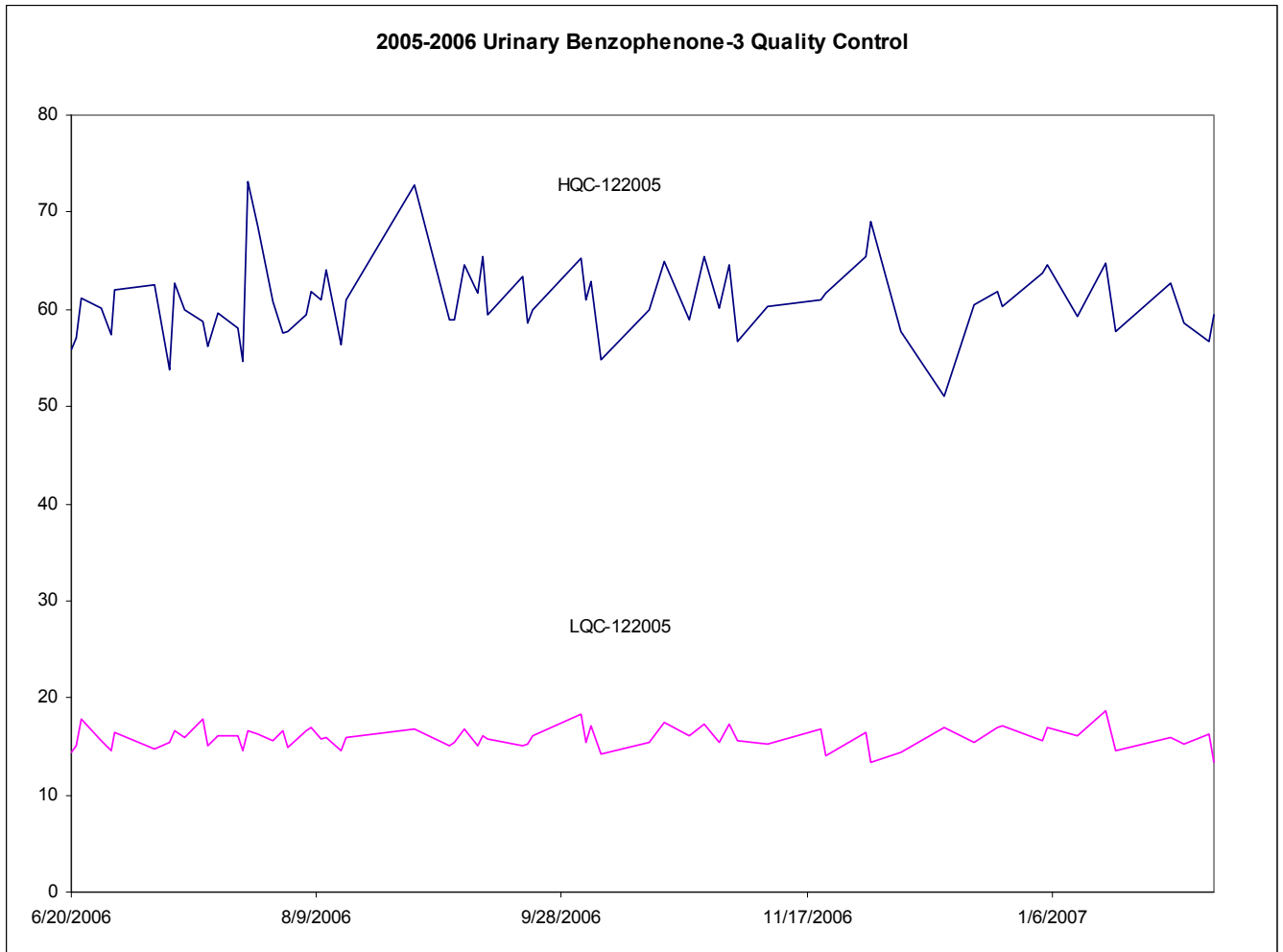

D. Bisphenol A

Summary Statistics for Urinary Bisphenol A by Lot

Lot	N	Start Date	End Date	Mean	Standard Deviation	Coefficient of Variation
LQC-122005	57	6/20/2006	2/7/2007	2.867	0.198	6.9
HQC-122005	57	6/20/2006	2/7/2007	9.466	0.688	7.3

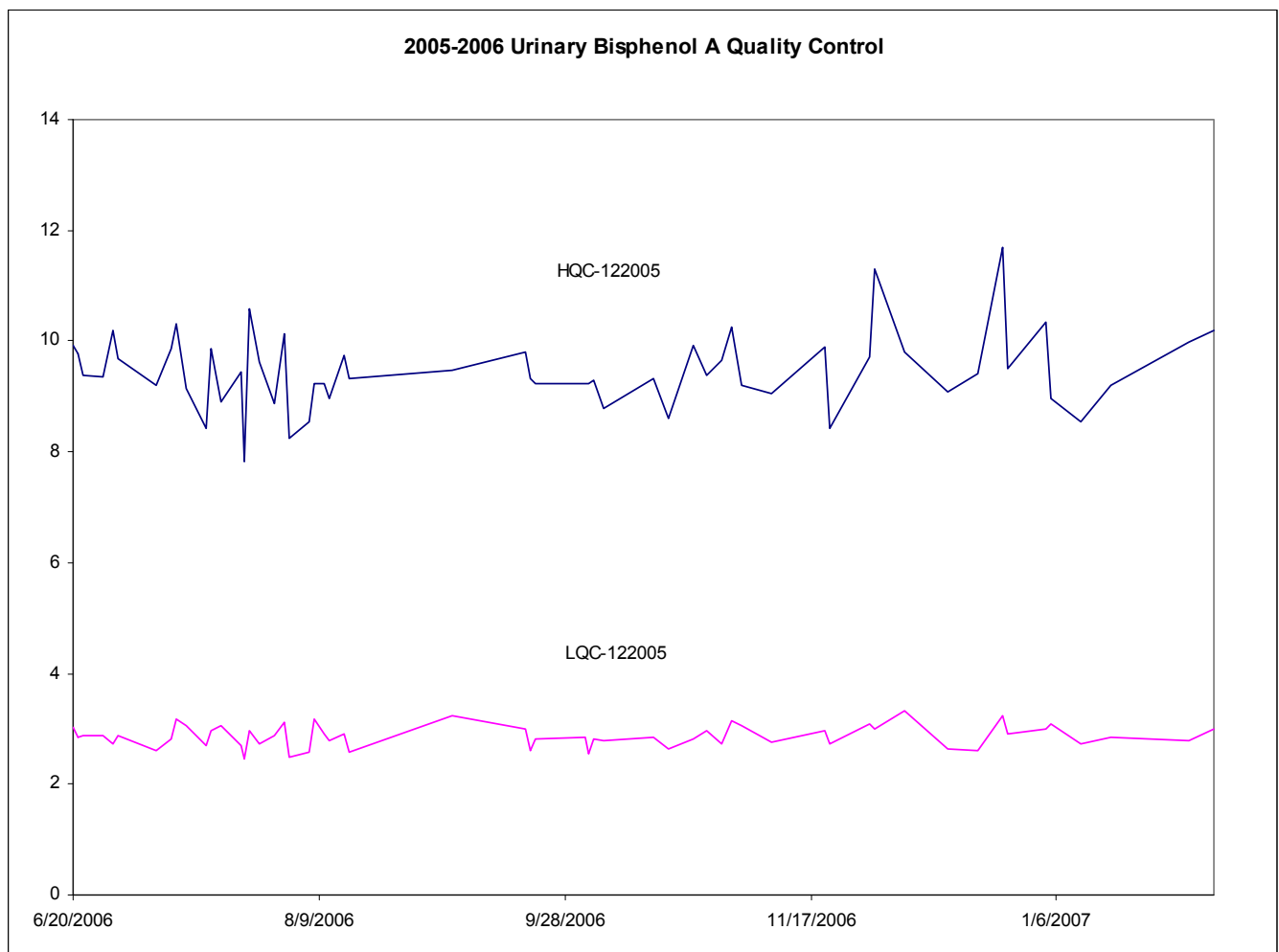

D. Butyl paraben

Summary Statistics for Urinary Butyl Paraben by Lot

Lot	N	Start Date	End Date	Mean	Standard Deviation	Coefficient of Variation
LQC-122005	55	6/20/2006	2/7/2007	2.047	0.119	5.8
HQC-122005	55	6/20/2006	2/7/2007	10.504	0.586	5.6

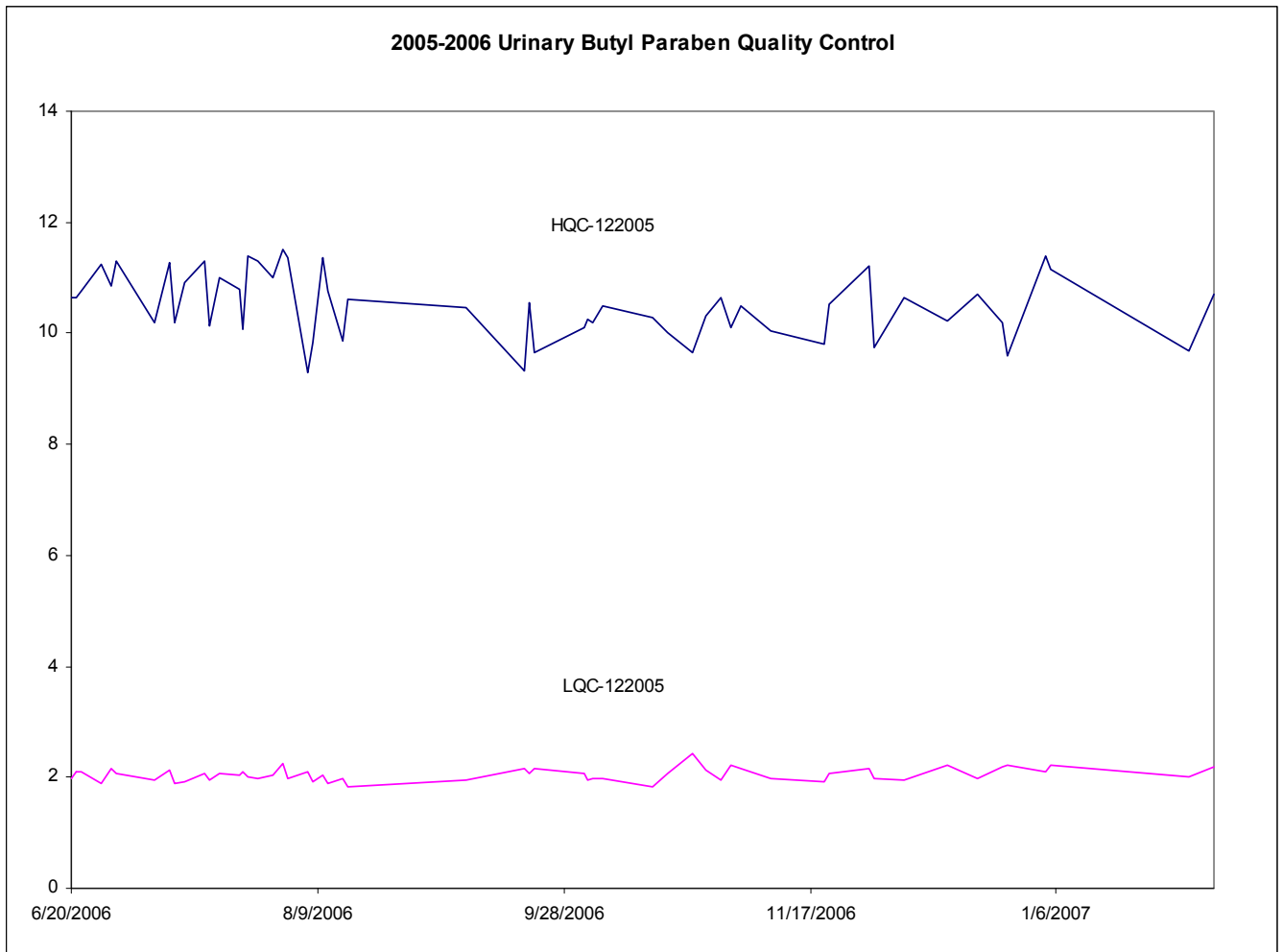

E. Ethyl paraben

Summary Statistics for Urinary Ethyl Paraben by Lot

Lot	N	Start Date	End Date	Mean	Standard Deviation	Coefficient of Variation
LQC-122005	60	6/20/2006	2/7/2007	4.759	0.577	12.1
HQC-122005	60	6/20/2006	2/7/2007	19.845	0.917	4.6

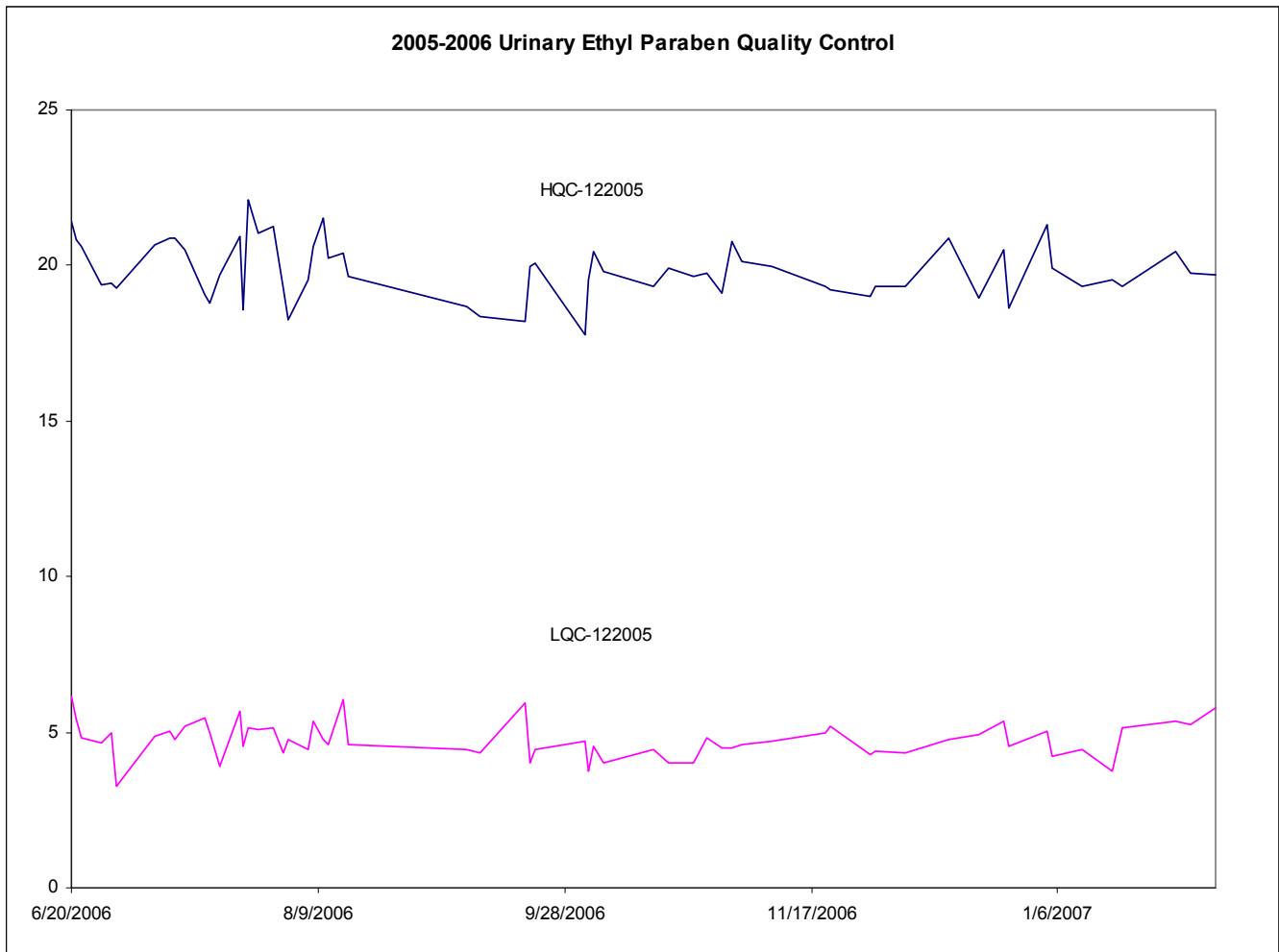

F. Methyl paraben

Summary Statistics for Urinary Methyl Paraben by Lot

Lot	N	Start Date	End Date	Mean	Standard Deviation	Coefficient of Variation
LQC-122005	66	6/20/2006	2/8/2007	8.734	0.887	10.2
HQC-122005	66	6/20/2006	2/8/2007	53.402	2.325	4.4

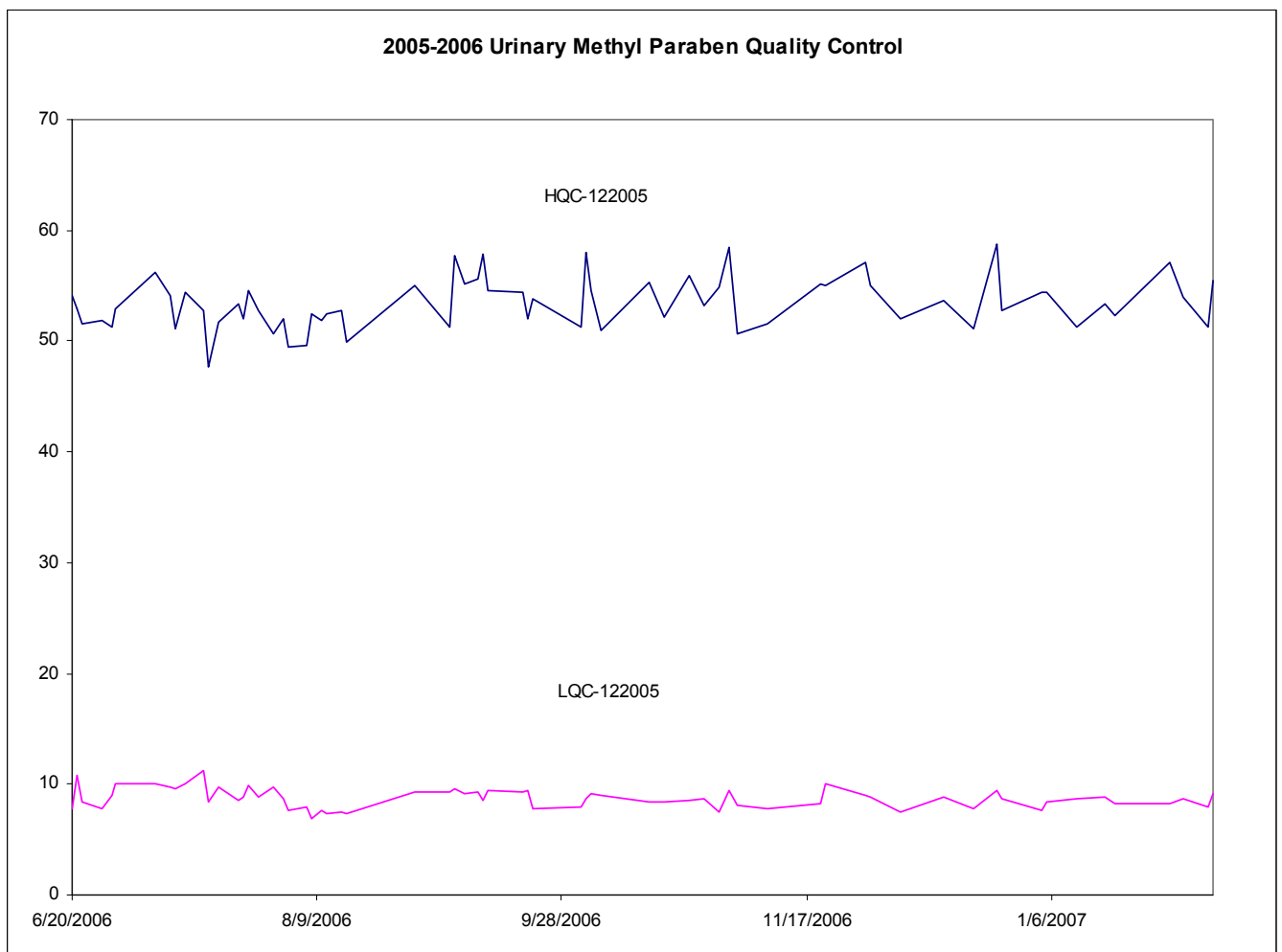

G. Propyl paraben

Summary Statistics for Urinary Propyl Paraben by Lot

Lot	N	Start Date	End Date	Mean	Standard Deviation	Coefficient of Variation
LQC-122005	66	6/20/2006	2/8/2007	6.136	0.361	5.9
HQC-122005	66	6/20/2006	2/8/2007	26.392	1.186	4.5

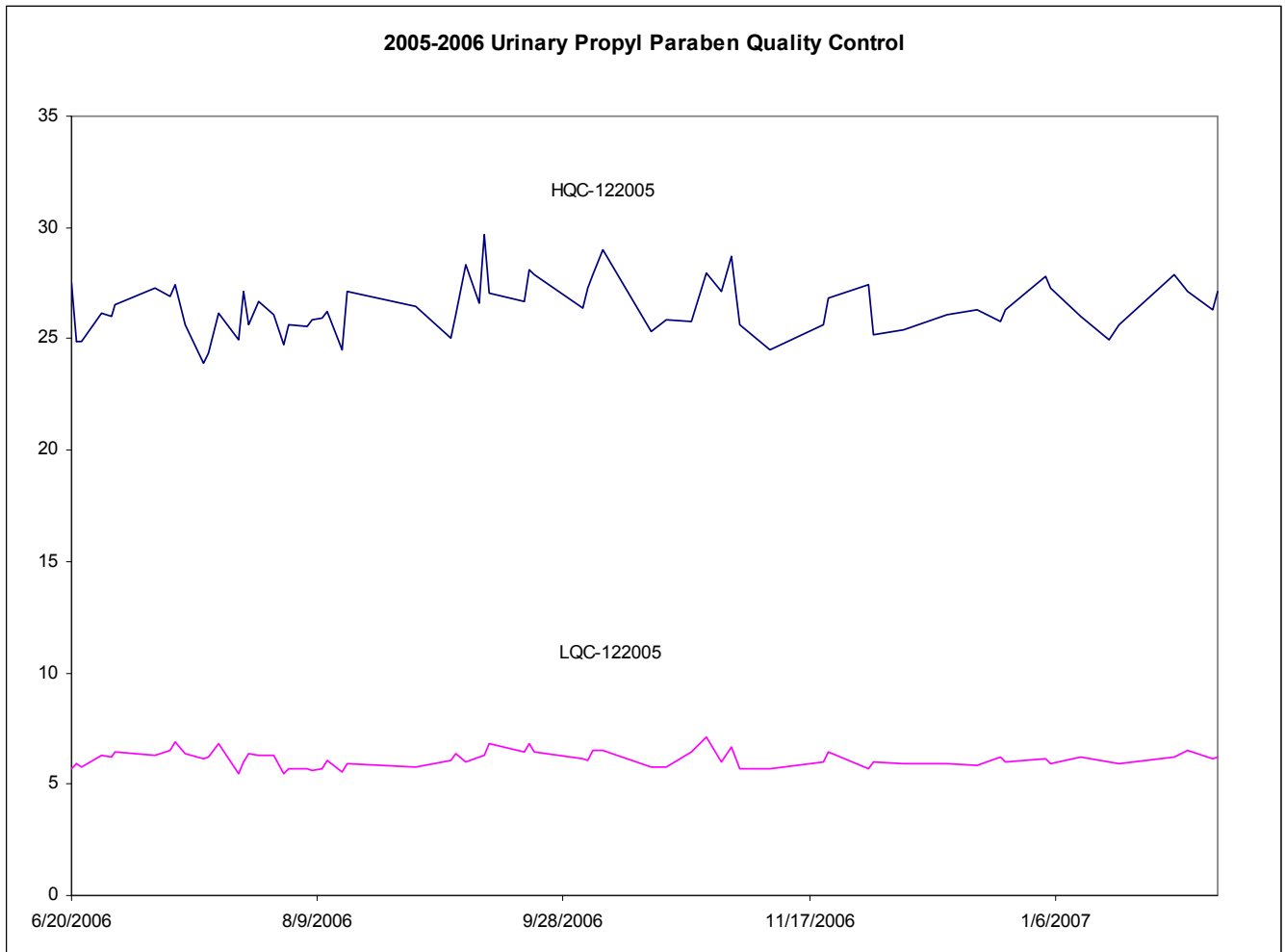

Use of trade names is for identification only and does not imply endorsement by the Public Health Service or the U.S. Department of Health and Human Services.

References

- [1] National Toxicology Program, NTP Brief on Bisphenol A [CAS NO. 80 – 05 – 07], 2008.
- [2] J. Montgomery-Brown, M. Reinhard, Environ. Engineer. Sci. 20 (2003) 471.
- [3] G.G. Ying, B. Williams, R. Kookana, Environ. Int. 28 (2002) 215.
- [4] R.L. Elder, J. Am. Coll. Toxicol. 3 (1984) 147.
- [5] E.M. Jackson, J. Toxicol. -Cutan. Ocul. Toxicol. 11 (1992) 173.
- [6] D.S. Orth, Int. J. Dermatol. 19 (1980) 504.
- [7] R.W. Weber, Ann. Allergy 70 (1993) 183.
- [8] Environmental Health Criteria Monographs (EHCs). Chlorophenols., International Programme on Chemical Safety (IPCS), 1989.
- [9] S.C. Laws, S.A. Carey, J.M. Ferrell, G.J. Bodman, R.L. Cooper, Toxicol. Sci. 54 (2000) 154.
- [10] K. Kubo, O. Arai, M. Omura, R. Watanabe, R. Ogata, S. Aou, Neurosci. Res. 45 (2003) 345.
- [11] R.J. Witorsch, Food Chem. Toxicol. 40 (2002) 905.
- [12] K.L. Howdeshell, A.K. Hotchkiss, K.A. Thayer, J.G. Vandenberg, F.S. vom Saal, Nature 401 (1999) 763.
- [13] R.E. Chapin, J. Adams, K. Boekelheide, L.E. Gray, S.W. Hayward, P.S.J. Lees, B.S. McIntyre, K.M. Portier, T.M. Schnorr, S.G. Selevan, J.G. Vandenberg, S.R. Woskie, Birth Defects Research Part B-Developmental and Reproductive Toxicology 83 (2008) 157.
- [14] European Union, EU Risk Assessment report- BPA, European Union, 2003.
- [15] J.E. Goodman, E.E. McConnell, I.G. Sipes, R.J. Witorsch, T.M. Slayton, C.J. Yu, A.S. Lewis, L.R. Rhomberg, Crit. Rev. Toxicol. 36 (2006) 387.
- [16] G.M. Gray, J.T. Cohen, G. Cunha, C. Hughes, E.E. McConnell, L. Rhomberg, I.G. Sipes, D. Mattison, Human Ecol. Risk Assessm. 10 (2004) 875.

- [17] F.S. vom Saal, C. Hughes, *Environ. Health Perspect.* 113 (2005) 926.
- [18] M. Schlumpf, B. Cotton, M. Conscience, V. Haller, B. Steinmann, W. Lichtensteiger, *Environ. Health Perspect.* 109 (2001) 239.
- [19] H. Ishibashi, N. Matsumura, M. Hirano, M. Matsuoka, H. Shiratsuchi, Y. Ishibashi, Y. Takao, K. Arizono, *Aquatic Toxicology* 67 (2004) 167.
- [20] L.Q. Wang, C.N. Falany, M.O. James, *Drug Metab Dispos.* 32 (2004) 1162.
- [21] P.D. Darbre, A. Aljarrah, W.R. Miller, N.G. Coldham, M.J. Sauer, G.S. Pope, *J. Appl. Toxicol.* 24 (2004) 5.
- [22] National Toxicology Program, Butylparaben [CAS No. 94-26-8]. Final Review of Toxicological Literature, National Toxicology Program, U.S. Department of Health and Human Services, 2004.
- [23] F. Farabollino, S. Porrini, D. Della Seta, F. Bianchi, F. Dessi-Fulgheri, *Environ. Health Perspect.* 110 (2002) 409.
- [24] R. White, S. Jobling, S.A. Hoare, J.P. Sumpter, M.G. Parker, *Endocrinology* 135 (1994) 175.
- [25] S. Jobling, T. Reynolds, R. White, M.G. Parker, J.P. Sumpter, *Environ. Health Perspect.* 103 (1995) 582.
- [26] E. Silva, N. Rajapakse, A. Kortenkamp, *Environ. Sci. Technol.* 36 (2002) 1751.
- [27] X.Y. Ye, Z. Kuklennyik, L.L. Needham, A.M. Calafat, *Anal. Chem.* 77 (2005) 5407.
- [28] X.Y. Ye, Z. Kuklennyik, A.M. Bishop, L.L. Needham, A.M. Calafat, *J Chromatogr B-Anal. Technol. Biomed. Life Sci.* 844 (2006) 53.
- [29] J.K. Taylor, *Quality Assurance of Chemical Measurements*, Lewis Publishers, Chelsea, MI, 1987.
- [30] S.P. Caudill, R.L. Schleicher, J.L. Pirkle, *Stat. Med.* 27 (2008) 4094.
- [31] CDC, Third National Report on Human Exposure to Environmental Chemicals, Centers for Disease Control and Prevention; National Center for Environmental Health; Division of Laboratory Sciences, Atlanta, GA, 2005.
- [32] A.M. Calafat, X. Ye, L.Y. Wong, J.A. Reidy, L.L. Needham, *Environ. Health Perspect.* 116 (2008) 303.
- [33] A.M. Calafat, L.-Y. Wong, X. Ye, J.A. Reidy, L.L. Needham, *Environ. Health Perspect.* 116 (2008) 893.
- [34] A.M. Calafat, X.Y. Ye, L.Y. Wong, J.A. Reidy, L.L. Needham, *Environ. Health Perspect.* 116 (2008) 39.

- [35] X.Y. Ye, A.M. Bishop, J.A. Reidy, L.L. Needham, A.M. Calafat, *Environ. Health Perspect.* 114 (2006) 1843.
- [36] X.Y. Ye, A.M. Bishop, J.A. Reidy, L.L. Needham, A.M. Calafat, *J. Expos. Sci. Environ. Epidemiol.* 17 (2007) 567.
- [37] Z. Kuklennyik, J. Ekong, C.D. Cutchins, L.L. Needham, A.M. Calafat, *Anal. Chem.* 75 (2003) 6820.