



National Health and Nutrition Examination Survey (NHANES)

MEC Laboratory Procedures Manual



January 2017

Table of Contents

<u>Chapter</u>		<u>Page</u>
1	Overview and Laboratory Team Responsibilities.....	1-1
1.1	Overview.....	1-1
1.2	The Laboratory Team.....	1-2
1.3	Tasks.....	1-2
1.4	Organization of the Laboratory.....	1-3
1.5	Tasks—Phlebotomy Room.....	1-4
1.6	Tasks—Lab Workstation 1.....	1-5
1.7	Tasks—Lab Workstation 2.....	1-5
1.8	Tasks—Lab Workstation 3.....	1-7
1.9	Cross-Training.....	1-8
2	Laboratory ISIS Functionality.....	2-1
2.1	Laboratory-Specific Functionality.....	2-1
2.2	Laboratory Heads-Up Display.....	2-1
2.3	Laboratory Task Bar.....	2-3
2.4	Menu Bar Options.....	2-3
2.4.1	File Menu Options.....	2-4
2.4.2	Utilities Menu Options.....	2-5
2.4.3	Quality Control Menu.....	2-6
2.4.4	Report Menu Options.....	2-7
2.4.5	Modules.....	2-8
2.4.6	Shipping.....	2-9
2.5	Informed Consent (IC) Exclusions.....	2-10
2.6	Set Session Utility.....	2-11
2.7	Container Map.....	2-13
2.8	Content Container Verification.....	2-15
2.9	Subsample Preview.....	2-20
2.10	Informed Consent Status.....	2-22
2.11	Access a Processing Module.....	2-24
2.12	Warning and Error Messages.....	2-24
2.12.1	Not Filled Require a Comment.....	2-5
2.12.2	Labels Must be Printed in Advance.....	2-25
2.13	Coulter and Urine Scale Icons.....	2-26

<u>Chapter</u>		<u>Page</u>
3	Venipuncture.....	3-1
	3.1 Introduction.....	3-1
	3.2 Equipment and Supplies.....	3-3
	3.3 Overview.....	3-5
	3.4 Gaining Cooperation.....	3-7
	3.4.1 Refusal Conversion.....	3-9
	3.5 Performing the Venipuncture on SPs Who Do Not Speak English.....	3-10
	3.6 Open the Exam and Log the SP into the Exam.....	3-10
	3.7 The Phlebotomy Interview.....	3-14
	3.7.1 Pregnancy Shared Exclusion Question.....	3-15
	3.7.2 Safety Exclusion Questions.....	3-18
	3.8 Administering the Fasting Questionnaire.....	3-27
	3.9 Venipuncture Procedures.....	3-36
	3.9.1 Preparation of the Puncture Site.....	3-37
	3.9.2 Venipuncture Technique for the Nipro (19-, 21-, and 23-Gauge).....	3-39
	3.9.3 Concluding the Venipuncture.....	3-40
	3.10 Pediatric Venipuncture.....	3-41
	3.10.1 Age Specific Care And Phlebotomy.....	3-43
	3.11 Hand Venipuncture.....	3-50
	3.12 Veinlite EMS.....	3-50
	3.13 Recording the Results of the Venipuncture Procedure.....	3-52
	3.14 Venipuncture Status.....	3-58
	3.15 Repeat Blood Draw.....	3-62
	3.16 Phlebotomy Quality Control.....	3-63
	3.16.1 Daily Quality Control.....	3-65
	3.17 Red Cross Procedures for Handling Fainting (Syncope).....	3-67
	3.18 How to Deal With System Failure.....	3-68

<u>Chapter</u>		<u>Page</u>
4	Urine Specimen Collection and Processing.....	4-1
	4.1 Introduction.....	4-1
	4.2 Supplies.....	4-2
	4.3 Urine Flow Rate Background.....	4-3
	4.4 Using the Scale for Urine Collection.....	4-4
	4.5 Document Urine Collection.....	4-6
	4.5.1 Quantity Not Sufficient (QNS) Urines.....	4-11
	4.6 Manually Documenting Urine Collection.....	4-22
	4.6.1 Manually Document Urine Collection With Barcode Scanning.....	4-22
	4.6.2 Manually Document Urine Collection Without Barcode Scanning.....	4-24
	4.6.3 Manually Entering Adults Who Collect in CC2.....	4-27
	4.7 Urine Specimen Assays.....	4-27
	4.8 Urine Specimen Protocols.....	4-28
	4.9 Labeling Urine Processing Vessels.....	4-29
	4.10 Urine Specimen Processing.....	4-29
	4.11 Record the Results of Urine Specimen Processing.....	4-31
	4.12 Second and Third Urine Samples.....	4-35
	4.13 Specimen Storage.....	4-36
	4.14 How to Deal With System Failure.....	4-37
5	Urine Pregnancy Test.....	5-1
	5.1 Purpose and Principle of the Test.....	5-1
	5.2 Special Safety Precautions.....	5-2
	5.3 Computerization: Integrated Survey Information System (ISIS).....	5-3
	5.4 Specimen Collection and Preparation.....	5-3
	5.5 Procedure for Microscopic Examination.....	5-4

<u>Chapter</u>		<u>Page</u>
5.6	Reagents and Supplies	5-4
	5.6.1 Reagents	5-4
	5.6.2 Supplies	5-6
5.7	Calibration.....	5-6
5.8	Assay Procedure.....	5-6
5.9	Reportable Range of Results	5-7
5.10	Quality Control (QC)	5-7
5.11	Interpretation of Results and Remedial Action.....	5-21
5.12	Record Results.....	5-23
5.13	Limitations of Method: Specimen Rejection, Interfering Substances, and Conditions.....	5-34
5.14	Reference Ranges.....	5-38
5.15	Action Limits	5-38
5.16	Specimen Storage and Handling During Testing.....	5-38
5.17	Alternative Method for Performing Test or Storing Specimens if Test System Fails	5-38
5.18	Test Results Reporting System Protocol for Reporting Action Limits	5-39
5.19	Specimen Accountability and Tracking	5-39
5.20	Quality Control Summary Statistics and Graphs	5-39
5.21	References.....	5-39
6	Complete Blood Count.....	6-1
6.1	Introduction.....	6-1
6.2	Purpose and Principle of Test.....	6-1
	6.2.1 Coulter Method.....	6-3
	6.2.2 VCSn Technology.....	6-3
	6.2.3 Dataplot Development	6-4
	6.2.4 Parameter Measurement, Derivation, and Calculation	6-5
6.3	Components of DxH 800.....	6-6
	6.3.1 The Specimen Processing Module.....	6-6
	6.3.2 The System Manager.....	6-7
	6.3.3 Pneumatic Supply Module.....	6-7

<u>Chapter</u>		<u>Page</u>
6.4	Special Safety Precautions.....	6-7
6.5	Computerization: Integrated Survey Information System (ISIS).....	6-8
6.6	Specimen Collection and Preparation.....	6-8
	6.6.1 Specimen Collection.....	6-8
	6.6.2 Specimen Preparation	6-8
6.7	Procedure for Microscopic Examination	6-9
	6.7.1 Reagents and Supplies.....	6-9
	6.7.2 DxH 800 Supplies.....	6-12
6.8	Shutdown of DxH 800 System	6-12
	6.8.1 Daily Shutdown.....	6-13
	6.8.2 Shutdown at the Mobile Examination Center.....	6-13
	6.8.3 Cancel Automatic Shutdown	6-14
	6.8.4 Manual Shutdown of DxH Units.....	6-15
6.9	Logon as User.....	6-15
	6.9.1 Entering New Operator.....	6-16
6.10	Run Daily Checks.....	6-16
	6.10.1 Daily Checks Screen.....	6-17
	6.10.2 Additional Tasks From the Daily Checks Screen	6-18
6.11	Quality Control.....	6-18
	6.11.1 Frequency of Performing Quality Control	6-19
	6.11.2 Setting Up a Control File.....	6-19
	6.11.3 Setting Up a Latron Control File.....	6-19
	6.11.4 What To Do When a Control Is Out	6-19
	6.11.5 Viewing Control Files – Data View (Menu>QA>QC)	6-21
	6.11.6 Selecting a Control.....	6-29
	6.11.7 Viewing Control Files Graphically (Menu>QA>QC>View Graph)	6-30

<u>Chapter</u>	<u>Page</u>
6.11.8 Using and Interpreting the Levey-Jennings Graphs.....	6-30
6.11.9 Add, Modify, or Delete Comments to QC Results	6-32
6.11.10 View Control Files Under Error Conditions.....	6-33
6.12 Sample Analysis.....	6-33
6.12.1 Status	6-33
6.12.2 Cassette Presentation	6-34
6.12.3 Single-Tube Presentation.....	6-34
6.12.4 Handling Alarms.....	6-35
6.13 Evaluation of Data.....	6-35
6.13.1 Flags.....	6-35
6.13.2 Codes.....	6-36
6.13.3 Messages.....	6-38
6.13.4 All Specimens	6-39
6.14 Laser Safety	6-40
6.15 Calibration of the DxH 800.....	6-41
6.15.1 Perform Calibration.....	6-41
6.15.2 Verify the Calibration of Your Instrument.....	6-41
6.15.3 Coulter Pre-Start-Up Procedure.....	6-41
6.15.4 Initial DxH 800 Startup	6-42
6.15.5 Repeatability, Carryover Check, and Calibration	6-43
6.15.6 Carryover	6-45
6.15.7 Calibration	6-46
6.16 Run Study Participants	6-47
6.16.1 Review Data and Transmit.....	6-49
6.16.2 Daily Shutdown.....	6-49
6.16.3 Prolonged Shutdown.....	6-49
6.16.4 Beginning and End of Stand Operations.....	6-49
6.16.5 Transmit All Current Stand QC data into ISIS.....	6-50
6.16.6 Print ALL 6C Cell Control and Latron Files.....	6-50
6.16.7 Export DxH 800 Data to Three (3) Discs.....	6-50

<u>Chapter</u>	<u>Page</u>
6.16.8 Perform Cleaning Procedures on the DxH 800 and Assimilate Paperwork for Shipment to Home Office	6-51
6.17 Coulter Reportable Range of Results	6-51
6.18 Integrated Survey Information System	6-52
6.18.1 Record 6C Cell and Latron® Lot Numbers in Integrated Survey Information System.....	6-52
6.18.2 Interlaboratory Quality Assurance Program (IQAP).....	6-55
6.18.3 Proficiency Testing.....	6-56
6.18.4 Linearity for WBC, RBC, Hgb, and Plt Parameters	6-58
6.19 Interpretation of Results and Remedial Action.....	6-58
6.19.1 Sample Person Hemoglobin and Hematocrit Review and Remedial Actions	6-58
6.19.2 SP Parameter Value Review and Remedial Actions	6-59
6.19.3 DxH 800 Suspect Messages	6-88
6.19.4 DXH 800 Histogram Interpretations	6-89
6.19.5 Physician Review	6-94
6.20 Limitations of Method: Specimen Rejection, Interfering Substances, and Conditions.....	6-97
6.20.1 Specimen Rejection	6-97
6.20.2 Interfering Substances and Conditions	6-98
6.21 Reference Ranges	6-100
6.22 Action Limits	6-101
6.23 Specimen Storage and Handling During Testing.....	6-102
6.24 Alternative Method for Performing Test or Storing Specimens If Test System Fails.....	6-102
6.25 Test Results Reporting System: Protocol for Reporting Action Limits	6-102
6.26 Quality Control Summary Statistics and Graphs	6-102
6.27 Troubleshooting.....	6-103

<u>Chapter</u>		<u>Page</u>
	6.28 Setting Shift Times.....	6-103
	6.29 Reference.....	6-103
7	Blood Processing.....	7-1
	7.1 Introduction.....	7-1
	7.2 Equipment and Supplies.....	7-1
	7.3 Protocols.....	7-2
	7.4 Blood Processing Age-Specific Protocols.....	7-5
	7.5 Labeling Vessels.....	7-10
	7.6 Equipment.....	7-11
	7.6.1 Benchtop Centrifuges.....	7-11
	7.6.2 Laminar Flow Biological Safety Cabinet Operating Sequence.....	7-18
	7.7 Blood-Processing Procedures.....	7-19
	7.7.1 Eppendorf Xplorer Plus Pipettes.....	7-20
	7.7.2 Process the 3-ml and 4-ml EDTA Tubes.....	7-34
	7.7.3 Process the 2-ml Gray Tube for Glucose.....	7-38
	7.7.4 Process the 3-ml, 7-ml, 10-ml, and 15-ml Red Top for Pooled Sera.....	7-39
	7.7.5 Process the 15-ml Red Top Tubes for Environmental Subsamples.....	7-41
	7.7.6 Ascorbic Acid Processing and Preparation.....	7-42
	7.7.7 Metaphosphoric Acid Preparation.....	7-43
	7.8 Record the Results of Specimen Processing.....	7-43
	7.9 Blood Specimen Storage.....	7-55
	7.9.1 Blood Specimen Storage Protocol.....	7-55
	7.10 How to Deal With System Failure.....	7-57
8	Printing Labels and Specimen Shipment.....	8-1
	8.1 Introduction.....	8-1
	8.2 Equipment and Supplies.....	8-5

<u>Chapter</u>	<u>Page</u>
8.3 Print Vessel Labels and Label Blood Processing Racks.....	8-6
8.3.1 Print Vessel Labels Using the Label Print Application	8-7
8.3.2 Main Printing Screen.....	8-8
8.3.3 Filter Options	8-9
8.3.4 Print Key	8-10
8.3.5 Print Options: Print Labels	8-11
8.3.6 Print Options: Group By.....	8-12
8.3.7 Print Options: Module Filter	8-13
8.3.8 Print Order	8-14
8.3.9 Print Display Options	8-15
8.3.10 Printing One SP's Labels.....	8-16
8.3.11 Printing Individual Labels	8-17
8.3.12 Label Action	8-18
8.3.13 Label Printing Cheat Sheet.....	8-22
8.4 Create New Container Labels	8-23
8.5 Close Containers	8-36
8.6 Trash or Reprint Container Labels.....	8-41
8.6.1 Reprint Container Labels for Existing Containers.....	8-44
8.7 Shipping Overview	8-45
8.8 Assign Containers to Shippers	8-46
8.9 Create Shipping Manifests	8-52
8.10 Informed Consent Exclusions	8-58
8.11 Packing Procedure for the Shippers.....	8-60
8.11.1 Pack Boxed Specimens	8-64
8.11.2 Pack Medium Shipping Containers for Frozen Shipment	8-64
8.11.3 Pack Small Shipping Containers for Frozen Shipment	8-65
8.11.4 Pack Medium Shipping Container for Refrigerated Shipment	8-65
8.11.5 Label Shippers.....	8-66
8.12 Container Protocol and Weekly Shipping List	8-67

<u>Chapter</u>		<u>Page</u>
9	HPV Swab Processing	9-1
	9.1 Introduction.....	9-1
	9.2 Supplies.....	9-3
	9.3 Protocol.....	9-3
	9.4 Labeling Vessels	9-4
	9.5 HPV Protocol.....	9-4
	9.6 Record Processing Results.....	9-5
	9.7 Specimen Storage.....	9-14
	9.8 Shipping Procedures.....	9-14
	9.8.1 Pack and Ship Vessel 78	9-15
	9.8.2 Label Shippers.....	9-15
	9.9 How to Deal With System Failure.....	9-15
10	Quality Control and Quality Assurance—Policies and Procedures.....	10-1
	10.1 Safety.....	10-1
	10.1.1 Introduction	10-1
	10.2 Specimen Submission and Handling.....	10-1
	10.2.1 Introduction	10-1
	10.2.2 Identification of Specimens	10-2
	10.2.3 Questions on Specimen Submission and Handling.....	10-2
	10.3 Test Requisition.....	10-2
	10.3.1 Introduction	10-2
	10.3.2 Laboratory Tests	10-3
	10.3.3 Human Subjects Review	10-3
	10.4 Test Records	10-3
	10.4.1 Introduction	10-3
	10.4.2 Components of Test Records.....	10-3

<u>Chapter</u>		<u>Page</u>
10.5	Test Report	10-4
	10.5.1 Introduction	10-4
	10.5.2 Review, Approval, and Release of Test Results	10-4
	10.5.3 List of Methods and Method Details.....	10-5
	10.5.4 Format of the Test Report	10-5
	10.5.5 Format for the Laboratory Report Cover Letter	10-6
	10.5.6 Format for Listing of Laboratory Results.....	10-6
10.6	Quality Control.....	10-6
	10.6.1 Introduction	10-6
	10.6.2 Method-Specific QC Procedures.....	10-9
	10.6.3 QC Definitions.....	10-9
	10.6.4 Overview of the Relationship Between Internal QC, Proficiency Testing, and External QC	10-10
	10.6.5 Internal (“Bench”) QC.....	10-11
	10.6.6 Coulter Interlaboratory Quality Assurance Program (IQAP)	10-12
	10.6.7 Calibration and Calibration Verification	10-16
	10.6.8 Proficiency Testing.....	10-17
	10.6.9 Calibration Verification.....	10-21
	10.6.10 Linearity	10-22
	10.6.11 Quality Control Records.....	10-23
10.7	Test Methods, Equipment, Reagents, Supplies, and Facilities	10-23
	10.7.1 Introduction	10-23
	10.7.2 Labeling of Reagents, Solutions, and Other Supplies	10-24
	10.7.3 Facilities.....	10-24
10.8	Analytical Procedure Manual.....	10-25
	10.8.1 Introduction	10-25
	10.8.2 Contents of the Analytical Procedure Documentation	10-25
	10.8.3 Approval and Record Maintenance	10-26
	10.8.4 Method Performance Specifications.....	10-26

<u>Chapter</u>		<u>Page</u>
10.9	Equipment Maintenance and Function Checks	10-27
	10.9.1 Introduction	10-27
	10.9.2 Laboratory Equipment Calibration.....	10-27
	10.9.3 Temperature Monitoring	10-27
	10.9.4 Humidity Monitoring.....	10-30
10.10	Troubleshooting.....	10-30
	10.10.1 Introduction	10-30
10.11	Integrated Survey Information System (ISIS).....	10-31
	10.11.1 Introduction	10-31
	10.11.2 Integrated Survey Information System Data Down Times.....	10-31
	10.11.3 Maintenance of LAN Hardware.....	10-31
	10.11.4 Backup Schedule of Integrated Survey Information System Data	10-32
10.12	Communications and Complaints	10-32
	10.12.1 Introduction	10-32
10.13	Quality Promotion	10-33
	10.13.1 Introduction	10-33
10.14	Quality Assurance Program.....	10-33
	10.14.1 Introduction	10-33
	10.14.2 Quality Audit: Survey Participant Test Management	10-34
	10.14.3 Quality Audit: Quality Control	10-35
	10.14.4 Quality Audit: Personnel	10-36
	10.14.5 Quality Assurance Review with Staff.....	10-36
10.15	Personnel Training and Evaluation.....	10-37

<u>Chapter</u>		<u>Page</u>
	10.16 Competency Assessment	10-37
	10.16.1 Introduction	10-37
	10.16.2 NHANES Competency Assessment Plan	10-39
11	Operational Issues	11-1
	11.1 Start of Stand Activities.....	11-1
	11.2 End of Stand Activities	11-11
	11.3 Inventory Procedures and Supplies.....	11-15
	11.3.1 General Inventory Procedures.....	11-15
	11.3.2 End of Stand Inventory Procedures	11-16
	11.3.3 Mid-Stand Inventory Procedures	11-17
	11.3.4 Start of Stand Inventory Procedures	11-18
	11.3.5 Consumables vs. Non-consumables	11-19
	11.3.6 Shipping Excess Inventory Back to the Warehouse	11-19
	11.3.7 Tracking Expired and Broken Inventory	11-19
	11.4 Dry Run.....	11-20
	11.4.1 Phlebotomy Protocol and Procedures.....	11-20
	11.4.2 Urine Processing and Pregnancy Testing.....	11-22
	11.4.3 Urine Processing.....	11-33
	11.4.4 Hematology	11-37
	11.4.5 Blood Processing and Storage	11-37
	11.4.6 Shipping Dry Run Specimens	11-39
	11.4.7 Workstation Job Aids.....	11-40
	11.5 Centrifuges Allegra X-15R—Equipment Maintenance.....	11-45
	11.6 Refrigerators and Freezers—Equipment Maintenance.....	11-48
	11.7 Use of the Temperature Recording Instrument	11-49
	11.8 Use of the Class II Type A Biological Safety Cabinet	11-51
	11.9 Ambient Air Temperature	11-65
	11.10 Humidity Monitor.....	11-65

<u>Chapter</u>	<u>Page</u>
11.11 Mettler Toledo Scale.....	11-65
11.11.1 Initial Scale Interface Setup.....	11-66
11.11.2 Scale Setup.....	11-67
11.11.3 Scale Teardown.....	11-68
11.12 Eppendorf Pipette Care, Sterilization, Maintenance, and Calibration.....	11-68
11.13 Mini Vortex Mixer Care and Storage	11-74
11.14 Laboratory Quality Control Module	11-75
11.14.1 Unusual Field Occurrence (UFO).....	11-79
11.15 Hard-Copy Supply Use Control Log	11-81
11.16 Power Loss and Laboratory Operations.....	11-83
11.16.1 Scenario 1—Power Loss During Exam Session with No Backup Generator.....	11-83
11.16.2 Scenario 2—Power Loss When the MEC Is Not Conducting Exams	11-86
11.16.3 Scenario 3—Power Loss With a Backup Generator.....	11-87

Appendixes

A	International Air Transport Association (IATA) Dangerous Goods Regulations	A-1
B	BioSafety	B-1

Tables

4-1	NHANES urine processing protocol – primary.....	4-28
4-2	Storage and shipping protocol for urine	4-37
6-1	Coulter DxH 800 analyzers serial numbers and systems IDs.....	6-1
6-2	Components on the QC Data View screen.....	6-28

<u>Tables</u>		<u>Page</u>
6-3	Coulter reportable range of results.....	6-52
6-4	CDC precision limits.....	6-67
6-5	Reference ranges (males).....	6-100
6-6	Reference ranges (females).....	6-100
7-1	Digital displays.....	7-13
7-2	Eppendorf Research Pro Electronic pipettes technical data.....	7-20
7-3	Single channel pipette technical data.....	7-22
7-4	Eppendorf pipette ordering Information.....	7-34
 <u>Figures</u>		
1-1	Laboratory layout.....	1-3
1-2	Phlebotomy room layout.....	1-4
3-1	Floor plan for phlebotomy room.....	3-3
3-2	UMF 8678 phlebotomy chair.....	3-6
5-1	ICON 25 test device.....	5-21
5-2	Positive result.....	5-21
5-3	Negative result.....	5-22
5-4	Invalid result.....	5-22
 <u>Exhibits</u>		
3-1	Venipuncture protocol — primary.....	3-49

<u>Exhibits</u>		<u>Page</u>
3-1	Venipuncture protocol — primary	3-2
3-2	Venipuncture protocol — guest.....	3-2
3-3	Alternative venipuncture protocol — primary.....	3-3
3-4	Equipment and supplies — phlebotomy	3-4
3-5	Age Specific Care and Phlebotomy by Terry Kotrla, MS, MT(ASCP)BB).....	3-43
3-6	Position of Veinlite EMS while looking for a vein.....	3-51
3-7	Position of Veinlite EMS while accessing a vein	3-52
3-8	Comment codes for Partial and Not Done venipunctures	3-60
3-9	Phlebotomy worksheet – English Primary	3-69
3-10	Phlebotomy worksheet – Spanish Primary.....	3-70
4-1	Urine collection equipment.....	4-3
4-2	Urine collection supplies – urine processing and storage.....	4-3
4-3	Comment codes for insufficient urine collection	4-19
4-4	Quality comment codes to use for filled vessels.....	4-34
4-5	Comment codes	4-35
4-6	Workstation 3 processing worksheet.....	4-38
5-1	Comparison of hCG tests	5-36
5-2	Interfering substances	5-37
6-1	Reportable parameters and analysis methods.....	6-5
6-2	Examples of trends and shifts in QC data.....	6-22

<u>Exhibits</u>		<u>Page</u>
6-3	Westgard Rule 12s	6-23
6-4	Westgard Rule 13ss.....	6-24
6-5	Westgard Rule 22s	6-25
6-6	Westgard Rule4s	6-26
6-7	Westgard Rule 41S.....	6-27
6-8	Interpretation of DxH flags	6-36
6-9	Picture of tubes	6-48
6-10	List of comments to be used.....	6-80
6-11	Cellular analysis images.....	6-89
6-12	DxH system messages.....	6-90
6-13	Red blood cell histogram examples	6-91
6-14	White blood cell histogram examples.....	6-92
6-15	Platelets histogram examples	6-93
6-16	Image of better abnormal cell detection	6-94
7-1	Nonconsumable supplies for blood processing.....	7-1
7-2	Consumable supplies for blood processing.....	7-2
7-3	Primary SP's whole blood processing protocol	7-3
7-4	Primary SP's plasma processing protocol	7-3
7-5	Primary SP's packed cells processing protocol	7-3
7-6	Primary SP's serum processing protocol.....	7-4

<u>Exhibits</u>		<u>Page</u>
7-7	Guest serum processing protocol	7-5
7-8	Blood processing protocol for primary SPs aged 1-2 years.....	7-5
7-9	Blood processing protocol for primary SPs aged 3-5 years.....	7-6
7-10	Blood processing protocol for primary SPs aged 6-11 years	7-6
7-11	Blood processing protocol for primary SPs aged 12-19 years	7-7
7-12	Blood processing protocol for primary SPs aged 20+ years.....	7-8
7-13	Blood processing protocol for guest aged 12+ years.....	7-9
7-14	Centrifuge control panel.....	7-12
7-15	Packing rotors in plastic bin (1).....	7-17
7-16	Packing rotors in plastic bin (2).....	7-18
7-17	Illustration of single channel pipette.....	7-25
7-18	Removing the lower part –for pipettes $\leq 1,000 \mu\text{l}$	7-32
7-19	Opening the lower part –for pipettes $\leq 1,000 \mu\text{l}$	7-32
7-20	Removing the lower part for the 5 ml pipette.....	7-33
7-21	Quality comment codes	7-49
7-22	Comments for not filled vessels	7-52
7-23	Storage protocol for blood.....	7-56
7-24	Workstation 2 processing worksheet.....	7-58
8-1	Blood and urine shipping protocol.....	8-2
8-2	Supplies for labels/shipping.....	8-5

<u>Exhibits</u>		<u>Page</u>
8-3	Contract laboratory addresses.....	8-61
8-4	Container protocol.....	8-67
8-5	2017 FedEx Shipping List by Laboratory Number.....	8-70
9-1	Equipment and supplies—HPV processing and storage.....	9-3
9-2	HPV processing protocol.....	9-4
9-3	Storage protocol for HPV.....	9-14
9-4	Shipping protocol.....	9-14
9-5	HPV Processing worksheet.....	9-16
10-1	Example of shifts and trends in QC data.....	10-8
10-2	Westgard Rule 12S.....	10-13
10-3	Westgard Rule 13S.....	10-13
10-4	Westgard Rule 22S.....	10-14
10-5	Westgard Rule R4S.....	10-15
10-6	Westgard Rule 41S.....	10-16
10-7	CAP hematology survey comparison criteria.....	10-21
10-8	Recommended storage conditions for reagents and tubes.....	10-28
10-9	Established ranges for monitoring instrument quality control.....	10-29
10-10	NHANES competency assessment plan.....	10-40
11-1	Equipment and supplies.....	11-15
11-2	Dry run venipuncture protocol.....	11-21

<u>Exhibits</u>		<u>Page</u>
11-3	Dry run urine processing protocol.....	11-33
11-4	Dry run processing protocol—whole blood	11-37
11-5	Dry run blood processing protocol—serum	11-38
11-6	Lubrication points	11-46
11-7	Operating the laminar flow biological safety cabinet	11-53
11-8	Explorer pipette assembly and disassembly for pipettes < 5ml	11-70
11-9	Laboratory QC table	11-75
11-10	NHANES Unusual Occurrence Log.....	11-80
11-11	NHANES Supply Use Control Log	11-82

Overview and Laboratory Team Responsibilities

1

1.1 Overview

The laboratory component of NHANES includes the collection, processing, storage, and shipping of blood, urine, and other biological and environmental specimens. Collectively, these specimens provide data about the health status of the U.S. population.

The blood collection (venipuncture) procedure consists of (1) administering a questionnaire to screen for medical conditions that will exclude the study participant (SP) from the blood draw; (2) determining fasting status; and (3) performing the blood draw. The phlebotomist also collects one additional blood tube from SPs selected for the volatile organic compounds (VOC) special study on consenting SPs aged 20 years and older.

The purpose of urine collection and processing is to collect sufficient urine from participants age 3 years and older to (1) perform a pregnancy test on selected females age 8 to 17 and all females age 18 to 59 to exclude pregnant participants from other components that could put them at risk; (2) allocate urine into vessels for storage and transport to multiple government and contract laboratories for analysis; (3) calculate a urine flow rate; and (4) allocate urine into a vessel for future studies.

The purpose of blood processing is to (1) perform a complete blood count (CBC); (2) allocate blood (whole blood, plasma, and serum) into vessels for transport to multiple government and contract laboratories for analysis; (3) allocate serum into vessels for future studies; and (4) process serum for environmental testing.

The purpose of collecting and processing a vaginal swab and a penile swab is to be able to store and transport the samples to a laboratory for HPV (human papillomavirus) analysis.

The purpose of performing a complete blood count on blood specimens is to provide a study of blood cells.

The purpose of pregnancy testing is to exclude pregnant women aged 8 to 59 years from participating in the dual-energy x-ray absorptiometry (DXA) and the Liver Ultrasound Transient

Elastography (LUTE) sections of the body composition component of the mobile equipment center (MEC) exam.

The purpose of conducting the special volatile organic compounds (VOCs) study is to collect blood to determine the prevalence of exposures to certain chemicals.

The purpose of collecting and processing an oral rinse for HPV is to be able to store and transport the samples to a laboratory for HPV (human papillomavirus) analysis. This sample is used to determine the prevalence and type of distribution of infection and to investigate the demographic and behavioral factors associated with infection.

1.2 The Laboratory Team

Each laboratory team includes three American Society of Clinical Pathologists-certified medical technologists or medical laboratory technicians who have experience in all aspects of laboratory practice and a certified phlebotomist who has experience in venipuncture.

The chief medical technologist is a senior member of the team. He or she is responsible for overseeing all the activities of the medical technologists and the phlebotomist in the MEC, as well as quality control, equipment calibration, and maintenance. On a routine basis, the chief medical technologist performs the same duties as the other laboratory staff members.

1.3 Tasks

The phlebotomist's primary tasks include conducting the venipuncture; assisting the medical technologists as needed; managing the phlebotomy component inventory; performing MEC equipment quality control (QC) activities and recording the results; printing laboratory labels; labeling blood processing racks; and assisting with the shipping process at the end of each stand. In addition, the phlebotomist acts as a backup examiner and recorder for the body measures exam and as a recorder for the oral health exam.

The medical technologists' and medical laboratory technicians' tasks include printing labels and labeling vessels; performing CBCs; conducting pregnancy tests; processing blood, urine, vaginal and

penile swabs; performing MEC equipment QC activities and recording the results; and shipping specimens to contract laboratories. On a routine basis, the medical technologists assist the phlebotomist as needed and manage the component inventory.

1.4 Organization of the Laboratory

The laboratory consists of two areas—the phlebotomy room and the laboratory (label/ship and environmental sample processing area; biological sample processing; and hematology/pregnancy testing) area. The phlebotomy room and laboratory area are located in trailer 4. Figures 1-1 and 1-2 illustrate the laboratory layout and phlebotomy room layout.

Laboratory Area Floor Plan

The laboratory area contains three workstations designated workstations 1, 2, and 3. Printing labels, labeling vials for each SP's blood-processing rack, and shipping activities occur at workstation 1. Blood processing and storage occur at workstation 2. Urine collection; urine processing and storage; pregnancy testing; running CBCs; vaginal and penile swab specimen processing; and routine quality control activities occur at workstation 3.

Figure 1-1. Laboratory layout

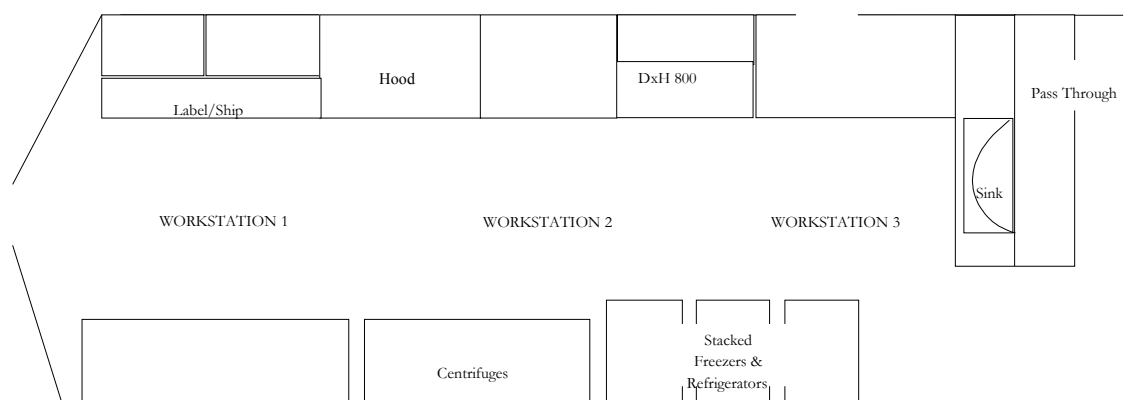

In the three workstations, the laboratory staff processes, stores, and ships biological and environmental samples; analyzes blood for a complete blood count; and performs pregnancy testing. The staff also prints labels, labels blood processing racks, and prepares shipping documents.

Figure 1-2. Phlebotomy room layout



The phlebotomist performs the phlebotomy examination in the phlebotomy room.

1.5 Tasks—Phlebotomy Room

- Set up supplies and check expiration dates of all items with lot numbers, such as the Vacutainer[®] tubes;
- Complete the phlebotomy examination, including conducting the venipuncture interview, administering the fasting questionnaire, and performing the venipuncture;
- Label and transfer all blood tubes to the laboratory area;
- Disinfect all the counters and blood draw chair at the end of each session, or as needed when soiled with blood or other body fluids;
- Take and record the QC readings;
- Maintain the appearance of the venipuncture area and the equipment;
- Monitor the inventory and restock supplies;
- Conduct the start and end of stand inventory counts;
- Clean and stock the phlebotomy room, including the equipment, at the start and end of each stand;
- Assist in printing laboratory labels, and label and assemble blood-processing racks;
- Assist the lab staff when they pack the shippers; and
- Serve as the backup examiner and recorder in body measures and recorder in oral health.

1.6 Tasks—Lab Workstation 1

- Complete blood processing tasks for the first 45 minutes of each session;
- Print blood, urine, and pregnancy testing labels;
- Prelabel the vials for each SP's blood-processing rack;
- Generate container IDs at the start of stand;
- Assign a container ID label to one container for each vessel;
- When shipping, close all open containers, create airbills, and assign containers to shippers;
- Print shipping manifests;
- Prepare blood (whole blood, serum, and plasma), urine, vaginal, and penile swab samples for shipping;
- Pack, label, and ship shippers;
- Open all new containers after shipping;
- Prepare Class 9 labels for next stand;
- Prepare return shipping packets at the start of the stand;
- Maintain appearance of the label/ship area and the equipment;
- Monitor inventory and restock supplies;
- Assist phlebotomist with venipuncture;
- Conduct start and end of stand inventory counts;
- Clean the laboratory at the start and end of each stand; and
- Disinfect counters and work area at the end of each day.

1.7 Tasks—Lab Workstation 2

- Stock blood processing and storage supplies;
- Receive blood specimens;
- Select the correct prelabeled rack and age-appropriate template;

- Set the red -top blood tubes aside to clot;
- Pipette whole blood into separate 2-ml cryovials from the 3-ml or 4-ml lavender tube for vessel 1 (lead/cad/Hg), vessel 216 (Cr/Co), vessel 3 (RBC folate), vessel 4 (glycohem), and vessel 5 (mercury);
- Pipette the plasma from the 3-ml or 4-ml lavender tube and perform cell washing on the remaining cells for vessel 88 (acrylamide).
- Make the dilution for RBC folate vessels and serum folate vessels;
- Make the dilution for the Vitamin C vessel;
- Transfer the 3-ml or 4-ml lavender tube to the workstation 3 technologists for hematology if needed;
- Centrifuge the 2-ml gray tube;
- Pipette the plasma from the 2-ml gray tube into a 2-ml cryovial for vessel 9 (glucose);
- Centrifuge the red-top tubes;
- Pool the serum from the 3-ml, 7-ml, 10-ml, and 15-ml red-top tubes for each SP and mix well;
- Aliquot serum into separate 2-ml cryovials for the serum vessels according to the age-specific protocols;
- Pool serum from two 15-ml red-top tubes into a 14 ml Falcon tube and aliquot 1.5-ml into vessel 90 and the remaining serum into vessels 29 and 89. Aliquot equal volumes of serum from a separate 15-ml red-top tube into vessels 92 and 93;
- Enter all blood processing results;
- Enter the blood processing results;
- Refrigerate or freeze the processed vessels;
- Check contents of blood storage boxes (containers) using the content container verification module at the end of each session;
- Disinfect all the counters and the laminar flow hood at the beginning and end of each session or when the area becomes soiled with blood or other body fluids;
- Maintain appearance of the blood processing area and the equipment;
- Monitor the inventory and restock supplies;
- Conduct the start and end of stand inventory counts;

- Clean the laboratory at the start and end of each stand; and
- Assist in printing laboratory labels and label and assemble blood-processing racks.

1.8 Tasks—Lab Workstation 3

- Perform start of stand, start of session, end of session, weekly, and end of stand quality control checks on laboratory equipment and record results;
- Prepare the 1% and 7% ascorbic acid solutions daily;
- Prepare the 6% MPA solution daily;
- Enter the ascorbic preparation into Daily QC;
- Stock supplies for urine processing, hematology, and pregnancy;
- Verify and accept the urine volume and record the urine collection results;
- Run the pregnancy test controls;
- Perform startup procedures and run quality control materials on the Coulter[®] DxH 800;
- Run specimens on the Coulter[®] DxH 800 and enter results;
- Process and refrigerate VOC blood (vessel 54) tube;
- Conduct the pregnancy test and enter results;
- Label urine vessels and aliquot into 2- or 5-ml cryovials, 14-ml Falcon snap cap, or 10-ml VWR screwcap tubes according to the processing protocol;
- Enter the urine processing results;
- Store the urine vessels;
- Process vaginal swab (vessel 78);
- Process penile swab (vessel 140);
- Check contents of urine, vaginal swab, penile swab, and oral rinse boxes and bags using the content container verification module at the end of each session;
- Disinfect all work areas at the beginning of the stand and end of each session, or when they become soiled with blood or other body fluids;
- Maintain the appearance of the urine processing/hematology area and the equipment;

- Monitor the inventory and restock supplies;
- Conduct the start and end of stand inventory counts;
- Clean the laboratory at the start and end of each stand; and
- Assist in printing laboratory labels and label and assemble blood-processing racks.

1.9 Cross-Training

Cross-training the medical technologists and the phlebotomist increases an individual's skills and provides scheduling flexibility and a safety net during staff absences. The primary phlebotomist helps the lab team set up and tear down. Medical technologists and technicians trained in phlebotomy (backup phlebotomists) work in phlebotomy on a routine basis to ensure competency and proficiency. The basic underlying assumption is that the blood draw must **never** be compromised. The primary phlebotomists must be available to step in and complete the blood draw even when backups are working in phlebotomy.

- When the backup phlebotomist is assigned to workstation 1 (label/ship):
 - The primary phlebotomist works at workstation 1, except on Monday when the lab team ships. The backup phlebotomist always works the scheduled workstation 1 assignment on shipping Mondays.
 - The backup phlebotomist works in phlebotomy when the primary phlebotomist works at workstation 1.
- The primary phlebotomist, if available, should perform the pediatric blood draws while the backup phlebotomist observes and holds the child.
- If the backup phlebotomist encounters a difficult blood draw, then the primary phlebotomist comes into the room and they work together so that the blood draw is successful. This is intended as a learning experience; the backup phlebotomist can continue to learn from the primary phlebotomist.
- There are no rules for how many days the backup phlebotomist works in phlebotomy during each stand. The objective is at least 2-3 days per stand with emphasis on sessions with 8-10 adult SPs.
- On setup day, the phlebotomist completes his or her room setup and assigned tasks before helping lab staff. On setup day, the phlebotomist should, at a minimum, make the racks for dry run day. On teardown day, he or she helps pack the shippers and assists the lab staff in other ways as directed by the chief medical technologist.

2.1 Laboratory-Specific Functionality

While mobile examination center (MEC) applications are custom built for each specific component, they share a common design. This commonality provides all component applications the same “look and feel,” which minimizes reorienting staff who rotate from component to component. A complete ISIS overview and these features and characteristics are described in the *Integrated Survey Information System (ISIS) User Guide*. The laboratory application has additional functionality that has been developed to accommodate and facilitate processing specimens and reporting results, as described in this chapter.

2.2 Laboratory Heads-Up Display

The laboratory heads-up display presents the sample persons (SPs) scheduled into the session, the modules for which they are eligible, and their current process status. Use the heads-up display to access modules.

SP ID	Sample ID	Status	Type	Gender	Age	Name	Process Status			HPV			
							UC	U	P	CB	B	PC	F
329869	329869	SC	P	F	12	HOWARD, CHARLES S	<input type="radio"/>	<input type="radio"/>	<input type="radio"/>	<input type="radio"/>	<input type="radio"/>	<input type="radio"/>	<input type="radio"/>
386827	386827	SC	P	F	26	DEEGAN, DOUG O	<input type="radio"/>	<input type="radio"/>	<input type="radio"/>	<input type="radio"/>	<input type="radio"/>	<input type="radio"/>	<input type="radio"/>
416714	416714	SC	P	F	16	BAILEY, ANTHONY J	<input type="radio"/>	<input type="radio"/>	<input type="radio"/>	<input type="radio"/>	<input type="radio"/>	<input type="radio"/>	<input type="radio"/>
499508	499508	SC	P	F	5	DEEGAN, MARK	<input type="radio"/>	<input type="radio"/>	<input type="radio"/>	<input type="radio"/>	<input type="radio"/>	<input type="radio"/>	<input type="radio"/>
525757	525757	SC	P	M	3	LAST NAME, PAT M	<input type="radio"/>	<input type="radio"/>	<input type="radio"/>	<input type="radio"/>	<input type="radio"/>	<input type="radio"/>	<input type="radio"/>
745052	745052	SC	P	F	12	TIM, SP FIRST NAME M	<input type="radio"/>	<input type="radio"/>	<input type="radio"/>	<input type="radio"/>	<input type="radio"/>	<input type="radio"/>	<input type="radio"/>
767995	767995	SC	P	F	39	NAME, LAST M	<input type="radio"/>	<input type="radio"/>	<input type="radio"/>	<input type="radio"/>	<input type="radio"/>	<input type="radio"/>	<input type="radio"/>
836040	836040	SC	P	M	54	TORRES, LUCAS T	<input type="radio"/>	<input type="radio"/>	<input type="radio"/>	<input type="radio"/>	<input type="radio"/>	<input type="radio"/>	<input type="radio"/>
849425	849425	SC	P	F	16	CAMPBELL, VINNIE N	<input type="radio"/>	<input type="radio"/>	<input type="radio"/>	<input type="radio"/>	<input type="radio"/>	<input type="radio"/>	<input type="radio"/>
919919	919919	SC	P	M	57	PAYNE, IMA L	<input type="radio"/>	<input type="radio"/>	<input type="radio"/>	<input type="radio"/>	<input type="radio"/>	<input type="radio"/>	<input type="radio"/>

The heads-up display lists all SPs with appointments for the current session. It includes the SP ID, Sample ID, Status (SC=scheduled, LI=Logged-in, CI=checked-in, BE=being examined, EX=exited), Appointment Type (P=primary, G=guest, VIP=VIP guest, D=dry run), Gender (M=male, F=female), Age, and Name (last, first.)

The heads-up display provides the Process Status for the following modules: UC (urine collection), U (urine processing), P (pregnancy testing), CBC (complete blood count), B (blood processing), PC (Packed Cell or vessel 88 processing), and HPV (HPV swab processing; F for female and M for Male). The SP is ineligible for a module when the process status is ○. The SP is eligible for a module, but no results have been recorded when the process status is ○. The SP is eligible for a module, and some results have been recorded when the process status is ⊙. The SP is eligible for a module, all results have been recorded, and the module is complete when the process status is ●.

The SP is eligible for a module (○), but the process status for blood processing (B) and the CBC will not enable until at least one blood tube has been recorded as collected in the phlebotomy component. Only SPs who have checked in are eligible for HPV processing. The process status is ○ for urine processing (U), and pregnancy testing (P), until the SP's urine is marked as collected in the UC module. Once these samples are collected, the process status changes from ○ to ○. The process status regularly updates and changes after each result is saved.

The active SP is contained in a rectangular box. Use the heads-up display to select the correct SP. Select a different SP if the active SP is not the SP of choice.

2.3 Laboratory Task Bar

Monitor the activity in the laboratory task bar, which is located on the bottom of the screen.

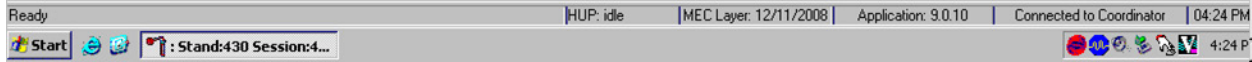

The laboratory task bar displays the following information:

- The status of the refresh routine such as when the labels are printing or the data are updating;
- The status of the heads-up display such as when it is “idle”;
- The current version of the MEC layout;
- The current version of the application;
- The status of the connection to the coordinator; and
- The current time.

2.4 Menu Bar Options

Each MEC application has tailored menu options to support the specific examination. The menu options below list all available options. The options marked with an asterisk appear on all MEC examination programs. Options are grayed (inverted) or not present when they are not available for a specific subsystem.

2.4.1 File Menu Options

The screenshot shows the 'Lab Sink' application window. The 'File' menu is open, displaying options: Open (Ctrl+O), Close, Print..., Delete, and Exit. The main window displays a table with columns: ID, Status, Type, Gender, Age, Name, Process Status (UC, U, P, CB, B, PC), and HPV (F, M). The table contains several rows of patient data.

ID	Status	Type	Gender	Age	Name	Process Status							
						UC	U	P	CB	B	PC	F	M
69	SC	P	F	12	HOWARD, CHARLES S	<input type="radio"/>	<input type="radio"/>	<input type="radio"/>	<input type="radio"/>	<input type="radio"/>	<input type="radio"/>	-	-
27	SC	P	F	26	DEEGAN, DOUG O	<input type="radio"/>	<input type="radio"/>	<input type="radio"/>	<input type="radio"/>	<input type="radio"/>	-	<input type="radio"/>	-
416714	416714	SC	P	16	BAILEY, ANTHONY J	<input type="radio"/>	<input type="radio"/>	<input type="radio"/>	<input type="radio"/>	<input type="radio"/>	<input type="radio"/>	<input type="radio"/>	-
499508	499508	SC	P	5	DEEGAN, MARK	<input type="radio"/>	<input type="radio"/>	-	<input type="radio"/>	<input type="radio"/>	-	-	-
525757	525757	SC	P	3	LAST NAME, PAT M	<input type="radio"/>	<input type="radio"/>	-	<input type="radio"/>	<input type="radio"/>	-	-	-
745052	745052	SC	P	12	TIM, SP FIRST NAME M	<input type="radio"/>	<input type="radio"/>	<input type="radio"/>	<input type="radio"/>	<input type="radio"/>	-	-	-
767995	767995	SC	P	39	NAME, LAST M	<input type="radio"/>	<input type="radio"/>	<input type="radio"/>	<input type="radio"/>	<input type="radio"/>	-	<input type="radio"/>	-
836040	836040	SC	P	54	TORRES, LUCAS T	<input type="radio"/>	<input type="radio"/>	-	<input type="radio"/>	<input type="radio"/>	-	-	<input type="radio"/>
849425	849425	SC	P	16	CAMPBELL, VINNIE N	<input type="radio"/>	<input type="radio"/>	<input type="radio"/>	<input type="radio"/>	<input type="radio"/>	<input type="radio"/>	<input type="radio"/>	-
919919	919919	SC	P	57	PAYNE, IMA L	<input type="radio"/>	<input type="radio"/>	-	<input type="radio"/>	<input type="radio"/>	<input type="radio"/>	-	<input type="radio"/>

Asterisks (*) denote menu options common to all MEC examination components.

*File	
*Open (Ctrl+O)	Opens a new, partial, or not done SP exam; the SP must be assigned by the coordinator if the application is not in standalone mode.
*Close	This option is grayed out and not applicable.
*Print	Prints the current examination screen or report.
*Delete	This option is grayed out and not applicable.
*Exit	Exits the application.

2.4.2 Utilities Menu Options

The screenshot shows the 'Lab Sink' application window. The 'Utilities' menu is open, displaying options: Exam Pause, Observations, IC Exclusions, Send Message (Ctrl+M), UFO Sighting, Set Session, English (Ctrl+E), Spanish (Ctrl+S), Toolbars..., and System Configuration. The background table lists patient information with columns for SP ID, Gender, Age, Name, Process Status (UC, U, P, CB, B, PC), and HPV (F, M).

SP ID	Gender	Age	Name	UC	U	P	CB	B	PC	F	M
329869	F	12	HOWARD, CHARLES S	<input type="radio"/>	<input type="radio"/>	<input type="radio"/>	<input type="radio"/>	<input type="radio"/>	<input type="radio"/>	-	-
386827	F	26	DEEGAN, DOUG O	<input type="radio"/>	<input type="radio"/>	<input type="radio"/>	<input type="radio"/>	<input type="radio"/>	-	<input type="radio"/>	-
416714	F	16	BAILEY, ANTHONY J	<input type="radio"/>	<input type="radio"/>	<input type="radio"/>	<input type="radio"/>	<input type="radio"/>	<input type="radio"/>	<input type="radio"/>	-
499508	F	5	DEEGAN, MARK	<input type="radio"/>	<input type="radio"/>	-	<input type="radio"/>	<input type="radio"/>	-	-	-
525757	M	3	LAST NAME, PAT M	<input type="radio"/>	<input type="radio"/>	-	<input type="radio"/>	<input type="radio"/>	-	-	-
745052	F	12	TIM, SP FIRST NAME M	<input type="radio"/>	<input type="radio"/>	<input type="radio"/>	<input type="radio"/>	<input type="radio"/>	-	-	-
767995	F	39	NAME, LAST M	<input type="radio"/>	<input type="radio"/>	<input type="radio"/>	<input type="radio"/>	<input type="radio"/>	-	<input type="radio"/>	-
836040	M	54	TORRES, LUCAS T	<input type="radio"/>	<input type="radio"/>	-	<input type="radio"/>	<input type="radio"/>	-	-	<input type="radio"/>
849425	F	16	CAMPBELL, VINNIE N	<input type="radio"/>	<input type="radio"/>	<input type="radio"/>	<input type="radio"/>	<input type="radio"/>	<input type="radio"/>	<input type="radio"/>	-
919919	M	57	PAYNE, IMA L	<input type="radio"/>	<input type="radio"/>	-	<input type="radio"/>	<input type="radio"/>	<input type="radio"/>	-	<input type="radio"/>

*Utilities	
*Exam Pause	This option is grayed out and not applicable.
*Observation	Submits an observation to the physician for possible referral.
IC Exclusions	This option is grayed out in the Laboratory application and is not applicable. Posts an exclusion record for those SPs who do not want HIV, STD, or HPV tests performed, or samples stored for future research; this utility is available only for coordinator, physician, and phlebotomy. A complete description of this functionality is described in Section 2.5.
*Send Message (Ctrl+M)	Opens a dialog box to send messages to the coordinator.
*UFO Sighting	Opens the Unusual Field Occurrence utility to document unusual equipment, SP, protocol, trailer, or supply issues.
Set Session	Allows the laboratory medical technologist to change the current session in the laboratory application. A complete description of this functionality is described in Section 2.6.
English (Ctrl+E)	This option is grayed out in the Laboratory application and is not applicable. Toggle option to set exam language to English.
Spanish (Ctrl+S)	This option is grayed out in the Laboratory application and is not applicable. Toggle option to set exam language to Spanish.
*Toolbars	Configures placement of toolbars.
*System Configuration	Displays the configuration and version of Lab Application.

2.4.3 Quality Control Menu

The screenshot shows the Lab Sink software interface. The menu bar includes File, View, Utilities, Quality Control, Reports, Modules, Shipping, Window, and Help. The Quality Control menu is open, showing options for Quality Control (Ctrl+Q) and Pregnancy QC. Below the menu is a data table with the following columns: SP ID, Sample ID, Status, type, Gender, Age, Name, Process Status (UC, U, P, CB, B, PC), and HPV (F, M). The table contains 10 rows of patient data.

SP ID	Sample ID	Status	type	Gender	Age	Name	Process Status							
							UC	U	P	CB	B	PC	F	M
329869	329869	SC	P	F	12	HOWARD, CHARLES S	<input type="radio"/>	<input type="radio"/>	<input type="radio"/>	<input type="radio"/>	<input type="radio"/>	<input type="radio"/>	-	-
386827	386827	SC	P	F	26	DEEGAN, DOUG O	<input type="radio"/>	<input type="radio"/>	<input type="radio"/>	<input type="radio"/>	<input type="radio"/>	-	<input type="radio"/>	-
416714	416714	SC	P	F	16	BAILEY, ANTHONY J	<input type="radio"/>	<input type="radio"/>	<input type="radio"/>	<input type="radio"/>	<input type="radio"/>	<input type="radio"/>	<input type="radio"/>	-
499508	499508	SC	P	F	5	DEEGAN, MARK	<input type="radio"/>	<input type="radio"/>	-	<input type="radio"/>	<input type="radio"/>	-	-	-
525757	525757	SC	P	M	3	LAST NAME, PAT M	<input type="radio"/>	<input type="radio"/>	-	<input type="radio"/>	<input type="radio"/>	-	-	-
745052	745052	SC	P	F	12	TIM, SP FIRST NAME M	<input type="radio"/>	<input type="radio"/>	<input type="radio"/>	<input type="radio"/>	<input type="radio"/>	-	-	-
767995	767995	SC	P	F	39	NAME, LAST M	<input type="radio"/>	<input type="radio"/>	<input type="radio"/>	<input type="radio"/>	<input type="radio"/>	-	<input type="radio"/>	-
836040	836040	SC	P	M	54	TORRES, LUCAS T	<input type="radio"/>	<input type="radio"/>	-	<input type="radio"/>	<input type="radio"/>	-	-	<input type="radio"/>
849425	849425	SC	P	F	16	CAMPBELL, VINNIE N	<input type="radio"/>	<input type="radio"/>	<input type="radio"/>	<input type="radio"/>	<input type="radio"/>	<input type="radio"/>	<input type="radio"/>	-
919919	919919	SC	P	M	57	PAYNE, IMA L	<input type="radio"/>	<input type="radio"/>	-	<input type="radio"/>	<input type="radio"/>	<input type="radio"/>	-	<input type="radio"/>

*Quality Control	
Quality Control	Opens Quality Control for Start of Stand, End of Stand, Daily, Weekly, and NCHS QC.
Pregnancy QC	Opens pregnancy quality control window.

2.4.4 Report Menu Options

SP ID	Sample ID	Status				Name	Process Status						HPV	
			P	F	Age	UC	U	P	CB	B	PC	F	M	
329869	329869	SC												
386827	386827	SC												
416714	416714	SC	P	F	16									
499508	499508	SC	P	F	5									
525757	525757	SC	P	M	3									
745052	745052	SC	P	F	12									
767995	767995	SC	P	F	39									
836040	836040	SC	P	M	54									
849425	849425	SC	P	F	16									
919919	919919	SC	P	M	57									

*Reports	
Show Results	This option is grayed out and not applicable.
*Room Log	Lists the SPs who have completed the component, including appt/exam and component status.
Session Preview	Lists all SPs in current session.
Subsample Preview	List the SPs who are eligible for the various subsamples. A complete description of this functionality is described in Section 2.9.
Partial SP Session	Lists the original session for which the partial SP was scheduled.
Informed Consent Status	Lists the various modules that require consent and displays the result of the consent – excluded or not excluded. A complete description of this functionality is described in Section 2.10.

2.4.5 Modules

SP ID	Sample ID	Status	Type	Gender	Age	Name	Process Status						HPV	
							UC	U	P	CB	B	PC	F	M
329869	329869	SC	P	F	12	HOWARD, CHARLES S	<input type="radio"/>	<input type="radio"/>	<input type="radio"/>	<input type="radio"/>	<input type="radio"/>	<input type="radio"/>	-	-
386827	386827	SC	P	F	26	DEEGAN, DOUG O	<input type="radio"/>	<input type="radio"/>	<input type="radio"/>	<input type="radio"/>	<input type="radio"/>	<input type="radio"/>	<input type="radio"/>	-
416714	416714	SC	P	F	16	BAILEY, ANTHONY J	<input type="radio"/>	<input type="radio"/>	<input type="radio"/>	<input type="radio"/>	<input type="radio"/>	<input type="radio"/>	<input type="radio"/>	-
499508	499508	SC	P	F	5	DEEGAN, MARK	<input type="radio"/>	<input type="radio"/>	<input type="radio"/>	<input type="radio"/>	<input type="radio"/>	<input type="radio"/>	-	-
525757	525757	SC	P	M	3	LAST NAME, PAT M	<input type="radio"/>	<input type="radio"/>	<input type="radio"/>	<input type="radio"/>	<input type="radio"/>	<input type="radio"/>	-	-
745052	745052	SC	P	F	12	TIM, SP FIRST NAME M	<input type="radio"/>	<input type="radio"/>	<input type="radio"/>	<input type="radio"/>	<input type="radio"/>	<input type="radio"/>	-	-
767995	767995	SC	P	F	39	NAME, LAST M	<input type="radio"/>	<input type="radio"/>	<input type="radio"/>	<input type="radio"/>	<input type="radio"/>	<input type="radio"/>	<input type="radio"/>	-
836040	836040	SC	P	M	54	TORRES, LUCAS T	<input type="radio"/>	<input type="radio"/>	<input type="radio"/>	<input type="radio"/>	<input type="radio"/>	<input type="radio"/>	-	<input type="radio"/>
849425	849425	SC	P	F	16	CAMPBELL, VINNIE N	<input type="radio"/>	<input type="radio"/>	<input type="radio"/>	<input type="radio"/>	<input type="radio"/>	<input type="radio"/>	<input type="radio"/>	-
919919	919919	SC	P	M	57	PAYNE, IMA L	<input type="radio"/>	<input type="radio"/>	<input type="radio"/>	<input type="radio"/>	<input type="radio"/>	<input type="radio"/>	-	<input type="radio"/>

Modules	
Hematology	Opens the laboratory hematology module. A complete description of this functionality is described in Section 6.19.2.

2.4.6 Shipping

SP ID	Sample ID	Status	Type	Gender	A	Process Status							
						UC	U	P	CB	B	PC	F	M
329869	329869	SC	P	F		<input type="radio"/>	<input type="radio"/>	<input type="radio"/>	<input type="radio"/>	<input type="radio"/>	<input type="radio"/>	-	-
386827	386827	SC	P	F		<input type="radio"/>	<input type="radio"/>	<input type="radio"/>	<input type="radio"/>	<input type="radio"/>	-	<input type="radio"/>	-
416714	416714	SC	P	F	TO BAILEY, ANTHONY J	<input type="radio"/>	<input type="radio"/>	<input type="radio"/>	<input type="radio"/>	<input type="radio"/>	<input type="radio"/>	<input type="radio"/>	-
499508	499508	SC	P	F	5 DEEGAN, MARK	<input type="radio"/>	<input type="radio"/>	-	<input type="radio"/>	<input type="radio"/>	-	-	-
525757	525757	SC	P	M	3 LAST NAME, PAT M	<input type="radio"/>	<input type="radio"/>	-	<input type="radio"/>	<input type="radio"/>	-	-	-
745052	745052	SC	P	F	12 TIM, SP FIRST NAME M	<input type="radio"/>	<input type="radio"/>	<input type="radio"/>	<input type="radio"/>	<input type="radio"/>	-	-	-
767995	767995	SC	P	F	39 NAME, LAST M	<input type="radio"/>	<input type="radio"/>	<input type="radio"/>	<input type="radio"/>	<input type="radio"/>	-	<input type="radio"/>	-
836040	836040	SC	P	M	54 TORRES, LUCAS T	<input type="radio"/>	<input type="radio"/>	-	<input type="radio"/>	<input type="radio"/>	-	-	<input type="radio"/>
849425	849425	SC	P	F	16 CAMPBELL, VINNIE N	<input type="radio"/>	<input type="radio"/>	<input type="radio"/>	<input type="radio"/>	<input type="radio"/>	<input type="radio"/>	<input type="radio"/>	-
919919	919919	SC	P	M	57 PAYNE, IMA L	<input type="radio"/>	<input type="radio"/>	-	<input type="radio"/>	<input type="radio"/>	<input type="radio"/>	-	<input type="radio"/>

Shipping	
Print New Container Labels	Allows the medical technologist to print labels for containers. A complete description of this functionality is in Section 8.4.
Container Map	Allows the medical technologist to view a list of all containers with a graphic representation of the samples assigned to that container. A complete description of this functionality is in Section 2.7. To reprint container labels, see section 8.5.1.
Close Containers	Allows the medical technologist to “close” active containers that have been previously opened. A complete description of this functionality is in Section 85.
Assign Containers to Shippers	Allows the medical technologist to assign or associate a closed container with a FedEx airbill number. A complete description of this functionality is in Section 8.8.
Trash Containers	Allows the medical technologist to delete container label numbers in the database for labels that are damaged. A complete description of this functionality is in Section 8.6.
Shipping Manifest	Allows the medical technologist to print hard-copy manifests and electronically send email files to the contract laboratories. A complete description of this functionality is in Section 8.9.
Container Content Verification	Allows the medical technologist to view a list of containers with a graphic representation of that container. The tech uses the bar code gun to scan in the contents of that container to verify that the specimen is in the correct position. See page 2-15 for a complete description.

2.5 Informed Consent (IC) Exclusions

If at any time during the phlebotomy or physician exam, the SP indicates that he or she does not want his or her biological specimens tested for HIV (AIDS), STD (sexually transmitted diseases include chlamydia, trichomonas, and *Mycoplasma genitalium*), HPV, or future studies, then the staff enter this information using the IC Exclusions module.

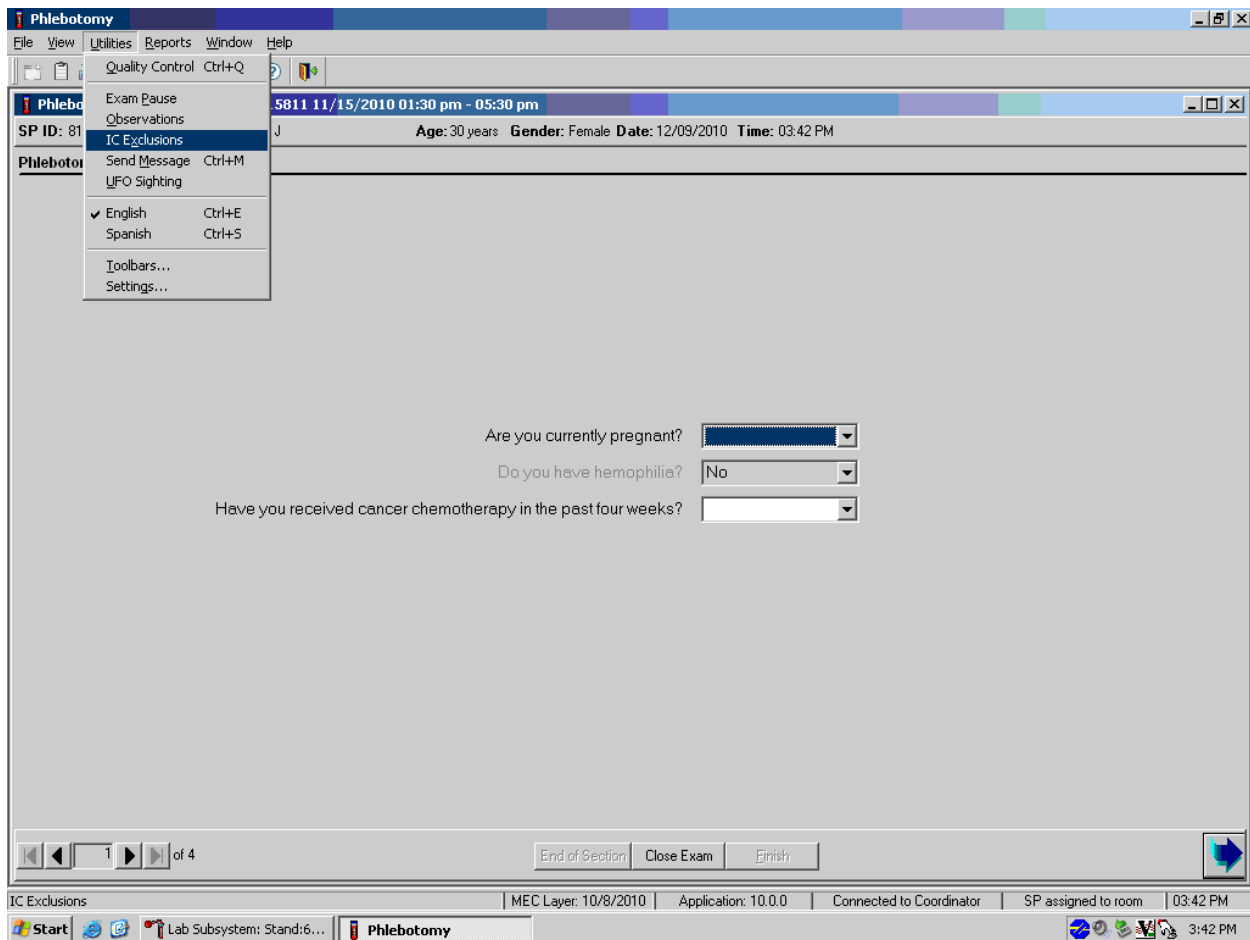

To access the IC (informed consent) Exclusions module, direct the mouse arrow to Utilities in the menu bar, left-click, drag the arrow to IC Exclusions, and left-click.

The IC Exclusions window displays all the specific exclusion item tests or groups of tests for which the SP is eligible and the status for each exclusion item.

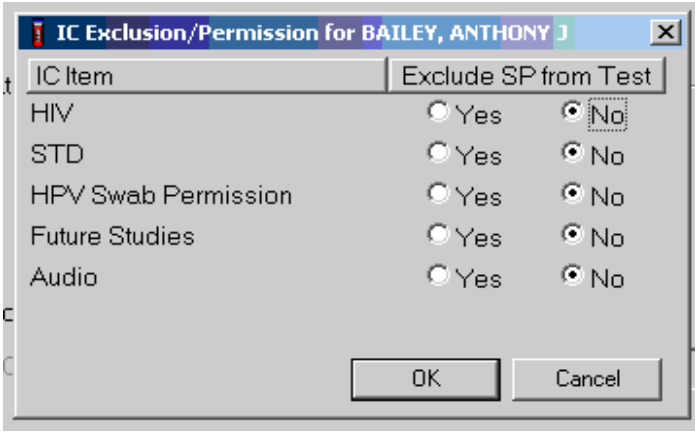

Record each item as directed by the SP. To mark each item, direct the mouse arrow to the “Yes” or “No” radio button and left-click. To record these actions and save them to the database, use the mouse to direct the mouse arrow to the OK button and left-click, or select Enter. To cancel these actions without saving the data to the database, use the mouse to direct the mouse arrow to the Cancel button and left-click.

2.6 Set Session Utility

Sign onto the computer terminal. Open the laboratory application. If the laboratory is conducting a MEC session, the heads-up display will default to the current session. Use the Set Session utility to access past or future sessions.

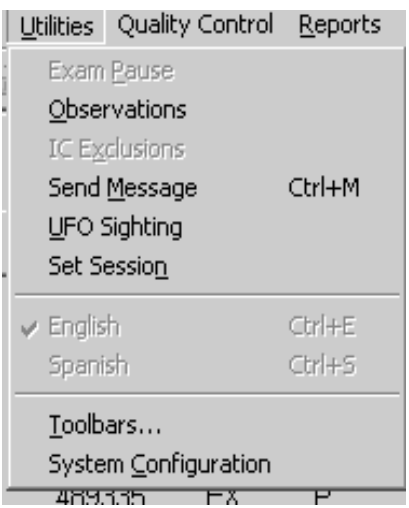

To access the Set Session utility, direct the mouse arrow to Utilities and left-click. Drag the arrow to Set Session and left-click. The Session Pickup list displays. Select the correct session from the pick list.

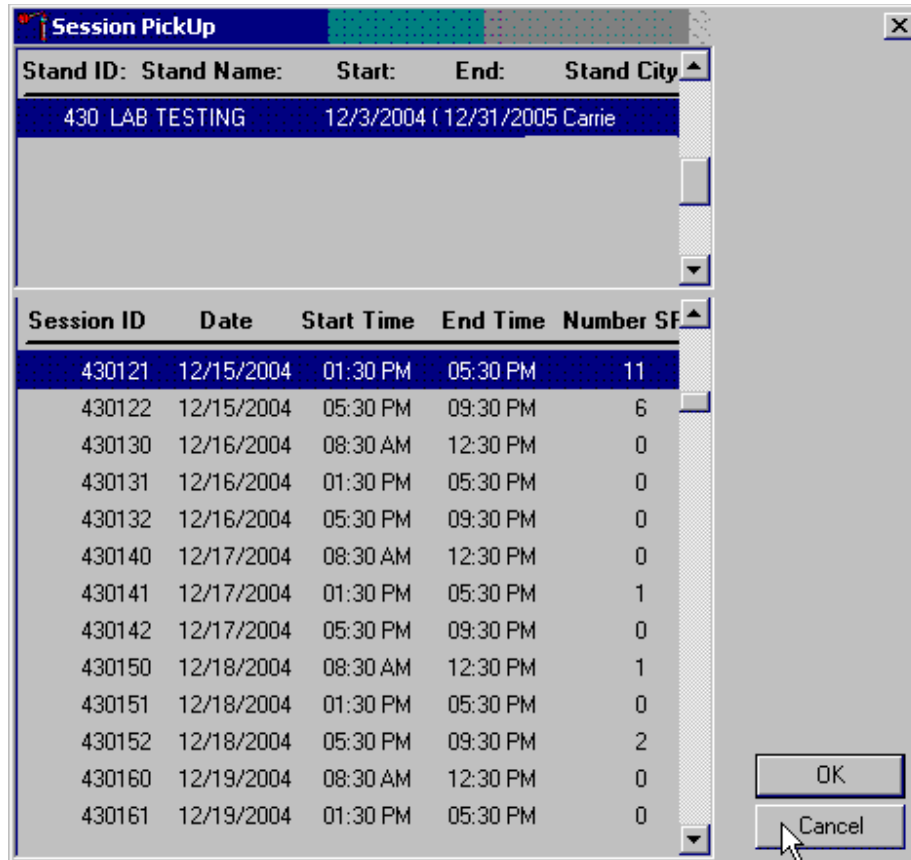

The Session Pickup window displays. The current stand is displayed in the top section of the window. Use the lower vertical scroll bar to view all sessions. Use the mouse to select the desired session. To proceed, hit the OK button or press Enter. To cancel and return to the previous session, click the Cancel button.

After selecting a session from the Session PickUp list and selecting OK, the laboratory heads-up screen displays.

SP ID	Sample ID	Status	Type	Gender	Age	Name	Process Status						HPV	
							UC	U	P	CB	B	PC	F	M
329869	329869	SC	P	F	12	HOWARD, CHARLES S	<input type="radio"/>	<input type="radio"/>	<input type="radio"/>	<input type="radio"/>	<input type="radio"/>	<input type="radio"/>	-	-
386827	386827	SC	P	F	26	DEEGAN, DOUG O	<input type="radio"/>	<input type="radio"/>	<input type="radio"/>	<input type="radio"/>	<input type="radio"/>	-	<input type="radio"/>	-
416714	416714	SC	P	F	16	BAILEY, ANTHONY J	<input type="radio"/>	<input type="radio"/>	<input type="radio"/>	<input type="radio"/>	<input type="radio"/>	<input type="radio"/>	<input type="radio"/>	-
499508	499508	SC	P	F	5	DEEGAN, MARK	<input type="radio"/>	<input type="radio"/>	-	<input type="radio"/>	<input type="radio"/>	-	-	-
525757	525757	SC	P	M	3	LAST NAME, PAT M	<input type="radio"/>	<input type="radio"/>	-	<input type="radio"/>	<input type="radio"/>	-	-	-
745052	745052	SC	P	F	12	TIM, SP FIRST NAME M	<input type="radio"/>	<input type="radio"/>	<input type="radio"/>	<input type="radio"/>	<input type="radio"/>	-	-	-
767995	767995	SC	P	F	39	NAME, LAST M	<input type="radio"/>	<input type="radio"/>	<input type="radio"/>	<input type="radio"/>	<input type="radio"/>	-	<input type="radio"/>	-
836040	836040	SC	P	M	54	TORRES, LUCAS T	<input type="radio"/>	<input type="radio"/>	-	<input type="radio"/>	<input type="radio"/>	-	-	<input type="radio"/>
849425	849425	SC	P	F	16	CAMPBELL, VINNIE N	<input type="radio"/>	<input type="radio"/>	<input type="radio"/>	<input type="radio"/>	<input type="radio"/>	<input type="radio"/>	<input type="radio"/>	-
919919	919919	SC	P	M	57	PAYNE, IMA L	<input type="radio"/>	<input type="radio"/>	-	<input type="radio"/>	<input type="radio"/>	<input type="radio"/>	-	<input type="radio"/>

2.7 Container Map

Check the slot assignment of all containers at the end of each session. Access the Container Map report under the Reports or Shipping menu.

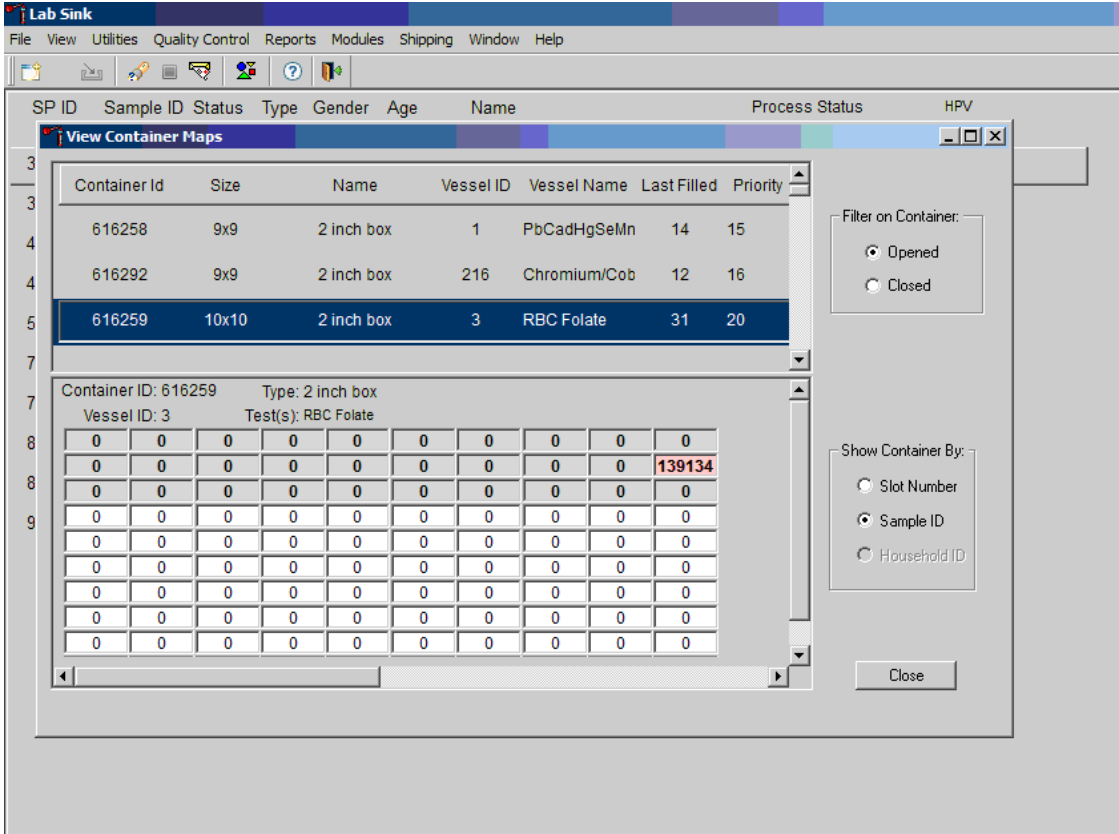

Use Container Mapping to verify the contents of each container.

- Use as a reference for determining the position of each vessel within a container.
- If “Opened” under “Filter on Container” is selected, then all open containers will display.
- If “Sample ID” under “Show Container By:” is selected, then sample IDs will display in the assigned slot in the graphical representation of the container.
- Container IDs may be selected by mouse or by using the up and down keys.
- Verify the container ID on the box against the container ID listed on the screen and verify each vessel sample ID against its location in the map.

To exit the Container Map report, click the Close button.

2.8 Content Container Verification

Use Container Content Verification to verify the contents of each container.

- Access to container verification is located under the shipping tab from the lab’s heads up display.
- Perform container verification after each session.
- Verify the container ID on the box against the container ID listed on the screen and verify each vessel sample ID against its location in the system.
- Mark the specimens that have been checked by placing a mark unique to each medical technologist in the center of the vial cap. When subsequently checking the Container content verification system for this container, begin checking the first specimen after the unique mark.

The screenshot shows the 'Lab Sink' software interface. The 'Shipping' menu is open, displaying options: 'Print New Container Labels', 'Container Map', 'Close Containers', 'Assign Containers to Shippers', 'Trash Containers', 'Shipping Manifest', and 'Container Content Verification'. The background table lists shipping containers with columns for SP ID, Sample ID, Status, Type, Gender, and Name. To the right, a 'Process Status' table shows columns for UC, U, P, CB, B, PC, HPV (F, M), each with a corresponding radio button.

SP ID	Sample ID	Status	Type	Gender	Name	Process Status							
						UC	U	P	CB	B	PC	F	M
329869	329869	SC	P	F		<input type="radio"/>	<input type="radio"/>	<input type="radio"/>	<input type="radio"/>	<input type="radio"/>	<input type="radio"/>	<input type="radio"/>	<input type="radio"/>
386827	386827	SC	P	F		<input type="radio"/>	<input type="radio"/>	<input type="radio"/>	<input type="radio"/>	<input type="radio"/>	<input type="radio"/>	<input type="radio"/>	<input type="radio"/>
416714	416714	SC	P	F	16 BAILEY, ANTHONY J	<input type="radio"/>	<input type="radio"/>	<input type="radio"/>	<input type="radio"/>	<input type="radio"/>	<input type="radio"/>	<input type="radio"/>	<input type="radio"/>
499508	499508	SC	P	F	5 DEEGAN, MARK	<input type="radio"/>	<input type="radio"/>	<input type="radio"/>	<input type="radio"/>	<input type="radio"/>	<input type="radio"/>	<input type="radio"/>	<input type="radio"/>
525757	525757	SC	P	M	3 LAST NAME, PAT M	<input type="radio"/>	<input type="radio"/>	<input type="radio"/>	<input type="radio"/>	<input type="radio"/>	<input type="radio"/>	<input type="radio"/>	<input type="radio"/>
745052	745052	SC	P	F	12 TIM, SP FIRST NAME M	<input type="radio"/>	<input type="radio"/>	<input type="radio"/>	<input type="radio"/>	<input type="radio"/>	<input type="radio"/>	<input type="radio"/>	<input type="radio"/>
767995	767995	SC	P	F	39 NAME, LAST M	<input type="radio"/>	<input type="radio"/>	<input type="radio"/>	<input type="radio"/>	<input type="radio"/>	<input type="radio"/>	<input type="radio"/>	<input type="radio"/>
836040	836040	SC	P	M	54 TORRES, LUCAS T	<input type="radio"/>	<input type="radio"/>	<input type="radio"/>	<input type="radio"/>	<input type="radio"/>	<input type="radio"/>	<input type="radio"/>	<input type="radio"/>
849425	849425	SC	P	F	16 CAMPBELL, VINNIE N	<input type="radio"/>	<input type="radio"/>	<input type="radio"/>	<input type="radio"/>	<input type="radio"/>	<input type="radio"/>	<input type="radio"/>	<input type="radio"/>
919919	919919	SC	P	M	57 PAYNE, IMA L	<input type="radio"/>	<input type="radio"/>	<input type="radio"/>	<input type="radio"/>	<input type="radio"/>	<input type="radio"/>	<input type="radio"/>	<input type="radio"/>

The container content verification includes the container ID, container size, name of container, vessel ID, vessel name, last filled slot #, vessel priority number, and the number of unverified vessels remaining.

- There is an indicator for opened or closed filters on containers.
- Save and Next button saves your work and opens the container that is next in the list.
- To save your work and exit the application, use the OK button.
- To cancel your current work and exit the application, use the Cancel button.

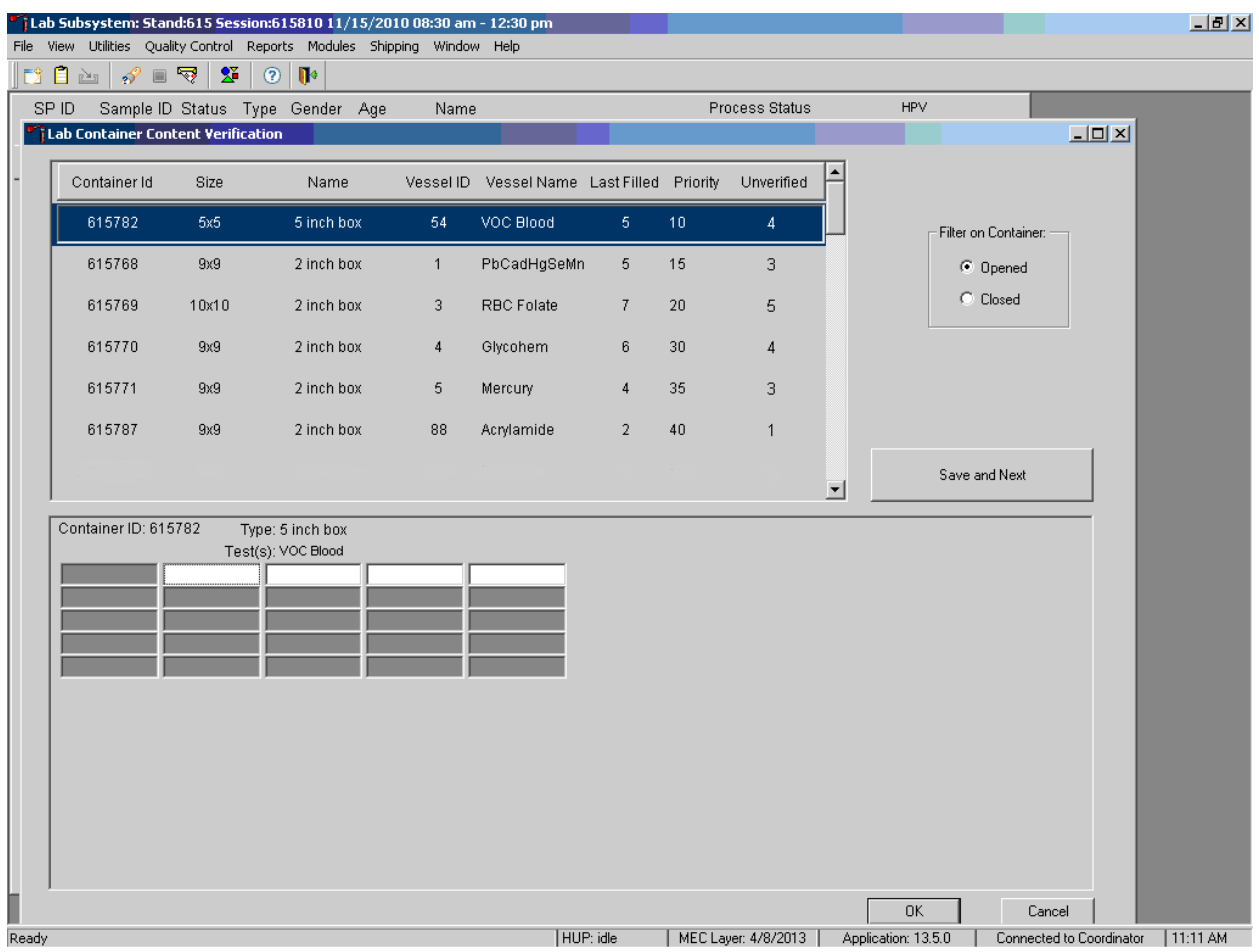

To use the container content verification application, remove a container from the freezer; using the bar code gun, scan the Sample ID or the Astro ID of the first vessel to be verified. If correct vessel is scanned in, the sample ID will be displayed in green.

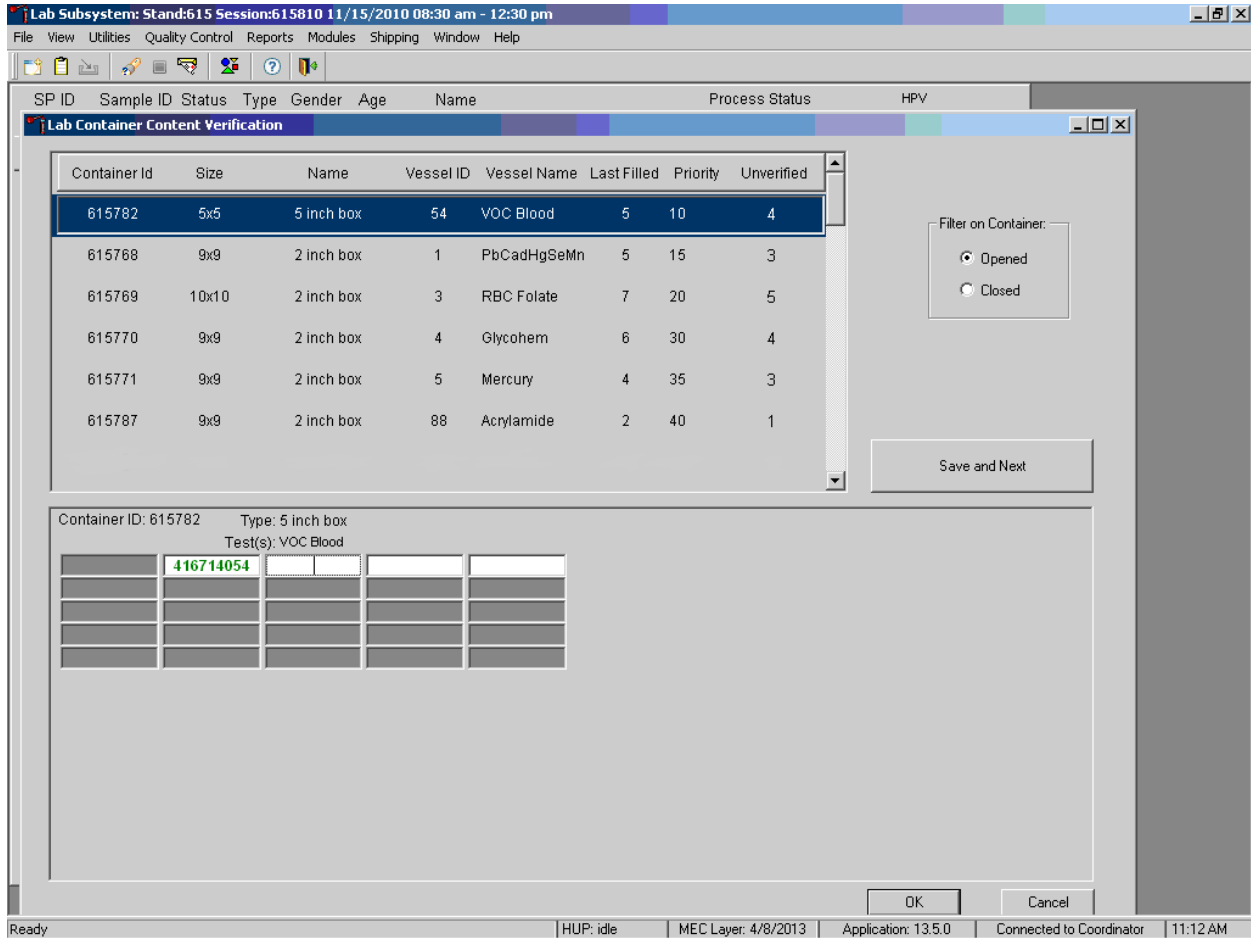

If incorrect vessel is scanned, the following will happen:

- The sample # will be highlighted in blue; this allows the user to rescan the correct vessel without deleting the incorrect #.
- A pop-up box will be displayed indicating the correct contents of that slot.

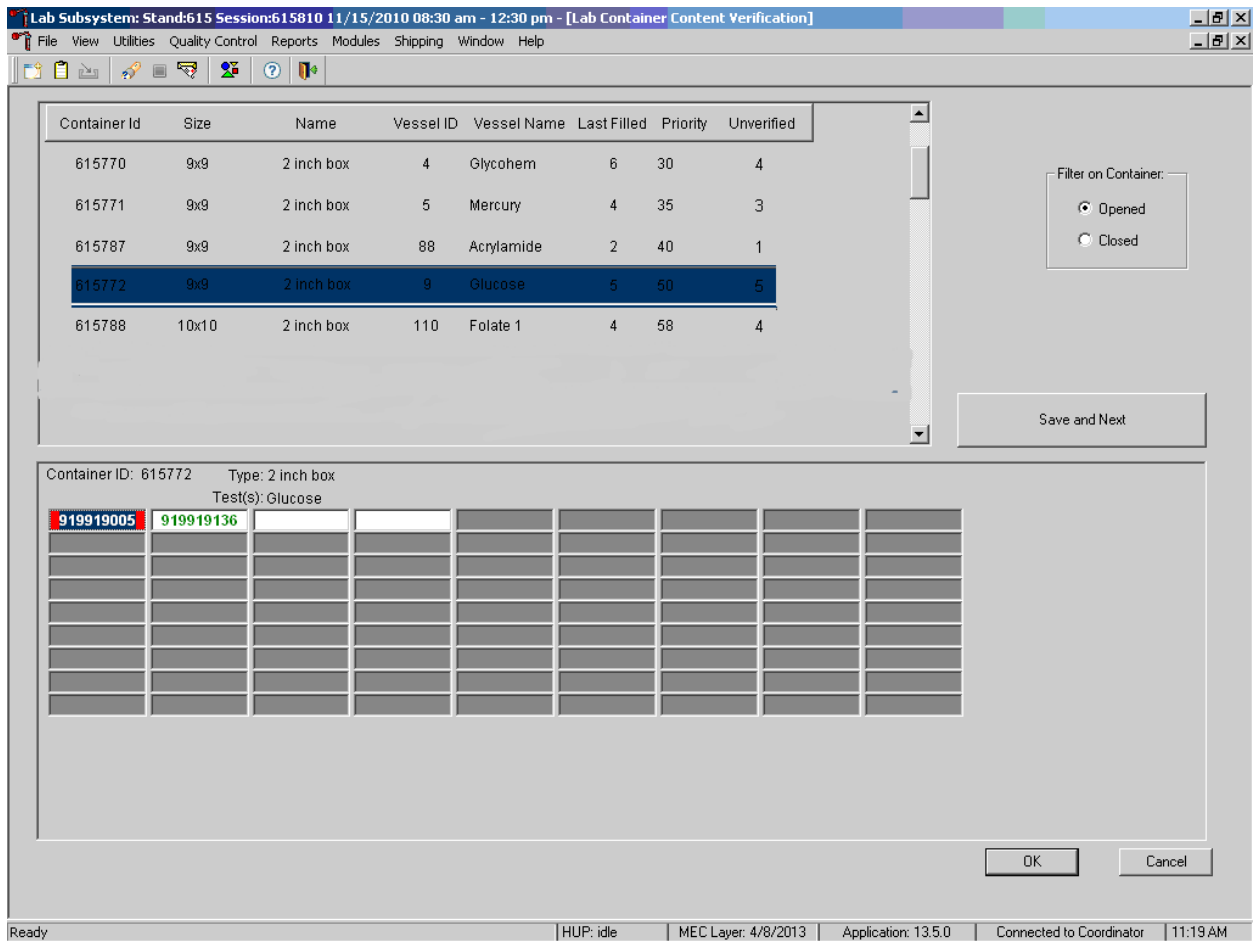

The following screenshot shows a vessel that requires a red cap insert and an incorrect vessel side-by-side. The red cap insert is identified with a red outline around the box of the vessel, whereas the incorrect specimen number is highlighted in blue with red shading underneath.

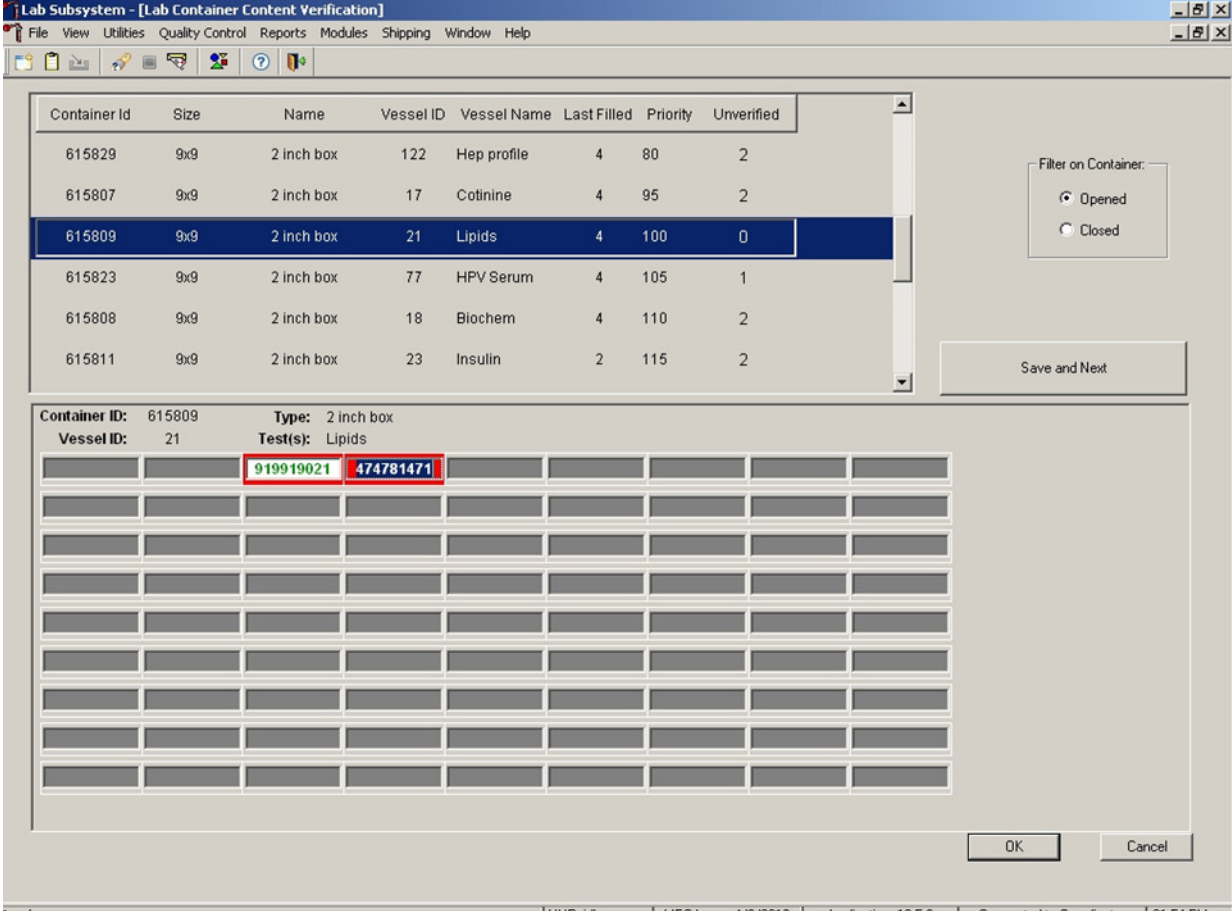

If you encounter an empty slot:

- You must tab off that slot to the next available slot to continue.
- This serves as verification for the empty slot.
- If you scan a vessel in a slot that should be empty, a pop-up box will appear saying the slot should be empty.
 - Hit OK to verify message.
 - Tab to next slot.

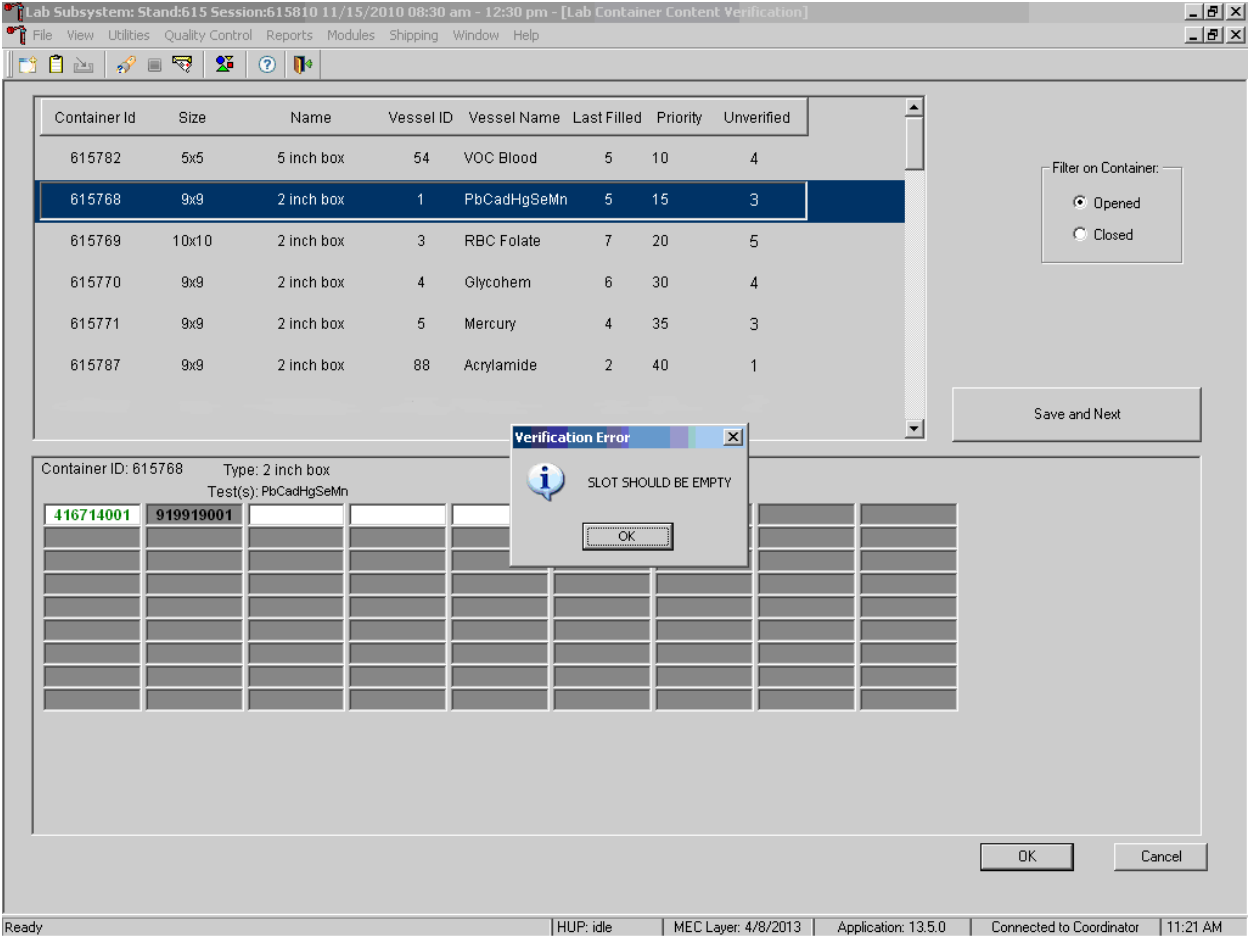

To save your verification, you must hit the Save and Next button or OK button. If you hit the cancel button, your last scanned vessel will not be saved.

- The enter key is the same as hitting the OK button on the pop-up boxes.
- The enter key is the same as hitting the OK box on the verification screen.
 - It will save your work and exit you from the verification screen.

2.9 Subsample Preview

Access the Subsample Preview to view all SPs in the current session and the selected subsamples for which they are eligible.

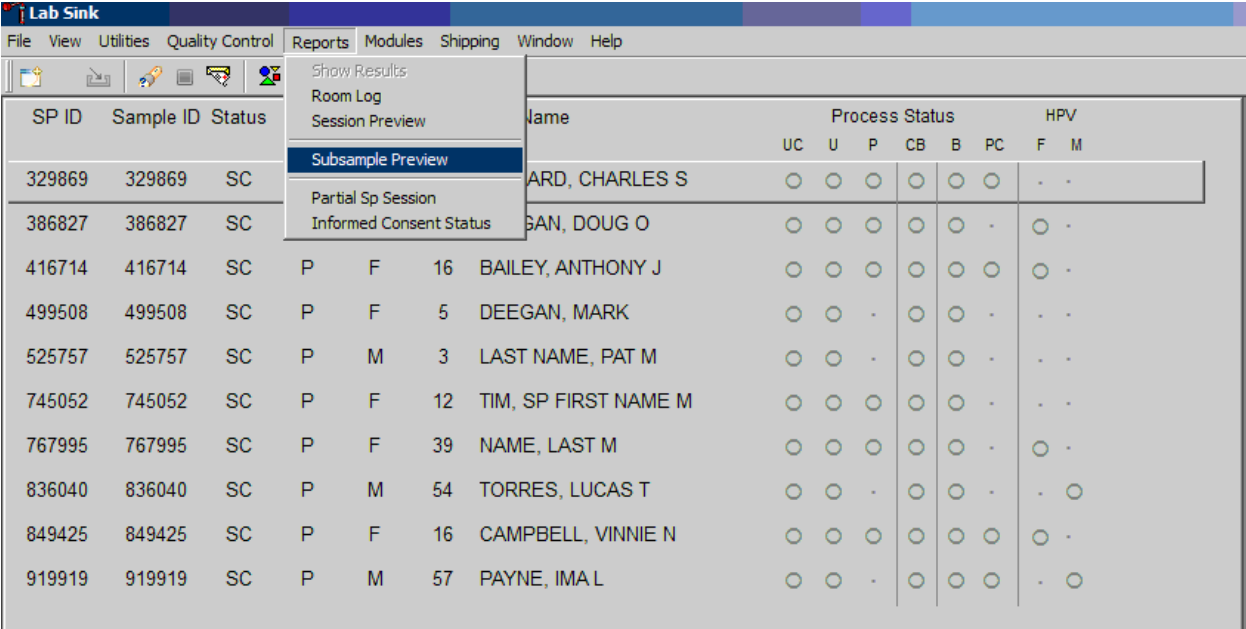

Access the Subsample Preview report under Reports in the menu bar.

Review the Subsample Preview report.

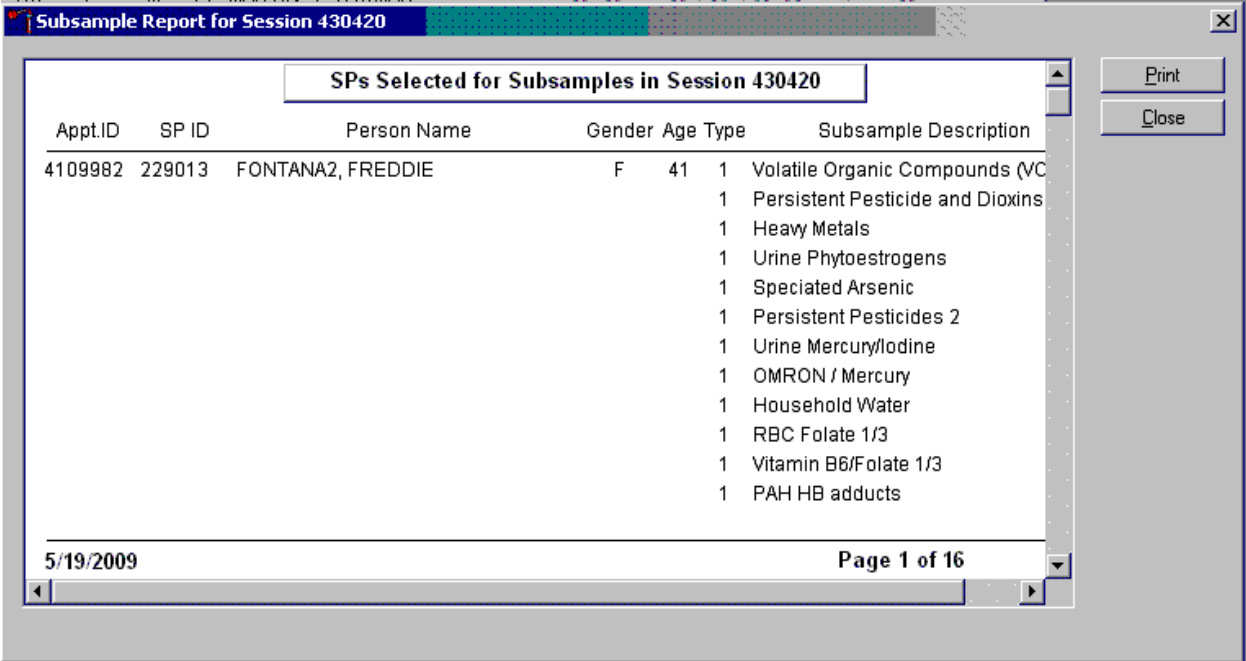

The Subsample Preview report includes all SPs assigned to the current session and the subsamples for which they are eligible. This report contains the appointment ID, SP ID, person name, gender, age, appointment type, and subsample description. Only SPs selected for inclusion in specific subsamples are eligible to have the related vessel filled. To view the entire report, use the scroll bar. To print a copy of the report, direct the mouse arrow to the Print button and left-click. To exit and close the report, click the Close button.

2.10 Informed Consent Status

Access the Informed Consent Status report to view SPs and the status of the informed consent result for various tests and/or groups of tests.

SP ID	Sample ID	Status	Name	Process Status						HPV	
				UC	U	P	CB	B	PC	F	M
329869	329869	SC	ARD, CHARLES S	<input type="radio"/>	<input type="radio"/>	<input type="radio"/>	<input type="radio"/>	<input type="radio"/>	<input type="radio"/>	-	-
386827	386827	SC	BAN, DOUG O	<input type="radio"/>	<input type="radio"/>	<input type="radio"/>	<input type="radio"/>	<input type="radio"/>	-	<input type="radio"/>	-
416714	416714	SC	P F 16 BAILEY, ANTHONY J	<input type="radio"/>	<input type="radio"/>	<input type="radio"/>	<input type="radio"/>	<input type="radio"/>	<input type="radio"/>	<input type="radio"/>	-
499508	499508	SC	P F 5 DEEGAN, MARK	<input type="radio"/>	<input type="radio"/>	-	<input type="radio"/>	<input type="radio"/>	-	-	-
525757	525757	SC	P M 3 LAST NAME, PAT M	<input type="radio"/>	<input type="radio"/>	-	<input type="radio"/>	<input type="radio"/>	-	-	-
745052	745052	SC	P F 12 TIM, SP FIRST NAME M	<input type="radio"/>	<input type="radio"/>	<input type="radio"/>	<input type="radio"/>	<input type="radio"/>	-	-	-
767995	767995	SC	P F 39 NAME, LAST M	<input type="radio"/>	<input type="radio"/>	<input type="radio"/>	<input type="radio"/>	<input type="radio"/>	-	<input type="radio"/>	-
836040	836040	SC	P M 54 TORRES, LUCAS T	<input type="radio"/>	<input type="radio"/>	-	<input type="radio"/>	<input type="radio"/>	-	-	<input type="radio"/>
849425	849425	SC	P F 16 CAMPBELL, VINNIE N	<input type="radio"/>	<input type="radio"/>	<input type="radio"/>	<input type="radio"/>	<input type="radio"/>	<input type="radio"/>	<input type="radio"/>	-
919919	919919	SC	P M 57 PAYNE, IMA L	<input type="radio"/>	<input type="radio"/>	-	<input type="radio"/>	<input type="radio"/>	<input type="radio"/>	-	<input type="radio"/>

Access the Informed Consent Status report under the Reports menu in the menu bar.

Review the SPs scheduled into the current session and the status of their informed consent by using the Informed Consent Status report.

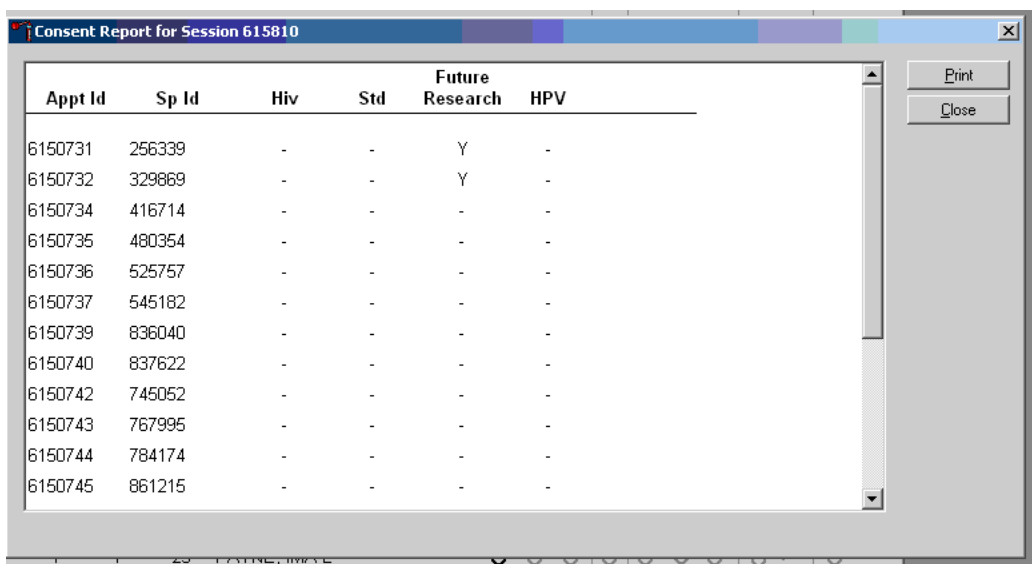

Appt Id	Sp Id	Hiv	Std	Future Research	HPV
6150731	256339	-	-	Y	-
6150732	329869	-	-	Y	-
6150734	416714	-	-	-	-
6150735	480354	-	-	-	-
6150736	525757	-	-	-	-
6150737	545182	-	-	-	-
6150739	836040	-	-	-	-
6150740	837622	-	-	-	-
6150742	745052	-	-	-	-
6150743	767995	-	-	-	-
6150744	784174	-	-	-	-
6150745	861215	-	-	-	-

The consent report lists all SPs scheduled in the current session, their appointment and SP IDs, and the exclusion status for the following tests or groups of tests:

- HIV (vessel 22 – serum);
- STD (vessel 24 – HSV);
- Future research (32-39 – serum, 52 and 139 – urine); and
- HPV Swab (vessel 78 and vessel 140).

The status is “Y” or “Yes” if the SP is excluded and “N” if the SP is not excluded.

2.11 Access a Processing Module

Select the correct SP and access the module of interest. Use the scroll bar to view all SPs scheduled into the session. The active SP is contained in a rectangular box. Use the heads-up display to select the correct SP. Select a different SP if the active SP is not the correct SP.

SP ID	Sample ID	Status	Type	Gender	Age	Name	Process Status							
							UC	U	P	CB	B	PC	F	M
329869	329869	SC	P	F	12	HOWARD, CHARLES S	<input type="radio"/>	<input type="radio"/>	<input type="radio"/>	<input type="radio"/>	<input type="radio"/>	<input type="radio"/>	<input type="radio"/>	<input type="radio"/>
386827	386827	SC	P	F	26	DEEGAN, DOUG O	<input type="radio"/>	<input type="radio"/>	<input type="radio"/>	<input type="radio"/>	<input type="radio"/>	<input type="radio"/>	<input type="radio"/>	<input type="radio"/>
416714	416714	SC	P	F	16	BAILEY, ANTHONY J	<input type="radio"/>	<input type="radio"/>	<input type="radio"/>	<input type="radio"/>	<input type="radio"/>	<input type="radio"/>	<input type="radio"/>	<input type="radio"/>
499508	499508	SC	P	F			<input type="radio"/>	<input type="radio"/>	<input type="radio"/>	<input type="radio"/>	<input type="radio"/>	<input type="radio"/>	<input type="radio"/>	<input type="radio"/>
525757	525757	SC	P	M			<input type="radio"/>	<input type="radio"/>	<input type="radio"/>	<input type="radio"/>	<input type="radio"/>	<input type="radio"/>	<input type="radio"/>	<input type="radio"/>
745052	745052	SC	P	F			<input type="radio"/>	<input type="radio"/>	<input type="radio"/>	<input type="radio"/>	<input type="radio"/>	<input type="radio"/>	<input type="radio"/>	<input type="radio"/>
767995	767995	SC	P	F			<input type="radio"/>	<input type="radio"/>	<input type="radio"/>	<input type="radio"/>	<input type="radio"/>	<input type="radio"/>	<input type="radio"/>	<input type="radio"/>
836040	836040	SC	P	M			<input type="radio"/>	<input type="radio"/>	<input type="radio"/>	<input type="radio"/>	<input type="radio"/>	<input type="radio"/>	<input type="radio"/>	<input type="radio"/>
849425	849425	SC	P	F			<input type="radio"/>	<input type="radio"/>	<input type="radio"/>	<input type="radio"/>	<input type="radio"/>	<input type="radio"/>	<input type="radio"/>	<input type="radio"/>

To select an SP, use the up and down keys to move up and down the list until the correct SP is highlighted or click the SP. To access a specific processing module, click the module on the heads-up screen: UC {Urine Collection}, U {Urine Processing}, P {Pregnancy Testing}, CB {Hematology}, B {Blood Processing}, PC {Packed Cell Processing}, or HPV {HPV Processing (Male or Female)}, and left-click. Alternatively, right-click on an SP and select the correct module.

2.12 Warning and Error Messages

Throughout the course of an examination, warning and error messages may appear when an attempt is made to perform an action the program cannot execute or that requires confirmation to continue the action. The message normally appears with statements explaining the error condition. Complying with the error message statement will normally remedy the error. When required to confirm an

action, such as deleting records, be sure the action is necessary because, in most cases, it is irreversible.

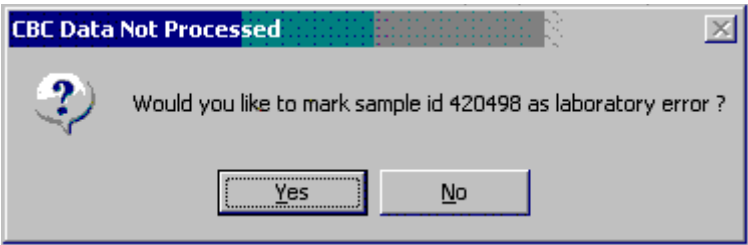

For example, if the SP ID is incorrect in the SP Logon window, a warning message box displays indicating the problem and giving remedial instructions. To remove the warning message box, click the OK button.

2.12.1 Not Filled Require a Comment

Data cannot be saved until all vessels marked as Filled–No are assigned a comment.



If the Save or the OK button is selected and all vessels are not marked as either Filled–Yes or Filled–No, a warning message box displays requesting a comment for each unfilled vessel. To remove the warning message box, click the OK button.

2.12.2 Labels Must be Printed in Advance

If labels have not been printed in advance, all SPs will be displayed in red. A pop-up box will appear with Label Action Required.

Specimen processing cannot occur unless labels have been printed in advance. Reprint the labels for all SPs or an individual SP in a session. See Chapter 9 for detailed instructions on the Lab Print Application.

2.13 Coulter and Urine Scale Icons

Coulter

This is the NHANES Coulter[®] Monitor. It must be open and running at the start of each session. This icon stores all DxH[™] 800 runs in the ISIS database. Open the icon by double-clicking on the Coulter icon on the desktop. The Coulter icon looks like this:



Note the red icon in the lower left hand corner of the system tray.



NOTE: If there is an interface problem with the database and the Coulter application, the Hematology module does not need to be open before running SP samples on the DxH 800. The SP's CBC results can be transmitted to the database at a later time after the interfaces between the database and the DxH800 are restored.

Urine Scale

Ensure that computer workstation 1 (Urine/Sink) is turned on and a technician is logged into the Laboratory application. Open the Urine Scale application by double-clicking on the Urine Scale icon on the desktop. The Urine Scale icon looks like this:



The Urine Scale application icon will appear in the system tray, similar to the Coulter application. This application captures data from the scale and logs it into the database. The Urine Scale application must be opened and in the system tray in order to capture any urine collection readings from the scale.



3.1 Introduction

The blood collection procedure consists of (1) administering a questionnaire to screen for conditions that exclude the participant from the blood draw; (2) determining fasting status; and (3) performing a blood draw. The phlebotomist also collects one additional blood tube from study participants (SPs) selected for the VOC (volatile organic compounds) special study.

The phlebotomist conducts an interview to screen SPs for conditions that exclude them from the blood draw. The phlebotomist also administers a fasting questionnaire to determine fasting compliance. The venipuncture protocol is dependent on the SP's age, appointment type, and session time. Exhibits 3-1 through 3-3 illustrate the various venipuncture protocols. These protocols indicate the types and numbers of tubes in priority order for each age group and person type. A chart located on the wall in the phlebotomy room also illustrates this information. It is extremely important to perform the venipuncture protocol as described for each SP. Document any comments to describe differences between the actual tubes drawn and the established protocol. After the results of the blood draw are entered, labels automatically print for the blood tubes. The phlebotomist immediately labels collected tubes and places them through the pass-through window to the laboratory. All SPs are offered juice and cookies immediately after their blood draw, in the afternoon and evening sessions to be consumed after completion of the Liver Ultrasound Transient Elastography component, if eligible. Then the phlebotomist escorts the SP to the coordinator area or to his or her next component.

Exhibit 3-1. Venipuncture protocol – primary

	Age in years				
	1-2	3-5	6-11	12-19	20+
3-ml lavender	1	2			1 ¹
4-ml lavender			2	2	2
2-ml gray (morning sessions only)				1	1
3-ml red	2				
7-ml red		2	1	1	1
15-ml red				2	2
10-ml red			1		
15-ml red ²				3	3
7-ml gray (12+) ³				1	1
¹ SPs 40+ ² SPs selected for inclusion in the Persistent Pesticides, Perfluorinated or BFR subsamples. ³ SPs selected for inclusion in the volatile organic compound (VOC) subsample.					

Exhibit 3-2. Venipuncture protocol – guest

	Guest profile age in years	
	1-11	12+
3-ml lavender	1	1
3-ml red		1

If the veins of an SP appear too fragile to accommodate the size of the large red-top tubes, substitute smaller red-top tubes as an alternative protocol. Exhibit 3-3, Alternative venipuncture protocol—primary, illustrates the alternative size and number of tubes in boldface with the original tube protocol in parentheses. When the alternative protocol is substituted for the original protocol, a comment must be recorded. This protocol constitutes a deviation from the established standard; it should be used only in rare circumstances.

Exhibit 3-3. Alternative venipuncture protocol — primary

	Age In years		
	3-5	6-11	12+
3-ml red	3	2	
7-ml red	(1)	2(1)	4
15-ml red			(2)
10-ml red		(1)	5
15-ml red			(3)

NOTE: Alternative venipuncture protocol tubes are shown in boldface; regular protocol tubes are shown in parentheses.

3.2 Equipment and Supplies

The phlebotomy room contains a phlebotomy chair, sink, data terminal, Dymo direct thermal label printer, refrigerator, and cabinets. Figure 3-1 illustrates the floor plan for the phlebotomy room.

Figure 3-1. Floor plan for phlebotomy room



At the start and end of each stand, take a complete inventory using procedures described in Chapter 13, Section 13.3.

The equipment and supplies used in venipuncture are listed in Exhibit 3-4.

Exhibit 3-4. Equipment and supplies – phlebotomy

Consumable supplies	
BD Hemogard Vacutainer® 3-mL EDTA	
BD Hemogard Vacutainer® 4-mL EDTA	
BD Hemogard Vacutainer® 2-mL gray	Alcohol wipe
BD Hemogard Vacutainer® 3-mL red	2" x 2" gauze square
Covidien 7-mL red	Co-Flex NL cohesive bandage
Covidien 15-mL red	Adhesive bandage – Coverlet
BD Vacutainer® 10-mL red	Venolite Disposable Covers
BD Vacutainer® 7-mL gray (VOC)	Transpore tape
Nipro 19 gauge x 3/4" Butterfly Needles	
Nipro Luer adapter for use with the 19 gauge Saf- T EZ® set	White Ice Wings – Disposable Ice Cubes
Nipro 21 gauge x 3/4" Butterfly Needles	Cartoon stickers
Nipro 23 gauge with adapter	Ammonia ampules
BD Vacutainer® needle holder – single use	Pillow and disposable pillow cover
Air sickness bag	Squeeze ball
Heel warmer	Juice (apple/orange) and Animal crackers
Sani-Cloth	List of reportable tests (handout) English and Spanish
Purell hand soap	Labels for Dymo printer
Medicine cup and disposable straws	Bio-Hazard Sharps container 2 gallon (8 qt.)
Stretch disposable tourniquet	Batteries, AA
Magic Marker – Ultra Fine Sharpie - Black	Batteries, AAA
Emergency blanket	Magic Marker –Fine Point Sharpie - Black
VeinLite EMS	CPR Mask - Adult
Nonconsumable supplies	
Step stool – bariatric	Tube racks
Solar wall thermometer	Buzzy Bee
Plastic supply baskets	Portable scale
Emergency supplies	
Obtain from lab	
Hand cream	Facial tissue
Nonsterile, powder-free, nonlatex gloves – small, medium, large	Bleach bottle
Disposable lab coats (M, L, XL, XXL)	

For each SP, the phlebotomist routinely requires the following materials:

- Alcohol wipes
- 2" x 2" gauze squares
- Vacutainer® tubes of the appropriate size and type
- Disposable tourniquet

- Needle assembly
- Bandage

3.3 Overview

The coordinator tracks each SP through the MEC using the coordinator system. This system tracks the SP throughout the exam, including arrival, location during the session, and exit. The coordinator uses this system to direct the SP to the appropriate workstations in the MEC and to determine if all the appropriate examinations are complete. The MEC coordinator monitors exam component status using responses from examination stations.

It is critical to assign SPs aged 12 years and older to phlebotomy as soon as possible at the start of a session, especially a morning session. The coordinator gives each SP a hard-copy verification form as part of the check-in process. For SPs aged 12 years and older who are examined during a morning session, the form includes the question, “Did you eat or drink anything, other than plain water, after 11:30 p.m. last night?” The SP records “Yes” or “No” in a checkbox and the coordinator enters this information into the coordinator application. The coordinator application then highlights (hot pink) the names of SPs who responded “Yes” since they have not met the 9-hour fast requirement. The coordinator uses the highlighted names to aid in prioritizing SPs for the phlebotomy component; SPs who are not highlighted are assigned to phlebotomy before SPs whose names are highlighted.

Each SP receives a bar-coded ID bracelet upon arrival at the MEC. The bracelet remains on the SP throughout the session. This bracelet contains the SP’s ID number in barcode and eye-readable format. The phlebotomist “wands” the bracelet barcode with a barcode scanner (wand) to log the SP into the phlebotomy component. If necessary, the ID number can be entered manually by reading it from the bracelet and typing the numbers using the keyboard.

The phlebotomist is responsible for completing the venipuncture section of the phlebotomy exam.

Phlebotomy Seating Options. The UMF 8678 phlebotomy chair (Figure 3-2) features an electric motor for up and down patient positioning, three positions—upright, recline, and full recline—and fully adjustable padded armrests that recline as the patient reclines. The chair includes both hand-operated and foot-operated controls to recline the chair with a touch of a button. To recline the chair, push the bottom button on the controller. The foot support will rise and the armrests will recline with the chair.

Figure 3-2. UMF 8678 phlebotomy chair



For the blood draw, the seating options are dependent on the weight of the SP. The chair weight restriction is 375 lbs. If the phlebotomist estimates that the weight of the SP is less than 375 lbs, and the SP will fit comfortably in the phlebotomy chair, then ask the SP to sit in the chair. If the SP exceeds the capacity of the chair, use a chair from the staff lounge to comfortably and safely seat the SP. If the SP feels faint and is sitting in the electronic chair, then recline the chair either before or during the blood draw as needed. Roll wheelchairs completely into the room.

Access the phlebotomy application and open the phlebotomy exam. Log the SP into phlebotomy by scanning the barcode on the SP ID bracelet or manually typing the SP ID when the SP arrives in phlebotomy.

Conduct the phlebotomy interview and administer the fasting questionnaire. The phlebotomy protocol screen will display. Draw the appropriate tubes, discard all sharps in the 8-quart biohazard container, and enter the number of tubes collected next to the expected values. Labels generate

automatically. Enter the appropriate comment(s) for any tube that was not collected. Label the blood tubes. Verify that the phlebotomy completion status is correct. The phlebotomy section status is “Complete” if all blood tubes are collected, “Partial” if some but not all blood tubes are collected, and “Not Done” if no blood tubes are collected.

3.4 Gaining Cooperation

The coordinator will introduce the SP to the examination and briefly explain the examination process. The coordinator can answer any general questions the SP has about venipuncture. However, the phlebotomist must be prepared to answer all the questions the SP poses about the venipuncture procedure. In addition, the phlebotomist must convey the importance of cooperation in the venipuncture component of the examination.

Prepare to answer questions about the rationale for the venipuncture, the discomfort involved, the amount of blood being drawn, and the possibility of contracting an infectious disease from the process. To address SPs’ concerns effectively, know the following information about the procedures used for the study:

Rationale

Although the SP has provided much useful information in the household and individual interviews, the successful completion of the venipuncture component of NHANES is critical to the success of the study. Using the various specimens, researchers and laboratories are able to perform more than 250 different biochemical tests (SPs 12+), which provide detailed information about the SP’s health and nutritional status. NHANES data produce descriptive statistics that measure and monitor the health of the U.S. population. Much of this information would not be available in any other way. The laboratories that conduct the analysis are considered the “gold standard” for their particular analyte(s).

Discomfort. Venipuncture causes only minimal discomfort. A certified, experienced, phlebotomist performs venipunctures. A variety of blood collection needles are available so that the most appropriate size can be selected for each SP.

Amount. Phlebotomists draw the following amount of blood:

- 1-2 years primary SP, 9-ml (0.3 ounces), 0.6 tablespoons
- 3-5 years primary SP, 13-ml (0.5 ounces), 1.0 tablespoons
- 6-11 years primary SP, 32-ml (1.0 ounces), 2.0 tablespoons
- 12-19 years primary SP, 108-ml (3.6 ounces), 7.2 tablespoons
- 20+ years primary SP, 111-ml (3.9 ounces), 7.8 tablespoons
- Guests, 6-ml (0.2 ounces), 0.4 tablespoons

An average adult male has 12 pints of blood and an average female has 9 pints. The Red Cross routinely draws 450-ml (or one pint) during a routine donation. Their requirements limit donation to every 8 weeks. The maximum volume drawn during a MEC exam amounts to slightly more than 25 percent (128-ml) of the amount drawn from regular donors by the Red Cross. The body manufactures blood daily and replaces this volume of blood within 24 hours.

Infection Control. The supplies used for venipuncture are completely sterile and are used only once. There is absolutely no possibility of the SPs being infected by any blood-borne disease, such as hepatitis or HIV, because of participation in the venipuncture component of the NHANES exam.

Gaining the cooperation of an SP is easier if the atmosphere in the phlebotomy room is pleasant and makes the SP feel comfortable. Below is a list of suggestions for creating a pleasant atmosphere in the phlebotomy room.

- Maintain a clean and uncluttered work area. This is especially important because of today's concern with blood-borne infectious diseases, such as hepatitis and HIV.
- Be aware of body image; a positive body image inspires confidence. Maintain a tidy appearance, erect posture, and a smile.
- Speak face to face with the subject and maintain eye contact. Staring at other areas in the room may cause the SP some uneasiness since it implies that he or she is not important. It also implies disinterest.
- Avoid nervous behaviors, such as squirming and tapping that can be distracting. The SP may begin to feel nervous, hurried, and anxious because of such behaviors.

3.4.1 Refusal Conversion

The phlebotomy component maintains the highest priority among MEC examinations. If an SP comes to the MEC and can complete only one exam, it should be the phlebotomy component.

The field office and interviewing teams use “Special Consideration” codes to describe SPs with reservations about the phlebotomy procedure. The codes are part of the special consideration section of the MEC Appointment Schedule in the coordinator application. The phlebotomist prints the Session Preview Report each session and notes CB/NB codes under the Special Considerations column. The codes entered by the interviewers should be viewed as “warning codes” rather than strict edicts.

- When an SP expressed no reservations or concerns about phlebotomy during the home interview, no code will appear, and no special action is needed from MEC staff.
- **CB**—represents “Convert Blood”—this means that the SP has expressed concern or fear about the blood draw, but did not indicate that he or she intends to refuse having blood drawn. If an SP is coded CB, phlebotomy remains a priority exam.
- **NB**—represents “No Blood”—this means the SP indicated during the home interview that he or she intended to refuse the blood draw. When an SP has a NB code, the coordinator may send the SP to phlebotomy either (1) after all other SPs have completed phlebotomy or (2) after the SP has completed the exams in the profile. The coordinator should use the following script to simply explain that “We need to send you to the exam room; we can scan your ID band barcode into the system.”

The MEC manager and coordinator should work in collaboration with the phlebotomist in assigning the NB-coded SPs; the phlebotomist is trained in refusal conversion techniques and is responsible for the overall response rate for this component. At all times, the coordinator and MEC manager must use their judgment in assigning SPs with NB to phlebotomy. If the SP is vehemently adamant about not giving blood, there is no reason to provoke the SP by sending him or her to the phlebotomy room. In this instance, the coordinator will mark the phlebotomy component as a refusal.

3.5 Performing the Venipuncture on SPs Who Do Not Speak English

When the phlebotomist must administer the venipuncture procedure to an SP who does not speak English and the phlebotomist does not speak the language of the SP, a translator who does speak the language of the SP assists the phlebotomist. The translator stays with the phlebotomist and the SP for the entire procedure. It is very important that the phlebotomist be able to communicate with the SP if the SP becomes ill during the venipuncture. Refer to the MEC Operations manual for detailed instructions on the interpreter module.

3.6 Open the Exam and Log the SP into the Exam

Open and log onto the Phlebotomy application. The message center window identifies the SP assigned to Phlebotomy.

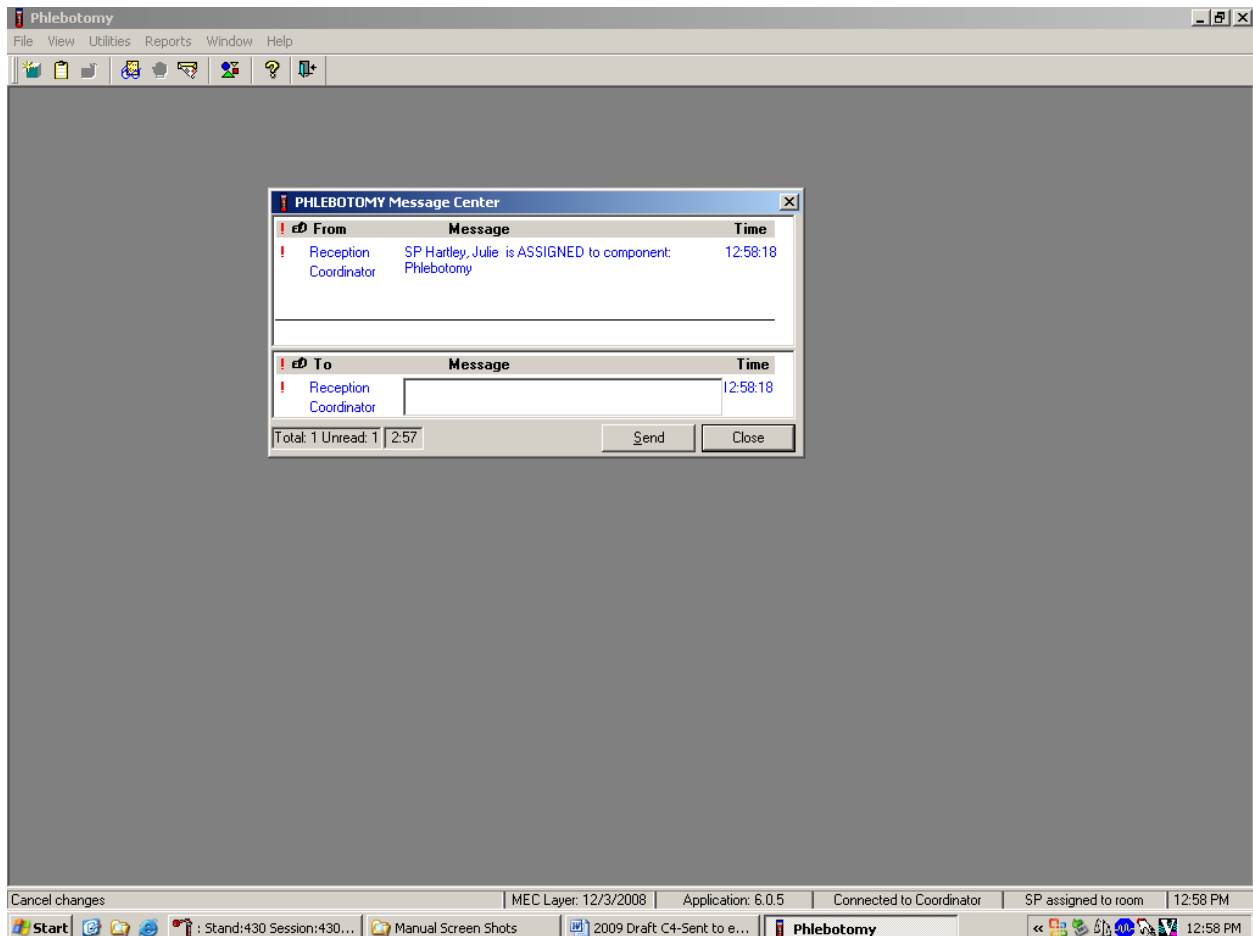

A Message Center message text box displays containing a message from the coordinator indicating the name of the SP who is assigned to the phlebotomy component. Enter an optional text message and, to send the message to the coordinator, direct the mouse arrow to the Send button and left-click. To exit without sending a message to the coordinator, direct the mouse arrow to the Close button and left-click, or press Enter.

Open the Phlebotomy exam.

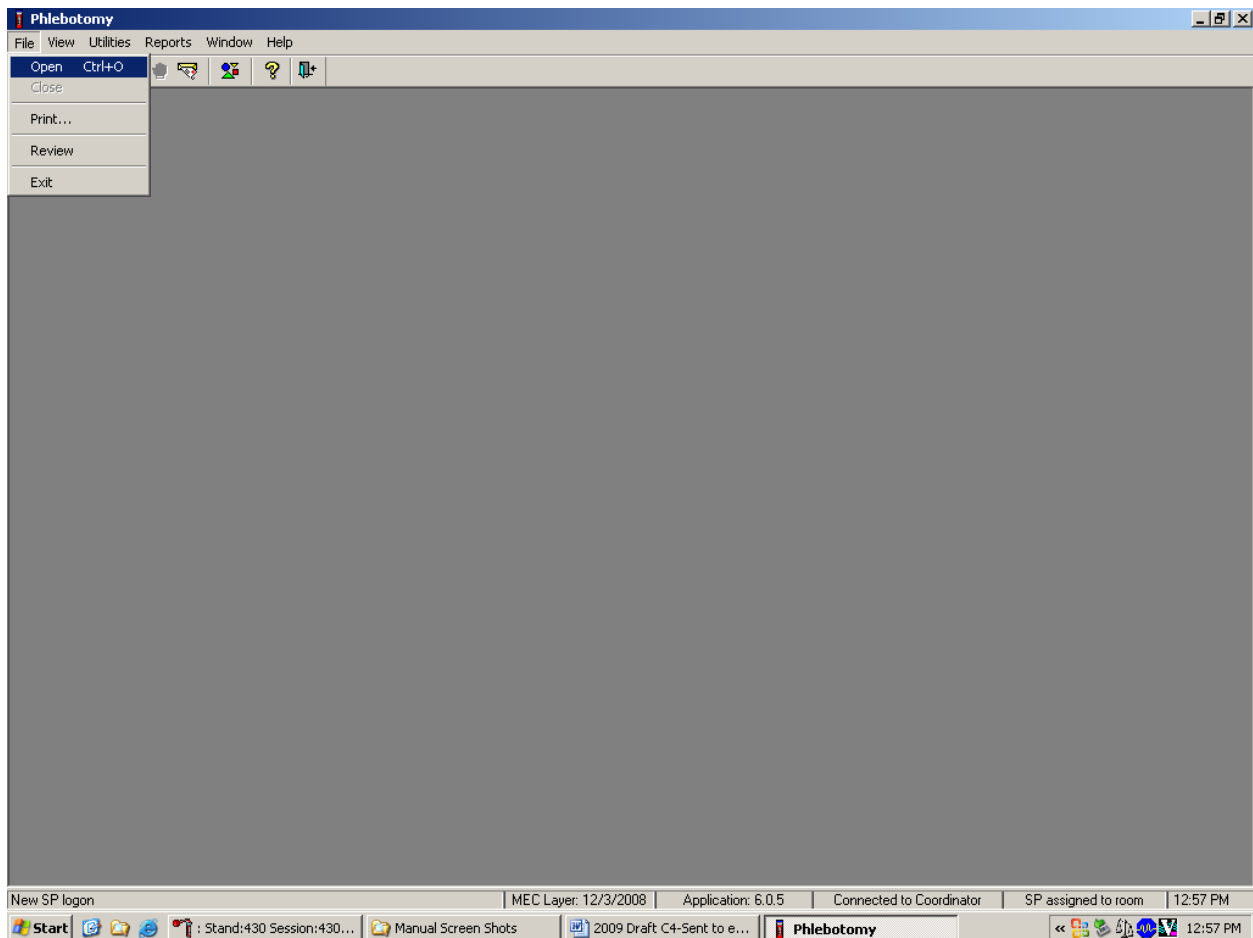

To open an exam, move the mouse to File in the menu bar, click on Open.

The SP Logon window displays.

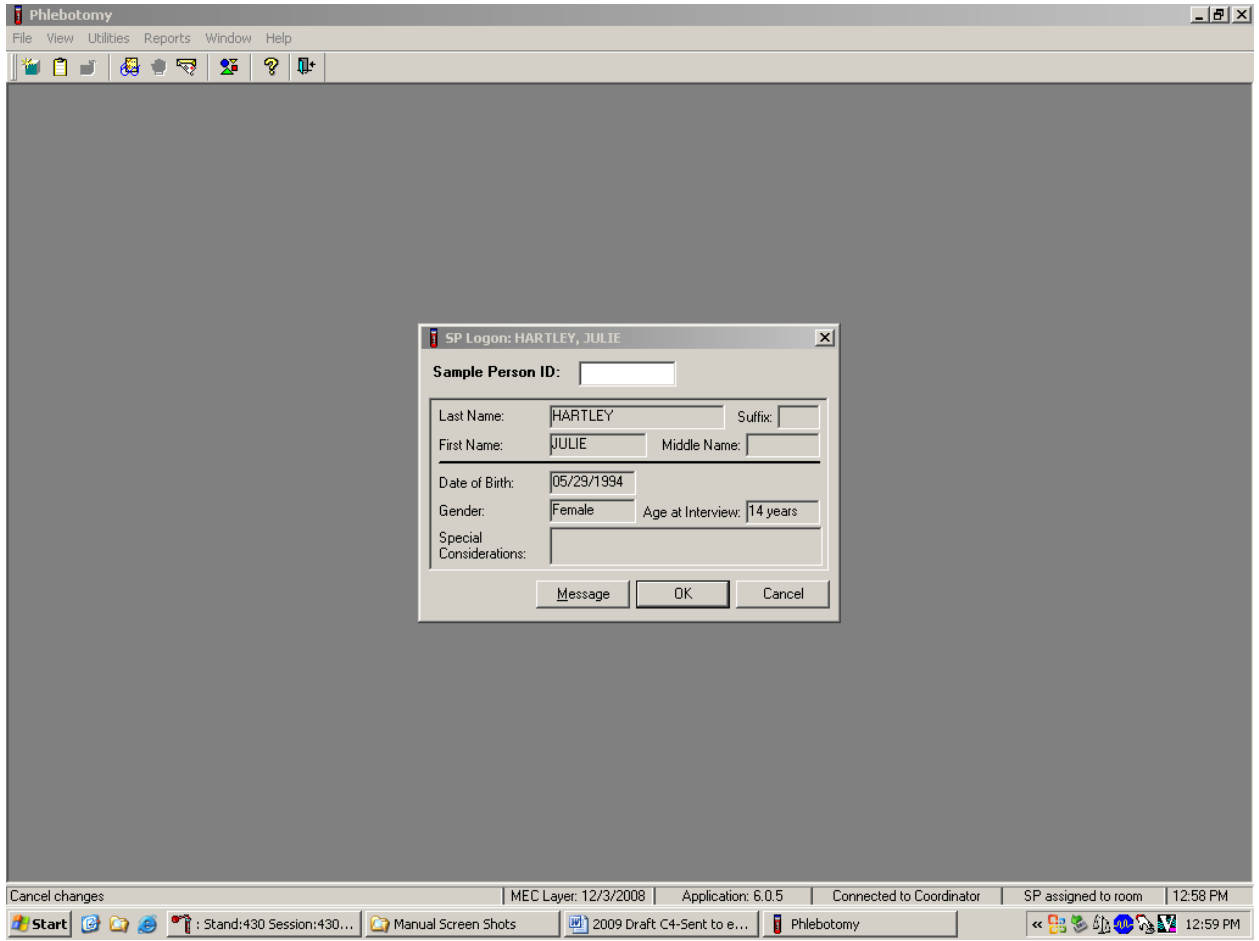

The SP Logon window displays for the SP assigned to the component.

Log the SP into the component.

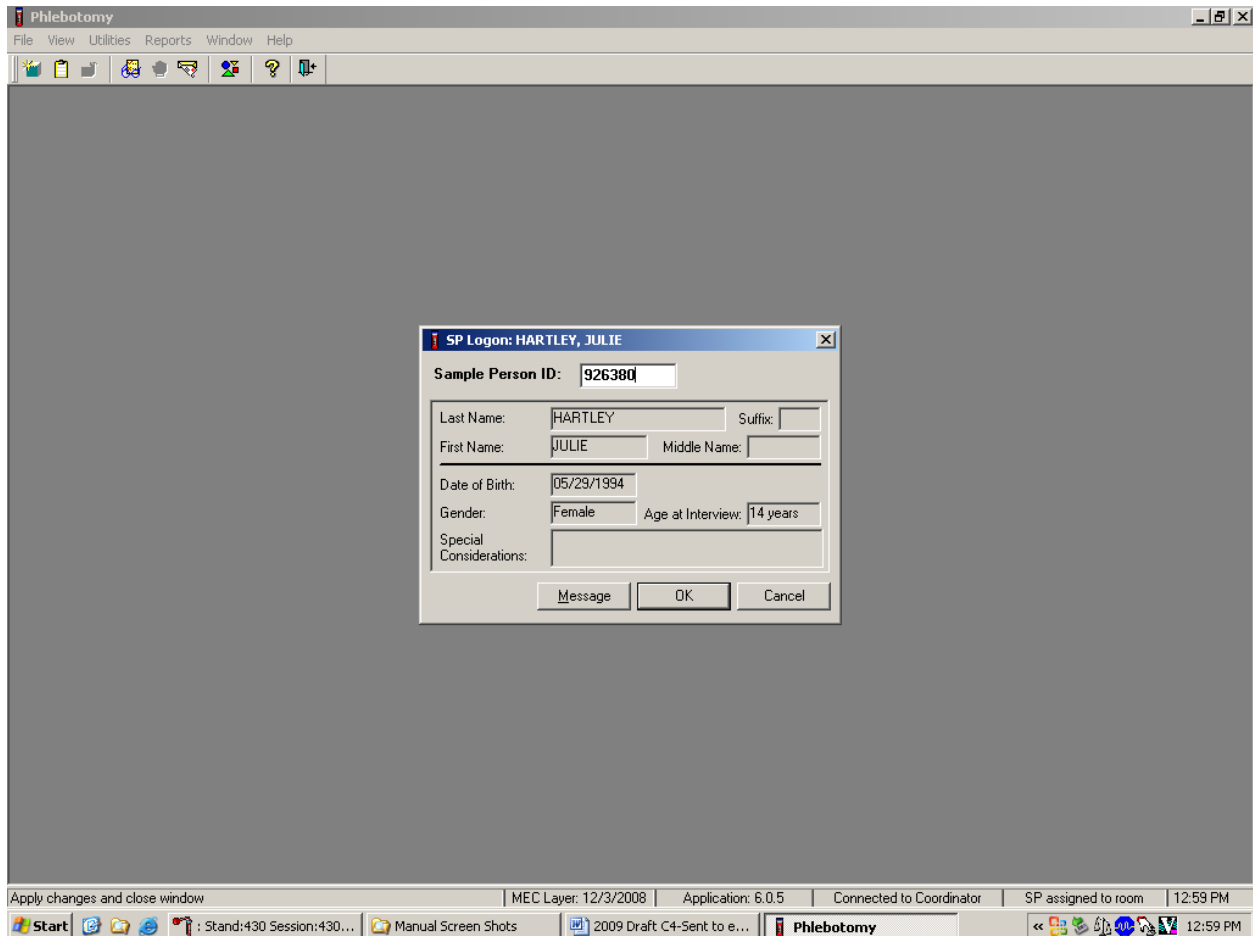

To log the SP into the component, use the barcode wand to scan the bracelet barcode. Otherwise, the phlebotomist can read the SP ID from the SP's bracelet and manually type this number into the Sample Person ID text box. To continue, press Enter or direct the mouse arrow to the OK button and left-click. To cancel the Logon process and to remove the window, direct the mouse arrow to the Cancel button and left-click.

Verify all information that appears in the SP Logon window. If there is an error in any of this information, inform the coordinator immediately. The coordinator will verify and correct the information as necessary.

3.7 The Phlebotomy Interview

The Phlebotomy Interview screen includes a shared exclusion pregnancy question for all females aged 12-59 years and younger if the SP has reported starting her menses, plus two safety exclusion questions. There are only two reasons to exclude an SP from venipuncture—hemophilia, and having received chemotherapy within the past 4 weeks. Administer the interview (and fasting questionnaire) directly to SPs over the age of 12, or administer the interview questions (and fasting questionnaire) to the SP’s parent or guardian for SPs under age 12.

Administer the phlebotomy interview immediately before performing the venipuncture. Read the text exactly and record the responses.

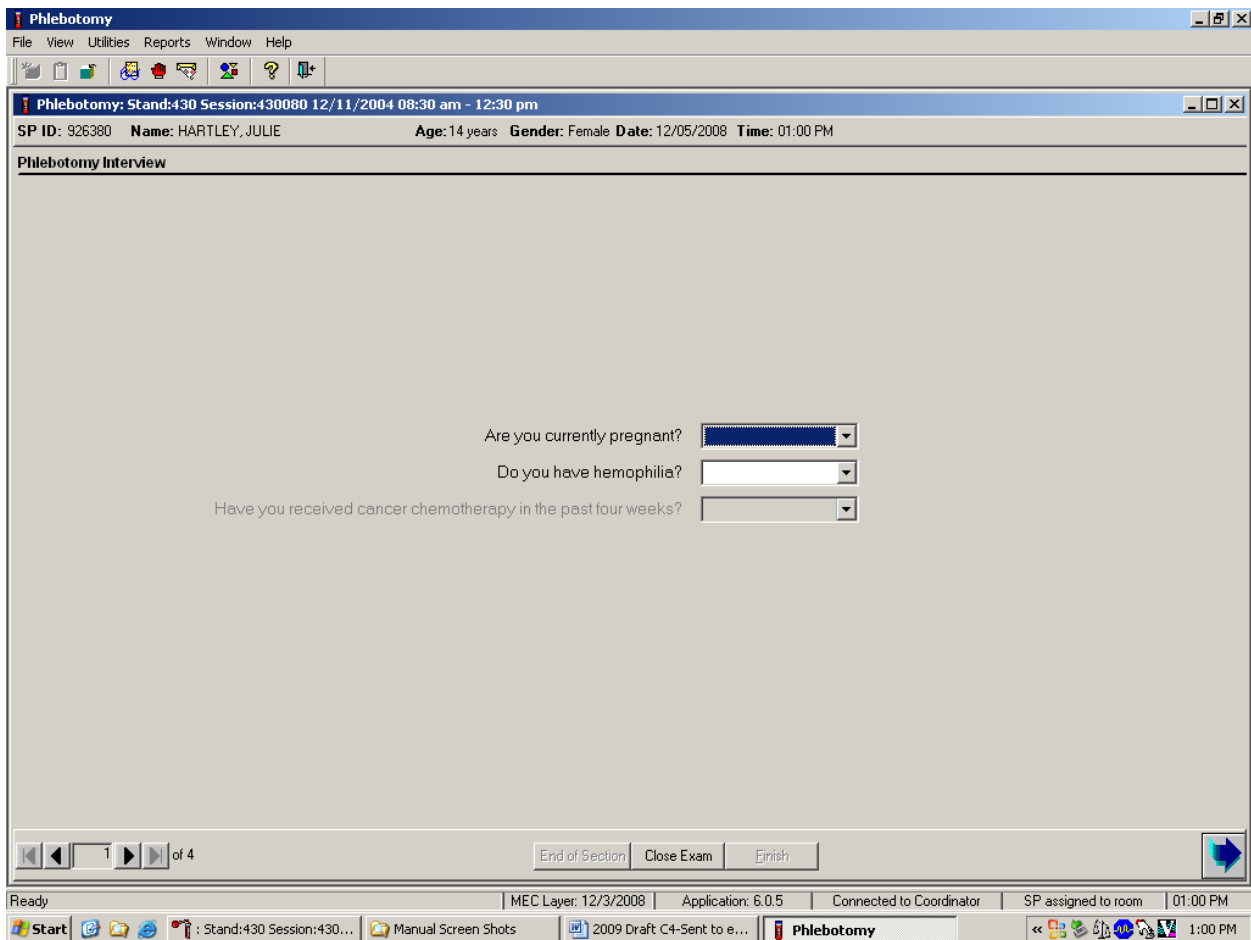

3.7.1 Pregnancy Shared Exclusion Question

For female SPs aged 12-59 years, the shared exclusion pregnancy questions are enabled and are asked during the MEC examination in the first examination. Each question is asked only once, even when the question is relevant for more than one component. Some examinations, like phlebotomy, do not require all the shared exclusions to be asked. In this situation, there may be some questions answered in one examination and then disabled in the remaining examinations. Shared exclusion questions are component specific. Answers provided during previous components appear on the screen for the next examiner to see, but the text box for data entry is disabled. Only shared exclusion questions relevant to the age and component that have not been answered are enabled. Example: If the SP goes to the physician component before phlebotomy, the questions about “pregnancy” and “how many weeks” would be asked by the physician. The “pregnancy” question would be disabled in the phlebotomy component.

- If the SP is a male, a female less than 12 years, or a female older than 60 years, the shared exclusion pregnancy questions will not be displayed, unless a younger female has self-reported that her menses has started.
- If the SP is a female aged 12-59 years, the first shared exclusion pregnancy question is displayed and enabled.

Record the response to the shared exclusion question.

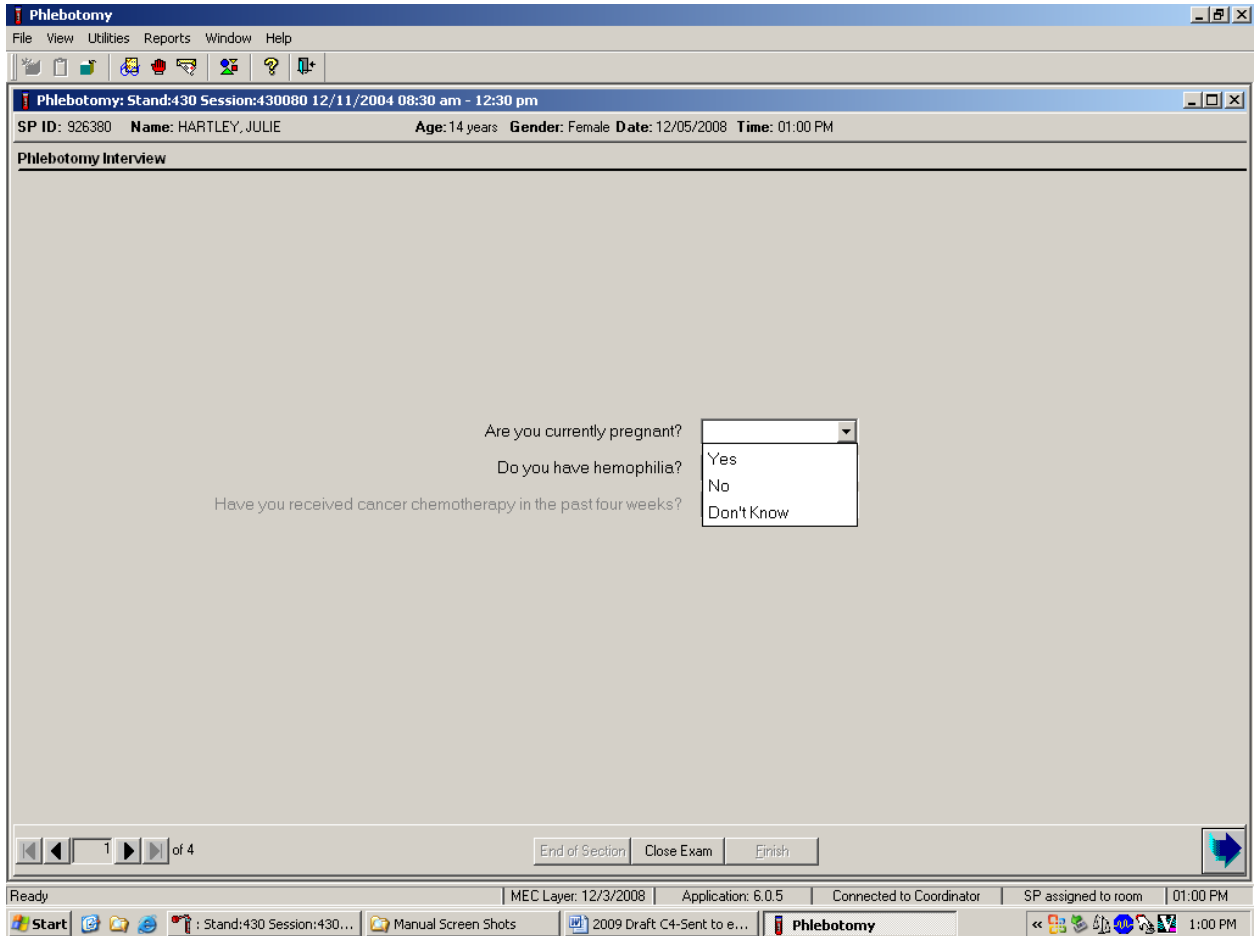

Record the response by typing [Y] for “Yes,” [N] for “No,” or [D] for “Don’t know.” Alternatively, move the mouse to the drop-down arrow on the drop-down list, and drag the mouse arrow to “Yes,” “No,” or “Don’t know” and left-click. Press Tab to move to the next text box.

If the response to the question “Are you currently pregnant?” is “Yes,” the SP is excluded from Liver Ultrasound Transient Elastography and DEXA (Body Composition) due to pregnancy status. At the coordinator application, the component status for Liver Ultrasound Transient Elastography and DEXA defaults to “Not Done” with the comment “Blocked: Not Done [SP pregnant].”

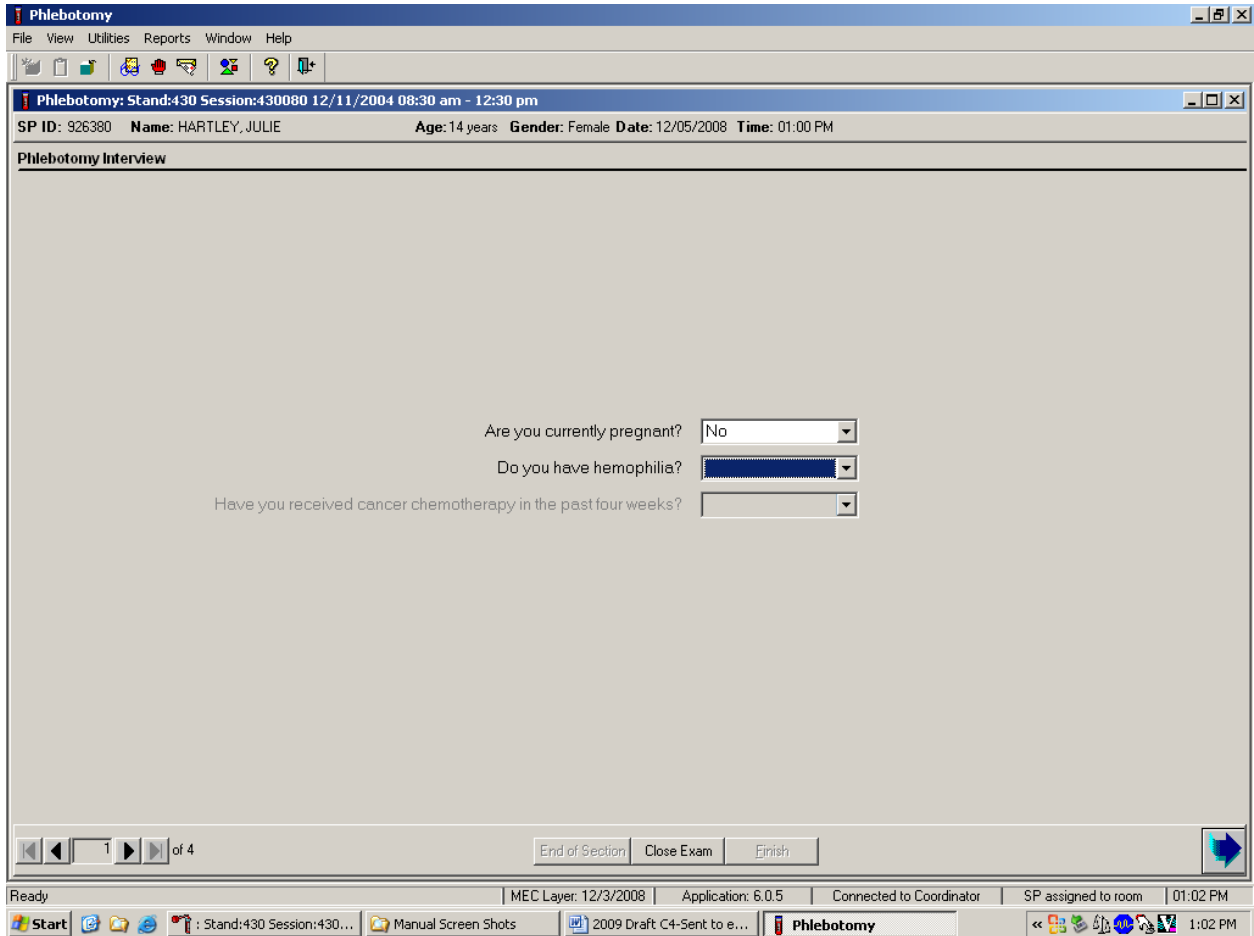

If the answer to the shared exclusion pregnancy question is “No” or “Don’t know,” then press Tab to proceed to the first safety exclusion question, “Do you have hemophilia?”

3.7.2 Safety Exclusion Questions

Continue to conduct the phlebotomy interview by asking the question displayed on the screen, “Do you have hemophilia?”

Q1: Do you have hemophilia?

<p>Q1: This question asks whether the SP has hemophilia, which is an exclusion criterion for this procedure.</p>	<p>Explain that we cannot perform phlebotomy on participants who have hemophilia. Hemophilia is a rare disease where an individual’s blood does not clot normally. If an SP’s relative has hemophilia but the SP does not, the SP is not excluded. If the SP is excluded, the Blood Draw Exclusion box displays. Read the text in the box to the SP and escort the SP back to the coordinator station.</p>
--	--

Record the exact response.

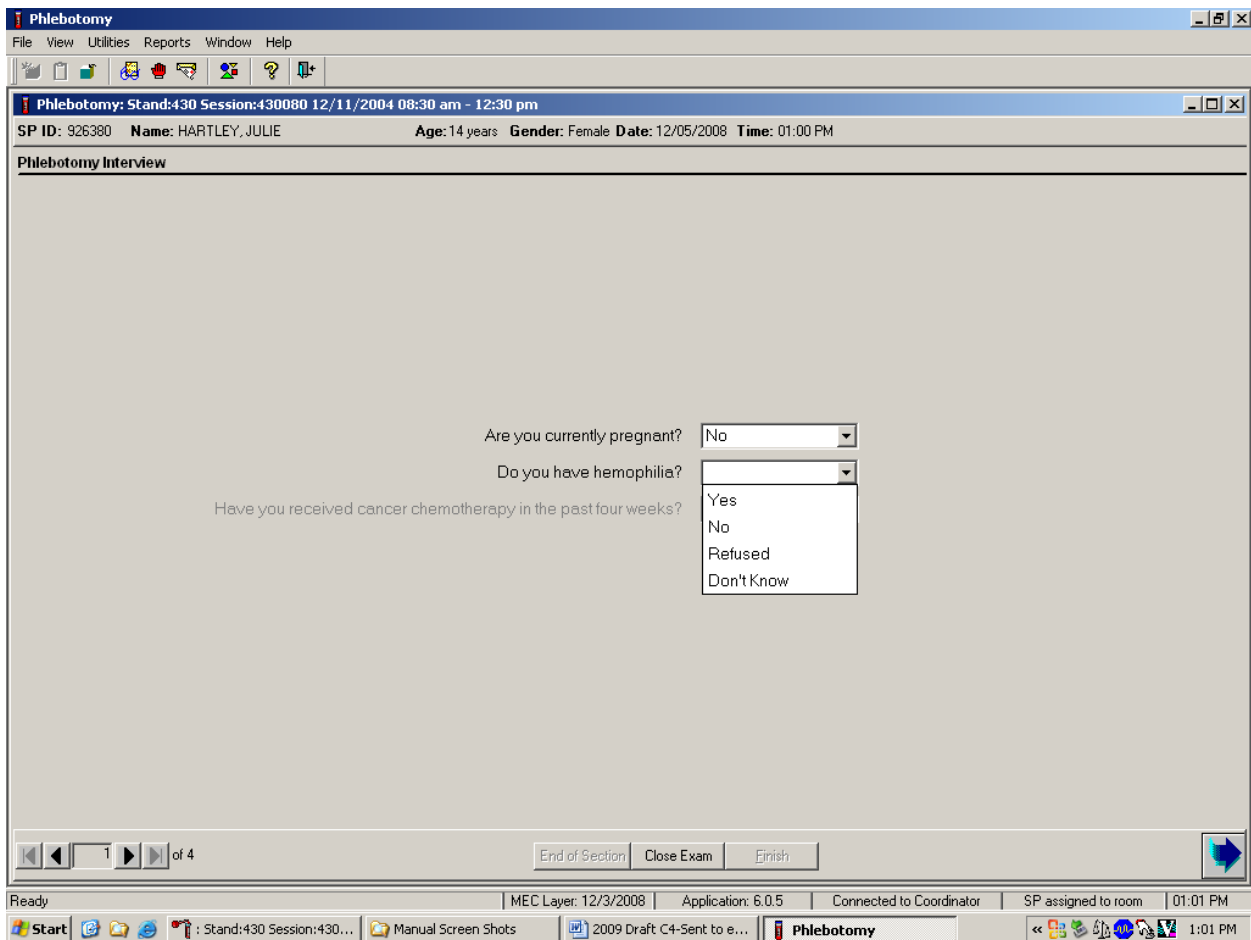

Record the response by typing [Y] for “Yes,” [N] for “No,” [R] if he or she refuses, or [D] for “Don’t know.” Alternatively, move the mouse to the drop-down arrow on the drop-down list, click to display the responses, and drag the mouse arrow to “Yes,” “No,” “Refused,” or “Don’t know” and left-click. If the response is “Yes,” “Refused,” or “Don’t know,” direct the mouse arrow to the bright blue right arrow in the bottom right corner of the screen and left-click or press Enter.

If the SP is excluded from the phlebotomy exam due to hemophilia, the Blood Draw Exclusion informational message text box displays.

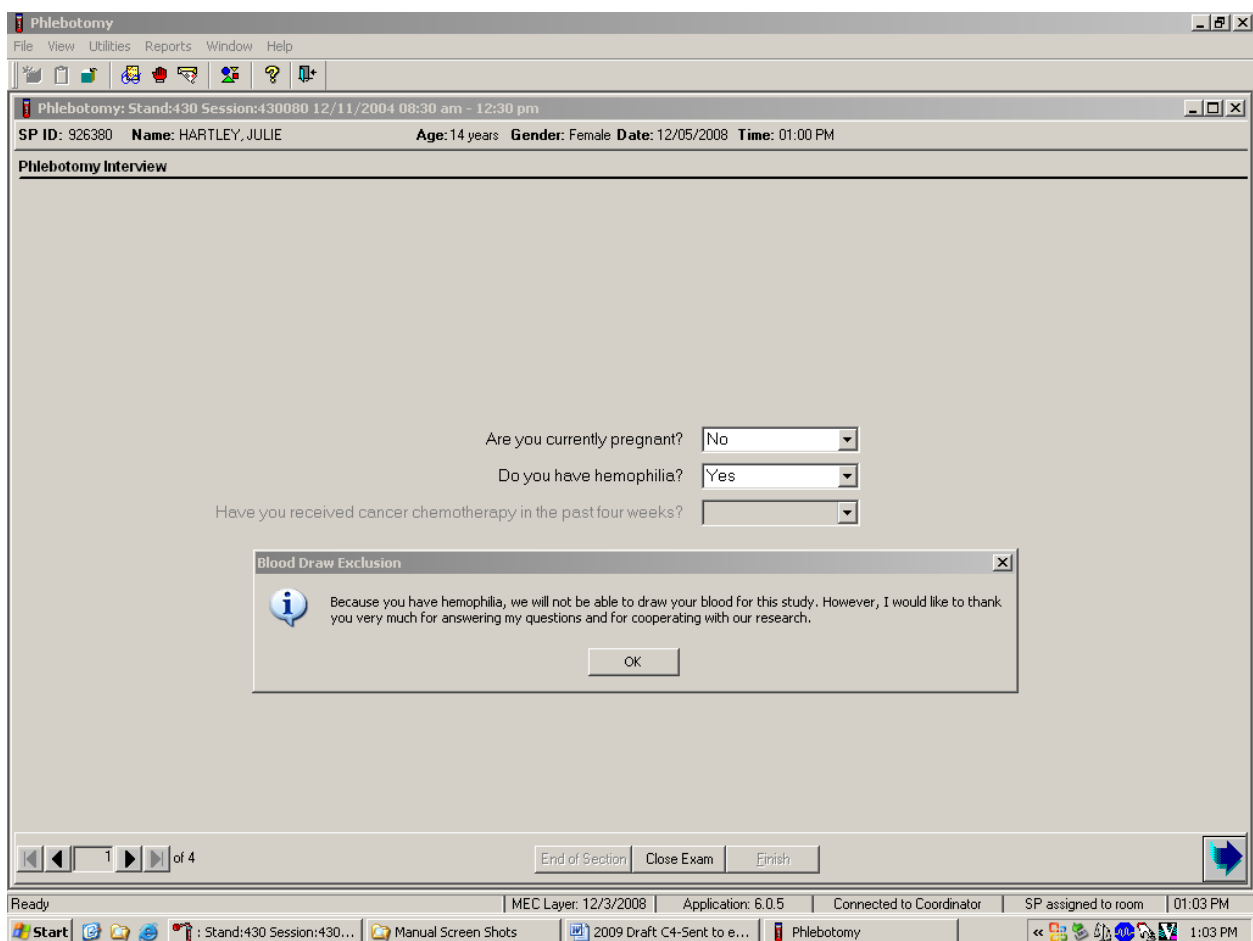

Read the script to the SP. To remove the Blood Draw Exclusion message text box, move the mouse arrow to the OK button and left-click, or press Enter.

If the SP is excluded from the phlebotomy component due to hemophilia, an informational Exclusion message text box displays. In some cases more than one Exclusion message box will display, one after the other.

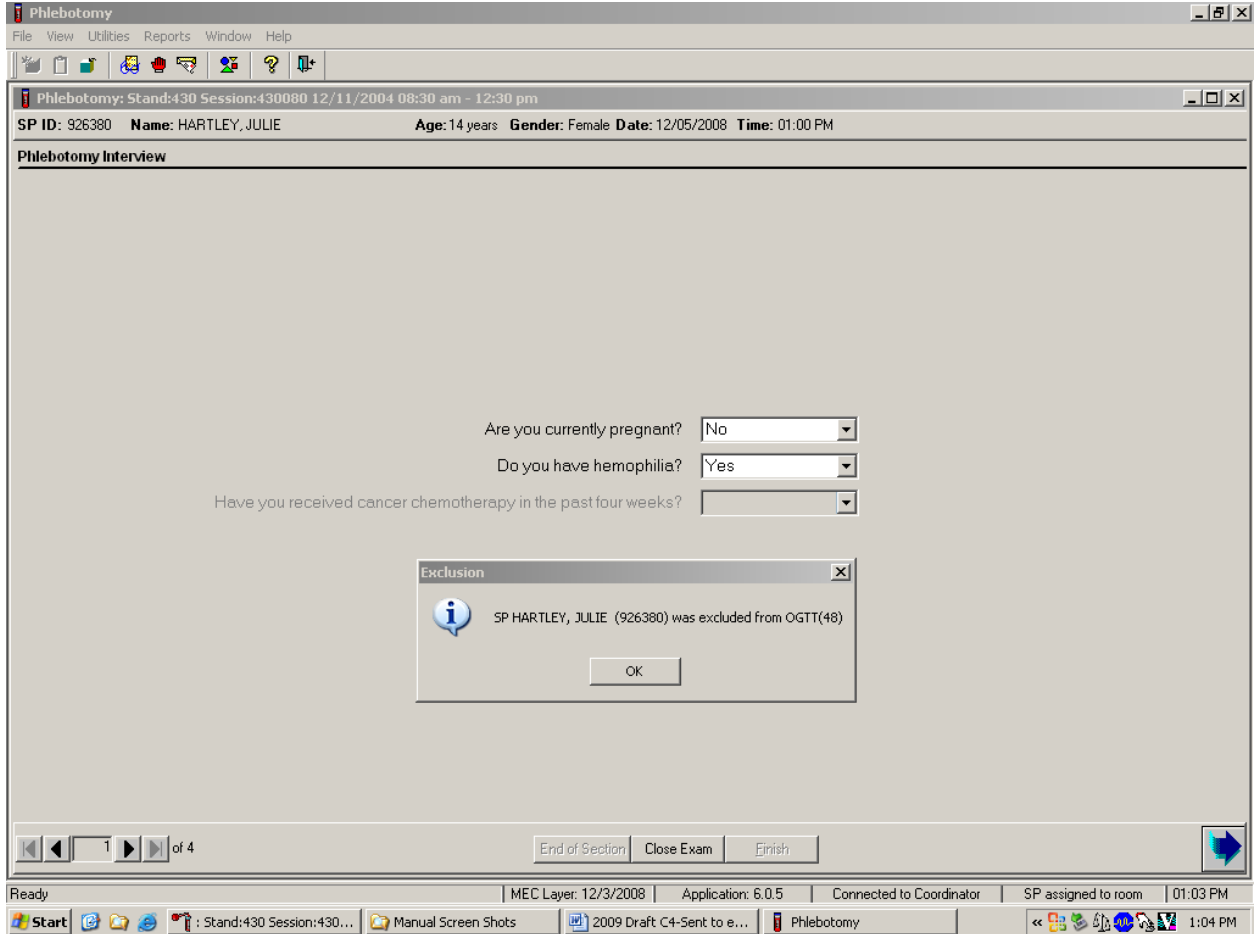

To remove the Exclusion message text box, move the mouse to the OK button and left-click, or press Enter.

Verify the status.

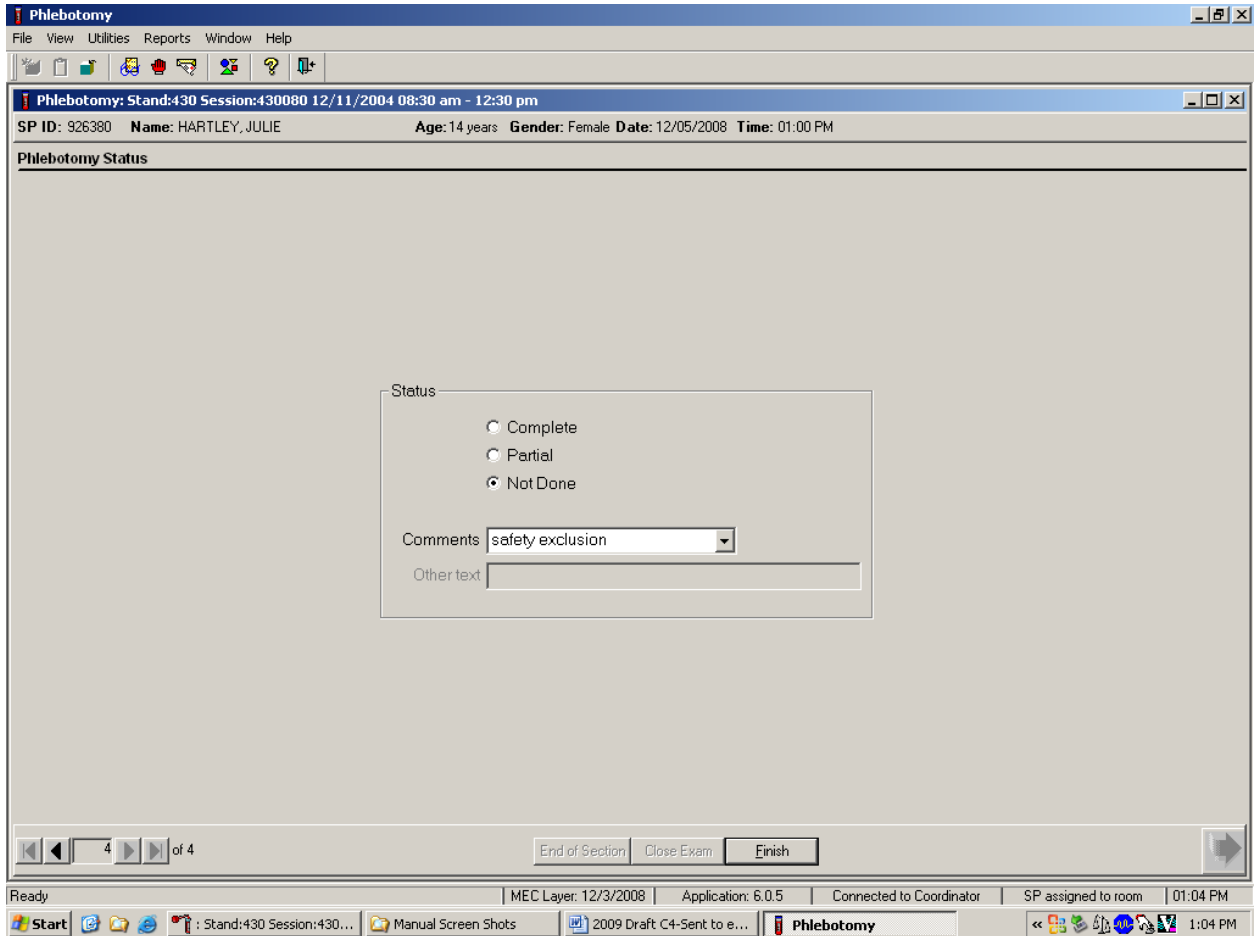

SPs excluded because of hemophilia are automatically coded by the application as a status of “Not Done” with a comment of “safety exclusion.” Escort the SP back to the coordinator or to the next component as directed by the Message Center.

If the SP has not been excluded because of hemophilia, continue the phlebotomy interview by asking the second question displayed on the screen, “Have you received cancer chemotherapy in the past 4 weeks?”

The screenshot shows a software window titled "Phlebotomy" with a menu bar (File, View, Utilities, Reports, Window, Help) and a toolbar. The main window displays patient information: "Phlebotomy: Stand:430 Session:430080 12/11/2004 08:30 am - 12:30 pm", "SP ID: 926380 Name: HARTLEY, JULIE", "Age: 14 years Gender: Female Date: 12/05/2008 Time: 01:00 PM". Below this is a section titled "Phlebotomy Interview". The current question is "Have you received cancer chemotherapy in the past four weeks?" with a dropdown menu open showing options: Yes, No, Refused, and Don't Know. Other questions visible are "Are you currently pregnant?" (No) and "Do you have hemophilia?" (No). At the bottom of the window are navigation buttons: "End of Section", "Close Exam", and "Ejish". The Windows taskbar at the bottom shows the Start button, several open applications, and the system tray with the time 1:05 PM.

Q2: Have you received cancer chemotherapy in the past 4 weeks?

<p>Q2: This question asks whether the SP has received chemotherapy in the past 4 weeks. This situation excludes the SP from this procedure.</p>	<p>Explain that we cannot perform phlebotomy on participants who have received cancer chemotherapy within the past 4 weeks. If the SP is excluded, the Blood Draw Exclusion box is displayed. Read the script in the box to the SP and escort him or her back to the coordinator station.</p>
---	---

Record the response by typing Y for “Yes, N for “No,” R if he or she refuses, or D for “Don’t know.” Alternatively, move the mouse to the drop-down arrow on the drop-down list, click to display the responses, and drag the mouse arrow to “Yes,” “No,” “Refused,” or “Don’t know” and left-click. If the response is “Yes,” “Refused,” or “Don’t know,” direct the mouse arrow to the bright blue right arrow in the bottom right corner of the screen and left-click.

If the SP is excluded from the phlebotomy exam because of cancer chemotherapy, the Blood Draw Exclusion informational message text box displays.

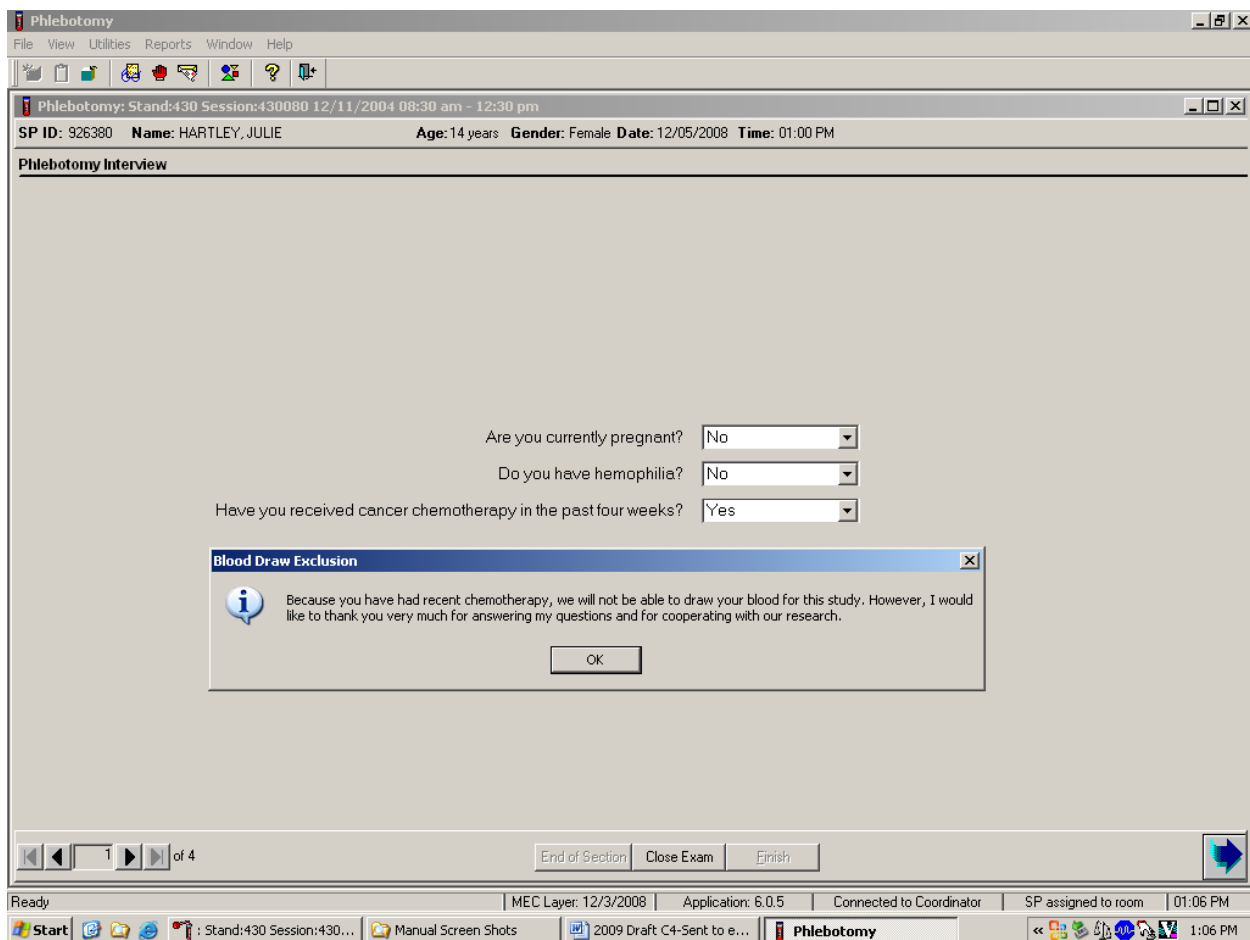

Read the script to the SP. To remove the Blood Draw Exclusion message box, direct the mouse arrow to the OK button and left-click.

If the SP is excluded from the phlebotomy component because of chemotherapy, an informational Exclusion message text box displays. In some cases more than one Exclusion message box will display, one after the other.

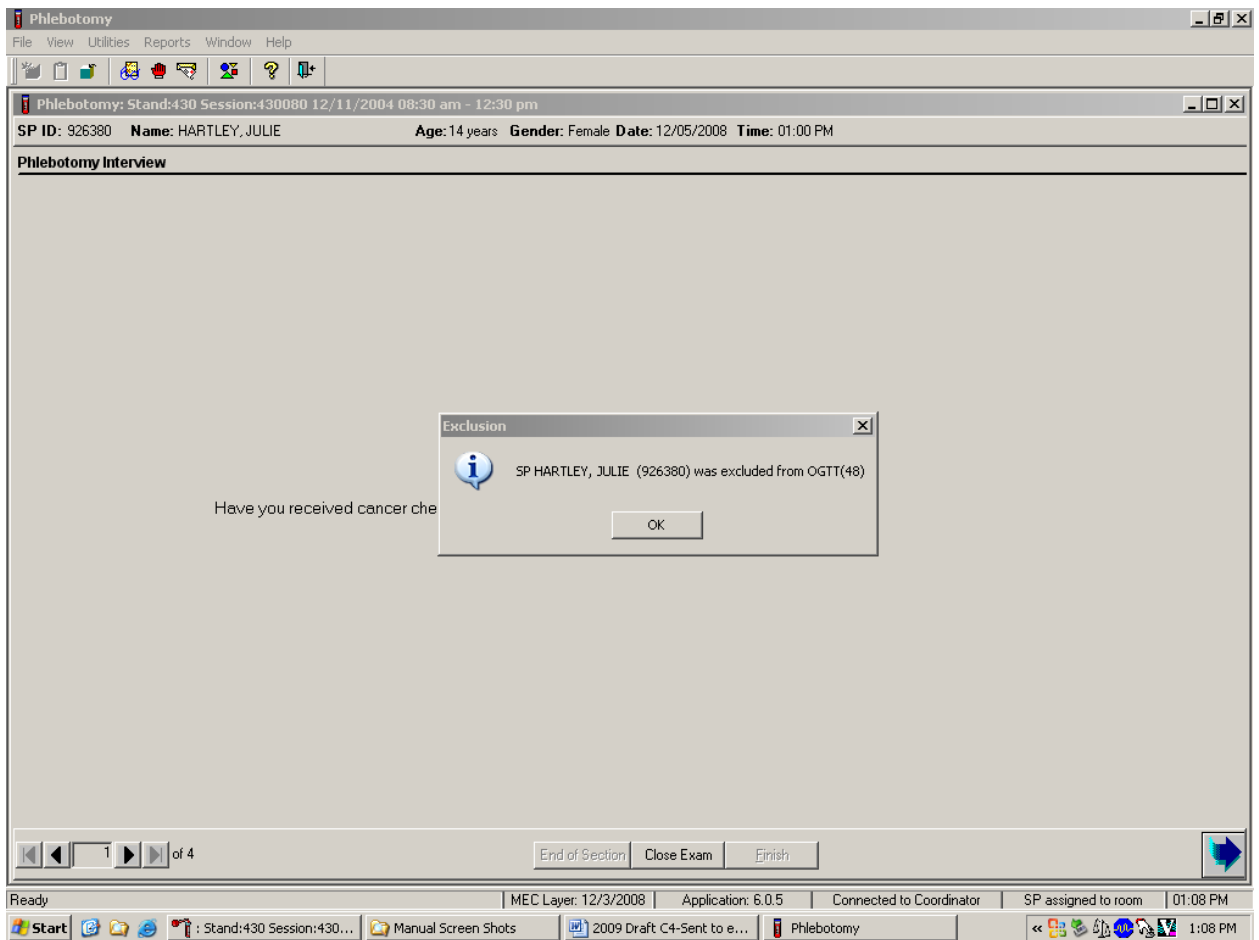

To remove the Exclusion message text box, move the mouse to the OK button and click, or press Enter. To progress to the component status screen, direct the mouse arrow to the bright blue arrow in the bottom right corner and left-click, or press Enter.

Review the status.

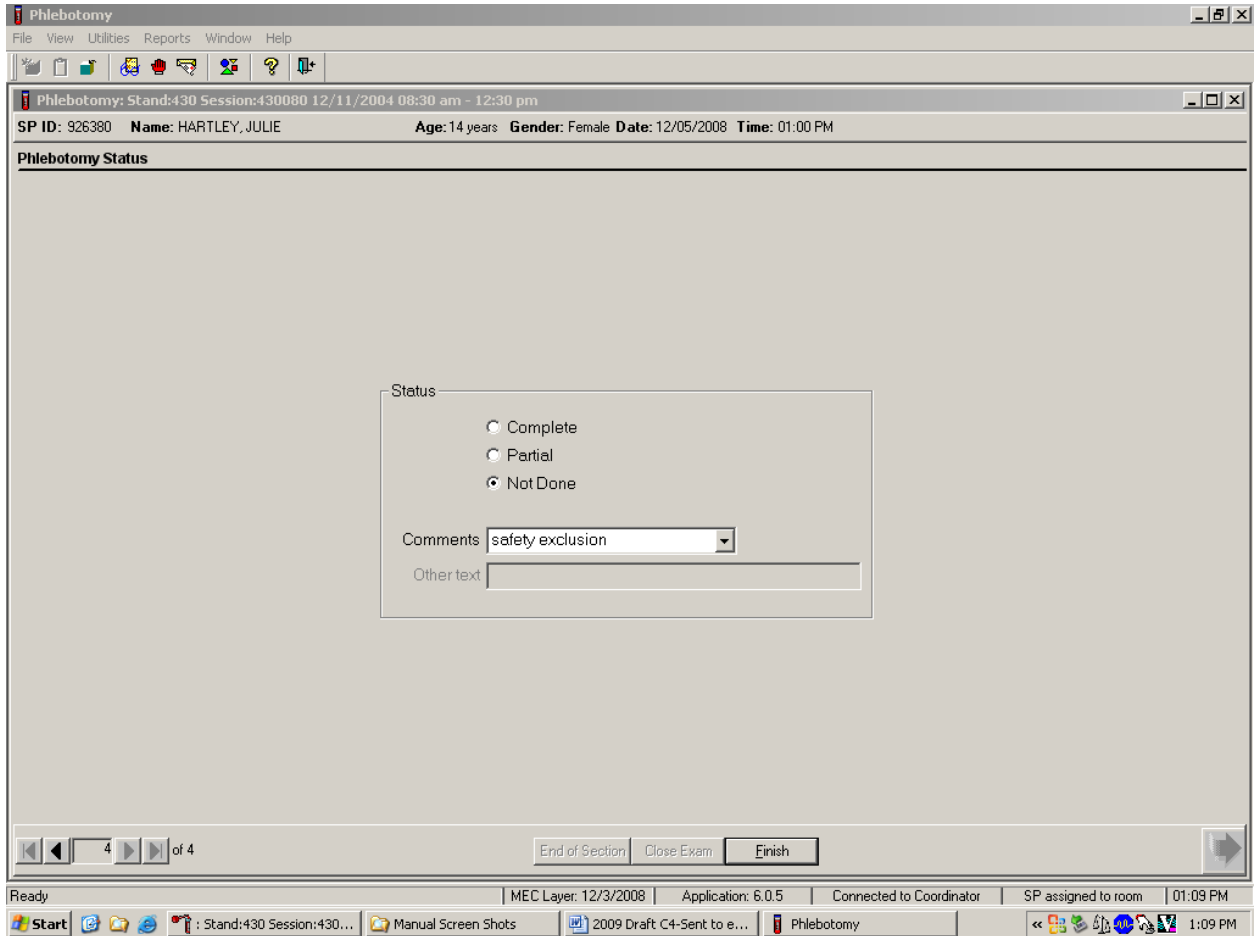

SPs excluded because of chemotherapy are automatically coded by the application as a status of “Not Done” with a comment of “safety exclusion.” Escort the SP back to the coordinator or to the next component as directed by the Message Center.

If the response to both exclusion questions is “No,” continue to the next screen.

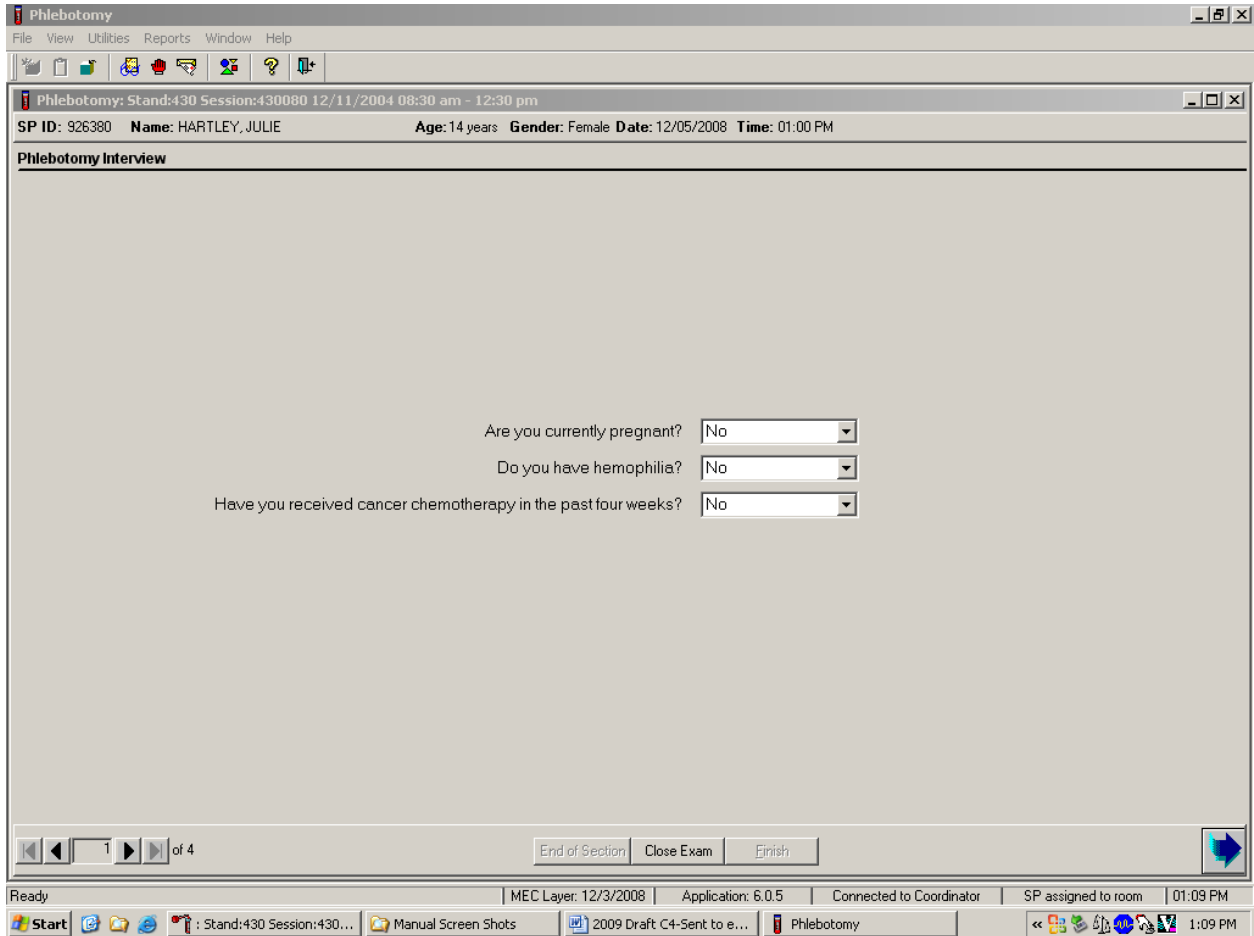

To progress to the fasting questionnaire screen, direct the mouse arrow to the bright blue arrow in the bottom right corner and left-click, or press Enter.

3.8 Administering the Fasting Questionnaire

Fasting status is critical to many of the laboratory analytes, and fasting data are required for correct interpretation of laboratory results. No primary SPs aged 1-11 or SPs assigned to afternoon or evening sessions are asked to fast. All other primary SPs aged 12 years and older appointed to a morning session are asked to fast for 9 hours; this includes diabetics. These SPs are given the highest priority, so the venipuncture can be completed as soon as possible after the SPs checks into the MEC, where they will be offered juice and cookies to be consumed after completion of the Liver Ultrasound Transient Elastography component, if eligible.

The phlebotomist administers the fasting questionnaire to all SPs, and the application calculates and displays the fasting time in number of hours and minutes. The phlebotomist then performs the venipuncture.

The overall objective is to perform phlebotomy on all eligible SPs. The coordinator must base the decision to assign an SP to phlebotomy on the greater goal of completing as many components as possible within the time constraints of the session, with phlebotomy as the highest priority component. Sometimes an SP insists on leaving the MEC before he or she has been assigned to phlebotomy. It is always preferable to get blood from this SP before he or she leaves the MEC. The coordinator and MEC manager can provide the best overall assessment of the status of a particular SP.

Guests do not have a fasting requirement, even during morning sessions.

SPs may opt to return to the MEC to complete exams that were missed or to complete exams that were begun but not finished. These SPs are designated as “Partial” SPs. When the SP returns to the phlebotomy component, ask and record the fasting questions a second time so that the data are accurate. Delete any data in the text boxes (previous responses from the initial visit) and enter the new responses.

Read the text exactly and record the time.

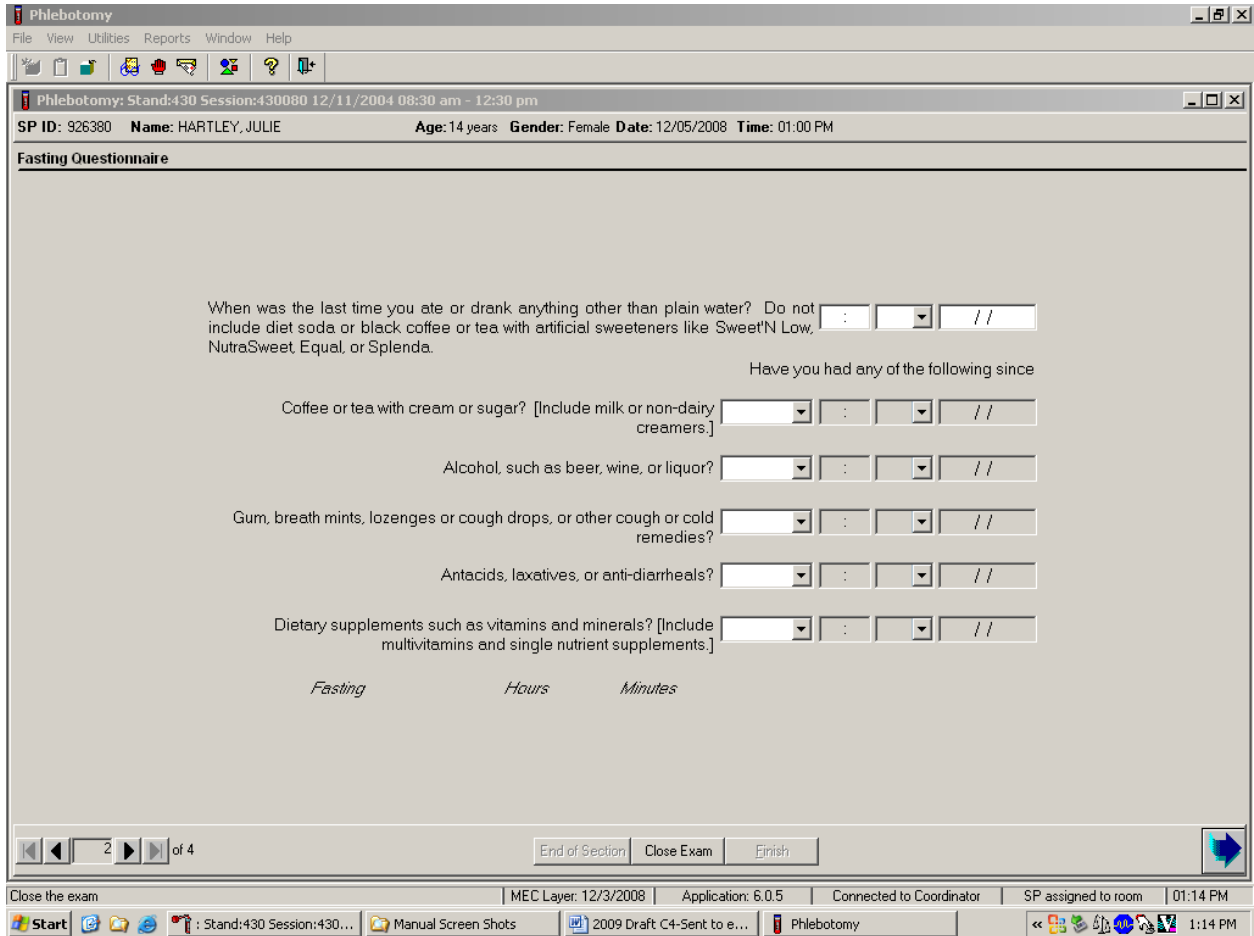

Q1: When was the last time you ate or drank anything other than plain water? Do not include diet soda or black coffee or tea with artificial sweeteners like Sweet'N Low, NutraSweet, Equal, or Splenda.

<p>Q1: This question elicits the last time the SP ate or drank anything and determines fasting time.</p>	<p>SPs are allowed to consume diet soda, black coffee, or tea with artificial sweeteners like Sweet'N Low, NutraSweet, Equal, or Splenda since these have no effect on study analytes. Do not include flavored waters.</p>
--	--

Enter the response.

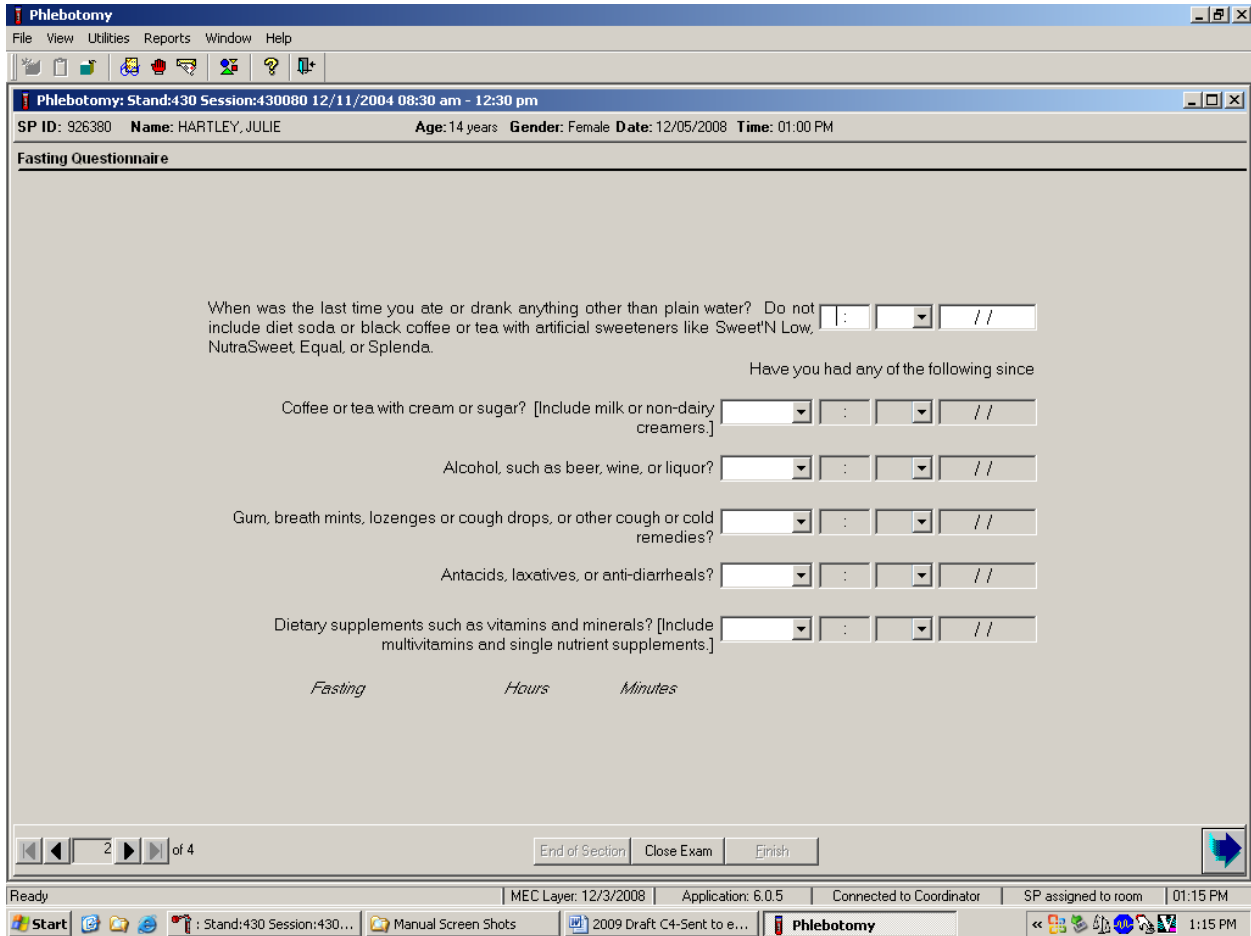

Type in the reported time using the numeric keys and press Tab to move to the AM/PM space. Type in A for times between midnight and 11:59 AM or P for times between 12:00 noon and 11:59 PM and press Tab. Alternatively, to select AM or PM, direct the mouse arrow to the drop-down arrow on the right side of the text box, left-click, drag the mouse arrow to AM or PM and left-click.

Enter the date.

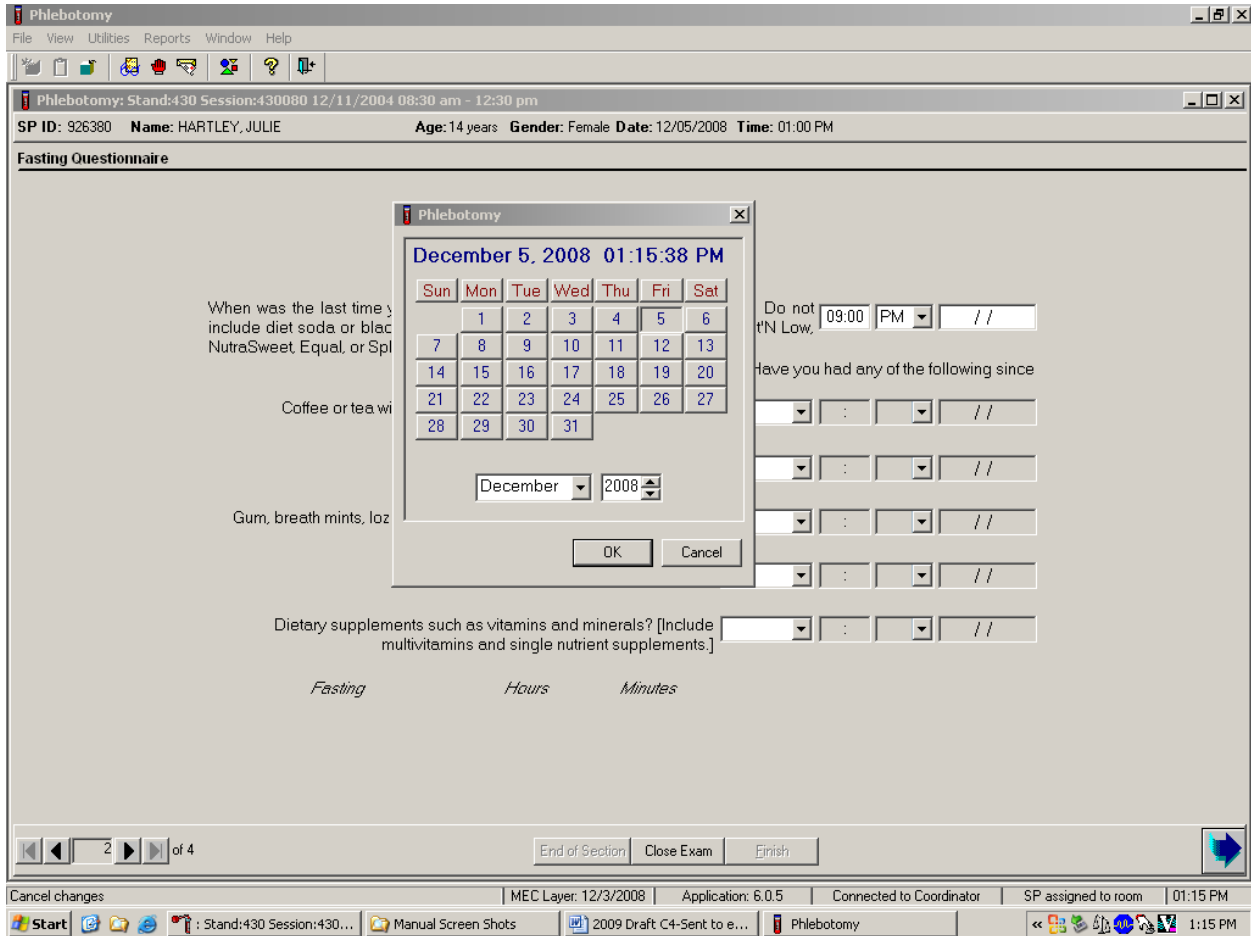

Type in the date using the keyboard’s numeric keys and the mm/dd/yyyy format and press Tab, or use the calendar to enter the date. To access the calendar, select **[F2]**. To select the correct month, direct the mouse arrow to the drop-down list, drag the arrow to the correct month (use the scroll bar if necessary), and left-click. To select the correct day, direct the mouse arrow to the correct day on the displayed month and left-click. To correct the year, direct the mouse arrow to the up-down controls on the spin box and toggle the number up and down. To transfer this date into the date space, direct the mouse arrow to the OK button and left-click, or press Enter. To exit the calendar function, direct the mouse arrow to the Cancel button and left-click.

Continue administering the questionnaire. Verify the initial time response by asking the remaining questions.

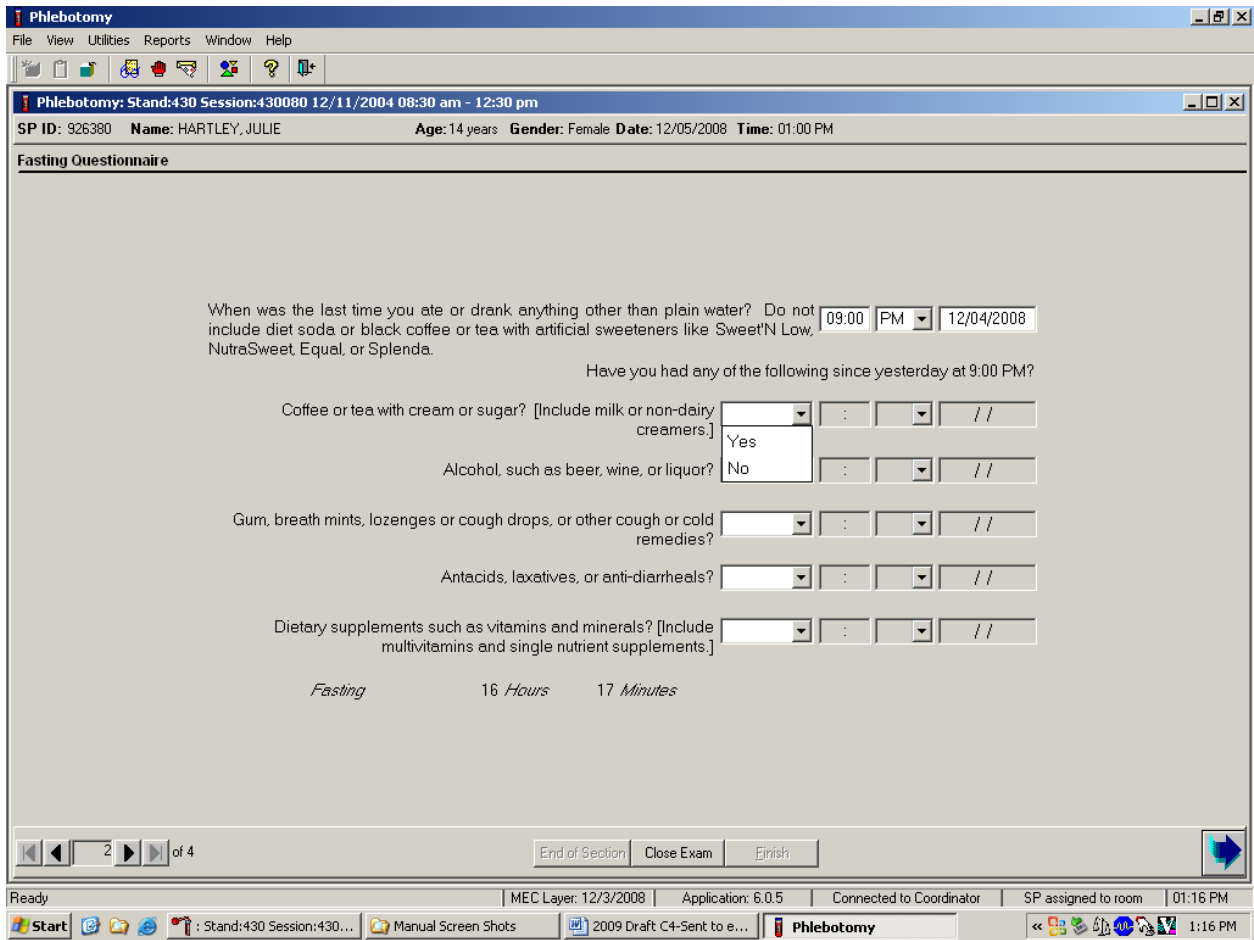

Q2: Have you had any of the following since (time from question 1 inserted here)?

Coffee or tea with cream or sugar? [Include milk or non-dairy creamers.]	Black coffee is acceptable, but coffee with any additives other than artificial sweeteners is unacceptable. Include all milk products such as half-and-half, light cream, nonfat milk, and all other nondairy creamers like Cremora or Coffee-Mate.
Alcohol, such as beer, wine, or liquor?	Alcohol includes all types of spirits including light beer and wine. If the answer is “Yes,” clarify the response. Ask the SP to describe the activity, item consumed, and the correct time.
Gum, breath mints, lozenges, or cough drops, or other cough or cold remedies?	Include sugar-free gum and mints in this category. If the answer is “Yes,” clarify the response. Ask the SP to describe the activity, item consumed, and the correct time.
Antacids, laxatives, or anti-diarrheals?	Antacids neutralize stomach acids. Laxatives stimulate evacuation of the bowels. Anti-diarrheals relieve diarrhea and cramping. Include all over-the-counter antacids, laxatives, and anti-diarrheals. If the answer is “Yes,” clarify the response. Ask the SP to describe the activity, item consumed, and the correct time.
Dietary supplements such as vitamins and minerals? [Include multivitamins and single nutrient supplements.]	Vitamins refer to various relatively complex organic substances occurring naturally in plant and animal tissue. They are essential in small amounts for the control of metabolic processes. Many are available over the counter as multivitamin-multimineral or single-nutrient supplements like Vitamin C. Include all of these when clarifying the response to this question. If the answer is “Yes,” clarify the response. Ask the SP to describe the activity, item consumed, and the correct time.

To enter a “Yes” or “No” response, type [Y/y] for “Yes” and [N/n] for “No.” Use the up and down arrow keys to toggle between the two choices. Alternatively, direct the mouse arrow to the drop-down arrow on the response text box, select “Yes” or “No” and left-click. If “No” is entered, the next response box is highlighted. If “Yes” is entered, the time and date text boxes are highlighted. Type in the reported time using the numeric keys and press Tab to move to the AM/PM space. Type in [A/a] for times between midnight and 11:59 AM or [P/p] for times between 12:00 noon and 11:59 PM and press Tab. Alternatively, to select AM or PM, direct the mouse arrow to the drop-down arrow on the right side of the text box, left-click, drag the mouse arrow to “AM,” or “PM,” and left-click.

Type in the date using the keyboard's numeric keys and the mm/dd/yyyy format and press Tab, or use the calendar to enter the date. To access the calendar, select [F2]. To select the correct month, direct the mouse arrow to the drop-down list, drag the arrow to the correct month (use the scroll bar if necessary), and left-click. To select the correct day, direct the mouse arrow to the correct day on the displayed month and left-click. To correct the year, direct the mouse arrow to the up-down controls on the spin box and toggle the number up and down. To transfer this date into the date space, direct the mouse arrow to the OK button and left-click, or press Enter. To exit the calendar function, direct the mouse arrow to the Cancel button and left-click.

Example of Changing the SP's Fasting Time

When administering the questions in the questionnaire, there will be instances that trigger the SP's memory, and the phlebotomist will need to go back and change the fasting time.

Phlebotomy

File View Utilities Reports Window Help

Phlebotomy: Stand-430 Session:4300000 12/11/2004 09:30 am - 12:30 pm

SP ID: 926380 Name: HARTLEY, JULIE Age: 14 years Gender: Female Date: 12/05/2008 Time: 01:00 PM

Fasting Questionnaire

When was the last time you ate or drank anything other than plain water? Do not include diet soda or black coffee or tea with artificial sweeteners like SweetN Low, NutraSweet, Equal, or Splenda. [: :] [/ /]

Have you had any of the following since

Coffee or tea with cream or sugar? [Include milk or non-dairy creamers.] [: :] [/ /]

Alcohol, such as beer, wine, or liquor? [: :] [/ /]

Gum, breath mints, lozenges or cough drops, or other cough or cold remedies? [: :] [/ /]

Antacids, laxatives, or anti-diartheals? [: :] [/ /]

Dietary supplements such as vitamins and minerals? [Include multivitamins and single nutrient supplements.] [: :] [/ /]

Fasting Hours Minutes

End of Section Close Exam Finish

Close the exam MEC Layer: 12/3/2008 Application: 6.0.5 Connected to Coordinator SP assigned to room 01:14 PM

Start Stand-430 Session:430... Manual Screen Shots 2009 Draft C4-Sent to e... Phlebotomy 1:14 PM

For the SP who had coffee with cream and sugar, this question should have been changed to the time when she drank the coffee with cream and sugar.

The **first question determines the SP's fasting time** and the next 5 questions are to help trigger the SP's memory.

Reason to adjust the fasting time:

- If the SP says yes to the coffee with cream or sugar – change the time in the 1st question to reflect this.
- If the SP had alcohol – change the time in the first question to reflect this.
- If the SP has had gum, breath mints, lozenges or cough drops (unless they were sugar free) – change the time in the first question to reflect this.

Review the data in the Fasting Questionnaire.

Phlebotomy

File View Utilities Reports Window Help

Phlebotomy: Stand:430 Session:430080 12/11/2004 08:30 am - 12:30 pm

SP ID: 926380 Name: HARTLEY, JULIE Age: 14 years Gender: Female Date: 12/05/2008 Time: 01:00 PM

Fasting Questionnaire

When was the last time you ate or drank anything other than plain water? Do not include diet soda or black coffee or tea with artificial sweeteners like Sweet'N Low, NutraSweet, Equal, or Splenda. 09:00 PM 12/04/2008

Have you had any of the following since yesterday at 9:00 PM?

Coffee or tea with cream or sugar? [Include milk or non-dairy creamers.] No : //

Alcohol, such as beer, wine, or liquor? No : //

Gum, breath mints, lozenges or cough drops, or other cough or cold remedies? No : //

Antacids, laxatives, or anti-diarrheals? No : //

Dietary supplements such as vitamins and minerals? [Include multivitamins and single nutrient supplements.] Yes 08:00 AM 12/05/2008

Fasting 16 Hours 17 Minutes

2 of 4

End of Section Close Exam Finish

Ready MEC Layer: 12/3/2008 Application: 6.0.5 Connected to Coordinator SP assigned to room 01:17 PM

Start : Stand:430 Session:430... Manual Screen Shots 2009 Draft: C4-Sent to e... Phlebotomy 1:17 PM

To progress to the next screen, direct the mouse arrow to the bright blue arrow in the bottom right corner and left-click, or press Enter.

SPs Not Meeting 9-Hour Fast – Morning Session Only

A system was implemented to ensure that SPs who would meet their 9-hour fast would wait until they met their fast to have their first venipuncture. The coordinator screen will turn yellow and the phlebotomy application would give a message “I will need to have you wait until approximately (time) before I can collect your blood. I will have the coordinator bring you here at the right time.” When the SP has met the 9-hour fast, the coordinator screen will turn green, which indicates the SP has met the fast and can return to phlebotomy.

The screenshot shows a software application window titled "Phlebotomy: Stand:430 Session:430040 12/07/2004 08:30 am - 12:30 pm". The window contains a "Fasting Questionnaire" form. The form includes the following fields and options:

- When was the last time you ate or drank anything other than plain water? Do not include diet soda or black coffee or tea with artificial sweeteners like Sweet'N Low, NutraSweet, Equal, or Splenda. (Time: 12:10 AM, Date: 11/06/2009)
- Have you had any of the following since today at 12:10 AM?
 - Coffee or tea with cream or sugar? (Include milk or non-dairy) []
 - Alcohol []
 - Antacids, laxatives, or anti-diarrheals? [No]
 - Dietary supplements such as vitamins and minerals? [Include multivitamins and single nutrient supplements.] [No]
- Fasting: 8 Hours 47 Minutes

A pop-up message box titled "Return for blood draw" is overlaid on the form. The message reads: "I will need to have you wait until approximately 09:10 AM before I can collect your blood. I will have the Coordinator bring you back here at the right time." The message box has an "OK" button.

The phlebotomy status screen will automatically default to Not Done with a comment of “Waiting to meet fast.”

Stand:430 Session:430040 12/07/2004 08:30 am - 12:30 pm

File View Utilities Reports Window Help

Phlebotomy: Stand:430 Session:430040 12/07/2004 08:30 am - 12:30 pm

SP ID: 973550 Name: WEAVER_1,JOE Age: 43 years Gender: Male Date: 11/06/2009 Time: 08:56 AM

Phlebotomy Status

Status

Complete

Partial

Not Done

Comments Waiting to meet fast

Other text

If the SP will never meet the 9-hour fast during the session, he or she is prompted to have his or her blood drawn at that time without waiting. If the 9-hour fast will not be met by 12:30, the application will allow the blood to be drawn in the phlebotomy exam.

NOTE: The system does not know if the SP is leaving early. The blood should be drawn if the SP hasn't met his or her 9-hour fast and needs to leave the mobile examination center (MEC). (The coordinator will need to drag the SP's name into the phlebotomy room on the coordinator screen).

3.9 Venipuncture Procedures

Venipuncture should generally be performed using the median cubital, cephalic, or basilic veins in the left arm unless this arm is unsuitable. If the veins in the left arm are unsuitable, look for suitable veins in the right arm. If the veins in the antecubital space on both arms are not suitable, then look

for veins in the forearm or dorsal side of the hand on the left arm/hand and then the right arm/hand.

The Vacutainer system of blood collection consists of glass or plastic tubes with color-coded stoppers containing a premeasured vacuum that provides a controlled draw. Some tubes may contain additives to prohibit coagulation or inhibit glycolysis of blood cells. Draw the tubes in the order designated by the venipuncture protocol.

The exact quantity of blood drawn into each tube varies slightly with altitude, ambient temperature, and venous pressure. Fill tubes with additives completely to ensure proper ratio of blood to additive. Thoroughly mix the lavender tubes, 2-ml and 7-ml gray-top tubes immediately after drawing the blood. Visually check the bottom of the 7 ml gray top tube to ensure all the powder has been dissolved. Remix as appropriate. Label all the blood tubes and place them in the pass-through window to the laboratory.

Use Vacutainer tubes at room temperature. Protect tubes from extreme temperatures and store in a cool place. Note the expiration date printed on Vacutainer tubes. Do not use expired tubes unless they are the only tubes available and they still contain a vacuum. Indicate if using expired tubes by using the “Other, specify” comment option on the venipuncture status screen. Document the use of any expired tubes in a Unusual Field Occurrence (UFO).

Allow two venipuncture attempts with the SP’s verbal consent or with the parent’s consent if an SP is a child or an infant.

If an SP faints or becomes ill, causing termination of the procedure without collecting all of the blood, repeat the procedure with the SP’s consent after the SP has recovered.

3.9.1 Preparation of the Puncture Site

It is extremely important that the anticipated puncture site is thoroughly cleaned and all necessary equipment, including needles and tubes, is kept sterile and free from contamination.

Follow the steps outlined below to prepare the puncture site.

- Place venipuncture equipment where it is readily available but not in danger of being upset. Keep extra equipment within easy reach.
- Thoroughly wash hands.
- Put on gloves.
- Place appropriate blood collection tubes in a test tube rack in the order dictated by the venipuncture protocol. If an SP exhibits nervousness, block the tubes from their view, if possible
- Instruct the SP to sit in the phlebotomy chair. **Never** attempt a venipuncture on a standing subject. Having the subject sit helps guard against any injury that might result if the subject faints. Place the SP in a supine position if it is impossible for him or her to sit upright during the procedure. Instruct the SP to extend the arm palm up and straight at the elbow. If the SP is a child or infant, have a medical technologist hold the SP in the proper position.
- Position the SP's arm on the armrest or a pillow so that the veins are readily accessible and you are able to work in a comfortable position. Be sure that the arm is in a downward position with the elbow lower than the heart to prevent backflow. Change the pillowcase daily.
- Inspect the arm. Use the left arm unless unsuitable. The veins of choice are the cephalic, basilic, and median cubital veins located in the antecubital fossa area.
- If the veins in the antecubital space are not suitable, look for suitable veins on the forearm or on the dorsal side of the hand.
- Apply the tourniquet several inches above the selected site.
- Select a vein that is palpable and well-fixed to surrounding tissue. Palpate even when the vein is visible. Use the following techniques if the veins do not distend quickly.
 1. Warm the antecubital area.
 2. Tap the area lightly with the index and second finger two or three times to cause the veins to dilate.
 3. Allow the arm to hang at the SP's side without a tourniquet to allow the veins to fill to their capacity.
 4. Examine the SP's other arm; sometimes the veins in one arm are larger than in the other.
 5. Check carefully for scar tissue or tendons near the vein.

6. Venipuncture should generally be performed using the median cubital, cephalic, or basilic veins in the left arm unless this arm is unsuitable. If the veins in the left arm are unsuitable, look for suitable veins in the right arm. If the veins in the antecubital space on both arms are not suitable, then look for veins in the forearm or dorsal side of the hand on the left arm/hand and then the right arm/hand.

Apply the tourniquet for no more than 1 minute while searching for a vein and then release the tourniquet for 2 to 3 minutes. Avoid prolonged obstruction of blood flow by the tourniquet because it is uncomfortable for the SP and may alter certain results (e.g., cholesterol).

- Reapply the tourniquet when ready to perform the venipuncture.
- Cleanse the area with an alcohol wipe. Do not touch the side of the alcohol wipe that is in contact with the puncture site. Cleanse the area using a circular motion beginning with a narrow radius and moving outward so as not to cross over the area already cleansed.
- Dry the cleansed area using a 2 x 2-inch gauze pad. The area should be completely dry before performing the venipuncture to reduce the burning sensation caused by alcohol penetrating the skin.
- Determine the correct needle size. Use a 19-, 21-, or 23-gauge butterfly depending on the condition of the SP's veins. The 19-gauge butterfly should be suitable for most SPs. If the SP's veins appear fragile or small, use a 21- or 23-gauge butterfly.

3.9.2 Venipuncture Technique for the Nipro (19-, 21-, and 23-Gauge)

- Prepare the blood collection set. Obtain one blood collection set and one luer adapter. Open the blood collection package and inspect the unit. Open the cover by twisting the two ends at the seal. Push the male luer adapter firmly and securely into the female end of the needle assembly. Attach a tube holder onto the adapter.
- Ask the SP to make a fist. Do not have the SP pump his or her fist since this action may alter certain results.
- Fix the vein about one inch below the proposed point of entry by pulling the skin taut with the thumb of your less dominant hand.
- Approach the vein in the same direction that the vein runs, holding the needle with bevel up and at a 15-degree angle to the SP's arm.
- Remove the needle cover. Grasp the wings and push the needle firmly and deliberately into the vein. Do not grasp the translucent needle shield to insert. If the needle is in the vein, a small amount of blood will appear in the butterfly tubing. Quickly push the first Vacutainer tube down on the needle. If the needle is in the vein, blood will flow freely

into the butterfly tubing. If no blood enters the tube and no bruise is forming, probe the vein until blood begins flowing into the tube. If no blood enters the tube and a bruise is forming, remove the needle. Place gauze squares over the puncture site and apply firm pressure to the puncture site for 3 minutes. Switch to the other arm using a new needle.

- Hold the tube with the tube stopper uppermost and with the tube lower than the needle to prevent backflow through the tube. It is very important to prevent possible backflow because of the possibility of adverse reactions to the SP.
- As the Vacutainer tube is filling, transfer the tube holder to the left (less dominant) hand, leaving the dominant hand free to pick up and change the tubes. If left-handed, do the reverse.
- Fill all tubes completely. Make sure the tube contents do not touch the stopper or the end of the needle during the procedure.
- Immediately invert the lavender and gray tubes to ensure proper mixing of blood and anticoagulant or additive.
- Insert the next tube and push it down gently onto the adapter.
- Because prolonged application causes vasoconstriction, remove the tourniquet after 2 minutes to ensure valid test results. If necessary (that is, if the blood flows more slowly), reapply the tourniquet after 2 minutes. If this is the last tube to fill, loosen the tourniquet when the tube begins filling and remove it as the last tube fills.
- Fill tubes in the proper order, according to the protocol.
- When the last tube has filled, remove the needle in a smooth quick motion. Avoid heavy pressure as the needle is being withdrawn because it may cause the point of the needle to cut the vein. To activate the shielding mechanism, either grab the tubing and hold the needle guard at the end closest to the tubing and pull the tubing until the needle guard locks in place, or hold the needle guard at the end closest to the tubing, grab the wings and slide the wings back until the needle guard locks in place.
- Discard the entire blood collection set, including the needle and adapter, in the Sharps needle disposal unit. Do not recap the needle. Discard tourniquet in trash.

3.9.3 Concluding the Venipuncture

- Place all used needles in a sharps container and dispose of all visibly contaminated waste in a biohazard bag.
- Check the venipuncture site for clotting.

- **For all SPs aged 1-11 and SPs not eligible for OGTT.** Apply a CoFlex dressing over the gauze pad. Instruct the SP to remove it in no less than 45 minutes if the bleeding has stopped. Also, suggest that the SP sit quietly for a few minutes. If bleeding continues, keep direct pressure on the site for 5 minutes or more.
- Corresponding computer-generated barcode labels print automatically, after the phlebotomist enters the quantity of tubes drawn. Label the 7-ml gray-top tube with the label containing the title VOC Blood, a barcode plus Sample ID – XXXXXX054 and a second barcode plus Astro ID. Place the barcode label on the 7 mL gray top tube so the lot number and expiration date of the tube is visible. Label all other tubes with barcoded labels with the barcode vertical on the tube. The time prints on the label.
- Place the rack containing the blood collection tubes in the pass-through window located over the sink.
- Report any adverse reaction to the venipuncture to the physician immediately and document the event by using the automated UFO utility.
- Escort the SP back to the coordinator.
- If blood has spilled on the phlebotomy chair, wash the area with a 10 percent solution of bleach and water, then prepare the workstation for the next SP. Routinely disinfect the phlebotomy chair with Sani-Wipes to disinfect. Wash hands and change gloves before approaching the next SP.
- Wash hands and change gloves before approaching the next SP.

3.10 Pediatric Venipuncture

Pediatric venipuncture requires special techniques. Because you will be dealing with children of different age ranges and levels of understanding, it is important to be able to recognize at what stage a child is in early in the venipuncture process.

Infants and toddlers, age 1 to 2 years, experience the world through their senses and do not have much of a language base. Therefore, verbal explanations are virtually meaningless. Expect crying and resistance from the start, even at the first touch. Restrain children of this age by enlisting the assistance of a medical technologist. The best techniques to use with these children are to maintain a reassuring tone, to reinforce that the child is a good boy or girl, and to draw the blood quickly. Be sure to reassure the child after the procedure and to use cartoon adhesive bandages, stickers, and a snack when finished.

Preschoolers, age 2 to 6 years, think concretely and in absolute terms; things are good or bad, right or wrong, painful or not painful. For these children, use simple, concrete terms when describing the procedure and its consequences. Always be honest. Try to avoid the word “take” which implies remove, “test” that implies pass or fail, and “fix” which implies broken. With children of this age, it is still important to emphasize that the child is a good boy or girl and to use colorful adhesive bandages, stickers, and a snack. Try using distractions, such as holding something, counting things in the room, and breathing deeply. These techniques may work with the older children in this age group. The phlebotomist may have a medical technologist assist with most of these children.

School-aged children, 7 to 12 years, have a better grasp of language and view the world more realistically. They understand past and future, that is, “this will be over soon,” and relative terms, such as “this will hurt a little or a lot.” Detailed explanations of the procedure are extremely effective. Again, always be honest. Include demonstrations, with a doll for example, whenever possible. Having the child help during the procedure distracts the child as well as letting him or her have some control. Be sure to reinforce how big a help he or she was after the draw. Give the child realistic choices, such as which arm to choose. You may need to consider having a medical technologist assist with some children even at this stage. Adhesive bandages continue to be important.

Although adolescents age 12 to 18 years are beginning to think abstractly, they often regress when placed in stressful situations. It is best to assume that they will act younger than their chronological age. However, it is still very important to address the adolescent as an adult and not as a child. Provide detailed explanations and inform him or her that the best technique is being used. It is very important that the adolescent maintain control of the situation; therefore, give him or her some choices, as well as allowing him or her to help if offered. Be very clear about rules, such as remaining motionless, but do not restrain the adolescent.

Pediatric venipunctures are most successful when children are immobile, the veins are maximally distended, and all supplies are handy. Many children prefer a cloth or gauze under the tourniquet to prevent pinching of skin.

The usual site for pediatric venipunctures is the antecubital fossa. Assess the size of the vein and use the appropriate needle size for a successful venipuncture. For difficult to find veins, use the veinlite as described in section 3.12 to locate a suitable vein and reassure the SP and the parent. Follow the general guidelines in Section 4.9 for performing venipunctures.

3.10.1 Age Specific Care And Phlebotomy

Exhibit 3-5. Age Specific Care And Phlebotomy by Terry Kotrla, MS, MT(ASCP)BB

What's Up with this "Age Specific Care?"

- The Joint Commission for Accreditation of Healthcare Organizations (JCAHO) requires that all healthcare staff annually meet competency expectations in performing Age Specific Care.
- An interpretation of the standards and their intent relates to all staff members who assess, treat, and manage, or who work in areas that have direct impact on, patients in age-specific populations.
- Managers are being challenged to make sure their phlebotomists are not only proficient at phlebotomy, but proficient with all age groups.

Phlebotomy Applications

- Basic knowledge of human growth and development
- Age specific interpersonal skills
 - Psychological needs
 - Social needs
 - Appropriate tone of voice, eye contact and active listening skills
- Technical expertise – physical skills

Age-Specific Groups

- Neonate/Infant 0-1
- Toddlers 1-3
- Pre-School 4-5 years
- School Age 5-12 years
- Adolescent 13-18
- Young Adult 19-35

Exhibit 3-5. Age Specific Care and Phlebotomy by Terry Kotrla, MS, MT(ASCP)BB (continued)

- Adulthood 36-65
- Late Adult 65+

Neonate/Infant Psycho-Social Needs

- Total dependence on parents/adults.
 - Older infant has fear of strangers and separation from parent.
 - Parent may hold child and provide comfort.
 - Pacify with bottle/pacifier or distract with toys.
 - Primary interaction will be with parent.
- Introduce yourself.
- Gentle, comforting tone of voice.
- Compassionate expression and body language.
- Clearly explain the procedure.
 - Older infants - talk slowly and make eye contact.

Neonate/Infant – Fears/Safety

- Try not to separate from parent unless absolutely necessary.
- Do not perform venipunctures on infants less than 6 months of age unless absolutely necessary.
- For heelsticks follow recommended procedures to the letter.
- Collect minimum amount of blood necessary.

Toddlers 1-3 Years Psycho-Social Needs

- Try not to separate from parent unless absolutely necessary.
- Parent may assist by holding, explaining to and comforting the child.
- Friendly, cheerful and empathetic manner.

Exhibit 3-5. Age Specific Care and Phlebotomy by Terry Kotrla, MS, MT(ASCP)BB (continued)

- Speak before you touch, use child's name.
- Explain procedure in soothing tone using age appropriate terms; children this age fear pain.
- Emphasize cooperation.
- Praise child during procedure.
- Encourage parent to praise child after procedure.

Toddlers 1-3 Years – Fears/Safety

- Childproof area, no supplies in reach.
- Be prepared, have all supplies needed to avoid delay.
- NEVER say “This will not hurt”, rather use age appropriate terms and it's ok for them to say “ouch.”
- Distract with a toy or other object.
- If appropriate, keep child informed on how much longer it will be.
- Band-aids may not be appropriate, child may swallow and choke.

Pre-School 4-5 years Psycho-Social Needs

- Parent may be present to provide emotional support and to assist in obtaining child's cooperation.
- Approach in friendly, cheerful and empathetic manner, use child's name.
- Explain procedure in soothing tone using age appropriate terms, children this age fear pain
- NEVER say “This will not hurt”; rather use age appropriate terms and it's ok for them to say “ouch.”
- Keep child informed on how much longer it will be.
- Praise for bravery, say “Thank you.”

Exhibit 3-5. Age Specific Care and Phlebotomy by Terry Kotrla, MS, MT(ASCP)BBlege (continued)**Pre-School 4-5 – Fears/Safety**

- Child proof collection area.
- Fear of pain.
- Avoid delays, have all equipment.
- Assemble equipment out of child's eye sight.
- Use your best judgment whether to encourage child to look away.
- Involve child in after care by allowing selection of bandaid and sticker.

School Age 6-12 – Psycho-Social Needs

- Increased language skills and self-control.
- Move from security seeking behavior towards independence.
- Try not to embarrass the child.
- Must communicate with them as an individual using age appropriate words and appropriate eye contact.
- May want parent to hold hand.
- Explain the procedure and why blood is needed.
- Be prepared to answer questions.

School Age 6-12 – Fears/Safety

- Younger ages fear of pain, older ages may “act” brave.
- Younger ages may need distraction such as a toy or other object.
- Explain use of equipment if appropriate.
- Reassure the patient during the procedure.
- Let them know how much longer.
- Explain the importance of maintaining pressure after completion of procedure.

Exhibit 3-5. Age Specific Care and Phlebotomy by Terry Kotrla, MS, MT(ASCP)BB (continued)**Adolescent 13-18 Psycho-Social Needs**

- Maintain privacy.
- Concerned with the present more than the future.
- Conscious of appearance.
- Actively involved in anything concerning the body.
- Engage in behaviors to establish they are an adult.
 - May be hypersensitive or non-interactive.
 - May act hostile to hide fear.
 - Important to assess the patient and use appropriate interpersonal skills.
- Take extra time for explanations and or preparation.

Adolescent 13-18 – Fears/Safety

- Embarrassed to show fear.
- Adolescent male has greater potential for fainting.
 - Periodically check for pre-syncope signs.
 - Be aware of sudden silence in a previously talkative patient or extremely talkative after previously silent.
- Keep up a running conversation to distract the patient.
- Stress importance of post-phlebotomy care.

Young Adult 19-35 Psycho-Social Needs

- Reflect on interests, goals and aspirations for the future.
- Focused on preservation and maintenance of health.
- May work and play too hard and sacrifice sleep, nutrition and exercise.

Exhibit 3-5. Age Specific Care and Phlebotomy by Terry Kotrla, MS, MT(ASCP)BB (continued)

- May experience anxiety, stress and depression related to work, marriage, parenting and social expectations.
- More involved with healthcare decisions, may ask questions putting you “on the spot.”
- Communicate in a professional manner.
 - Explain why you cannot answer certain questions.
 - Do not patronize or talk down to the patient.
 - Clearly and honestly explain the procedure.
- Avoid negative body language.
- Eye contact critical, promotes sense of trust but be aware of cultural differences.

Young Adult 19-35 – Fears/Safety

- Can possess same fears as pediatric patient.
- Confidence and professionalism are essential to set patient at ease.
- Be aware of signs of syncope, especially in fasting or GTT patients.
- Stress importance of post-phlebotomy care.

Adulthood 36-65 Psycho-Social Needs

- Generativity vs stagnation.
- Prepares for empty nest.
- Adapts to aging process.
- Older, wiser and more likely to be at peace with society and self.
- Health problems may require prescription drugs.
- Interpersonal skills the same as the young adult.

Adulthood 36-65 – Fears/Safety

- Rarely fearful of the procedure.

Exhibit 3-5. Age Specific Care and Phlebotomy by Terry Kotrla, MS, MT(ASCP)BB (continued)

- Stress post-phlebotomy site care ESPECIALLY for patients on anti-coagulant therapy.
- Site should always be checked before patient leaves.

Late Adult 65+ Psycho-Social Needs

- Aging process continues.
- Reduced attention span and memory.
- Experiences anxiety over loss, isolation and changes.
- Reflect on their lives and come to accept death.
- Due to loneliness may take more of your time.
- Challenges due to neurological and physical disabilities.

Late Adult 65+ – Fears/Safety

- “Normal” older adults not a problem.
- Patients with physical or neurological problems can present very challenging problems.
- Ask for assistance if limbs must be manipulated or held still.
- Take GREAT care to select your equipment.
- Provide exceptional aftercare to prevent bruising.
- Band-aids MAY NOT be appropriate for elderly patients with “paper thin” skin.

Summary

- Define the age specific categories
- Create study materials based on your institution’s unique patient population.
- Define competencies.
- Conduct annual assessments, observation, written test, or combination.
- Develop remediation plan.
- Research and revise annually.

References

Kirven, D.R. Age-specific techniques in phlebotomy competency. (2003). *Advance for Medical Laboratory Professionals*, 14(6), pp. 11-17. Retrieved from https://www.cdc.gov/nchs/data/nhanes/nhanes_13_14/2013_MEC_Laboratory_Procedures_Manual.pdf.

University of Texas Medical Branch (UTMB), Clinical Pathology Services. (2009). Phlebotomy Age Specific Competencies [training document]. Galveston, Texas: Author. Retrieved from http://www.utmb.edu/pcs/images/pcsvcs_137741.pdf.

3.11 Hand Venipuncture

It is acceptable to use dorsal hand veins as the venipuncture site. This site should be used only if the antecubital veins are unsuitable, such as when the antecubital area is edematous, burned or scarred, there are casts on both arms, or the veins are thrombosed.

- Select a vein that is palpable, lightly brushing a finger across the back of the hand as it is palpated. This helps select the best vein and determines its direction. Palpate even when the vein is visible.
- Use a 21-gauge or 23-gauge butterfly blood collection set, depending on the condition of the SP's veins.
- Follow the venipuncture technique described in Section 3.9.3 to draw the blood.

3.12 Veinlite EMS

Supplies

- Two AA alkaline batteries; and
- Disposable plastic covers.

The TransLite Veinlite EMS is a hand-held battery powered transillumination device for finding veins and assisting in vein access. It utilizes side-transillumination, which enables the VeinLite EMS to uniformly illuminate a small region of skin and subcutaneous tissue, anywhere on the body, without any areas of shadow.

- Place the Veinlite EMS inside the disposable plastic cover. Check the cover to make sure it is intact.
- Wipe the area of the plastic cover coming in contact with the study participant with an alcohol prep pad.
- Turn off any overhead fluorescent lights as these may interfere with transillumination. Low power, nonfluorescent side lighting may be used.
- Visually locate the region of the skin you wish to examine for veins and then place the Veinlite EMS over it, with the LEDs facing down toward the skin (Exhibit 3-6).
- Apply gentle pressure to the Veinlite EMS to ensure it is in contact with the skin.
- Depress the orange button to switch on the LEDs.
- To access a vein while viewing with the Veinlite EMS, place the Veinlite EMS so the opening in the circle of the LEDs faces away from the heart. Apply gentle pressure on the Veinlite EMS to hold the vein. Pull back slightly on the Veinlite EMS to stretch the skin and provide a taut surface for the venipuncture (Exhibit 3-7).
- Insert needle in the normal way.
- Discard the disposable plastic cover after each study participant and switch off the Veinlite EMS when it is not in use.

Exhibit 3-6. Position of Veinlite EMS while looking for a vein



Exhibit 3-7. Position of Veinlite EMS while accessing a vein



Caution: Do not look at the LEDs when they are switched on or shine the light from the LEDs into anyone's eyes.

Cleaning. Wipe the device, after each use, with a Sani-Cloth or alcohol prep pad. Do not immerse the device in liquid.

3.13 Recording the Results of the Venipuncture Procedure

The Venipuncture screen displays the tube protocol for the SP. The blood tubes are listed in the order they should be drawn.

train-05
File Edit View Settings Ctrl Alt
P:\medcom\Standa015 Session015010 11/15/2010 08:30 am - 12:30 pm
SP ID: 553872 Name: WRIGHT, LAYLA B Age: 21 years Gender: Male Date: 12/21/2012 Time: 04:36 PM
Venipuncture

4 ml lavender	0	of 2	<input checked="" type="checkbox"/> Obtained all 553872
2 ml gray	0	of 1	
15 ml red	0	of 3	
15 ml red	0	of 2	

Each SP's profile is dependent on his or her age, appointment type, selection for inclusion into randomly-selected subsamples, and the session time.

Immediately after completing the venipuncture, enter the results of the blood draw, the reasons for a tube not being drawn according to the protocol, and any comments about the venipuncture.

train-05
File Edit View Settings Ctrl Alt
P:\medcom\Standa015 Session015010 11/15/2010 08:30 am - 12:30 pm
SP ID: 553872 Name: WRIGHT, LAYLA B Age: 21 years Gender: Male Date: 12/21/2012 Time: 04:36 PM
Venipuncture

4 ml lavender	2	of 2	<input type="checkbox"/> Obtained all 553872
2 ml gray	1	of 1	
15 ml red	3	of 3	
15 ml red	2	of 2	

Comment:

4:38 PM

To record all tubes as filled or obtained, move the mouse to the “Obtained all” checkbox and click, or type [Alt] [B]. This records a check mark in the box and marks all tubes as obtained. To mark individual tubes as filled or obtained, direct the mouse arrow to the up-down controls on the spin box and toggle the number of each tube up or down or type the correct number using the numeric keys.

For the 7-ml gray (VOC) tube, if the SP is not included in the one-third subsample, but is a smoker, an asterisk will be displayed next to the 7-ml gray tube on the third screen of the phlebotomy application.

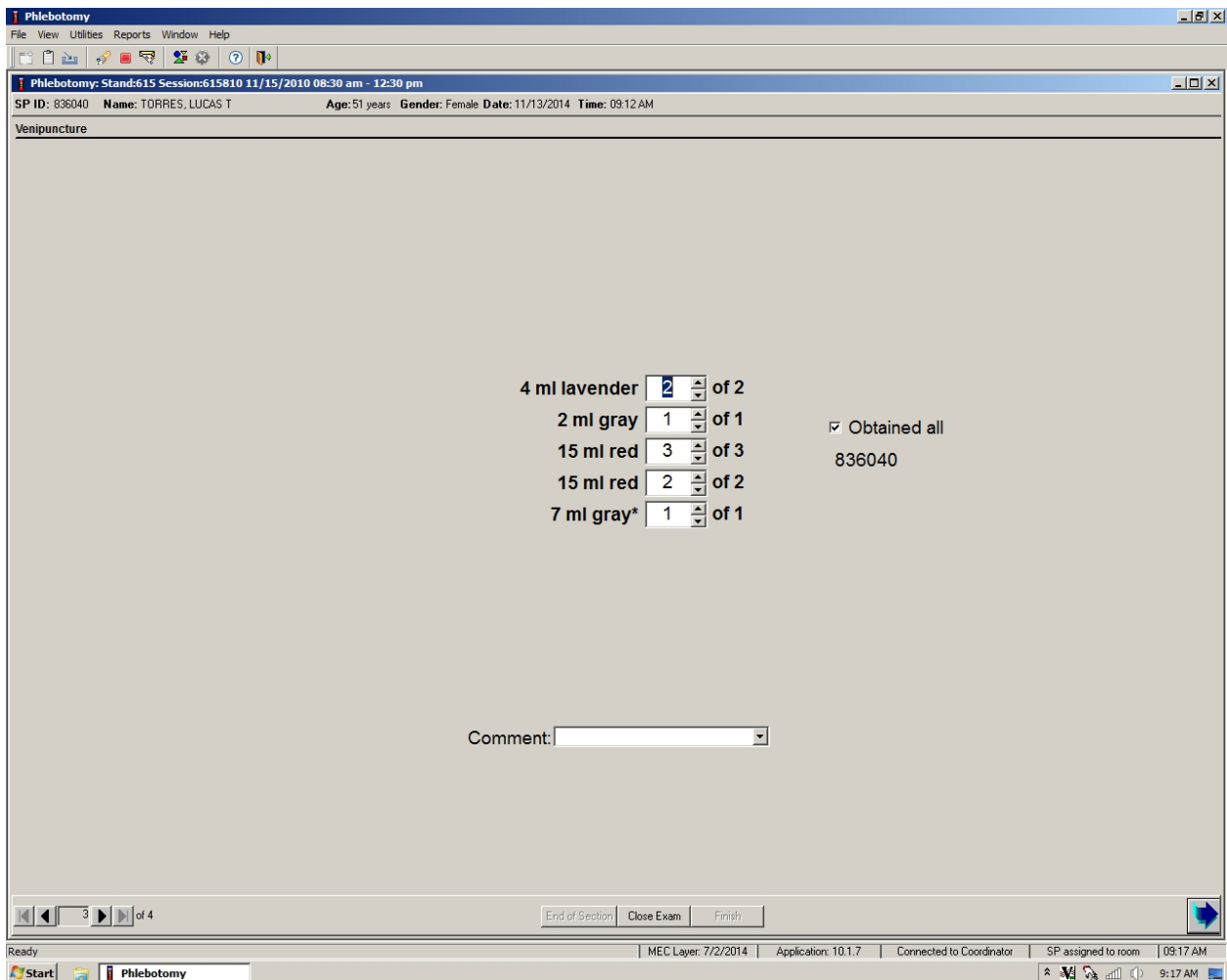

For SPs 40+, the phlebotomy application will differentiate the first and second lavender tubes drawn. This is a requirement for the lab staff to determine which tube to process the Cr/Co vessel. The phlebotomist will be responsible for placing the “Lavender 1” label on the first 4-ml lavender tube drawn and the “Lavender 2” label on the second 4-ml lavender tube drawn.

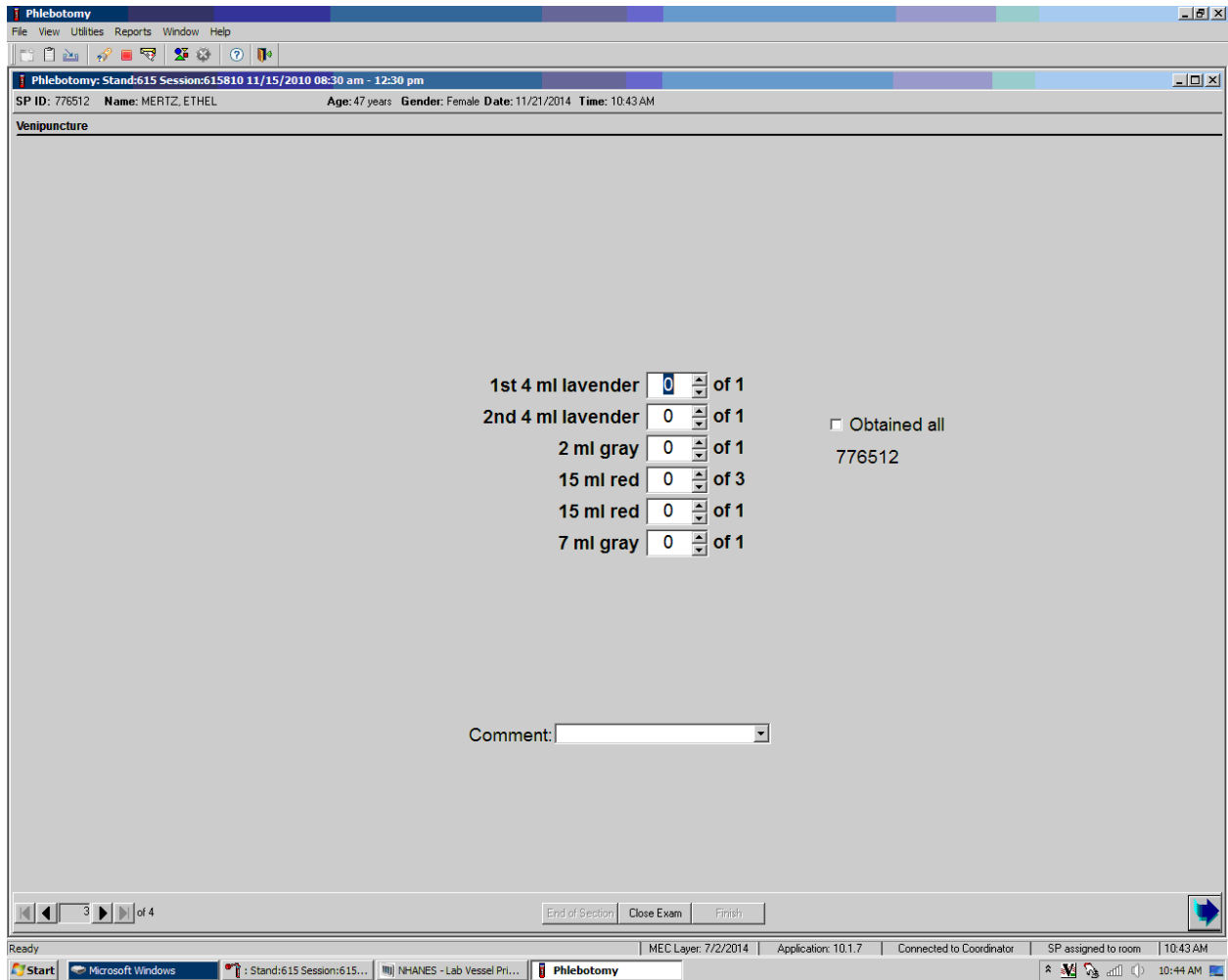

Document circumstances where the alternative protocol was used or the SP was in the supine position.

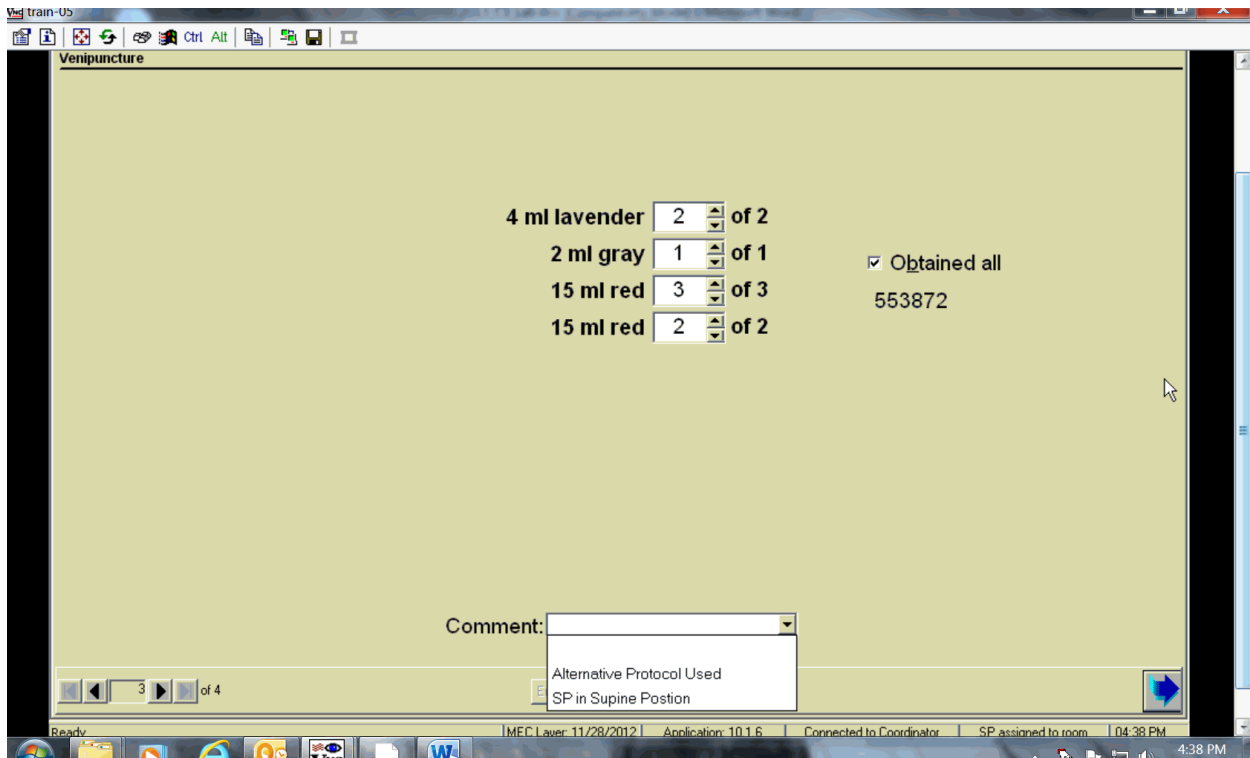

To record either “Alternative Protocol Used” or “SP in Supine Position” comments in the Comment text box, move the mouse to the arrow on the drop-down list, left-click, drag the mouse arrow to the desired choice, and left-click. Alternatively, type [A] for “Alternative Protocol Used” or [S] for “SP in Supine Position” and Enter, or use the up and down arrows to toggle between the two choices and [Tab.]

To progress to the next screen, direct the mouse arrow to the bright blue arrow in the bottom right corner and left-click, or press Enter when this blue arrow is highlighted.

To reprint the Dymo labels, move forward one screen and back using the navigation arrows. A Print Labels informational text box displays. It is also possible to reprint labels in the review mode.

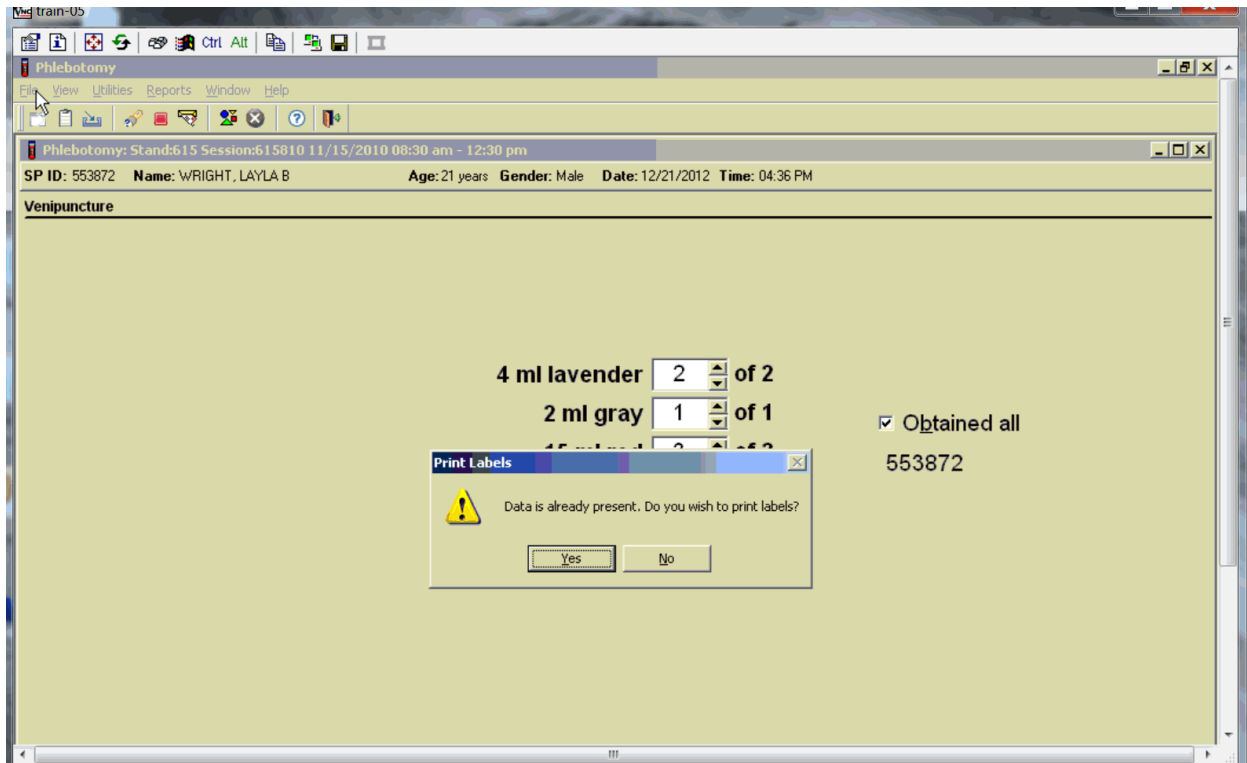

To reprint the labels, direct the mouse arrow to the arrow on the “Yes” button, and left-click. To remove the Print Labels informational text box without reprinting the labels, direct the mouse arrow to the “No” button and left-click.

3.14 Venipuncture Status

Verify the venipuncture status.

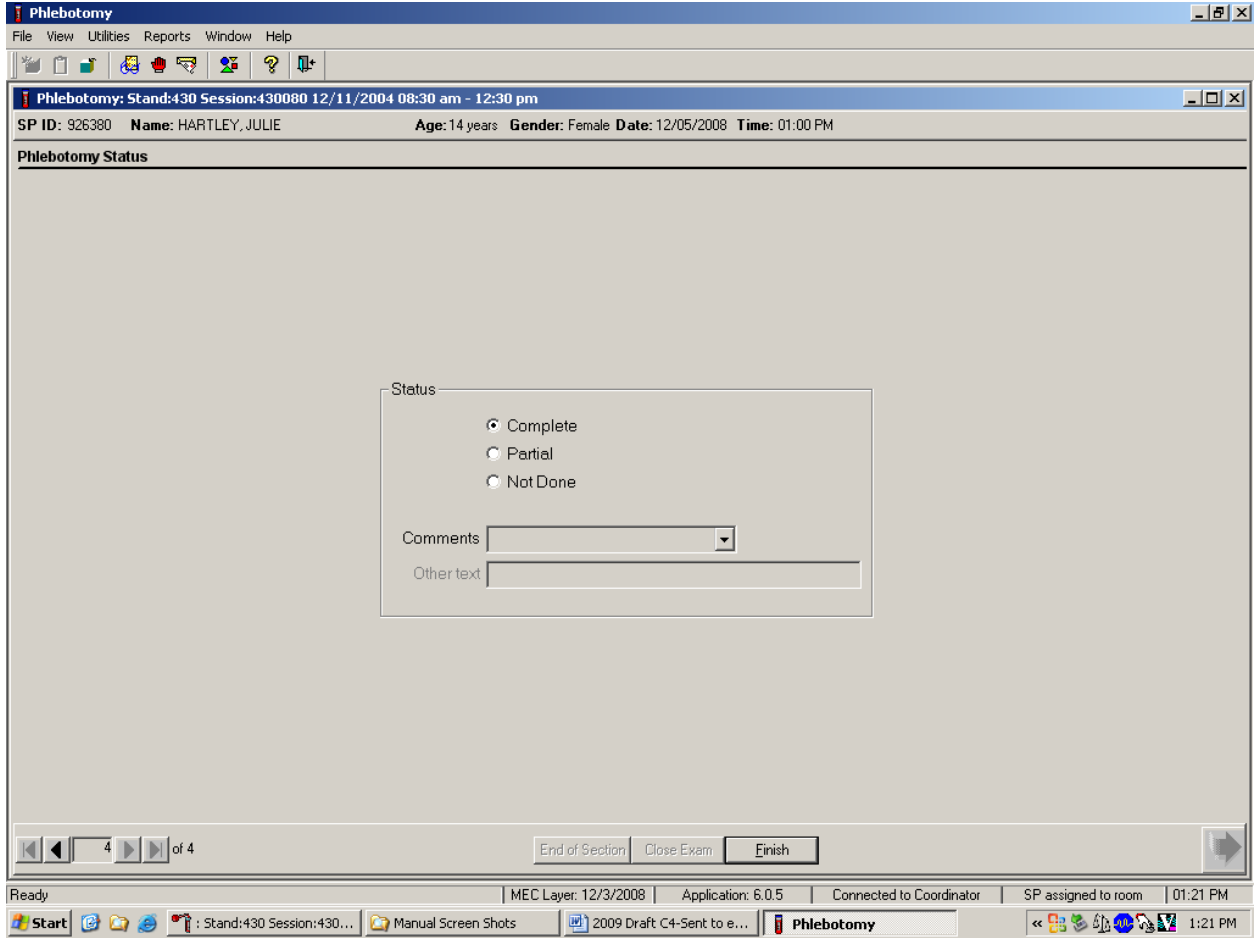

The venipuncture status is complete if all tubes were collected.

Comment codes are used to explain Partial and Not Done status codes.

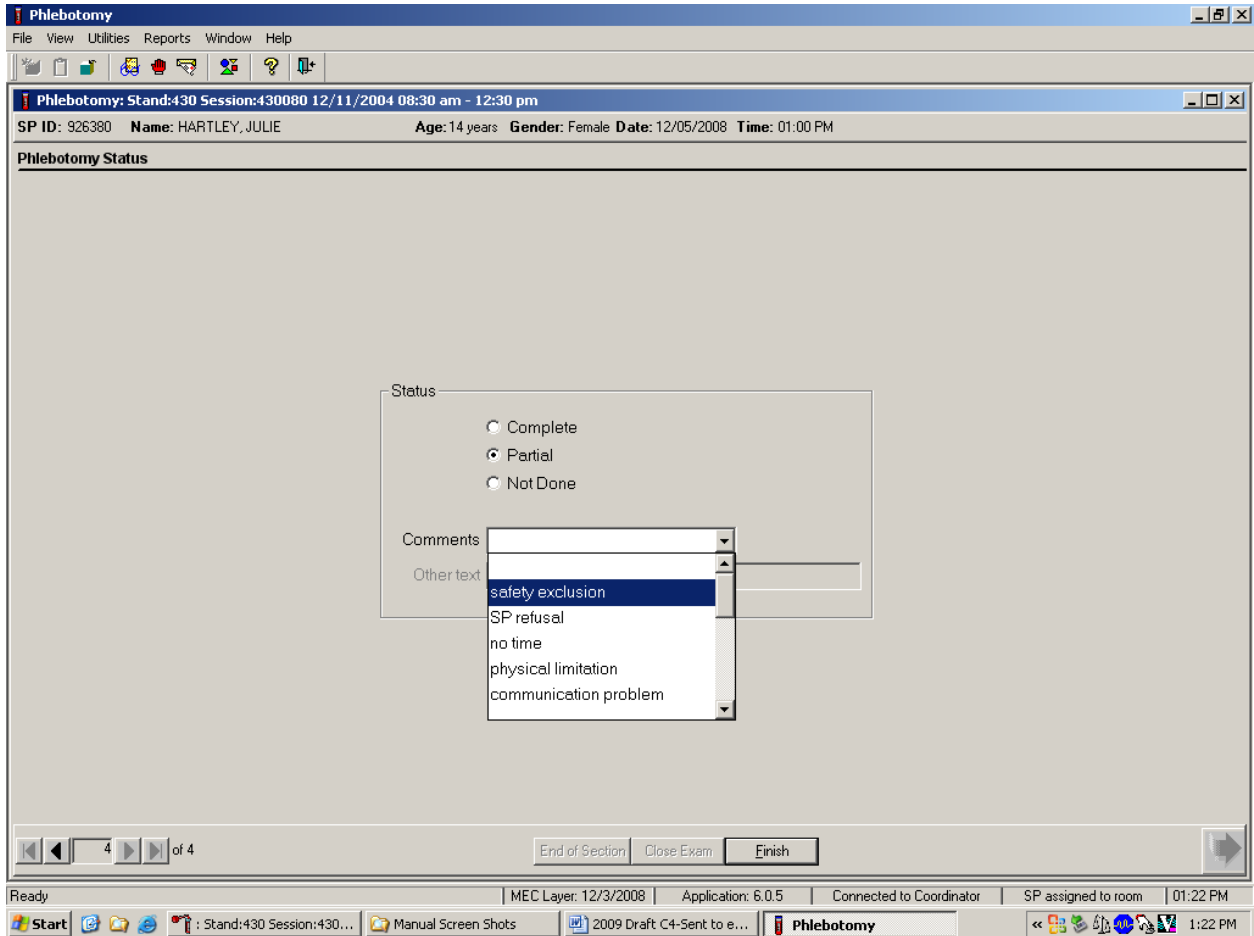

Choose and enter the appropriate comment code when the venipuncture section status is Partial or Not Done. To record a comment in the Comments text box, direct the mouse arrow to the scroll arrow on the drop-down list, left-click, drag the mouse arrow to the desired choice, and left-click. Use the scroll bar to view all choices. Alternatively, use the up and down keyboard arrows to scroll through the choices or type the first letter of the desired comment code.

Exhibit 3-8 presents the comment codes for partial or not done venipuncture.

Exhibit 3-8. Comment codes for Partial and Not Done venipunctures

Comment code	Use when:
Safety exclusion	Not applicable. This is reserved for positive responses to the hemophilia and chemotherapy exclusion questions and it is automatically coded by the application. The coordinator may code exams using this comment.
SP refusal	The SP refuses to have his or her blood collected. This is an SP-initiated nonresponse due to refusal. The SP refuses the component for any reason other than an illness or emergency. All SPs will be sent to the exam room to have their arm band barcode scanned and coded. If the SP refuses after starting the exam, the examiner codes the exam. Use this comment to code partial exams when the SP refuses after one tube has been drawn, or the blood flow stops after one tube but before all tubes have been successfully drawn.
No time	Not applicable.
Physical limitation	Not applicable.
Communication problem	Not applicable.
Equipment failure	Not applicable.
SP ill/emergency	Not applicable.
Interrupted	Not applicable.
Error (technician/software/supply)	Use this comment to code Partial and Not Done exams when there are phlebotomist errors, or software or supply issues.
Other, specify	If the above reason for a status code of Not Done is not explained by one of the comment codes, the examiner must choose Other, specify and record a comment in the text field.
No suitable vein	Use this comment to code exams as Not Done (no tubes drawn) when the SP does not have an accessible vein, any arms available, casts on both arms, there is a rash over the entire area, or the blood draw was started but there was no blood in the tubing.
Vein collapsed	Use this comment to code exams as Partial when one or more tubes are successfully drawn but blood flow stops before all tubes are drawn or when the vein collapses.
SP not feeling well	Use this comment to code Not Done or Partial when the SP is about to faint or the SP became ill and the test could not be performed on the SP.
Fainting episode	Use this comment to code Not Done or Partial when the SP faints and the test could not be performed on the SP.
No tubes drawn	Use this comment to code exams as Partial when no tubes are drawn.
Language barrier	Use this if SP is unable to understand English and an interpreter is not available.

When finished, direct the mouse arrow to the bright blue arrow in the bottom right corner and left-click to exit or press Enter when this blue arrow is highlighted.

Escort the SP to the location indicated in the Message Center text box.

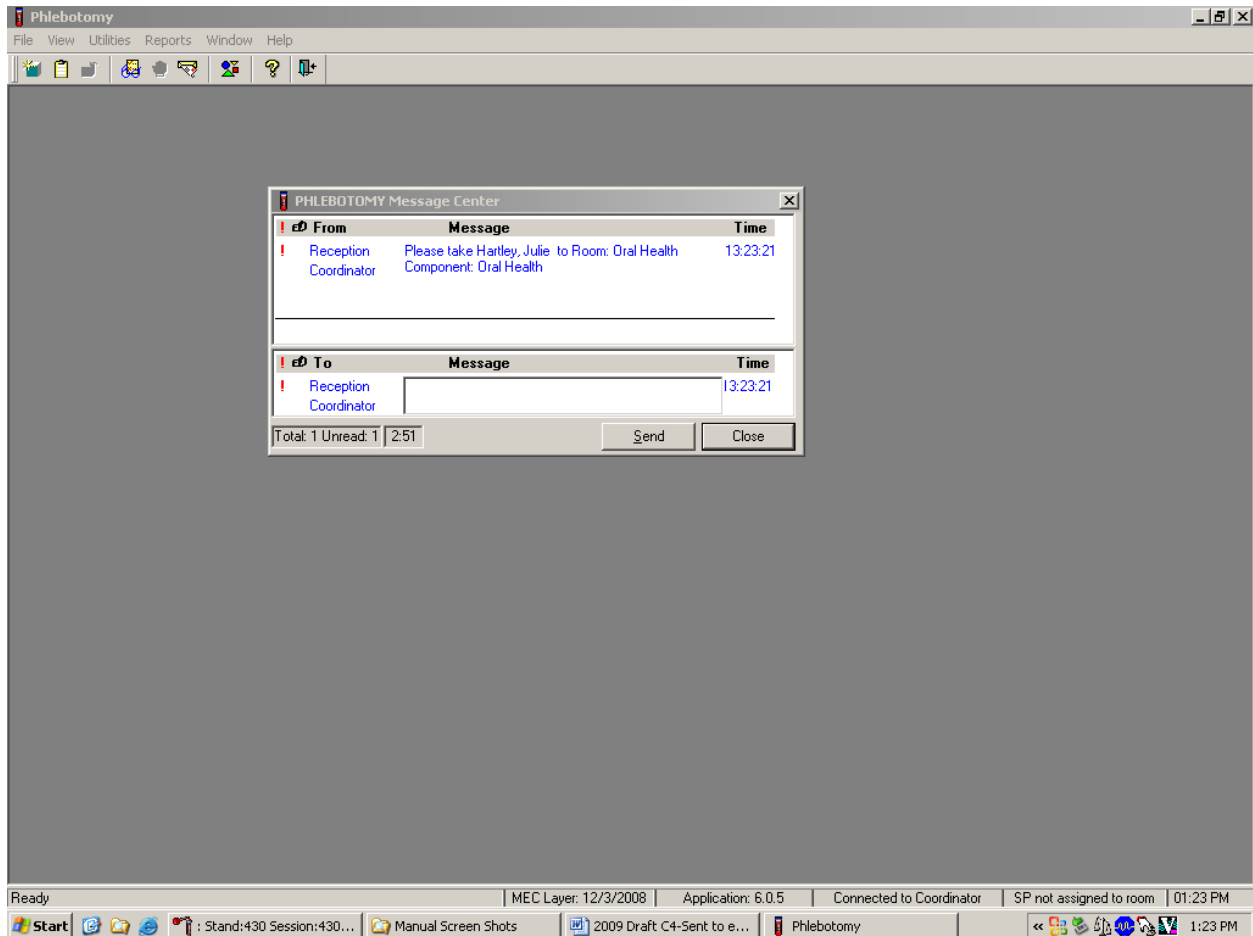

Review the instructions in the Message Center text box and follow the directions.

3.15 Repeat Blood Draw

In rare circumstances, a result from the complete blood count may be an extreme value that would be considered a “panic” value in clinical practice. An example is severe thrombocytopenia. The physician may repeat the complete blood count if the participant reports no history of nosebleeds or prolonged bleeding and the physician verifies that the site of the first venipuncture clotted normally. The second complete blood count will overwrite the first results in ISIS and will be used for reporting and referrals.

Problem Identification

Rare occurrences of critical CBC results, particularly low platelet counts, have been observed that resulted in an awkward medical referral for the physicians on the MEC. While the medical technologists and physician may suspect a laboratory instrument or blood collection effect in the reported results, it is not standard practice to repeat the test with a new blood specimen from a second phlebotomy. There is nothing in the phlebotomy, laboratory, and physician protocols that requires a second blood draw on an SP when critical results are obtained.

False low platelet results (low) are most likely the result of micro clots that cannot be observed. The techs do visually look for clots but they will not see micro clots. Many false low platelet results are caused by cold agglutinins. The techs are able to recognize cold agglutinins because the platelet number will decrease each time the blood is run. In this instance they warm the blood and rerun the sample. To warm the blood sample, place the tube in an insulated cup with 40°C water for 5 minutes. Use the certified thermometer in lab to ensure the temperature does not go below 37°C.

The NHANES protocol is unusual because it requires the techs to run all samples in duplicate (whenever possible), whereas a clinical lab would rerun a sample only if the result was abnormal.

Recommended Action

If the physician feels a repeat blood count is needed, then he or she has the discretion to discuss this with the SP and have the phlebotomist draw a 3-ml EDTA tube for a repeat CBC if the SP agrees. Prior to a second phlebotomy, the physician should visually inspect the site of the first venipuncture to rule out prolonged bleeding. If the puncture site looks normal, then a second phlebotomy can be requested. The SP always has the right to refuse the blood draw. The need for this action should be rare as evidenced by the four total low platelet counts in the last 2 years.

After the physician reviews the findings with the SP, and the SP agrees to a repeat CBC phlebotomy:

- The physician should consult with the MEC manager and chief medical technologist to arrange to have the blood drawn at the next earliest opportunity.
- This additional blood draw will not be supported by the laboratory and phlebotomy applications.

- As long as the SP has not checked out of the MEC or if the Report of Findings has not been printed, the lab application will allow the medical technologists to overwrite the existing CBC data with the new data and the new data will become the final result of record.
- The physician will document this event under observations in the physician application.

3.16 Phlebotomy Quality Control

Perform phlebotomy quality control at the start of the first session even if there are no SPs scheduled into either session. Record the room temperature reading and the action that the counters were disinfected using the End of Session tab. Record the supply lot numbers and expiration dates by using the Supply Use tab.

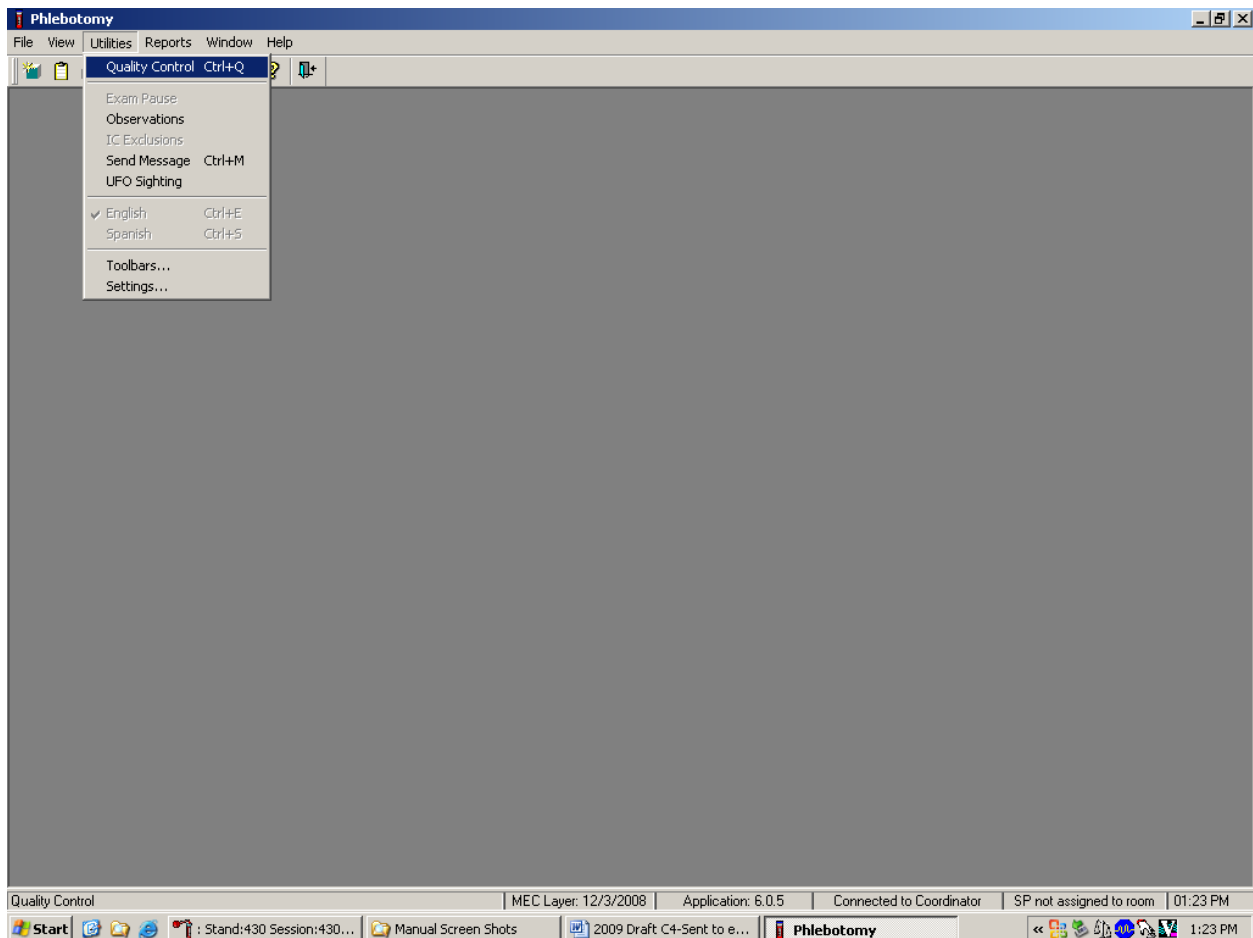

To access the phlebotomy Quality Control module, direct the mouse arrow to Utilities in the menu bar, left-click, drag the arrow to Quality Control and left-click.

3.16.1 Daily Quality Control

Record the daily quality control activities at the start of the first session. Mark each Done checkbox with a check mark.

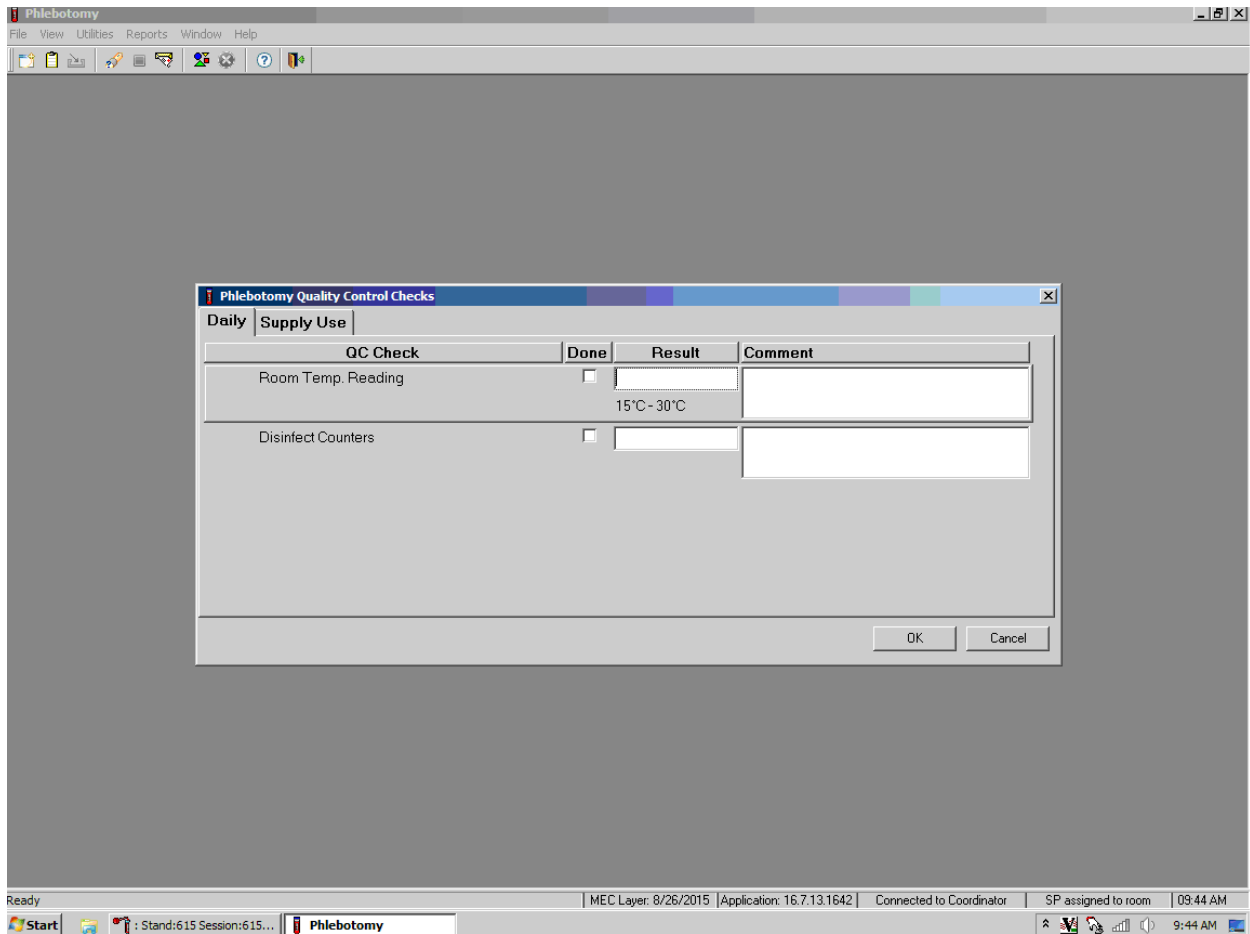

To record a check mark in the Room Temp. Reading checkbox, direct the mouse arrow to the checkbox in the Done column and left-click, and then press Tab to move to the Result text box. Enter the temperature in the Result text box and press Tab to move to the Comment text box. If the reading is outside the established range (15-30°C), document the actions taken to resolve the situation in the Comment text box. Press Tab to move to the next Quality Control item.

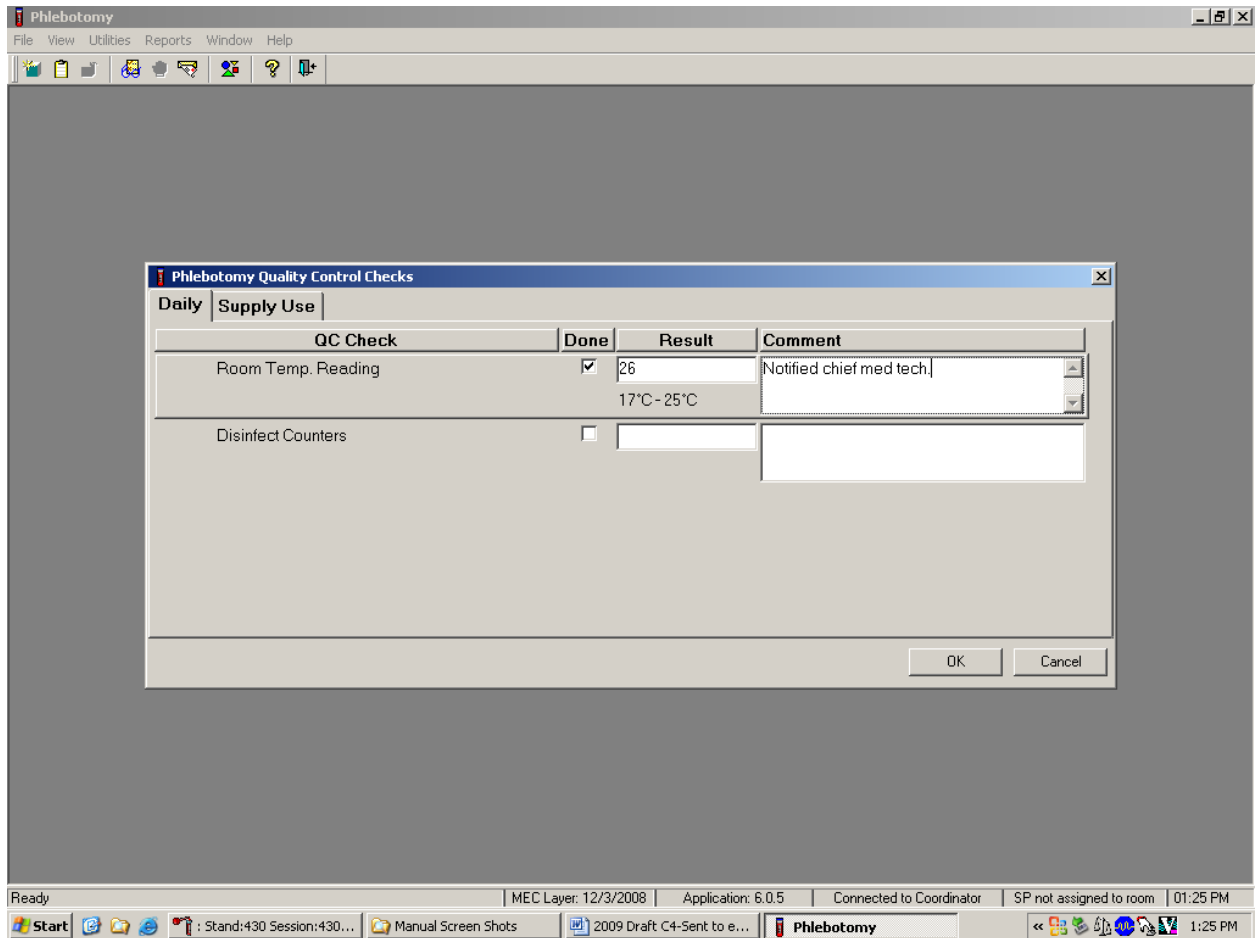

To record a check mark in the Disinfect Counters checkbox, direct the mouse arrow to the checkbox and left-click, and then press Tab to move to the Result box. Type “Yes” or “Not Done” in the Disinfect Counters Comment text box and then Tab to add free-form text explaining why the counters were not disinfected for any “Not Done” response.

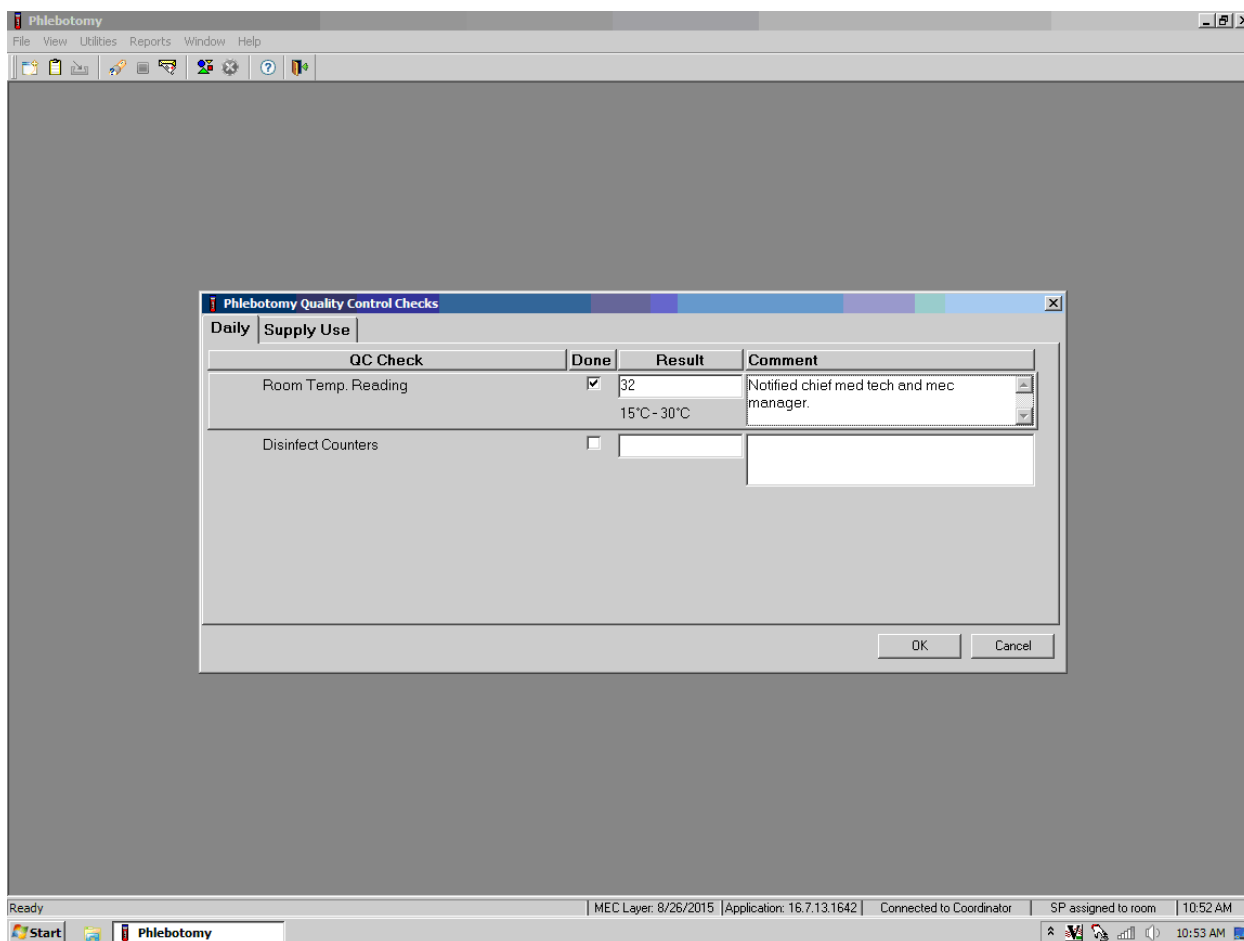

3.17 Red Cross Procedures for Handling Fainting (Syncope)

“Fainting” is a partial or complete loss of consciousness. This is due to a reduced supply of blood to the brain for a short time. Occasionally, a person collapses without warning. Recovery of consciousness usually occurs when the victim falls. Injury may occur from the fall. To prevent a fainting attack, a person who feels weak and dizzy should lie down or bend over with his or her head at the level of the knees.

Signs and symptoms include:

1. Extreme paleness;
2. Sweating;
3. Coldness of the skin;

4. Dizziness;
5. Numbness and tingling of the hands and feet;
6. Nausea; and
7. Possible disturbance of vision.

If at any time during the venipuncture procedure the SP exhibits any of the manifestations listed above, conclude the venipuncture immediately and perform the first aid procedures listed below.

- Place the SP in a supine position.
- Loosen any tight clothing and keep crowds away.

Provide a disposable airsickness bag if the SP vomits and either roll the SP onto his or her side or turn the SP's head to the side.

- Maintain an open airway.
- **Do not** pour water over the SP's face because of the danger of aspiration; instead, provide a cool wet cloth to the forehead.
- **Do not** give any liquid unless the SP has revived.
- Examine the SP to determine if he or she has suffered injury from falling.
- Seek medical assistance. Do not leave the SP. Call for assistance or use the intercom to speak to the coordinator. Observe the SP carefully afterward because fainting might be a brief episode in the development of a serious underlying illness.¹

3.18 How to Deal With System Failure

If the computer system fails, record results on a preprinted Phlebotomy Worksheet (Exhibits 3-9 and 3-10). Complete a Phlebotomy worksheet for each survey participant (SP) while conducting the exam. Enter the results after the system is operational.

¹ From *Standard First Aid and Personal Safety*, Second Edition, the American Red Cross, New York: Doubleday and Company, Inc., 1981, pp. 173-174.

Exhibit 3-9. Phlebotomy worksheet – English Primary

**PHLEBOTOMY INTERVIEW, FASTING INTERVIEW, and PROTOCOL
PRIMARY SP**

SP ID _____

Phlebotomy Interview	Responses <u>Yes</u> , <u>No</u> , <u>Refused</u> , <u>Don't know</u>	
Are you currently pregnant? (Females ages 12-59 or 8-11 if menstruating)		
Do you have hemophilia?		
Have you received cancer chemotherapy in the past 4 weeks?		
Fasting Questionnaire	Record time and date	
Q1. When was the last time you ate or drank anything other than plain water? Do not include diet soda or black coffee or tea with artificial sweeteners like Sweet'N Low, NutraSweet, Equal, or Splenda.		
Confirmation Question: Q2. Have you had any of the following since {insert time from Q1 here}?	Responses <u>Yes</u> , <u>No</u>	If Yes, record time and date
Coffee or tea with cream or sugar? [Include milk or non-dairy creamers.]		
Alcohol, such as beer, wine, or liquor?		
Gum, breath mints, lozenges, or cough drops, or other cough or cold remedies?		
Antacids, laxatives, or anti-diarrheals?		
Dietary supplements such as vitamins and minerals? [Include multivitamins and single nutrient supplements.]		
Primary SP Protocol	# Filled	Not Filled
3-ml lavender (1 age 1-2, 2 age 3-5 and 1 age 40+)		
4-ml lavender (2 ages 6+)		
2-ml gray (morning only 1 age 12+)		
7-ml royal blue tops (1 age 6+)		
3-ml red (2 age 1-2)		
7-ml red (2 age 3-5, 1 age 6-11 and 1 age 12+)		
15-ml red (2 age 12+)		
10-ml red (1 age 6-11)		
15-ml red (3 age 12+ if eligible for Persistent Pesticides, Perfluorinated, and BFR subsamples)		
7-ml gray (1 age 12+ if eligible for VOC subsample)		
Comments:		

Exhibit 3-10. Phlebotomy worksheet – Spanish Primary

**PHLEBOTOMY INTERVIEW, FASTING INTERVIEW, and PROTOCOL
PRIMARY SP**

SP ID _____

Phlebotomy Interview	Responses <u>Yes</u> , <u>No</u> , <u>Refused</u> , <u>Don't know</u>	
¿Tiene hemofilia?		
¿Ha recibido algún tratamiento para el cáncer en las cuatro semanas pasadas??		
Fasting Questionnaire	Record time and date	
Q1. ¿Cuándo fue la última vez que comió o tomó alguna cosa aparte de agua sola? No incluya soda de dieta o café o té solo endulzado con endulzadores artificiales como Sweet'N Low, NutraSweet, Equal o Splenda.		
Confirmation Question: Q2. ¿Ha tomado o comido algo de lo siguiente desde ayer a las {insert time from Q1 here}?	Responses <u>Yes</u> , <u>No</u>	If Yes, record time and date
¿Café o té con crema o azúcar? [Incluya leche o cremas que no sean productos lácteos.]		
¿Alcohol, tal como cerveza, vino o licor?		
¿Chicle, mentas para el aliento, tabletas o pastillas para la tos, u otra medicina para la tos o el resfriado?		
¿Antiácidos, laxantes, o antidiarréicos?		
¿Suplementos para la dieta tales como vitaminas y minerales? [Incluya multivitaminas y suplementos nutritivos individuales.]		
Primary SP Protocol	# Filled	Not Filled
3-ml lavender (1 age 1-2 and 2 age 3-5)		
4-ml lavender (2 age 6+)		
2-ml gray (morning only 1 age 12+)		
7-ml royal blue tops (1 age 6+)		
3-ml red (2 age 1-2)		
7-ml red (2 age 3-5, 1 age 6+)		
15-ml red (2 age 12+)		
10-ml red (1 age 6-11)		
15-ml red (3 age 12+ if eligible for Persistent Pesticides, Perfluorinated, and BFR subsamples)		
7-ml gray (1 age 12+ if eligible for VOC subsample)		
Comments:		

The following four screenshots document the English text and official Spanish translations for the phlebotomy component:

- Phlebotomy Interview – English,
- Phlebotomy Interview – Spanish,
- Fasting Questionnaire – English, and
- Fasting Questionnaire – Spanish.

Phlebotomy Interview – English

The screenshot shows a web-based form titled "Phlebotomy Interview". At the top, there is a header bar with the text "Stand:410 Session:410500 10/07/2004 08:30 am - 12:30 pm". Below this is a menu bar with "File", "View", "Utilities", "Reports", "Window", and "Help". A toolbar with various icons is visible. The main content area displays patient information: "SP ID: 312716", "Name: HAMILTON, BARBARA", "Age: 48 years", "Gender: Female", "Date: 12/09/2008", and "Time: 12:58 PM". The form title "Phlebotomy Interview" is centered at the top of the main area. Below the title, there are three questions, each followed by a dropdown menu set to "No":
1. "Are you currently pregnant?"
2. "Do you have hemophilia?"
3. "Have you received cancer chemotherapy in the past four weeks?"
At the bottom of the form, there are navigation buttons: "End of Section", "Close Exam", and "Finish". A status bar at the very bottom indicates "1 of 4".

Phlebotomy Interview – Spanish

Stand:410 Session:410500 10/07/2004 08:30 am - 12:30 pm

File View Utilities Reports Window Help

Phlebotomy: Stand:410 Session:410500 10/07/2004 08:30 am - 12:30 pm

SP ID: 312716 Name: HAMILTON, BARBARA Age: 48 years Gender: Female Date: 12/09/2008 Time: 12:58 PM

Phlebotomy Interview

¿Está usted actualmente embarazada? No

¿Tiene hemofilia? No

¿Ha recibido tratamiento de quimioterapia para el cáncer en las cuatro semanas pasadas? No

Fasting Questionnaire – English

Phlebotomy

File View Utilities Reports Window Help

Phlebotomy: Stand:410 Session:410500 10/07/2004 08:30 am - 12:30 pm

SP ID: 306325 Name: KAIGA, NEWTON Age: 13 years Gender: Male Date: 12/09/2008 Time: 12:54 PM

Fasting Questionnaire

When was the last time you ate or drank anything other than plain water? Do not include diet soda or black coffee or tea with artificial sweeteners like Sweet'N Low, NutraSweet, Equal, or Splenda. 09:30 PM 12/08/2008

Have you had any of the following since yesterday at 9:30 PM?

Coffee or tea with cream or sugar? [Include milk or non-dairy creamers.] No : //

Alcohol, such as beer, wine, or liquor? No : //

Gum, breath mints, lozenges or cough drops, or other cough or cold remedies? No : //

Antacids, laxatives, or anti-diarrheals? No : //

Dietary supplements such as vitamins and minerals? [Include multivitamins and single nutrient supplements.] No : //

Fasting 15 Hours 26 Minutes

Fasting Questionnaire – Spanish

Phlebotomy

File View Utilities Reports Window Help

Phlebotomy: Stand:410 Session:410500 10/07/2004 08:30 am - 12:30 pm

SP ID: 306325 Name: KAIGA, NEWTON Age: 13 years Gender: Male Date: 12/09/2008 Time: 12:54 PM

Fasting Questionnaire

¿Cuándo fue la última vez que comió o tomó alguna cosa aparte de agua sola? No incluya soda de dieta o café o té solo endulzado con endulzadores artificiales como Sweet'N Low, NutraSweet, Equal o Splenda. 09:30 PM 12/08/2008

Ha tomado o comido algo de lo siguiente ¿desde ayer a las 9:30 de la tarde?

¿Café o té con crema o azúcar? [Incluya leche o cremas que no sean productos lácteos.] No : //

¿Alcohol, tal como cerveza, vino o licor? No : //

¿Chicle, mentas para el aliento, tabletas o pastillas para la tos, u otra medicina para la tos o el resfriado? No : //

¿Antiácidos, laxantes, o antidiarreicos? No : //

¿Suplementos para la dieta tales como vitaminas y minerales? [Incluya multivitaminas y suplementos nutritivos individuales.] No : //

Fasting 15 Hours 27 Minutes

of 4

Urine Specimen Collection and Processing

4

4.1 Introduction

The purpose of urine collection and processing is to collect sufficient urine from participants aged 3 years and older to be able to: (1) collect a date, time, and volume of urine collection for analysis of urine flow rate; (2) perform a pregnancy test on selected females aged 8 to 11 years and all females aged 12 to 59 years to exclude pregnant participants from other components that could put the participant at risk; (3) aliquot urine into vessels for storage and transport to multiple government and contract laboratories for analysis; and (4) aliquot urine into a vessel for future studies.

Collect a urine specimen from all study participants (SPs) aged 3 years and older. The volume of urine required to complete each SP's protocol is displayed in the urine collection module. Place the urine container on the Mettler Toledo scale and then scan the label on the barcode. The weight is converted to volume and transmitted to the urine collection module in the Integrated Survey Information System (ISIS). Visually compare the volume in the urine container to the volume displayed in the urine collection screen. Accept or correct the weight. Perform the pregnancy test if indicated, process the urine protocol, and store the vessels.

The mobile examination center (MEC) coordinator instructs each SP aged 6 years and older to provide a urine sample as soon as possible when he or she enters the MEC. Ideally, this sample would be collected at the same time that the SP changes into the exam outfit. If the SP cannot provide a urine sample at that time, the coordinator offers the SP a glass of water and asks the SP to provide a sample as soon as possible. The SP is instructed to collect a complete void by emptying the bladder into the urine collection cup. The coordinator, assistant coordinator, or any MEC staff member is responsible for transporting the urine specimen to the laboratory.

The coordinator explains the following instructions to the subject before urine collection:

- It is important to collect ALL urine by COMPLETELY emptying your bladder into the cup.
- Wash your hands with soap and water.

- Take the cap off the cup.
- Urinate directly into the cup until it is full or until you have finished urinating.
- DO NOT OVERFILL THE CUP.
- The inside of the cup and cap should not touch or come into contact with any part of your body, clothing, or external surfaces.
- Recap the collection cup and seal tightly.
- Place the filled urine cup on the top of the toilet tank lid.
- Please remember to wash your hands.

The health techs, MEC managers, or other specially trained personnel will introduce the 3- to 5-year-old urine collection to the parent or guardian, who will help the child collect the urine. Detailed instruction will be provided by the MEC staff, who will also transport the specimen to the lab.

- The MEC staff will prep the toilet for the 3- to 5-year-olds.
- The MEC staff will place the urine collection container on the toilet and lower the lid for the SP.
- The MEC staff will explain not to touch the inside of the container, not to put toilet paper inside the collection container, and to have the parent/guardian hold the child over the collection container.
- The MEC staff will also instruct the parent/guardian to gently place the lid on the container and leave it in the toilet when you're finished.
- The MEC staff will transport the specimen to the lab.

If an elderly SP, disabled person or obese female wishes to use the same collection container that is utilized for the 3- to 5-year-olds in place of the urine cup, this request will be accommodated along with the appropriate instruction for its use. An adjustment for the container tare weight will need to be made at the time the urine volume is recorded.

4.2 Supplies

The supplies needed for urine collection and urine processing and storage are listed in Exhibits 4-1 and 4-2.

Exhibit 4-1. Urine collection equipment

Blue scale carrying case
Mettler Toledo PL602E Scale Cone protector Weigh pan One Troemner 100-g weight (start of stand QC) Two Troemner 300-g weights (start of stand QC)
Care Pac M
Cleaning cloth Two gloves Weight transfer tool for 500-g weight Weight transfer forceps for 20-g weight Cleaning brush One Ohaus 500-g weight (daily QC) One Ohaus 20-g weight (daily QC)
Clear acrylic scale cover
Barcode scanner

Exhibit 4-2. Urine collection supplies – urine processing and storage

2-ml cryovial sterile	cardboard box, 2.0-inch with 9 x 9 grid
5-ml cryovial sterile; Five-O screwcap	cardboard box, 5.25" x 5.25" with foam insert
5-ml cryovial sterile	cardboard box, 3.0-inch with 9 x 9 grid
10-mL Vial CryoPro VWR screwcap	cardboard box, 3.0-inch with 5 x 5 grid - White
10-mL Vial CryoPro VWR screwcap - WITH ADDITIVE (Urine/Mercury)	Cube rack – 4-way flipper rack
3.5-ml Starstedt Transfer pipette	Kimwipes
15-ml VWR narrow stem, large bulb disposable transfer pipette	Nonsterile, powder-free, gloves—small, medium, large
Bench Kote paper	Windex for scale cleaning

4.3 Urine Flow Rate Background

The NHANES protocol includes many measures of environmental toxicants or their metabolites in urine. It is difficult to quantify the level of exposure based on measurements in urine because concentrations will vary by the amount of urine produced. Currently, NHANES urine measurements are adjusted by the urinary creatinine concentration to account for variations in urinary dilution. However, creatinine excretion into the urine varies by many factors other than the urinary dilution (e.g., age, gender, muscle mass, and diet). Also, the amount of toxicant excreted in a

24-hour period is often needed to quantify exposures for risk and exposure assessment purposes. Ideally, this requires 24-hour urine collections to quantify. However, it is possible to estimate the mass of analyte excreted in the urine in a 24-hour period by estimating the urine flow for the spot urine specimen collection (i.e., equivalent to a single urine specimen as collected in the current NHANES protocol).

The date and time of last urine void, along with the volume of the urine specimen and the date and time of urine collection captured during urine collection, will provide NCHS with a measurement of urine flow rate. These items are captured during the SP's visit to the MEC. All SPs aged 3 years and older will be eligible for urine flow rate. Urine specimen volume and date and time of collection will be captured only on SPs who submit a urine specimen.

The MEC appointment reminder letter will include the reminder "Before arriving at the exam center, please make a note of the time you last went to the bathroom and urinated (peed). Please write the time on the appointment card you were given. You will be asked for this time when you get to the exam center," and will provide a space for the SP to write a response. When the SP arrives at the MEC, the coordinator will prompt the SP to write down the time of his or her last urine void on the verification form. The coordinator will record this time. If there is any discrepancy between the time on the reminder letter and the time reported at the MEC, the coordinator should use the time reported at the MEC.

4.4 Using the Scale for Urine Collection

The Mettler Toledo scale is located in the clean laboratory area near workstation 3. Check to make sure the scale's weighing pan is free of any objects or debris. Turn on the Mettler Toledo scale by pressing the "On" button. After the display briefly lights up all segments, the LED will display "0.0 g." This indicates that the scale is ready to weigh samples. The scale should be used only when set to measure in grams. Cover the scale with the clear acrylic scale cover until a sample is available for weighing. The scale must be leveled before using the scale for reporting results and performing QC. The leveling bubble is located in the right rear corner of the scale. The bubble must be leveled so that it sits in the center of the window. See diagram below.



Ensure that computer workstation 3 (Urine/Sink) is turned on and a technician is logged into the Laboratory application. Open the Urine Scale application by double-clicking on the Urine Scale icon on the desktop. The Urine Scale icon looks like this:



The Urine Scale application icon will appear in the system tray, similar to the Coulter application. This application captures data from the scale and logs it into the database. The Urine Scale application must be opened and in the system tray in order to capture any urine collection readings from the scale.



If the LED reads “MT Green,” the scale is in sleep mode. Touching the scale pan, placing a urine container on the scale pan, or clicking on the scale icon will bring the scale to a ready state.

If the urine collection cup appears to contain < 1 mL, do NOT weigh the cup; see section 4.5.1.

Place the urine collection cup on the Mettler Toledo scale. Cover the scale with the clear box cover to protect the scale from draft. Look at the scale’s LED display. In the bottom left corner of the display, the stability detector “o” will appear briefly. Once the stability indicator goes away, the weight result is valid. Scan the barcode on the cup using the barcode scanner next to the scale.



Look at the scale's LED screen to ensure that the SP ID displays. Checking for the SP ID display on the LED screen is verification that the collection was recorded in the database.

Note: the LED display does not show the first digit of the SP ID.

4.5 Document Urine Collection

Once a urine sample has been scanned in, the urine collection (UC) circle on the heads-up screen for that SP will turn a solid blue ● for Yes the quantity is sufficient or a blue bullseye ⊙ for quantity not sufficient (QNS).

For SPs age 6 years or older, the label on the urine container reads CC1, which indicates collection cup 1 or the 500-ml cup. For SPs age 3-5 years, the label on the urine container will read CC2, which indicates collection cup 2.

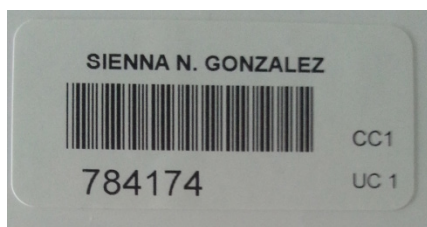

Verification of Urine Collection

To verify a urine sample, locate the correct SP ID and Name on the Lab Subsystem display; the row will have a blue UC circle. The blue color indicates that there is a urine sample in the lab ready to be verified by the laboratory technician.

SP ID	Sample ID	Status	Type	Gender	Age	Name	Process Status						HPV	
							UC	U	P	CB	B	PC	F	M
329869	329869	SC	P	F	12	HOWARD, CHARLES S	●	○	○	○	○	○	-	-
386827	386827	SC	P	F	26	DEEGAN, DOUG O	⊕	○	○	○	○	-	○	-
416714	416714	SC	P	F	16	BAILEY, ANTHONY J	○	○	○	○	○	○	○	-
499508	499508	SC	P	F	5	DEEGAN, MARK	○	○	-	○	○	-	-	-
525757	525757	SC	P	M	3	LAST NAME, PAT M	○	○	-	○	○	-	-	-
745052	745052	SC	P	F	12	TIM, SP FIRST NAME M	○	○	○	○	○	-	-	-
767995	767995	SC	P	F	39	NAME, LAST M	○	○	○	○	○	-	○	-
836040	836040	SC	P	M	54	TORRES, LUCAS T	○	○	-	○	○	-	-	○
849425	849425	SC	P	F	16	CAMPBELL, VINNIE N	○	○	○	○	○	○	○	-
919919	919919	SC	P	M	57	PAYNE, IMA L	○	○	-	○	○	○	-	○

1. Select an SP with a blue UC circle and access the Urine Collection module. Right-click on the blue circle under the UC column on the heads-up screen to access the Urine Collection module.
2. Left-click on “Urine Collection” on the module pop-up menu. The urine collection verification screen will open.

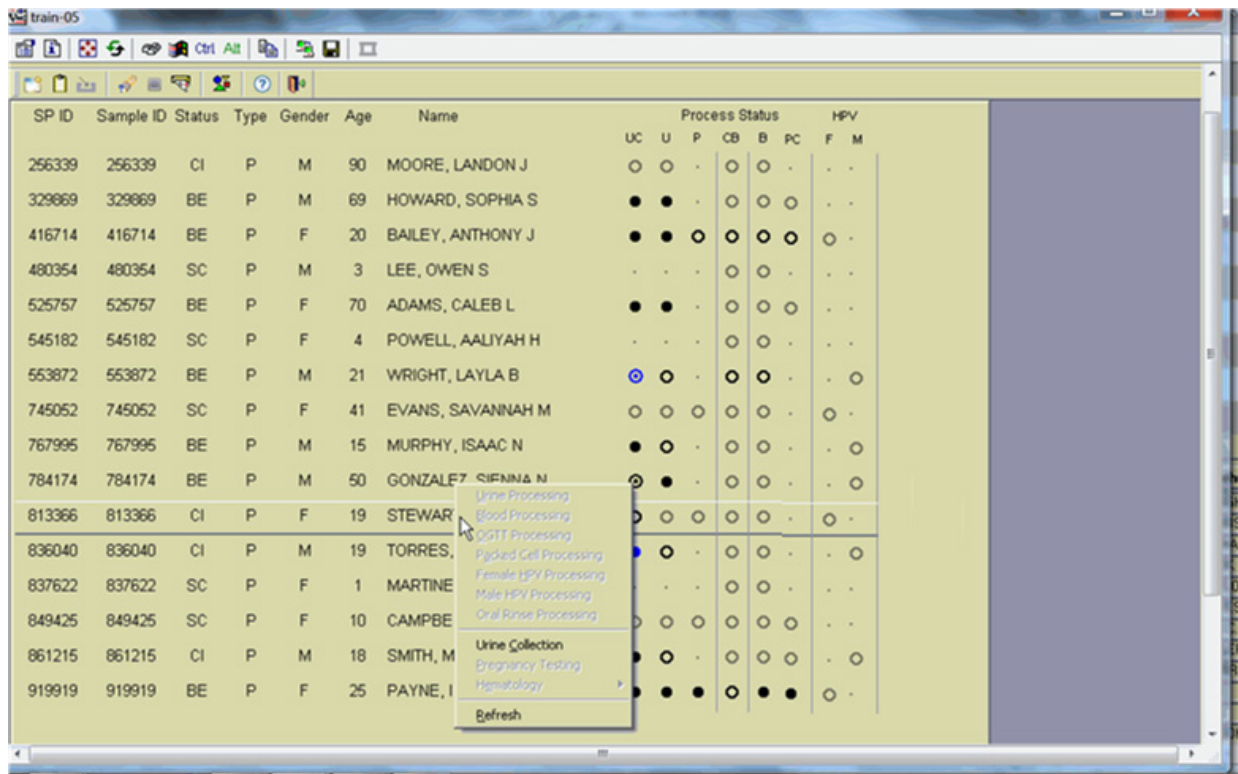

The urine collection verification window displays an upper and lower section. The top of the urine collection window contains:

- columns for the SP ID, person name (last, first), gender, and age,
- rows for checked-in SPs are indicated in black,
- SPs who have not checked into the MEC session are gray, and
- SPs who have a urine collection ready for verification display in blue.

3. Use the scroll bar to view all SPs scheduled into the session.

The screenshot shows a software window titled "Urine Collection Verification: 430420". The window is divided into two main sections. The top section is a table listing patient information. The bottom section provides a detailed view for the selected patient, including collection details and summary statistics.

Sp ID	Sample ID	Name	Gender	Age
220901	220901	RUSSELL_2, JACK	M	25
224633	224633	SMITH_2, TYLER	M	46
238763	238763	WALLACE_3, MILDRED	F	73
240491	240491	WALLACE_3, JILL	F	39
244445	244445	NELSON_2, JENNY	F	36
248212	248212	TAYLOR_2, BEN	M	28
251401	251401	NELSON_3, HOWARD	M	36

SP ID: 220901 NAME: RUSSELL_2, JACK AGE: 25 Gender: M

Collection	Volume (mL)	Collection Date/Time	Status	Comment Code	Verified
1	203	12/19/2008 04:16 PM	Yes	(none)	<input type="checkbox"/>

Total Collected: 203
Total Required: 55

Buttons: Save, New Collection, OK, Cancel

4. Left-click on the row for the SP ID (blue text) to be verified. The lower half of the screen displays the following information:
 - Collection attempt.
 - Volume (whole ml)
 - Collection date and time
 - Status of the urine
 - Comment code
 - Verification check box
 - Total collected amount (sum in ml of all urine collections)

If the SP has submitted a urine collection that has been weighed and scanned into the database, the volume, collection status, and collection date and time will automatically display in the lower portion of the Urine Collection screen. If the collection did not meet the minimum requirement for the protocol, the system will automatically select “QNS” with the comment code “quantity not sufficient.” A QNS result immediately notifies the coordinator to prompt for an additional urine collection. A second instance of urine collection for the first QNS sample or third instance of urine collection for the second QNS sample will appear below the current sample for SPs age 6 years or older. For SPs age 3-5 years, if the first instance of urine collection is QNS, a second instance will appear. If the quantity of urine collection does meet the requirement of the urine protocol, the system will automatically select “Yes” and no additional collections will appear.

Evaluate the quantity of urine received in the laboratory.

Sp ID	Sample ID	Name	Gender	Age
300780	300780	MARTIN_5, JOE	M	46
304240	304240	BUTLER_5, CATHY	F	22
304755	304755	MARTIN_7, THOMAS	M	22
305504	305504	HOLLAND_6, LISA	F	30
306771	306771	MILLER_3, PATTY	F	50
306998	306998	FULTON_6, JEREMY	M	54
307322	307322	ESTRADA_4, JOSE	M	25

Collection	Volume (mL)	Collection Date/Time	Status	Comment Code	Verified
1	26	11/04/2009 10:46 AM	QNS	quantity not suffic	<input type="checkbox"/>
2			(none)	(none)	<input type="checkbox"/>

Total Collected: 26
Total Required: 55

The application estimates that one gram of urine is equal to one ml of urine and records the weight of the urine in whole numbers following standard rounding procedures. The application will automatically assign the comment code “quantity not sufficient” (QNS) for all urine collections that are calculated to be QNS. The application uses the total collected volume and compares it to the total required volume to determine the QNS status. The laboratory technologist may also manually assign a QNS status to all samples that are deemed QNS during the verification process.

A “QNS” result automatically turns the lab progress bar yellow on the Coordinator screen. This yellow progress bar alerts the coordinator, who then asks SPs age 6 years or older to provide an additional urine specimen and asks the parent/guardian of the 3- to 5-year-olds if the child could

drink additional water **or juice** so that another urine collection attempt might be possible before the participant leaves the MEC.

4.5.1 Quantity Not Sufficient (QNS) Urines

Store all QNS urines at room temperature. If the SP has voided <1.0 ml, the lab will ask the coordinator for a re-collection of Urine Collection (UC) 1. Do not record any results for this urine instance. Discard this sample and wait for a new UC 1. An exception to this is in the instance of a female SP requiring a pregnancy test who provides <1 ml. In this instance, take the following steps to enable pregnancy testing for components that are blocked until a negative pregnancy test result is reported.

If < 1mL for UC1 (female 8+ to allow pregnancy test),

- Scan SP ID for UC1 but do NOT weigh
- Select Comment “< 1 mL of urine received”
- Status changes to QNS
- Volume = BLANK (Disabled)

When additional urine is obtained or collected and it's enough to fill the SPs profile, pool the urine into the most recently collected cup (the cup with the highest urine collection instance number on the cup label), mix, and process. Do not enter a result until urine arrives in the laboratory. At the end of each session, review the results for each SP. Enter “No” in the result field for all SPs who have not produced a urine sample. Record a result other than “none” for all SPs.

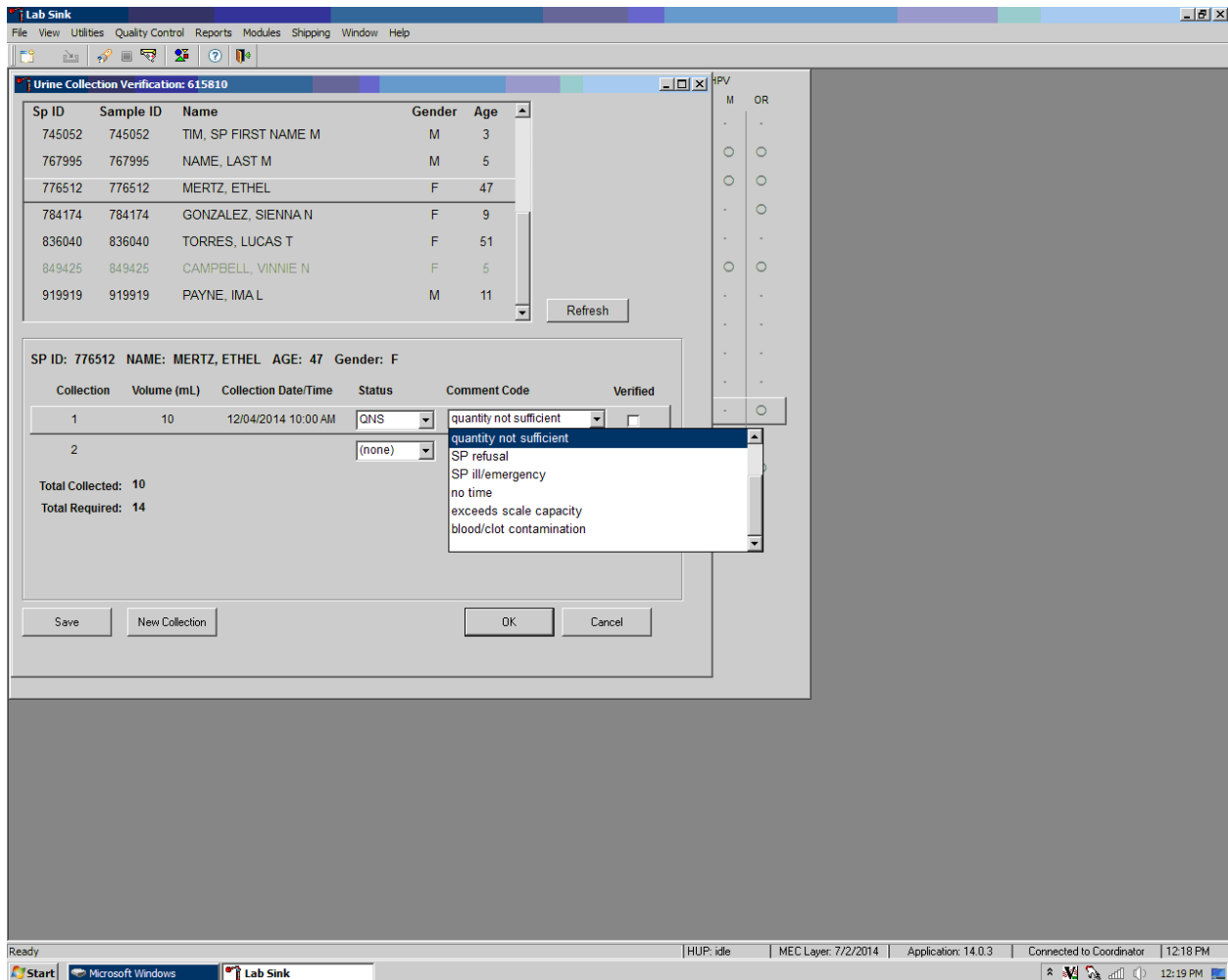

The urine collection cup capacity may contain a sample that weighs more than the scale weight capacity of 610 grams. Look at the scale display for full specimens. If the scale displays dashes when it should display a weight, the reading is over the scale limit: $\Gamma - - - - \Gamma$. When the barcode for the sample is scanned in, instead of the barcode number displaying on the LCD screen, the words “over Lmt” display.

When the scale is over limit it does not transmit data to the ISIS application. Manually enter the volume 610 ml in the volume column.

The screenshot shows a software window titled "Lab Subsystem: Stand:615 Session:615811 11/15/2010 01:30 pm - 05:30 pm". The main window is "Urine Collection Verification: 615811". It contains a table of specimens:

Sp ID	Sample ID	Name	Gender	Age
784174	784174	SMITH, 42F N	F	42
813366	813366	JOHNSON, 30F J	F	30
849425	849425	JOHNSON, 22M N	M	22
861215	861215	SMITH, 47M S	M	47
919919	919919	JOHNSON, 20F L	F	20
932438	932438	JOHNSON, 16F L	F	16
947094	947094	SMITH, 40F L	F	40

Below the table is a "Refresh" button. The selected specimen (SP ID: 932438) details are shown below:

SP ID: 932438 NAME: JOHNSON, 16F L AGE: 16 Gender: F

Collection	Volume (mL)	Collection Date/Time	Status	Comment Code	Verified
1	400		(none)	(none)	<input type="checkbox"/>

Total Collected: [blank]
Total Required: 62

A dialog box titled "Subtract Tare Value" is open, asking: "Would you like to subtract the tare value of 48." with "Yes" and "No" buttons.

At the bottom of the form are buttons: "Save", "New Collection", "OK", and "Cancel".

The system tray at the bottom shows: Ready | HUP: idle | MEC Layer: 10/8/2010 | Application: 11.0.0 | Connected to Coordinator | 04:32 PM

For SPs 6 years or older, press Tab to move to the Collection Date/Time field. The application will ask "Would you like to subtract the tare value of 48?" Select OK. Enter the date and time of the specimen collection.

Press Tab to continue on to the Status field. The tare weight for SPs 3 to 5 years old is 64.

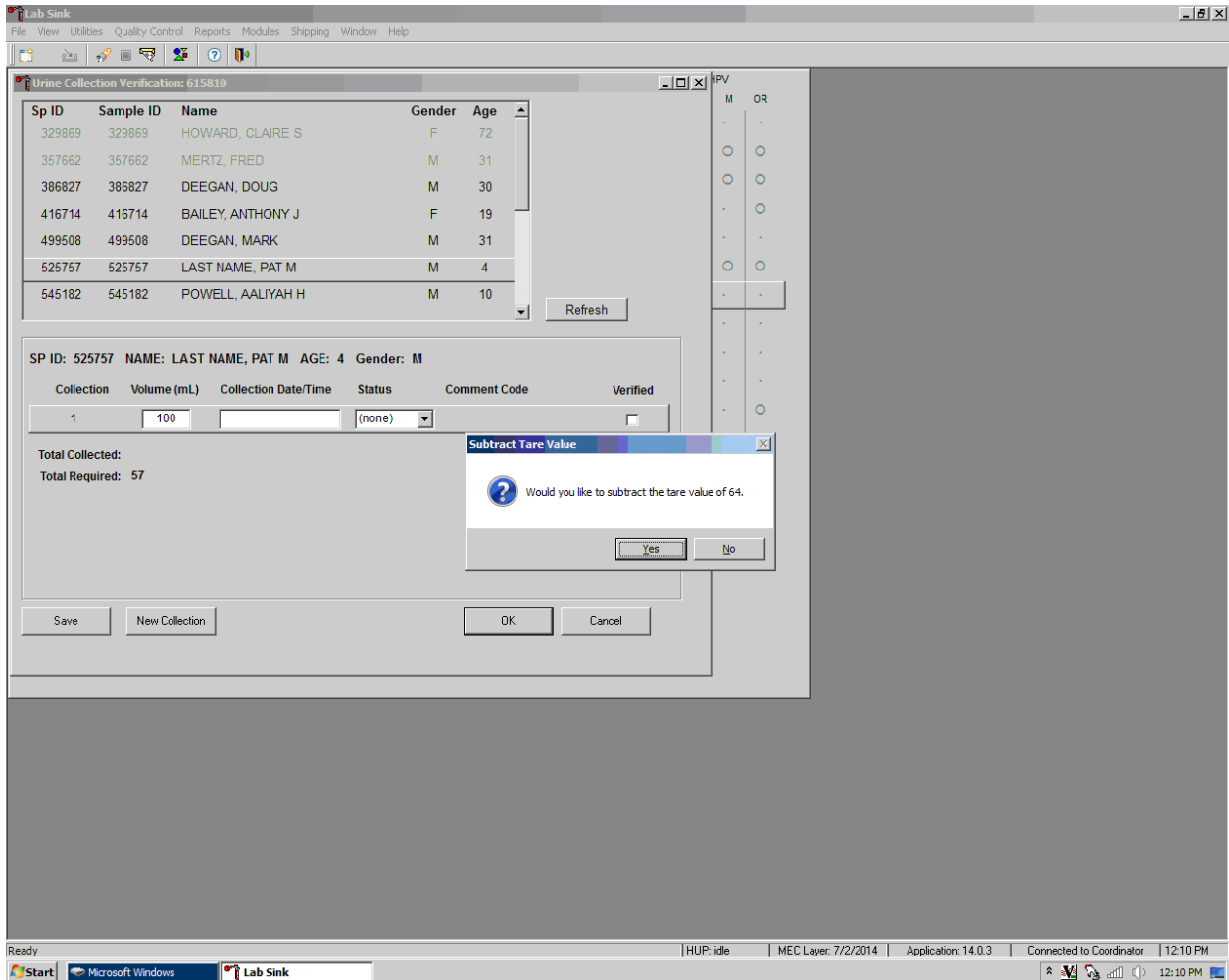

Sp ID	Sample ID	Name	Gender	Age
220901	220901	RUSSELL_2, JACK	M	25
224633	224633	SMITH_2, TYLER	M	46
238763	238763	WALLACE_3, MILDRED	F	73
240491	240491	WALLACE_3, JILL	F	39
244445	244445	NELSON_2, JENNY	F	36
248212	248212	TAYLOR_2, BEN	M	28
251401	251401	NELSON_3, HOWARD	M	36

SP ID: 220901 NAME: RUSSELL_2, JACK AGE: 25 Gender: M

Collection	Volume (mL)	Collection Date/Time	Status	Comment Code	Verified
1	556	12/19/2008 03:30 PM	Yes	(none)	<input type="checkbox"/>

Total Collected: 556
Total Required: 55

Buttons: Save, New Collection, OK, Cancel

Record urine collections that exceed the scale as “Yes.” To mark the urine collection status, direct the mouse arrow to the drop-down list, click to display the different status, and select Yes by clicking once on Yes with the mouse arrow. Use the Tab key to proceed on to the Comment Code field.

Record a comment for sufficient urine collections if the weight of the urine exceeds the scale weight capacity of 610 grams.

Lab Sink

File View Utilities Reports Modules Shipping Window Help

Urine Collection Verification: 430940

Sp ID	Sample ID	Name	Gender	Age
300780	300780	MARTIN_5, JOE	M	46
304240	304240	BUTLER_5, CATHY	F	22
304755	304755	MARTIN_7, THOMAS	M	22
305504	305504	HOLLAND_6, LISA	F	30
306771	306771	MILLER_3, PATTY	F	50
306998	306998	FULTON_6, JEREMY	M	54
307322	307322	ESTRADA_4, JOSE	M	25

Refresh

SP ID: 304240 NAME: BUTLER_5, CATHY AGE: 22 Gender: F

Collection	Volume (mL)	Collection Date/Time	Status	Comment Code	Verified
1	562	11/04/2009 11:00 AM	Yes	(none)	<input type="checkbox"/>

Total Collected: 562
Total Required: 49

- quantity not sufficient
- SP refusal
- SP ill/emergency
- no time
- exceeds scale capacity
- blood/clot contamination

To record a comment, direct the mouse arrow to the drop-down list, click to display the Comment Codes, and select “exceeds scale capacity” from the drop-down list. Alternatively, use the up and down keyboard arrows to scroll through the choices or type the first letter of the desired comment code and, when the correct choice is highlighted, left-click.

Visually evaluate the urine sample for blood contamination. If the sample is contaminated with blood, record the “blood/clot contamination” comment for both sufficient and QNS urine collections.

Lab Sink

File View Utilities Reports Modules Shipping Window Help

Urine Collection Verification: 430940

Sp ID	Sample ID	Name	Gender	Age
300780	300780	MARTIN_5, JOE	M	46
304240	304240	BUTLER_5, CATHY	F	22
304755	304755	MARTIN_7, THOMAS	M	22
305504	305504	HOLLAND_6, LISA	F	30
306771	306771	MILLER_3, PATTY	F	50
306998	306998	FULTON_6, JEREMY	M	54
307322	307322	ESTRADA_4, JOSE	M	25

Refresh

SP ID: 304240 NAME: BUTLER_5, CATHY AGE: 22 Gender: F

Collection	Volume (mL)	Collection Date/Time	Status	Comment Code	Verified
1	562	11/04/2009 11:00 AM	Yes	(none)	<input type="checkbox"/>

Total Collected: 562
Total Required: 49

- quantity not sufficient
- SP refusal
- SP ill/emergency
- no time
- exceeds scale capacity
- blood/clot contamination

To record a comment, direct the mouse arrow to the drop-down list, click to display the Comment Codes, and select “exceeds scale capacity” from the drop-down list. Alternatively, use the up and down keyboard arrows to scroll through the choices or type the first letter of the desired comment code and, when the correct choice is highlighted, left-click.

Visually evaluate the urine sample for blood contamination. If the sample is contaminated with blood, record the “blood/clot contamination” comment for both sufficient and QNS urine collections.

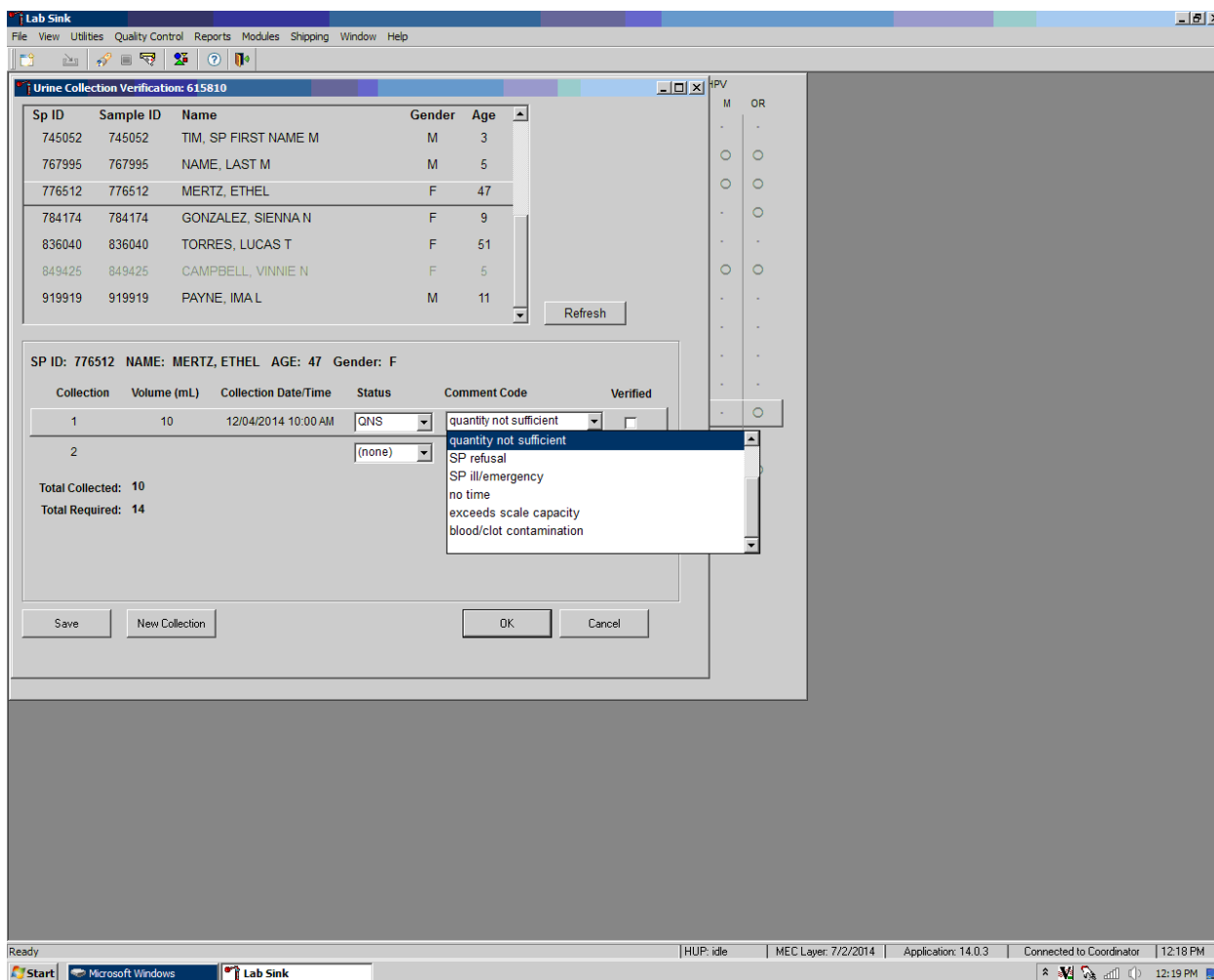

The “blood/clot contamination” comment should supersede the “quantity not sufficient” comment code when blood is present in a QNS specimen. To record a comment, direct the mouse arrow to the drop-down list, click to display the comment codes, and select “blood/clot contamination” from the drop-down list. Alternatively, use the up and down keyboard arrows to scroll through the choices or type the first letter of the desired comment code and, when the correct choice is highlighted, left-click.

Record a comment for all insufficient urine collections. The laboratory application will automatically assign the comment code “quantity not sufficient” for all urine collections that are calculated as QNS by the scale application. The laboratory technician may also assign this comment code to all samples that are changed to QNS during the verification process.

Urine Collection Verification: 430420

Sp ID	Sample ID	Name	Gender	Age
220901	220901	RUSSELL_2, JACK	M	25
224633	224633	SMITH_2, TYLER	M	46
238763	238763	WALLACE_3, MILDRED	F	73
240491	240491	WALLACE_3, JILL	F	39
244445	244445	NELSON_2, JENNY	F	36
248212	248212	TAYLOR_2, BEN	M	28
251401	251401	NELSON_3, HOWARD	M	36

SP ID: 244445 NAME: NELSON_2, JENNY AGE: 36 Gender: F

Collection	Volume (mL)	Collection Date/Time	Status	Comment Code	Verified
1	12	12/19/2008 04:13 PM	QNS	quantity not suffic	<input type="checkbox"/>
2			(none)	(none)	<input type="checkbox"/>

Total Collected: 12
Total Required: 56

Save New Collection OK Cancel

To record a comment, direct the mouse arrow to the drop-down list, click to display the comment codes, and select the most appropriate choice.

Exhibit 4-3. Comment codes for insufficient urine collection

Comment Code	Use when:
Communication problem	SP is unable to understand and follow instructions for the component due to language, cognitive impairment, or other problems, and is unable to complete the test.
SP unable to comply	SP has a physical limitation that prohibits him or her from producing a urine specimen or the SP is unable to produce urine during the session.
Quantity not sufficient	The quantity of urine is insufficient to process any or all urine vessel(s).
SP refusal	SP refuses to provide urine during the session.
SP ill/emergency	Not applicable.
No time	Not applicable.
Exceeds scale capacity	The weight of the urine exceeds the scale weight capacity of 610 grams.
Blood/clot contamination	Blood or clots are present in the urine and may affect the volume capture.

Verify the results of the urine collection. To verify, direct the mouse arrow to the “Verified” check box. Left-click on the check box and a checkmark will appear in the box. Verifying the results will save them to the database.

Urine Collection Verification: 430420

Sp ID	Sample ID	Name	Gender	Age
220901	220901	RUSSELL_2, JACK	M	25
224633	224633	SMITH_2, TYLER	M	46
238763	238763	WALLACE_3, MILDRED	F	73
240491	240491	WALLACE_3, JILL	F	39
244445	244445	NELSON_2, JENNY	F	36
248212	248212	TAYLOR_2, BEN	M	28
251401	251401	NELSON_3, HOWARD	M	36

SP ID: 220901 NAME: RUSSELL_2, JACK AGE: 25 Gender: M

Collection	Volume (mL)	Collection Date/Time	Status	Comment Code	Verified
1	556	12/19/2008 03:30 PM	Yes	exceeds scale ca	<input checked="" type="checkbox"/>

Total Collected: 556
Total Required: 55

Save New Collection OK Cancel

Continue recording and verifying urine collection results as specimens are received in the laboratory. Use the scroll bar to view all SPs in the top part of the Urine Collection screen. SPs who need their urine verified will appear in blue on the top screen.

An SP will be prompted for additional urine only if (1) the total of his or her urine collection was insufficient to meet the SP's protocol requirement and (2) the SP has submitted less than three collection samples. The Urine Collection screen will display up to three instances of urine collection for SPs 6+ and two instances for SPs 3-5 years old. Urine collection is complete regardless of the amount of urine collected after three attempts. When urine is collected as QNS, a message is sent to the coordinator to prompt the SP for more urine.

Urine Collection Verification: 430420

Sp ID	Sample ID	Name	Gender	Age
220901	220901	RUSSELL_2, JACK	M	25
224633	224633	SMITH_2, TYLER	M	46
238763	238763	WALLACE_3, MILDRED	F	73
240491	240491	WALLACE_3, JILL	F	39
244445	244445	NELSON_2, JENNY	F	36
248212	248212	TAYLOR_2, BEN	M	28
251401	251401	NELSON_3, HOWARD	M	36

SP ID: 244445 NAME: NELSON_2, JENNY AGE: 36 Gender: F

Collection	Volume (mL)	Collection Date/Time	Status	Comment Code	Verified
1	12	12/19/2008 04:13 PM	QNS	quantity not suffic	<input type="checkbox"/>
2			(none)	(none)	<input type="checkbox"/>

Total Collected: 12
Total Required: 56

Save New Collection OK Cancel

If the urine collection is the first or second collection and the status is QNS, a record for the second and third instances of urine collection will automatically be added by the Laboratory application. Second and third collections will display as empty rows after the last urine collection. The instance number is displayed under the Collection column.

Verify the urine collection by checking the “Verified” box. Use “Save” to save changes or select the  in the upper right corner to exit out of the Urine Collection screen.

Once a urine collection has been recorded for an SP, the circle on the heads-up screen will turn black (◉ for QNS or ● for Yes). A black urine collection circle indicates that no additional action needs to be taken on that SP for urine collection at that time.

SP ID	Sample ID	Status	Type	Gender	Age	Name	Process Status						HPV	
							UC	U	P	CB	B	PC	F	M
329869	329869	SC	P	F	12	HOWARD, CHARLES S	<input checked="" type="radio"/>	<input type="radio"/>	<input type="radio"/>	<input type="radio"/>	<input type="radio"/>	<input type="radio"/>	<input type="radio"/>	<input type="radio"/>
386827	386827	SC	P	F	26	DEEGAN, DOUG O	<input checked="" type="radio"/>	<input type="radio"/>	<input type="radio"/>	<input type="radio"/>	<input type="radio"/>	<input type="radio"/>	<input type="radio"/>	<input type="radio"/>
416714	416714	SC	P	F	16	BAILEY, ANTHONY J	<input type="radio"/>	<input type="radio"/>	<input type="radio"/>	<input type="radio"/>	<input type="radio"/>	<input type="radio"/>	<input type="radio"/>	<input type="radio"/>
499508	499508	SC	P	F	5	DEEGAN, MARK	<input type="radio"/>	<input type="radio"/>	<input type="radio"/>	<input type="radio"/>	<input type="radio"/>	<input type="radio"/>	<input type="radio"/>	<input type="radio"/>
525757	525757	SC	P	M	3	LAST NAME, PAT M	<input type="radio"/>	<input type="radio"/>	<input type="radio"/>	<input type="radio"/>	<input type="radio"/>	<input type="radio"/>	<input type="radio"/>	<input type="radio"/>
745052	745052	SC	P	F	12	TIM, SP FIRST NAME M	<input type="radio"/>	<input type="radio"/>	<input type="radio"/>	<input type="radio"/>	<input type="radio"/>	<input type="radio"/>	<input type="radio"/>	<input type="radio"/>
767995	767995	SC	P	F	39	NAME, LAST M	<input type="radio"/>	<input type="radio"/>	<input type="radio"/>	<input type="radio"/>	<input type="radio"/>	<input type="radio"/>	<input type="radio"/>	<input type="radio"/>
836040	836040	SC	P	M	54	TORRES, LUCAS T	<input type="radio"/>	<input type="radio"/>	<input type="radio"/>	<input type="radio"/>	<input type="radio"/>	<input type="radio"/>	<input type="radio"/>	<input type="radio"/>
849425	849425	SC	P	F	16	CAMPBELL, VINNIE N	<input type="radio"/>	<input type="radio"/>	<input type="radio"/>	<input type="radio"/>	<input type="radio"/>	<input type="radio"/>	<input type="radio"/>	<input type="radio"/>
919919	919919	SC	P	M	57	PAYNE, IMA L	<input type="radio"/>	<input type="radio"/>	<input type="radio"/>	<input type="radio"/>	<input type="radio"/>	<input type="radio"/>	<input type="radio"/>	<input type="radio"/>

4.6 Manually Documenting Urine Collection

4.6.1 Manually Document Urine Collection With Barcode Scanning

The technician can manually record the volume, status, and collection date and time in the urine collection module within the laboratory application. Place the urine collection cup on the scale and cover with the clear acrylic scale cover. Scan the barcode on the urine cup.

NOTE: Use this function when the interface between the scale and the laboratory system is not functioning properly.

Open the Urine Collection screen from the heads-up as described in Section 2.2. The urine collection window displays. At this point, the technician can modify the volume of the urine and the collection date/time.

To manually adjust the Volume (ml), direct the mouse arrow to the text box under the Volume (ml) column. Double-click to open boxes for modification and then click on the text box to enable the cursor in the box. Make changes using the number pad on the keyboard. Once any necessary adjustments have been made, direct the mouse arrow to the box under the Collection Date/Time column or press the Tab key. A prompt will pop up, asking if you would like to subtract the weight of the cup. If the volume of the sample was transmitted from the scale and you have made a manual adjustment to that reading, select “No.”

In the Collection Date/Time box, right-click on the text box to enable the cursor inside the box. Adjust the date and time by entering the date in the format “MMDDYYYY ##:##” using the number pad on the keyboard. Adjust “am/pm” by using the up or down arrows. Once any necessary adjustments have been made, direct the mouse arrow to the box under the Status column or press the Tab key.

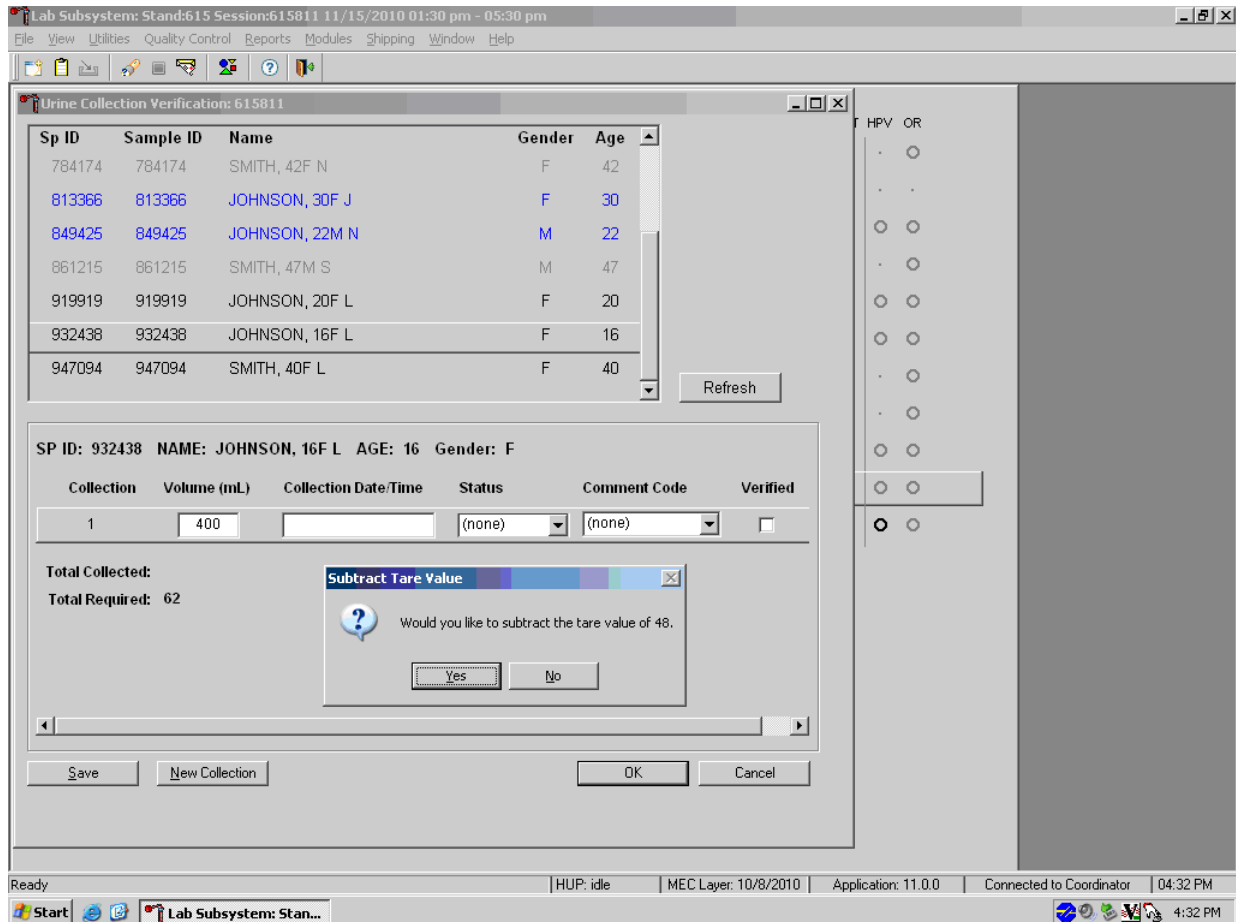

Continue to enter the collection date/time, selecting the appropriate urine collection status and a comment code if applicable. Verify the urine collection by checking the “Verified” box.

If the urine collection is the first or second collection and is QNS, second and third instances of urine collection may be added by using the “New Collection” button at the bottom of the screen.



Add a second or third collection only if the previous collection was QNS. Enter the second or third urine collection results when the sample is submitted to the MEC laboratory. Do this by typing in the boxes for volume and collection date/time and then selecting the appropriate urine collection status and a comment code if applicable.

Verify the urine collection by checking the “Verified” box. Use “Save” to save changes or select the  in the upper right corner to exit out of the Urine Collection screen.

4.6.2 Manually Document Urine Collection Without Barcode Scanning

If the connection between the scale and workstation 3 is down, the technician can manually record the volume, status, and collection date and time in the urine collection module within the laboratory application. Place the urine collection cup on the scale and cover with the clear acrylic scale cover. Note the weight reading from the LCD.

Open the Urine Collection screen from the heads-up as described in Section 2.2. The urine collection window displays. Double-click in the area underneath Volume or Collection Date/Time to open the boxes where the values can be entered. Enter the urine collection results by typing in the weight reading from the scale’s display in the box for volume.

Lab Subsystem: Stand:615 Session:615811 11/15/2010 01:30 pm - 05:30 pm

File View Utilities Quality Control Reports Modules Shipping Window Help

Urine Collection Verification: 615811

Sp ID	Sample ID	Name	Gender	Age
784174	784174	SMITH, 42F N	F	42
813366	813366	JOHNSON, 30F J	F	30
849425	849425	JOHNSON, 22M N	M	22
861215	861215	SMITH, 47M S	M	47
919919	919919	JOHNSON, 20F L	F	20
932438	932438	JOHNSON, 16F L	F	16
947094	947094	SMITH, 40F L	F	40

Refresh

SP ID: 932438 NAME: JOHNSON, 16F L AGE: 16 Gender: F

Collection	Volume (mL)	Collection Date/Time	Status	Comment Code	Verified
1			(none)	(none)	<input type="checkbox"/>

Total Collected:
Total Required: 62

Save New Collection OK Cancel

HPV OR

Ready | HUP: idle | MEC Layer: 10/8/2010 | Application: 11.0.0 | Connected to Coordinator | 04:35 PM

Start Lab Subsystem: Stan... 4:36 PM

If the next box is selected by pressing the Tab key or selected by the mouse, a prompt will pop up asking if you would like to subtract the weight of the urine cup from the result entered. Select “Yes.”

Urine Collection Verification: 615811

Sp ID	Sample ID	Name	Gender	Age
784174	784174	SMITH, 42F N	F	42
813366	813366	JOHNSON, 30F J	F	30
849425	849425	JOHNSON, 22M N	M	22
861215	861215	SMITH, 47M S	M	47
919919	919919	JOHNSON, 20F L	F	20
932438	932438	JOHNSON, 16F L	F	16
947094	947094	SMITH, 40F L	F	40

SP ID: 932438 NAME: JOHNSON, 16F L AGE: 16 Gender: F

Collection	Volume (mL)	Collection Date/Time	Status	Comment Code	Verified
1	400		(none)	(none)	<input type="checkbox"/>

Total Collected:
Total Required: 62

Subtract Tare Value: Would you like to subtract the tare value of 48.
Yes No

Save New Collection OK Cancel

Ready | HUP: idle | MEC Layer: 10/8/2010 | Application: 11.0.0 | Connected to Coordinator | 04:32 PM

Continue to enter the collection date/time, selecting the appropriate urine collection status, and a comment code if applicable. Verify the urine collection by checking the “Verified” box.

If the urine collection is the first or second collection and is QNS, second and third instances of urine collection may be added by using the New Collection button at the bottom of the screen.



Add a second or third collection only if the previous collection was QNS. Enter the second or third urine collection results when the sample is submitted to the MEC laboratory. Do this by typing in the boxes for volume and collection date/time and then selecting the appropriate urine collection status and a comment code if applicable.

Verify the urine collection by checking the Verify box. Click Save to save changes or select the  in the upper right corner to exit out of the Urine Collection screen.

4.6.3 Manually Entering Adults Who Collect in CC2

1. Place the urine on the scale
2. Document the volume
3. Subtract 64 g from the volume
4. Use procedure 4.6.2 to enter the calculated weight into ISIS.

4.7 Urine Specimen Assays

Process urine specimens using the disposable transfer pipettes for the following tests:

- Pregnancy test for selected females aged 8-11 and all females aged 12 to 59 years;
- Albumin/Creatinine (Alb/Creat) on primary SPs aged 3 years and older;
- Chlamydia (Chlam), Trichomonas (Trich) and Mycoplasma genitalium (Mgen) on primary SPs 14-39 years old;
- Trichomonas (Trich) and Mycoplasma genitalium (Mgen) on SPs 40-59 years old;
- Speciated Arsenic (Spc Arsenic) on all SPs aged 3-5 years, selected SPs aged 6 years and older, and all adult smokers (18+);
- Priority Pesticides (Prior Pest) on all SPs aged 3-5 and selected SPs aged 6 years and older;
- Organophosphates (Organophos) on all SPs aged 3-5 and selected SPs aged 6 years and older;
- Urine Mercury/Iodine (Urin Merc) on all SPs aged 3-5 and selected SPs aged 6 years and older;
- Metals on all SPs aged 3-5, selected SPs aged 6 years and older, and all adult smokers (18+);
- Arsenic, Chromium and Nickel on all SPs 3 to 5 years old and selected SPs 6 years and older;
- Polyaeromatic Hydrocarbons (PAH) on all SPs aged 3-5, selected SPs aged 6 years and older, and all adult smokers (18+);
- Phthalates on all SPs aged 3-5 and selected SPs aged 6 years and older;

- Perchlorate/VOCs/Thiocyanate on all SPs aged 3-5, selected SPs aged 6 years and older, and all adult smokers (18+);
- TSNA/NNAL/Nicotine Analogs(a tobacco-specific nitrosamine)/Heterocyclic Amines on all SPs aged 3-5, selected SPs aged 6 years and older, and all adult smokers (18+);
- Aromatic Amines on all SPs aged 3-5, selected SPs aged 6 years and older, and all adult smokers (18+);
- Diisocyanate on all SPs aged 3-5, selected SPs aged 6 years and older; and
- Extra urine (Xtra Urine) on SPs aged 3 years and older.

4.8 Urine Specimen Protocols

Table 4-1 summarizes the urine processing protocol for primary SPs. Process urine in priority order with vessel 45 filled first, 46 second, etc.

Table 4-1. NHANES urine processing protocol – primary

Vessel no.	Assay	Age in years	Sample size ml	Vessel
45	Alb/Creat	3+	3	5-ml cryovial
46	Chlam/Trichomonas/Mgen	14-39	5	5-ml cryovial
154	Trichomonas/Mgen	40-59	5	5-ml cryovial
86	Spc Arsenic	3+	2	2-ml cryovial
48	Prior Pest	3+	5 (3-5) 7 (6+)	10-ml screwcap
49	Organophos	3+	5 (3-5) 7 (6+)	10-ml screwcap
62	Urin Merc/Iodine	3+	5	10-ml w/presv
50	Metals	3+	8	5-ml cryovial
220	Arsenic/Chromium/Nickel	3+	4	5-ml 5-0 cryovial
66	PAH	3+	3	5-ml cryovial
67	Phthalates	3+	4.5	10-ml screwcap
102	Perchlorate/VOC/Thiocyanate	3+	5	5-ml cryovial
156	TNSA/NNAL/NAs/HAs	3+	7	10-ml screwcap
152	Aromatic Amines	3+	5	5-ml cryovial
218	Diisocyanate	3+	5	5-ml cryovial
52	Xtra Urine 1	3+	5	5-ml cryovial
139	Xtra Urine 2	3+	5	5-ml cryovial

4.9 Labeling Urine Processing Vessels

The appropriate barcode labels automatically print for each SP based on the SP's age, sex, appointment type, and subsample selection. The label/ship technologist at workstation 1 prints the labels at least one session in advance. The printing procedure is described in Chapter 8. The label/ship technologist places the urine labels at workstation 3 at the beginning of each session.

Process urine on one SP at a time. Set up each urine processing rack using the preprinted labels. Label each vessel with the appropriate vessel label, according to the protocol. Place the label on the vessel, wrapping it around the vessel horizontally, making sure the label wraps onto itself. Set the vessels in the cube racks in priority order.

If an SP has not checked in, separate the labels for SPs who have checked in from SPs who have not checked in. Set the labels aside for SPs who have not checked in. If the SP does not show up for the session, then discard the labels at the end of the session.

4.10 Urine Specimen Processing

- Perform pregnancy test and record results before aliquoting the urine specimen.
- Label all urine aliquot vessels for the SP and place in priority order in the rack.

Using the large 15-ml plastic transfer pipette for all but vessel 62, aliquot the urine sample for each of these tests using the following procedure: (Pouring directly from the specimen cup into the vessel is allowed.)

Vessel	Action
45	Aliquot 3 ml of urine for Alb/Creat into a 5-ml vessel
46	Aliquot 5 ml of urine for Chlam/Trich/Mgen (14-39 years old) into 5-ml vessel
154	Aliquot 5 ml of urine for Trich/Mgen (40-59 years old) into a 5-ml vessel
86	Aliquot 2 ml of urine for Spc Arsenic into a 2-ml vessel
48	Aliquot 5 ml of urine for 3- to 5-year-olds and 7 ml of urine for 6+ for Prior Pest into a 10-ml vessel

Vessel	Action
49	Aliquot 5 ml of urine for 3- to 5-year-olds and 7 ml of urine for 6+ for Organophos into a 10-ml vessel
62	Urin Merc. <u>Transfer exactly 5-ml of urine, using the 3.5-ml disposable transfer pipette to measure into the 10-ml screwcap vessel containing a preservative</u> , close the cap, and mix gently. If the vessel does become inverted, tap the bottom of the capped vessel against a hard surface before opening. Open cap and pipette 5 ml of urine into the 10-ml vessel. Do not discard the prepared tubes even if the preservative crystallizes. If the preservative crystallizes, add 5 ml of urine with the 3.5-ml <u>disposable transfer pipette</u> and mix extremely well. Do not use these tubes for any other purpose since they contain a preservative. Always store the Urine Mercury tubes in an upright position.
50	Aliquot 4 ml of urine for Metals into a 5-ml vessel
220	Aliquot 4 ml of urine for Arsenic/Chromium/Nickel into a Five-O 5-ml vessel
66	Aliquot 3 ml of urine for PAH into a 5-ml vessel
67	Aliquot 4.5 ml of urine for Phthalates into a 10-ml screwcap vessel
102	Aliquot 5 ml of urine for Perchlorate/Volatile Organic Compounds (VOC)/Thiocyanate into a 5-ml vessel
156	Aliquot 7 ml of urine for TSNA/NNAL/NAs/HAs into a 10-ml vessel
152	Aliquot 5 ml of urine for Aromatic Amines into a 5-ml vessel
218	Aliquot 5 ml of urine for Diisocyanates into a 5-ml vessel
52	Aliquot 5 ml of urine for Xtra Urine 1 into a 5-ml vessel
139	Aliquot 5 ml of urine for Xtra Urine 2 into a 5-ml vessel

If the SP has opted out of Future Studies, the SP won't have vessels 52 or 139 in his or her profile. Inform the blood processing technologist that there are not any extras on that SP.

Discard any remaining urine specimen at the end of each session after container verification is completed. Pour urine down the drain in the laboratory sink that is connected to the sewer. Flush

the sink with water. Discard urine cup in the regular trash, after peeling off the label or marking out the name.

Do not process urine on more than one SP at a time.

4.11 Record the Results of Urine Specimen Processing

After filling the urine specimen vessels for each SP, use the Urine Processing module to enter the results of urine processing.

Access the Urine Processing module.

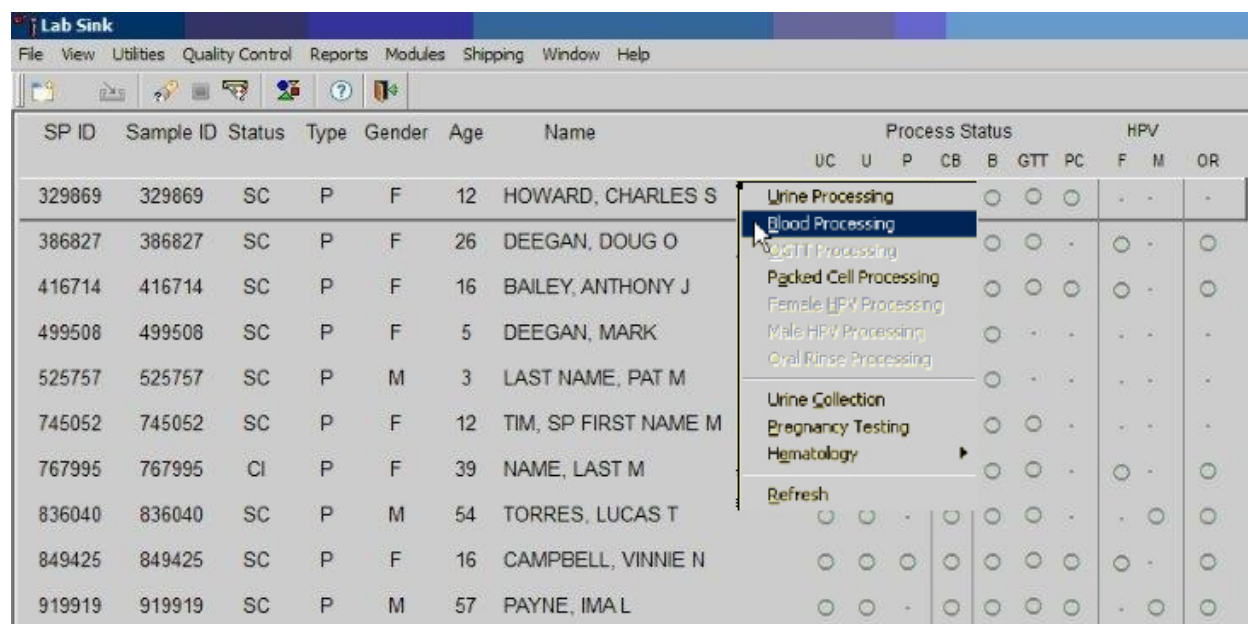

The screenshot shows the 'Lab Sink' software interface. The main window displays a table of urine specimens with columns for SP ID, Sample ID, Status, Type, Gender, Age, Name, Process Status, and HPV. The 'Process Status' column includes sub-columns for UC, U, P, CB, B, GTT, PC, F, M, and OR. The 'HPV' column includes sub-columns for F, M, and OR. A context menu is open over the first specimen (SP ID 329869, Sample ID 329869, Name HOWARD, CHARLES S), showing options such as Urine Processing, Blood Processing, GTT Processing, Packed Cell Processing, Female HPV Processing, Male HPV Processing, Oral Rinse Processing, Urine Collection, Pregnancy Testing, Hematology, and Refresh. The 'Urine Processing' option is highlighted.

SP ID	Sample ID	Status	Type	Gender	Age	Name	Process Status							HPV					
							UC	U	P	CB	B	GTT	PC	F	M	OR			
329869	329869	SC	P	F	12	HOWARD, CHARLES S	<input type="radio"/>	<input type="radio"/>	<input type="radio"/>	<input type="radio"/>	<input type="radio"/>	<input type="radio"/>	<input type="radio"/>	<input type="radio"/>	<input type="radio"/>	<input type="radio"/>	<input type="radio"/>	<input type="radio"/>	<input type="radio"/>
386827	386827	SC	P	F	26	DEEGAN, DOUG O	<input type="radio"/>	<input type="radio"/>	<input type="radio"/>	<input type="radio"/>	<input type="radio"/>	<input type="radio"/>	<input type="radio"/>	<input type="radio"/>	<input type="radio"/>	<input type="radio"/>	<input type="radio"/>	<input type="radio"/>	<input type="radio"/>
416714	416714	SC	P	F	16	BAILEY, ANTHONY J	<input type="radio"/>	<input type="radio"/>	<input type="radio"/>	<input type="radio"/>	<input type="radio"/>	<input type="radio"/>	<input type="radio"/>	<input type="radio"/>	<input type="radio"/>	<input type="radio"/>	<input type="radio"/>	<input type="radio"/>	<input type="radio"/>
499508	499508	SC	P	F	5	DEEGAN, MARK	<input type="radio"/>	<input type="radio"/>	<input type="radio"/>	<input type="radio"/>	<input type="radio"/>	<input type="radio"/>	<input type="radio"/>	<input type="radio"/>	<input type="radio"/>	<input type="radio"/>	<input type="radio"/>	<input type="radio"/>	<input type="radio"/>
525757	525757	SC	P	M	3	LAST NAME, PAT M	<input type="radio"/>	<input type="radio"/>	<input type="radio"/>	<input type="radio"/>	<input type="radio"/>	<input type="radio"/>	<input type="radio"/>	<input type="radio"/>	<input type="radio"/>	<input type="radio"/>	<input type="radio"/>	<input type="radio"/>	<input type="radio"/>
745052	745052	SC	P	F	12	TIM, SP FIRST NAME M	<input type="radio"/>	<input type="radio"/>	<input type="radio"/>	<input type="radio"/>	<input type="radio"/>	<input type="radio"/>	<input type="radio"/>	<input type="radio"/>	<input type="radio"/>	<input type="radio"/>	<input type="radio"/>	<input type="radio"/>	<input type="radio"/>
767995	767995	CI	P	F	39	NAME, LAST M	<input type="radio"/>	<input type="radio"/>	<input type="radio"/>	<input type="radio"/>	<input type="radio"/>	<input type="radio"/>	<input type="radio"/>	<input type="radio"/>	<input type="radio"/>	<input type="radio"/>	<input type="radio"/>	<input type="radio"/>	<input type="radio"/>
836040	836040	SC	P	M	54	TORRES, LUCAS T	<input type="radio"/>	<input type="radio"/>	<input type="radio"/>	<input type="radio"/>	<input type="radio"/>	<input type="radio"/>	<input type="radio"/>	<input type="radio"/>	<input type="radio"/>	<input type="radio"/>	<input type="radio"/>	<input type="radio"/>	<input type="radio"/>
849425	849425	SC	P	F	16	CAMPBELL, VINNIE N	<input type="radio"/>	<input type="radio"/>	<input type="radio"/>	<input type="radio"/>	<input type="radio"/>	<input type="radio"/>	<input type="radio"/>	<input type="radio"/>	<input type="radio"/>	<input type="radio"/>	<input type="radio"/>	<input type="radio"/>	<input type="radio"/>
919919	919919	SC	P	M	57	PAYNE, IMA L	<input type="radio"/>	<input type="radio"/>	<input type="radio"/>	<input type="radio"/>	<input type="radio"/>	<input type="radio"/>	<input type="radio"/>	<input type="radio"/>	<input type="radio"/>	<input type="radio"/>	<input type="radio"/>	<input type="radio"/>	<input type="radio"/>

To access the Urine Processing module, direct the mouse arrow to the correct SP, right-click, drag the mouse arrow to the Urine Processing tab, and right-click. Alternatively, use the up and down keys to move up and down the list until the correct SP is highlighted, right-click, drag the mouse arrow to the Urine Processing tag, and right-click.

The SP's urine processing window displays.

U processing

Tech ID: 1756 Sample ID: 919919 Name: PAYNE, IMA L Gender: F Age: 25
 SP ID: 919919 Appt Type: Primary Fasting Req: Morning - Fast

Vessel ID	Test Name	CAP	Sample Volume	Type	Vessel Volume	Vessel Name	Filled	Comments	Container ID	Slot#
45	Alb/Creat		3.0	U	5 ml	Nalge Cryovial	<input type="radio"/> Yes <input type="radio"/> No			
46	Chlam/Trich/Mgon		10.0	U	5 ml	Nalge Cryovial	<input type="radio"/> Yes <input type="radio"/> No			
86	Spc Arsenic		3.0	U	5 ml	Nalge Cryovial	<input type="radio"/> Yes <input type="radio"/> No			
62	UrineHg/I		5.0	U	10 ml	WWR Screwcap	<input type="radio"/> Yes <input type="radio"/> No			
50	Metals		8.0	U	5 ml	Nalge Cryovial	<input type="radio"/> Yes <input type="radio"/> No			
66	PAH		3.0	U	5 ml	Nalge Cryovial	<input type="radio"/> Yes <input type="radio"/> No			
102	PerVOC/TCY		5.0	U	5 ml	Nalge Cryovial	<input type="radio"/> Yes <input type="radio"/> No			
156	TSNAs		10	U	10 ml	WWR Screwcap	<input type="radio"/> Yes <input type="radio"/> No			
152	Aro amine		5	U	5 ml	Nalge Cryovial	<input type="radio"/> Yes <input type="radio"/> No			
151	Vol NA		5	U	5 ml	Nalge Cryovial	<input type="radio"/> Yes <input type="radio"/> No			
153	HAA/nict		2	U	2 ml	Nalge Cryovial	<input type="radio"/> Yes <input type="radio"/> No			

Save OK Cancel

The urine processing window contains the following information for SPs: Tech ID, Sample ID, SP ID, Name (last, first), Gender, Age, Appt (appointment) Type, and Fasting Req. There are columns that list the Vessel ID, Test Name, Sample Volume, Sample Type (U = urine), Vessel Volume, Vessel Name, Filled (Yes or No) radio buttons, Comment drop-down box, and Container ID and Container Slot# column.

To mark an individual urine vessel as collected or Filled – Yes, direct the mouse arrow to the center of the Yes radio button and left-click. As each vessel is marked as Filled – Yes, it is automatically assigned to a slot in an existing (open) container and the next open slot number.

To mark an individual urine vessel as not collected or Filled – No, direct the mouse arrow to the center of the No radio button and left-click. As each vessel is marked as Filled – No, the comment “quantity not sufficient” is automatically entered in the Comments column.

To collectively mark all vessels as Filled – “Fill All”; “Yes” will be auto-filled on all.

The screenshot shows the 'Lab Subsystem' application window. At the top, there is a menu bar with 'File', 'View', 'Utilities', 'Quality Control', 'Reports', 'Modules', 'Shipping', 'Window', and 'Help'. Below the menu bar is a toolbar with various icons. The main window title is 'UR: 919919' and the subtitle is 'U processing'.

Below the title bar, there is a patient information section with the following details:

- Tech ID: 1756
- Sample ID: 919919
- Name: PAYNE, IMA L
- Gender: F
- Age: 25
- SP ID: 919919
- Appt Type: Primary
- Fasting Req: Morning - Fast

Below the patient information is a table with the following columns: Vessel ID, Test Name, CAP, Sample Volume, Type, Vessel Volume, Vessel Name, Filled (radio buttons), Comments, Container ID, and Slot#. A context menu is open over the 'Fill All' button of the first row (Vessel ID 45).

Vessel ID	Test Name	CAP	Sample Volume	Type	Vessel Volume	Vessel Name	Filled	Comments	Container ID	Slot#
45	Alb/Creat	3.0	U	5 ml	Nalge Cryovial	<input checked="" type="radio"/> Yes <input type="radio"/> No	Fill All	(none)	0615340	6
46	Chlam/Trich	10.0	U	14 ml	17 x 100 Falcon	<input checked="" type="radio"/> Yes <input type="radio"/> No	Not Filled All	(none)	0615341	2
86	Spc Arsenic	3.0	U	5 ml	Nalge Cryovial	<input checked="" type="radio"/> Yes <input type="radio"/> No		(none)	0615347	2
62	UrineHg/I	5.0	U	10 ml	WWR Screwcap	<input checked="" type="radio"/> Yes <input type="radio"/> No		(none)	0615344	1
50	Heavy Metal	8.0	U	14 ml	Falcon	<input type="radio"/> Yes <input checked="" type="radio"/> No		quantity not suffic		
66	PAH	3.0	U	5 ml	Nalge Cryovial	<input type="radio"/> Yes <input type="radio"/> No				
102	PerVOC/TCY	5.0	U	5 ml	Nalge Cryovial	<input type="radio"/> Yes <input type="radio"/> No				
156	TSNAs	10	U	10 ml	WWR Screwcap	<input type="radio"/> Yes <input type="radio"/> No				
152	Aro amine	5	U	5 ml	Nalge Cryovial	<input type="radio"/> Yes <input type="radio"/> No				
151	Vol NA	5	U	5 ml	Nalge Cryovial	<input type="radio"/> Yes <input type="radio"/> No				
153	HAA/nict	2	U	2 ml	Nalge Cryovial	<input type="radio"/> Yes <input type="radio"/> No				

At the bottom of the window, there are three buttons: 'Save', 'OK', and 'Cancel'.

To collectively mark all vessels as Filled – Yes, direct the mouse arrow to the Filled button on the top of the radio buttons, left-click, and drag the arrow to Fill All and left-click.

To collectively mark all vessels as Filled – No.

Vessel ID	Test Name	CAP	Sample Volume	Type	Vessel Volume	Vessel Name	Filled	Comments	Container ID	Slot#
45	Alb/Creat		3.0	U	5 ml	Nalge Cryovial	<input checked="" type="radio"/> Yes <input type="radio"/> No		0615340	6
46	Chlam/Trich		10.0	U	14 ml	17 x 100 Falcon	<input checked="" type="radio"/> Yes <input type="radio"/> No	(none)	0615341	2
86	Spc Arsenic		3.0	U	5 ml	Nalge Cryovial	<input checked="" type="radio"/> Yes <input type="radio"/> No	(none)	0615347	2
62	UrineHg/I		5.0	U	10 ml	WWR Screwcap	<input checked="" type="radio"/> Yes <input type="radio"/> No	(none)	0615344	1
50	Heavy Metal		8.0	U	14 ml	Falcon	<input type="radio"/> Yes <input checked="" type="radio"/> No	quantity not suffic		
66	PAH		3.0	U	5 ml	Nalge Cryovial	<input type="radio"/> Yes <input checked="" type="radio"/> No			
102	Per/VOC/TCY		5.0	U	5 ml	Nalge Cryovial	<input type="radio"/> Yes <input checked="" type="radio"/> No			
156	TSNAs		10	U	10 ml	WWR Screwcap	<input type="radio"/> Yes <input checked="" type="radio"/> No			
152	Aro amine		5	U	5 ml	Nalge Cryovial	<input type="radio"/> Yes <input checked="" type="radio"/> No			
151	Vol NA		5	U	5 ml	Nalge Cryovial	<input type="radio"/> Yes <input checked="" type="radio"/> No			
153	HAA/nict		2	U	2 ml	Nalge Cryovial	<input type="radio"/> Yes <input checked="" type="radio"/> No			

To mark all vessels as Filled – No, direct the mouse arrow to the Filled box, left-click, drag the mouse arrow to Not Filled All, and left-click.

Exhibit 4-4. Quality comment codes to use for filled vessels

Comment Code	Use when:
Blood present	Blood is visible in the specimen.
Contamination, foreign matter	Use if the sample appears to contain any foreign matter.
Contamination, SP touched inside of container	Use if it was reported the SP or parent/guardian touched the inside of the container during collection.
Possible contamination	Use if the sample appears to be contaminated.
Room temp >30°C	Use if sample was processed when room temperature was >30 °C.

To enter the quality control comment “blood present,” “contamination – foreign matter,” “contamination – SP touched inside of container,” “possible contamination,” or “room temp >30°C” for a filled vessel, direct the mouse arrow to the drop-down list in the Comments column, left-click to display the choices, drag the mouse arrow to the Blood present tab, and left-click.

If a vessel is marked as Filled – No, the comment “quantity not sufficient” is automatically entered. Review the comment for all insufficient urine collections and correct the comment, when necessary.

Exhibit 4-5. Comment codes

Comment Code	Use when:
Awaiting SP sample	At the end of the session and SP hasn't provided another urine sample.
Contamination, foreign matter	If urine sample is contaminated with any materials, such as toilet paper or stool.
Contamination, urine container fell in toilet	If the urine container fell in the toilet during or after collection.
Laboratory error	A technologist makes an inadvertent error when processing.
Quantity not sufficient	The amount of urine received in the lab is insufficient to fill this vessel.

Continue recording and updating urine collection results as specimens are delivered to the laboratory. Review the information in the urine-processing window and save the data to the database.

Store each filled vessel in the assigned slot in the assigned container. To record this action or to save the data to the database, direct the mouse arrow to the “Save” button and left-click. To record this action or to save the data to the database and exit the module, direct the mouse arrow to the “OK” button and left-click. To close the window without saving any data in the database, direct the mouse arrow to the “Cancel” button and left-click.

4.12 Second and Third Urine Samples

If the initial urine sample does not meet the minimum volume requirement, hold the initial urine at room temperature until enough additional urine is received in the second or third urine collection to meet the minimum requirements to complete the protocol or the session ends for 6+ SPs and second urine collection for SPs 3-5 yrs. If a subsequent sample collection fulfills the protocol requirement, pool the initial and subsequent urine samples into the most recently collected specimen urine cup, update the Urine Collection module, access the Urine Processing module, fill the vessels, and record the results. If the session ends and no additional urine has been collected, access the

Urine Processing module, fill as many vessels as possible in priority order, mark the remaining vessels as Filled – No, with the Comment Code “Quantity not sufficient,” and save the results.

4.13 Specimen Storage

Fill the urine vessels, enter the urine processing results, and prepare to store the vessels. Store vessels in numbered storage boxes according to test as indicated in Table 4-2. Check the slot assignment of each urine processing container at the end of each processing session by accessing the content container verification. Verify the contents of each container against the system. Mark the top of the last vessel, verified by container verification for each session with a mark specific to each individual tech.

At the beginning of each stand, generate and print a series of bar-coded, numbered labels for storage containers as described in Chapter 8. Use the shipping module to assign a barcode label to a specific storage container (test). This process “opens” a storage box. Each vessel is assigned to a specific slot in a specific container as processing results are entered. Slots in containers are assigned according to a standard left-to-right, top-to-bottom procedure. Store each vessel in the appropriate slot in the correct container immediately after processing.

Table 4-2. Storage and shipping protocol for urine

Lab #	Shipping location	Vessels	Conditions	Frequency	Vessel storage	
16	University of Minnesota	45	Alb/Creat	Frozen	Weekly	9x9 three-inch box
5	CDC/NCID NCHSTD	46	Chlam/Trich/Mgen	Frozen	Weekly	9x9 three-inch box
5	CDC/NCID NCHSTD	154	Trich/Mgen	Frozen	Weekly	9x9 three-inch box
6	CASPIR	86	Spc Arsenic	Frozen	Weekly	9x9 two-inch box
6	CASPIR	48	Prior Pest	Frozen	End of stand or when full	5x5 three-inch box
6	CASPIR	49	Organophos	Frozen	End of stand or when full	5x5 three-inch box
6	CASPIR	62	Urin Merc	Frozen	Weekly	5x5 three-inch box
6	CASPIR	50	Metals	Frozen	Weekly	5x5 three-inch box
6	CASPIR	220	Arsenic/Chromium/Nickel	Frozen	Weekly	5x5 three-inch box with foam insert
6	CASPIR	66	PAH	Frozen	End of stand or when full	9x9 three-inch box
6	CASPIR	67	Phthalates	Frozen	End of stand or when full	9x9 three-inch box
6	CASPIR	102	Perchlorate/VOC/Thiocyanate	Frozen	End of stand or when full	9x9 three-inch box
6	CASPIR	156	TSNA (plus)	Frozen	Weekly	5x5 three-inch box
6	CASPIR	152	Aromatic Amines	Frozen	Weekly	9x9 three-inch box
6	CASPIR	218	Diisocyanates	Frozen	End of stand or when full	9x9 three-inch box
6	CASPIR	52	Xtra Urine 1	Frozen	End of stand or when full	9x9 three-inch box
6	CASPIR	139	Xtra Urine 2	Frozen	End of stand or when full	9x9 three-inch box

4.14 How to Deal With System Failure

If the computer system fails, record results on a preprinted workstation 3 processing worksheet (Exhibit 4-6). Complete a workstation 3 worksheet for each SP after performing the pregnancy test, and while processing the urine specimens. Enter the results after the system is operational. Send the worksheets to the home office at the end of the stand.

Exhibit 4-6. Workstation 3 processing worksheet

URINE COLLECTION, PREGNANCY TEST, URINE PROCESSING

SP ID _____

	Urine Collected Age 3+	Yes ✓	Yes/QNS ✓	No ✓	Comments: Communication problem No time Quantity not sufficient SP <u>ill</u> /emergency SP <u>refusal</u> SP <u>unable</u> to comply	Weight of Urine Collection
Result						UC1: UC2: UC3:
	Pregnancy Test Age 8-17	Negative ✓	Invalid ✓	Positive ✓	Serum Confirmation Result (Send observation to physician)	
Result						
	Pregnancy Test Age 18-59	Negative ✓	Invalid ✓	Positive ✓		
Result						

Exhibit 4-6. Workstation 3 processing worksheet (continued)

ID	Name	Ages	Sample ml	Sample Type	Tube Size	Filled ✓	Comments:	
							QNS Blood Present	Slot #
45	Alb/Creat	3+	3	Urine	5-ml cryovial			
46	Chlam/Trich/ Mgen	14-39	5	Urine	5-ml cryovial			
154	Trich/ Mgen	40-59	5	Urine	5-ml cryovial			
86	Spc Arsenic	3+	2	Urine	2-ml cryovial			
48	Prior Pest	3+	5 (3-5), 7 (6+)	Urine	10-ml Screwcap			
49	Organophos	3+	5 (3-5), 7 (6+)	Urine	10-ml Screwcap			
62	Urn Merc/Iodine	3+	5	Urine	10-ml Screwcap w/presv			
50	Metals	3+	4	Urine	5-ml cryovial			
220	Arsenic/ Chromium/ Nickel	3+	4	Urine	Five-0 5-ml Cryovial			
66	PAH	3+	3	Urine	5-ml cryovial			
67	Phthalates	3+	4.5	Urine	10-ml Screwcap			
102	Perchlorate/ VOC/ Thiocyanate	3+	5	Urine	5-ml cryovial			
156	TSNA/NNAL/ Thiocyanate/ Heterocyclic Amines	3+	7	Urine	10-ml Screwcap			
152	Aromatic Amines	3+	5	Urine	5-ml cryovial			
218	Diisocyanates	3+	5	Urine	5-ml cryovial			
52	Xtra Urine 1	3+	5	Urine	5-ml cryovial			
139	Xtra Urine 2	3+	5	Urine	5-ml cryovial			

5.1 Purpose and Principle of the Test

Perform a pregnancy test on females of all appointment types who are aged 12–59 years, and girls 8-11 who report that they are menstruating when asked during the home interview. A positive test result excludes pregnant women aged 8–59 from participating in the dual-energy x-ray absorptiometry (DXA) and Liver Ultrasound Transient Elastography (LUTE), components of the MEC exam. Report test results immediately since these components are not assigned until the results of the pregnancy test are documented. If a urine pregnancy test is positive on any female study participant (SP) aged 8-17 years, a supplemental qualitative serum pregnancy test is performed. If no blood is drawn, the urine test is repeated. Notify the physician of positive or negative results obtained from the supplemental serum testing, repeat urine test, or the inability to perform a follow-up test using the observation function.

Laboratory tests for pregnancy are based on detecting elevated levels of human chorionic gonadotropin (hCG), a hormone that the placenta begins to produce in increasing amounts shortly after fertilization. The ICON® 25 hCG (Urine/Serum) test kit is a rapid chromatographic immunoassay for the qualitative detection of human chorionic gonadotropin (hCG) in urine or serum to aid in the early detection of pregnancy.

In normal pregnancy, hCG can be detected in both urine and serum as early as 7 to 10 days after conception. The hCG levels continue to rise very rapidly, frequently exceeding 100 mIU/ml (milli-international units per milliliter) by the first missed menstrual period, and peaking in the 100,000 to 200,000 mIU/ml range about 10-12 weeks into pregnancy. The appearance of hCG in both urine and serum soon after conception, and its subsequent rapid raise in concentration during early gestational growth, make an excellent marker for the detection of pregnancy.

The ICON® 25 hCG test is a rapid test that qualitatively detects the presence of hCG in urine or serum sample at the sensitivity of 25 mIU/ml. The test utilizes a combination of monoclonal and polyclonal antibodies to selectively detect elevated levels of hCG in urine or serum. At the level of claimed sensitivity, the ICON® 25 hCG test shows no cross-reactivity interference from the structurally related glycoprotein hormones hFSH, hLH, and hTSH at high physiological levels.

The assay is conducted by adding urine or serum sample to the sample well of the test device. The sample migrates via capillary action along the membrane to react with colored conjugate. Positive samples react with the specific antibody-hCG-colored conjugate to form a colored line at the test region of the membrane. Absence of this colored line suggests a negative result. To serve as a procedural control, a colored line will always appear at the control line region if the test has been performed properly.

5.2 Special Safety Precautions

ICON® 25 hCG Test (Urine or Serum)

- This test is for professional *in vitro* diagnostic use only.
- Do not use the kit beyond the expiration date.
- The test device should remain in the sealed pouch until use.
- Observe standard guidelines for handling biological hazards.
- Wear gloves while handling specimens. After use, dispose of gloves and other contaminated materials appropriately in a proper biohazard container and wash hands.

Sure-Vue™ hCG Urine and Serum Control Sets

- Sure-Vue™ hCG urine and serum controls are intended to be used to monitor the performance and accuracy of pregnancy test kits. These controls are for professional use only.
- The use of known controls in the laboratory is invaluable. It is important to verify testing procedures to confirm the validity of the results reported. Testing Sure-Vue™ hCG Urine and Serum Controls will provide assurance that the pregnancy test kit is performing properly.
- Reagents in these kits contain 0.2 percent of sodium azide, which may react with lead or copper plumbing to form potentially explosive metal azides. When disposing of such reagents, always flush with large volumes of water to prevent azide buildup. This reagent is harmful if swallowed. Contact with acids liberates very toxic gas. After contact with skin, wash immediately with plenty of water.
- Do not use the controls beyond the expiration date.

5.3 Computerization: Integrated Survey Information System (ISIS)

The MEC-automated ISIS system captures all data and stores it electronically at Westat's home office in Rockville, Maryland. Access the Pregnancy QC module to enter the quality control results. The session number, technologist ID, and run number are automatically captured; enter the kit lot number and expiration date, and the urine and serum control lot and expiration dates. Record control results and save them to the database. All pregnancy quality control results are immediately available electronically at the home office. All data are backed up and stored at Westat's home office.

5.4 Specimen Collection and Preparation

Collect a urine specimen on all SPs 3 years and older into a clean and dry plastic container and document the collection in the urine collection module as described in Chapter 4. Perform a urine pregnancy test on females of all person types who are aged 12-59 years and girls aged 8-11 who report that they are menstruating when asked during the home interview. If a urine pregnancy test is positive on any female SP aged 8-17, perform the hCG test using serum. If no blood is drawn, repeat the urine test. Notify the physician of the positive or negative follow-up test, or the inability to perform a follow-up test using the observation function. Assay all specimens immediately and record results in the Laboratory Pregnancy Testing module.

Specimen Collection and Preparation for SPs Returning for Rescheduled for DXA or LUTE

Collect a urine specimen on all female SPs 8 to 59 years old who return to the MEC for a rescheduled DXA and LUTE, as a second negative result must be obtained on the day these components are completed. Follow routine procedures to perform a urine pregnancy test and provide the results to the Coordinator through a message; negative results will allow DXA and LUTE to be performed while a positive result will make the SP ineligible. There is already a record of a negative result in the database, which should not be overwritten with any results from the follow-up visit.

5.5 Procedure for Microscopic Examination

Not applicable.

5.6 Reagents and Supplies

5.6.1 Reagents

- ICON® 25 hCG Urine/Serum test kit
- Product Number 43025 (25)
- Beckman Coulter,
4300 N. Harbor Blvd
Fullerton, CA 92834-3100
<http://www.beckmancoulter.com/pcd>
- Components
 - One test device. (25) – Contains anti-hCG particles and anti-hCG coating on the membrane
 - Disposable sample droppers – Plastic pipettes for measuring and dispensing patient samples (packaged together with the test device in a white foil pouch)
 - Zip closable bag with two extra sample droppers
 - Product instructions
- Storage and Stability
 - Store the ICON® 25 hCG test kit at 2-30°C (35-83°F). The test device is stable up to the expiration date printed on the sealed pouch. Keep the test device in the sealed pouch until use. DO NOT FREEZE. Do not use beyond expiration date. Date and initial the kit when putting it into use.
- Sure-Vue™ hCG Control Sets – Urine and Serum
 - Sure-Vue™ hCG Control Sets – Urine
 - Product Number SA087413-F
 - Fisher Scientific Company

- Components - Sure-Vue™ hCG Control Set
 - Urine is a stable human urine-based material for use as a quality control material. Use controls in the same manner as SP specimens in accordance with the protocol provided in the Sure-Vue™ hCG Control Sets directional insert.
 - Low Positive Control: Human urine containing approximately 25 mIU hCG/ml and 0.2% sodium azide as a preservative. (1 x 5 ml)
 - High Positive Control: Human urine containing approximately 250 mIU hCG/ml and 0.2% sodium azide as a preservative. (1 x 5 ml)
 - Negative Control: Contains 0.2% sodium azide as a preservative. (1 x 5 ml)
 - Storage and Stability - Sure-Vue™ hCG Control Set
 - Store the urine control set between 2 to 8°C (35 to 46°F) at which temperatures these controls are stable until the expiration date printed on the label.
- Sure-Vue™ hCG Serum Control Set
Product Number 087712-F
Fisher Scientific Company
- Components - Sure-Vue™ hCG Serum Control
 - The Sure-Vue™ hCG Serum Control is a stable human serum-based material for use as a quality control material. Use controls in the same manner as SP specimens in accordance with the protocol provided in the Sure-Vue™ hCG Control Set directional insert.
 - Low Positive Control: Human serum containing approximately 25 mIU hCG/ml and 0.2% sodium azide as a preservative. (1 x 5 ml)
 - High Positive Control: Human serum containing approximately 250 mIU hCG/ml and 0.2% sodium azide as a preservative. (1 x 5 ml)
 - Negative Control: Contains 0.2% sodium azide as a preservative. (1 x 5 ml)
 - Storage and Stability - Sure-Vue™ hCG Serum Control
 - Store the Sure-Vue™ hCG Serum Control Set between 2 to 8°C (35 to 46°F) at which temperatures these controls are stable until the expiration date printed on the label.

5.6.2 Supplies

- Timer

5.7 Calibration

Not applicable.

5.8 Assay Procedure

ICON® 25 hCG Test Kit

- Label each test device with the SP ID on a clear section of the test device using a felt tip pen. Label test devices used for quality control as “-” or “+”.
- Use a new transfer dropper for each specimen.

Sure-Vue™ hCG Urine and Serum Control Sets

- The Sure-Vue™ urine and serum controls have droppers built into the tip. The use of the control droppers to add three drops of sample has been validated; do not use the ICON® 25 hCG plastic pipette to add controls.
- Allow controls to reach room temperature before testing. The controls are ready to use. No dilution is required.
- The controls are used in place of the specimen and should be tested according to the ICON® 25 hCG test procedure.
- Discard the high positive urine and serum vials (250 mIU/ml).

Urine or Serum Testing Procedure

Perform the test procedure for ICON® 25 hCG Urine/Serum test at room temperature (15-30°C, 59-86°F). Before proceeding, carefully read Section XII titled “Limitations of Method: Specimen Rejection, Interfering Substances, and Conditions.”

- Remove the test device from the sealed pouch and use it as soon as possible.
- Place the test device on a clean and level surface. Hold the dropper vertically and transfer three full drops of urine or serum (approximately 100 µL) to the sample well (S)

of the test device, and then start the timer. Avoid trapping air bubbles in the sample well.

- Wait for the red line(s) to appear. Read the results at 3 minutes when testing a urine sample or 5 minutes when testing a serum sample. It is important that the background is clear before the result is read.

NOTE: A low hCG concentration might result in a weak line appearing in the test region (I) after an extended period; therefore, do not interpret the result after 3 minutes when testing a urine sample or after 5 minutes when testing a serum sample.

5.9 Reportable Range of Results

Report test results as Positive, Negative, or Invalid.

5.10 Quality Control (QC)

Run negative and low positive urine controls containing hCG at concentrations of 0 and 25 mIU/mL, respectively, just prior to or concurrently with the first examinee pregnancy test each exam day, and when putting a new lot into use. Run negative and low positive serum controls with each serum pregnancy test. The pregnancy QC module contains the following information:

- The session ID number links to the stand number, stand location, date, including day, month, and year. The technologist ID is automatically captured.
- Kit lot number and expiration date fill in automatically from the prior QC report. Update or manually enter this information if necessary.
- The control lot number and expiration date for both the urine and serum control fills in automatically from the prior QC report. Update or manually enter this information if necessary.
- The Control QC Type is either urine or serum. The default type is set as urine.
- Negative Control result.
- Positive Control result.
- Upon a lot change during a stand, test the new lot with low positive and negative controls and update the lot numbers in the Quality Control module.

CAP Proficiency Testing

For purposes of this document, proficiency testing is one method of external quality control in which the analytical performance of a method is evaluated using specimens provided on a periodic basis (usually every 3 months).

Participation in the College of American Pathologist (CAP) proficiency-testing program is part of the comprehensive quality control program. CAP compares the submitted results to established values and issues a report.

CAP sends samples three times a year for qualitative serum hCG and urine hCG. Each serum survey includes five lyophilized sera specimens and each urine survey includes five liquid specimens. Handle and analyze these samples in a manner identical to SP samples. Record results on the correct CAP form, located on the CAP web site, and submit results by the due date indicated on the survey. Send a copy of the CAP result form to the home office at the end of the stand.

Open the Pregnancy QC module.

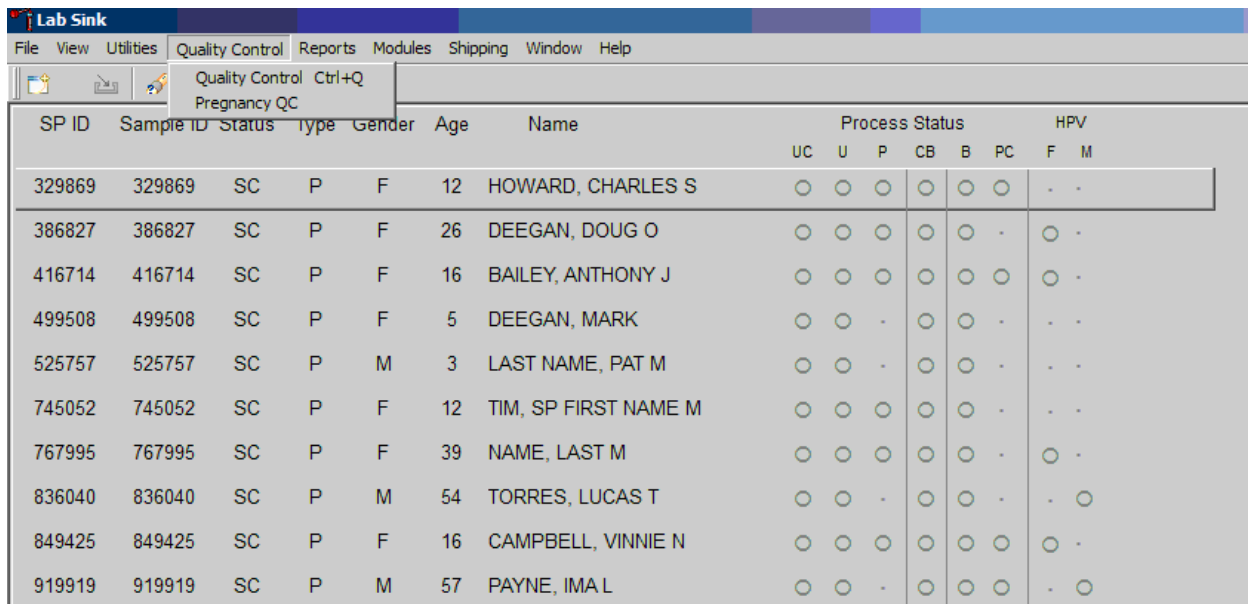

SP ID	Sample ID	Status	Type	Gender	Age	Name	Process Status							
							UC	U	P	CB	B	PC	F	M
329869	329869	SC	P	F	12	HOWARD, CHARLES S	<input type="radio"/>	<input type="radio"/>	<input type="radio"/>	<input type="radio"/>	<input type="radio"/>	<input type="radio"/>	<input type="radio"/>	<input type="radio"/>
386827	386827	SC	P	F	26	DEEGAN, DOUG O	<input type="radio"/>	<input type="radio"/>	<input type="radio"/>	<input type="radio"/>	<input type="radio"/>	<input type="radio"/>	<input type="radio"/>	<input type="radio"/>
416714	416714	SC	P	F	16	BAILEY, ANTHONY J	<input type="radio"/>	<input type="radio"/>	<input type="radio"/>	<input type="radio"/>	<input type="radio"/>	<input type="radio"/>	<input type="radio"/>	<input type="radio"/>
499508	499508	SC	P	F	5	DEEGAN, MARK	<input type="radio"/>	<input type="radio"/>	<input type="radio"/>	<input type="radio"/>	<input type="radio"/>	<input type="radio"/>	<input type="radio"/>	<input type="radio"/>
525757	525757	SC	P	M	3	LAST NAME, PAT M	<input type="radio"/>	<input type="radio"/>	<input type="radio"/>	<input type="radio"/>	<input type="radio"/>	<input type="radio"/>	<input type="radio"/>	<input type="radio"/>
745052	745052	SC	P	F	12	TIM, SP FIRST NAME M	<input type="radio"/>	<input type="radio"/>	<input type="radio"/>	<input type="radio"/>	<input type="radio"/>	<input type="radio"/>	<input type="radio"/>	<input type="radio"/>
767995	767995	SC	P	F	39	NAME, LAST M	<input type="radio"/>	<input type="radio"/>	<input type="radio"/>	<input type="radio"/>	<input type="radio"/>	<input type="radio"/>	<input type="radio"/>	<input type="radio"/>
836040	836040	SC	P	M	54	TORRES, LUCAS T	<input type="radio"/>	<input type="radio"/>	<input type="radio"/>	<input type="radio"/>	<input type="radio"/>	<input type="radio"/>	<input type="radio"/>	<input type="radio"/>
849425	849425	SC	P	F	16	CAMPBELL, VINNIE N	<input type="radio"/>	<input type="radio"/>	<input type="radio"/>	<input type="radio"/>	<input type="radio"/>	<input type="radio"/>	<input type="radio"/>	<input type="radio"/>
919919	919919	SC	P	M	57	PAYNE, IMA L	<input type="radio"/>	<input type="radio"/>	<input type="radio"/>	<input type="radio"/>	<input type="radio"/>	<input type="radio"/>	<input type="radio"/>	<input type="radio"/>

To open the pregnancy QC module, direct the mouse arrow to Utilities in the top menu bar, drag the arrow to Pregnancy QC, and left-click.

Alternatively, open the Pregnancy QC module from the heads-up screen.

The screenshot shows the Lab Sink software interface. The main window displays a table of samples with columns for SP ID, Sample ID, Status, Type, Gender, Age, Name, Process Status, and HPV. A context menu is open over the sample with SP ID 525757, showing options like Urine Processing, Blood Processing, and Pregnancy Testing.

SP ID	Sample ID	Status	Type	Gender	Age	Name	Process Status						HPV	
							UC	U	P	CB	B	PC	F	M
329869	329869	SC	P	F	12	HOWARD, CHARLES S	●	●	○	○	○	○	-	-
386827	386827	SC	P	F	26	DEEGAN, DOU	○	○	○	○	○	○	○	-
416714	416714	SC	P	F	16	JAILEY, ANTHC	○	○	○	○	○	○	○	-
499508	499508	SC	P	F	5	DEEGAN, MAR	○	○	-	○	○	-	-	-
525757	525757	SC	P	M	3	LAST NAME, P	○	○	-	○	○	-	-	-
745052	745052	SC	P	F	12	TIM, SP FIRST	○	○	○	○	○	-	-	-
767995	767995	SC	P	F	39	NAME, LAST M	○	○	○	○	○	-	○	-
836040	836040	SC	P	M	54	TORRES, LUCAS T	○	○	-	○	○	-	-	○
849425	849425	SC	P	F	16	CAMPBELL, VINNIE N	○	○	○	○	○	○	○	-
919919	919919	SC	P	M	57	PAYNE, IMA L	○	○	-	○	○	○	-	○

To access the Pregnancy QC module from the heads-up screen, use the up and down keys to move up and down the list until the correct SP is highlighted, or direct the mouse arrow to the correct SP, right-click, drag the mouse arrow to Pregnancy Testing, and left-click.

The pregnancy QC window displays.

The screenshot shows the Pregnancy QC window. The title bar reads 'PQ: 410111'. The window contains a table with columns for Session, tech.ID, Run #, Kit Lot #, Kit Expiration, Ctrl. Lot #, Ctrl. Expiration, QC Type, Results, and Comments. Below the table are fields for 'pos.' and 'neg.' results, and buttons for 'Add', 'Delete', 'OK', and 'Cancel'.

Session	tech.ID	Run #	Kit Lot #	Kit Expiration	Ctrl. Lot #	Ctrl. Expiration	QC Type	Results	Comments
29-Aug-2004	1126	2	7119001	10-Dec-2008	8563091	10-Jan-2009	urine	pos.: Not Dor neg.: Not Dor	(none)

The pregnancy QC module automatically captures the session date and technologist ID and assigns the run number. **The module defaults to the last kit lot number, kit expiration date, Ctrl (control) lot number, Ctrl expiration date, and the QC type - urine.** Verify the existing kit lot number and expiration date. If the lot number is incorrect, type in the new kit lot number using the keyboard's numeric keys and press Tab to progress to the Kit Expiration blank. Use the calendar to correct the Kit Expiration date. If the screen defaults to the current Ctrl lot number, verify the existing lot number and expiration date. If the lot number is incorrect, type in the new control lot number using the keyboard numeric keys and press Tab to progress to the Ctrl Expiration blank. Use the calendar to correct either the Kit or the Ctrl Expiration date.

Update the Kit or Ctrl Expiration date using the calendar function.

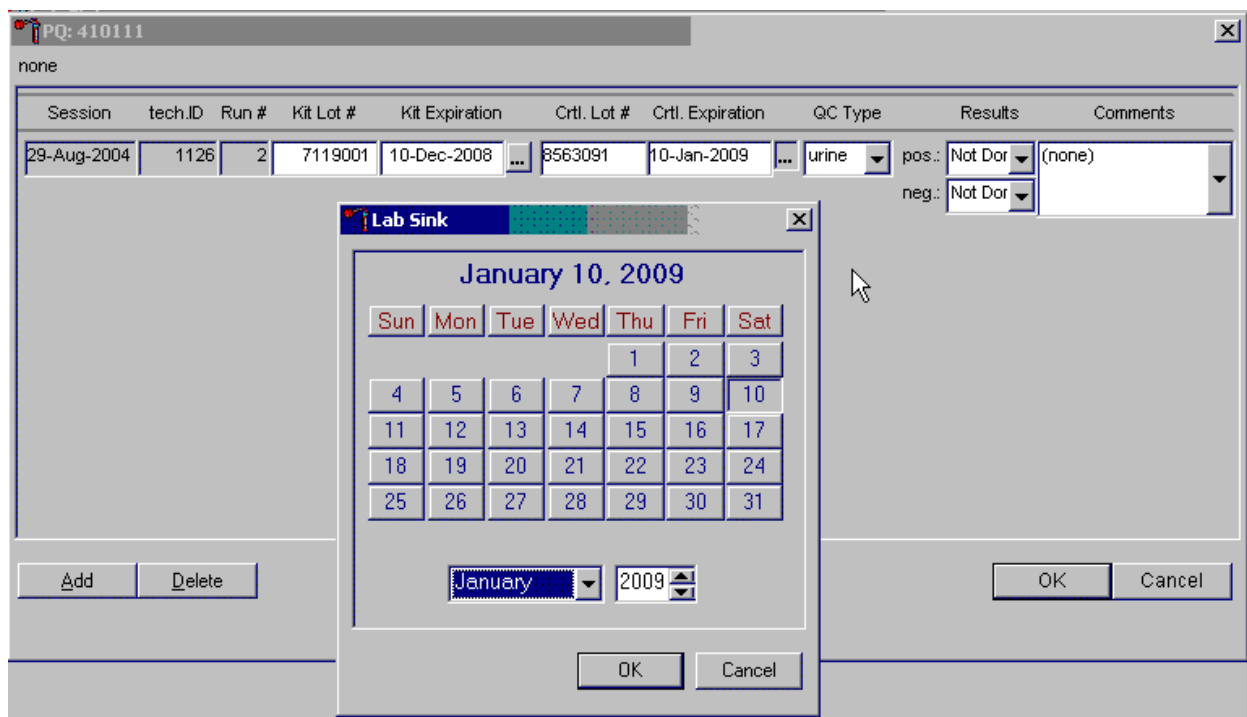

Type in the date using the keyboard's numeric keys and the dd/mm/yyyy format and press Tab or use the calendar to enter the date. To access the calendar, direct the mouse arrow to the ellipsis and left-click. To select the correct month, direct the mouse arrow to the drop-down list, drag the arrow to the correct month (use the scroll bar if necessary) and left-click. To select the correct day, direct the mouse arrow to the correct day on the displayed month and left-click. To correct the year, direct the mouse arrow to up/down controls on the spin box and toggle the year up and down. To transfer this date into the text box, direct the mouse arrow to the OK button and left-click; to exit the calendar function, direct the mouse arrow to the Cancel button, and left-click.

Select the control QC type.

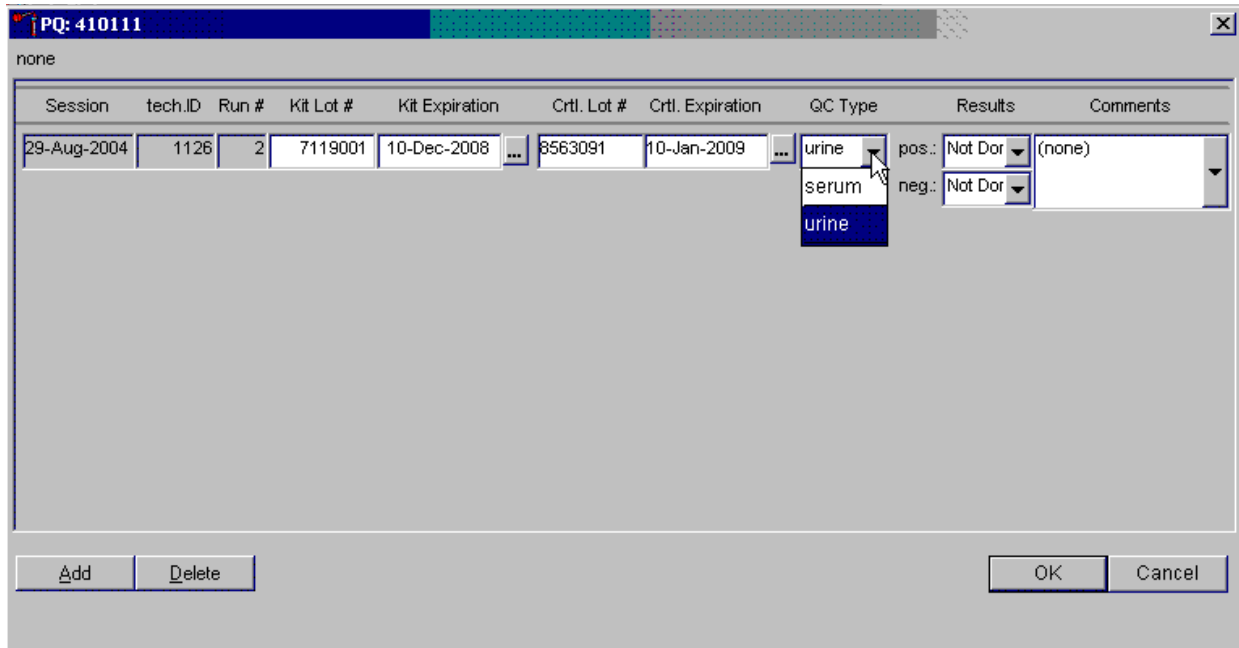

The QC control type default is “Urine.” To change the QC type to serum or to select urine, direct the mouse arrow to the drop-down list, drag the mouse arrow to either serum or urine, and left-click. Alternatively, highlight the QC type text box and type [S/s] for serum or [U/u] for urine and press Tab to move to the result test boxes.

Record the positive and negative control results.

Session	tech.ID	Run #	Kit Lot #	Kit Expiration	Ctrl. Lot #	Ctrl. Expiration	QC Type	Results	Comments
29-Aug-2004	1126	2	7119001	10-Dec-2008	8563091	10-Jan-2009	urine	pos.: Not Done neg.: Not Done	(none)

To enter a result in the positive result text box, type [P/p] for Positive, [N/n] for Negative, or [I/i] for Invalid or use the up and down arrow keys to toggle among the three choices: Positive, Negative, and Invalid and press Tab. Alternatively, direct the mouse arrow to the drop-down list, drag the mouse arrow to Positive, Negative, or Invalid and left-click. If “Positive” is entered, the Negative response box is highlighted. Press Tab to move to the negative result text box.

Enter a result in the negative result text box.

Session	tech.ID	Run #	Kit Lot #	Kit Expiration	Ctrl. Lot #	Ctrl. Expiration	QC Type	Results	Comments
29-Aug-2004	1126	2	7119001	10-Dec-2008	8563091	10-Jan-2009	urine	pos.: Positive neg.: Not Done	(none)

To enter a result in the negative result text box, type [P/p] for Positive, [N/n] for Negative, or [I/i] for Invalid or use the up and down arrow keys to toggle among the three choices: Positive, Negative, and Invalid and press Tab. Alternatively, direct the mouse arrow to the drop-down list, drag the mouse arrow to Positive, Negative, or Invalid, and left-click.

Save results when positive and negative controls demonstrate the expected result.

Session	tech.ID	Run #	Kit Lot #	Kit Expiration	Ctrl. Lot #	Ctrl. Expiration	QC Type	Results	Comments
29-Aug-2004	1126	2	7119001	10-Dec-2008	8563091	10-Jan-2009	urine	pos.: Positive neg.: Negative	(none)

If the positive and negative controls demonstrate the expected result, direct the mouse arrow to the OK button and left-click to save these results and to proceed with pregnancy testing. To cancel and exit the module without recording or saving any QC results to the database, direct the mouse arrow to the Cancel button and left-click. To delete the information in the window and exit the module without recording or saving any QC results to the database, direct the mouse arrow to the Delete button and left-click.

Enter a comment for any result that is inconsistent with expected results. If the OK button is selected before a comment is entered, the ERROR informational message box displays. Review the text in this box.

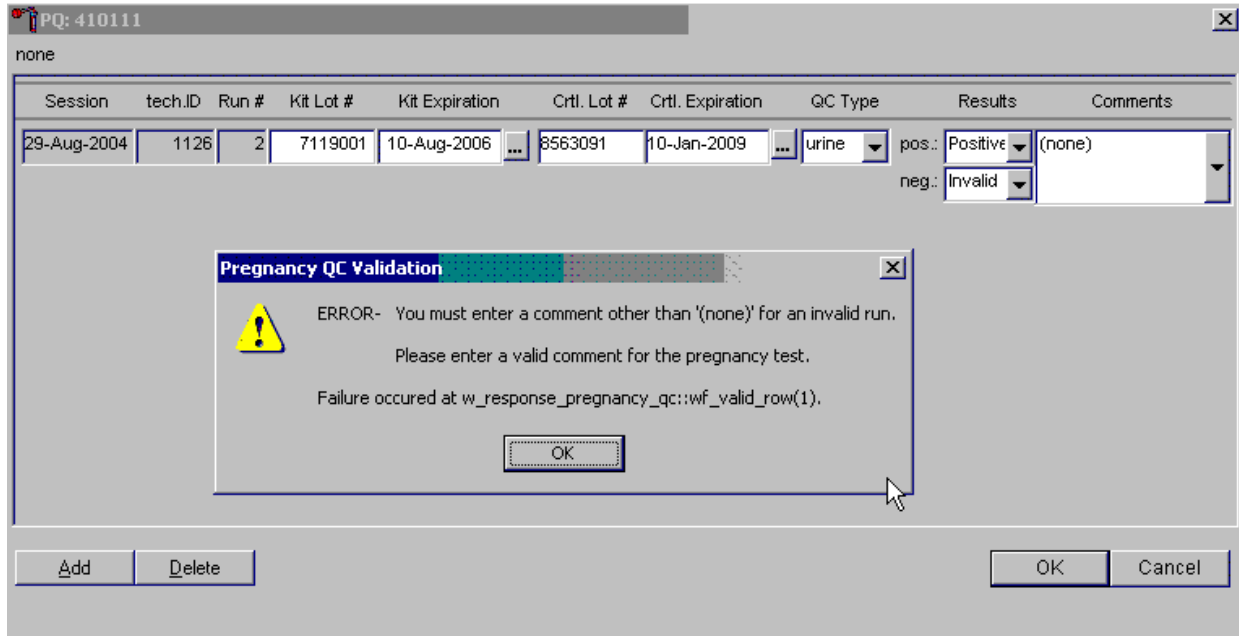

To close the box, direct the mouse arrow to the OK button and left-click or press Enter.

Enter a comment for any result that is inconsistent with expected results.

Session	tech.ID	Run #	Kit Lot #	Kit Expiration	Ctrl. Lot #	Ctrl. Expiration	QC Type	Results	Comments
29-Aug-2004	1126	2	7119001	10-Aug-2006	8563091	10-Jan-2009	urine	pos.: Positive neg.: Invalid	(none) no additional test kit opened new test kit s repeat negative contro repeat positive contro

Enter the appropriate comment in the “Comments” column by directing the mouse arrow to the drop-down list, left-click to display the choices, drag the mouse arrow to the most appropriate choice, and left-click when the correct choice is highlighted. Alternatively, use the up and down keyboard arrows to scroll through the choices or type the first letter of the desired comment code.

Review the comment.

none

Session	tech.ID	Run #	Kit Lot #	Kit Expiration	Cntl. Lot #	Cntl. Expiration	QC Type	Results	Comments
29-Aug-2004	1126	2	7119001	10-Aug-2006	8563091	10-Jan-2009	urine	pos: Positive neg: Invalid	repeat negative cont

Add Delete OK Cancel

Review all the information in the QC window to verify its accuracy.

Add a new QC record and repeat the control for invalid or unexpected results.

Session	tech.ID	Run #	Kit Lot #	Kit Expiration	Ctrl. Lot #	Ctrl. Expiration	QC Type	Results	Comments
29-Aug-2004	1126	2	7119001	10-Aug-2006	8563091	10-Jan-2009	urine	pos.: Positive neg.: Invalid	repeat negative conti
29-Aug-2004	1126	3	7119001	10-Aug-2006	8563091	10-Jan-2009	urine	pos.: Positive neg.: Negative	(none)

Rerun or repeat the control that demonstrated the unexpected result. Add a new test line to record the new control results. To add a new QC test line, direct the mouse arrow to the Add button and left-click. Record the new results. If this resolves the inconsistency, direct the mouse arrow to the OK button and left-click to save these results and to proceed with pregnancy testing.

If this does not resolve the situation, repeat the procedure with a different lot of controls. If this fails to resolve the problem, discard the entire lot of pregnancy test kits and test a new lot.

Add a new test line each time a control is run during a session and remember to record the serum QC each time it is performed.

none

Session	tech.ID	Run #	Kit Lot #	Kit Expiration	Crtl. Lot #	Crtl. Expiration	QC Type	Results	Comments
29-Aug-2004	1126	2	7119001	01-Jul-2006	678454	18-Nov-2008	urine	pos: Positive neg: Negative	(none)
29-Aug-2004	1126	3	7119001	01-Jul-2006	789612	26-Dec-2008	serum	pos: Not Done neg: Not Done	(none)

Buttons: Add, Delete, OK, Cancel

To add a new QC test line, direct the mouse arrow to the Add button and left-click. The QC type defaults to “Urine.” Correct the control lot number and expiration date. To change the QC type to serum, direct the mouse arrow to the drop-down list, drag the mouse arrow to serum, and left-click.

Record the serum control results.

none

Session	tech.ID	Run #	Kit Lot #	Kit Expiration	Crtl. Lot #	Crtl. Expiration	QC Type	Results	Comments
29-Aug-2004	1126	2	7119001	01-Jul-2006	678454	18-Nov-2008	urine	pos.: Positive (none) neg.: Negative	
29-Aug-2004	1126	3	7119001	01-Jul-2006	789612	26-Dec-2008	serum	pos.: Positive (none) neg.: Negative	

Add Delete OK Cancel

If the positive and negative serum controls demonstrate the expected result, direct the mouse arrow to the OK button and left-click to save these results and proceed with pregnancy testing. If the positive and/or the negative serum controls fail to demonstrate the expected result(s), add a new QC record, and repeat the control.

5.11 Interpretation of Results and Remedial Action

ICON® 25 hCG Test

Figures 5-1 through 5-4 respectively depict the ICON 25 test device, a positive result, a negative result, and an invalid result.

Figure 5-1. ICON 25 test device

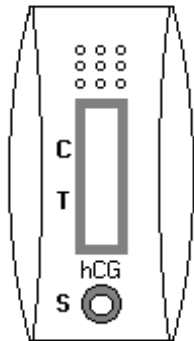
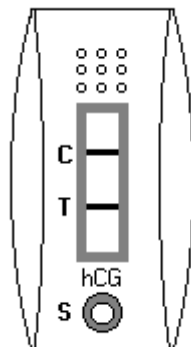
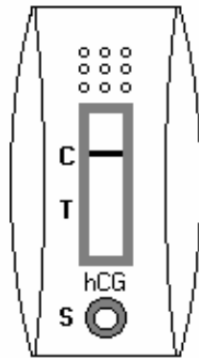

Figure 5-2. Positive result



Two distinct red lines appear. One line should be in the control region (C) and another line should be in the test region (T).

Figure 5-3. Negative result



One red line appears in the control region (C). No apparent red or pink line appears in the test region.

Figure 5-4. Invalid result

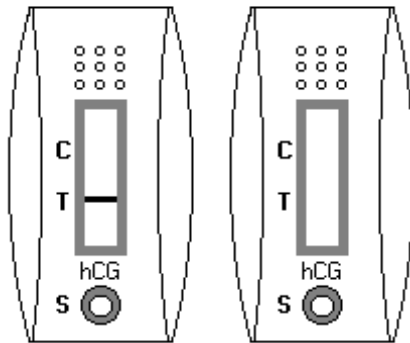

Control line fails to appear.

Positive Result. A specimen that produces two distinct red lines is positive for the presence of hCG. One line should be in the control region (C) and another line should be in the test region (T).

Negative Result. A specimen that does produce a red line appears in the control region (C) or no apparent red or pink line in the test region is negative for the presence of hCG.

Invalid Result (any of the following). For the test to be valid, a red line must appear in the control region (C). Insufficient sample volume or incorrect procedural techniques are the most likely reasons for control line failure. Review the procedure and repeat the test with a new test device. If the problem persists, discontinue using the test kit and immediately contact the technical supervisor.

If an invalid test result occurs repeatedly, or if you need technical assistance, contact the Technical Support Department at Beckman Coulter.

Sure-View™ hCG Urine and Serum Control Sets

Positive Result. The 25 mIU/ml hCG positive urine and serum controls should produce positive results.

Negative Result. The negative urine and serum control should produce a negative result.

5.12 Record Results

Use the heads-up display and the Pregnancy Testing module to enter the results of the ICON® 25 hCG test kit pregnancy test result for each SP.

Use the heads-up display to access the Pregnancy Testing module. Note that the first urine collection must be marked as verified for the pregnancy testing module to enable on the heads-up display and on the right-click menu.

Lab Sink							File View Utilities Quality Control Reports Modules Shipping Window Help							
SP ID	Sample ID	Status	Type	Gender	Age	Name	Process Status					HPV		
							UC	U	P	CB	B	PC	F	M
329869	329869	SC	P	F	12	HOWARD, CHARLES S	●	●	○	○	○	○	-	-
386827	386827	SC	P	F	26	DEEGAN, DOU	○	○	○	○	○	-	○	-
416714	416714	SC	P	F	16	JAILEY, ANTHC	○	○	○	○	○	○	○	-
499508	499508	SC	P	F	5	DEEGAN, MAR	○	○	-	○	○	-	-	-
525757	525757	SC	P	M	3	LAST NAME, P	○	○	-	○	○	-	-	-
745052	745052	SC	P	F	12	TIM, SP FIRST	○	○	○	○	○	-	-	-
767995	767995	SC	P	F	39	NAME, LAST M	○	○	○	○	○	-	○	-
836040	836040	SC	P	M	54	TORRES, LUCAS T	○	○	-	○	○	-	-	○
849425	849425	SC	P	F	16	CAMPBELL, VINNIE N	○	○	○	○	○	○	○	-
919919	919919	SC	P	M	57	PAYNE, IMA L	○	○	-	○	○	○	-	○

To access the Pregnancy Testing module, direct the mouse arrow to the correct SP, right-click, drag the mouse arrow to Pregnancy Testing, and left-click. Alternatively, use the up and down keys to move up and down the list until the correct SP is highlighted, right-click, drag the mouse arrow to Pregnancy Testing, and left-click.

The Pregnancy Testing window displays.

SP ID	Person Name	Gender	Age	Test Results
215591	PATEL, PAVARTI	F	59	(none)
900081	ABBOTT, HANNAH	F	49	(none)

The text is black for SPs who have urine collection results recorded as “Yes” or “Yes/QNS.” The text is gray for SPs who do not have urine collection results recorded. The window lists the SP ID, Person Name, Gender, and Age and includes a Test Results column (text box).

Report the results for each SP as positive, negative, not done, or invalid.

The screenshot shows a software window titled "PT: 410111". Inside the window is a table with the following columns: SP ID, Person Name, Gender, Age, and Test Results. The table contains two rows of data. The first row is highlighted, and a dropdown menu is open for the "Test Results" column of this row. The dropdown menu lists the following options: (none), (none), invalid, negative, not done, and positive. At the bottom of the window, there are three buttons: Save, OK, and Cancel.

SP ID	Person Name	Gender	Age	Test Results
215591	PATEL, PAVARTI	F	59	(none)
900081	ABBOTT, HANNAH	F	49	(none)

If the Test Result field is black or highlighted, record the result by typing [P/p] for positive, [N/n] for negative, or [I/i] for an invalid result. Enter [N/n] for “not done” when the test is not performed. Alternatively, to record a result, direct the mouse arrow to the drop-down list, drag the arrow to the correct choice, and left-click. To update the results without exiting the window, direct the mouse arrow to the Save button and left-click. To update the results and exit the window, direct the mouse arrow to the OK button and left-click or select Enter. To exit the module without saving any result, direct the mouse arrow to the Cancel button and left-click.

Continue performing pregnancy tests and recording the results. Save the test results after entering each positive, negative, or invalid result. To update the results without exiting the window, direct the mouse arrow to the Save button and left-click. To update the results and exit the window, direct the mouse arrow to the OK button and left-click or select Enter. To exit the module without saving any result, direct the mouse arrow to the Cancel button and left-click.

A series of message boxes displays to inform that an SP has been excluded (blocked) or is eligible (unblocked.) After each negative result is saved to the database, an unblocking message box displays.

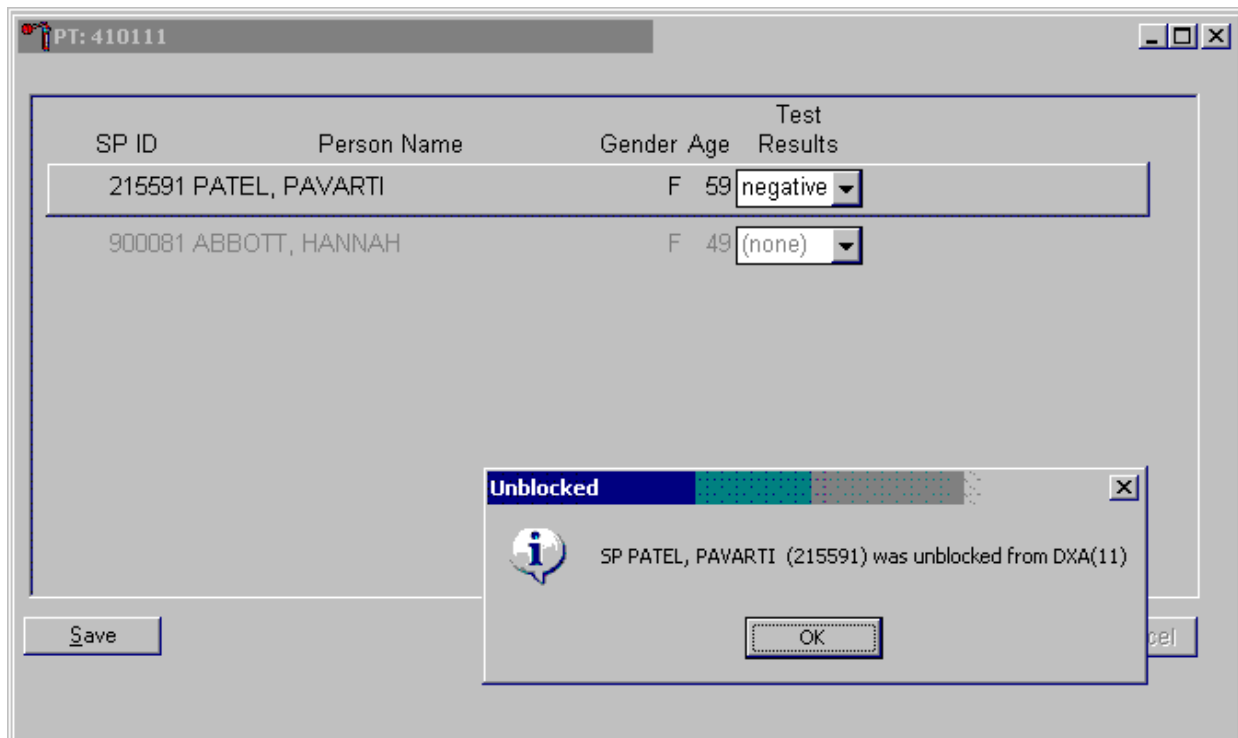

To remove the informational message box, direct the mouse arrow to the OK button and left-click, or select Enter.

As each positive result is saved to the database, a blocking message displays.

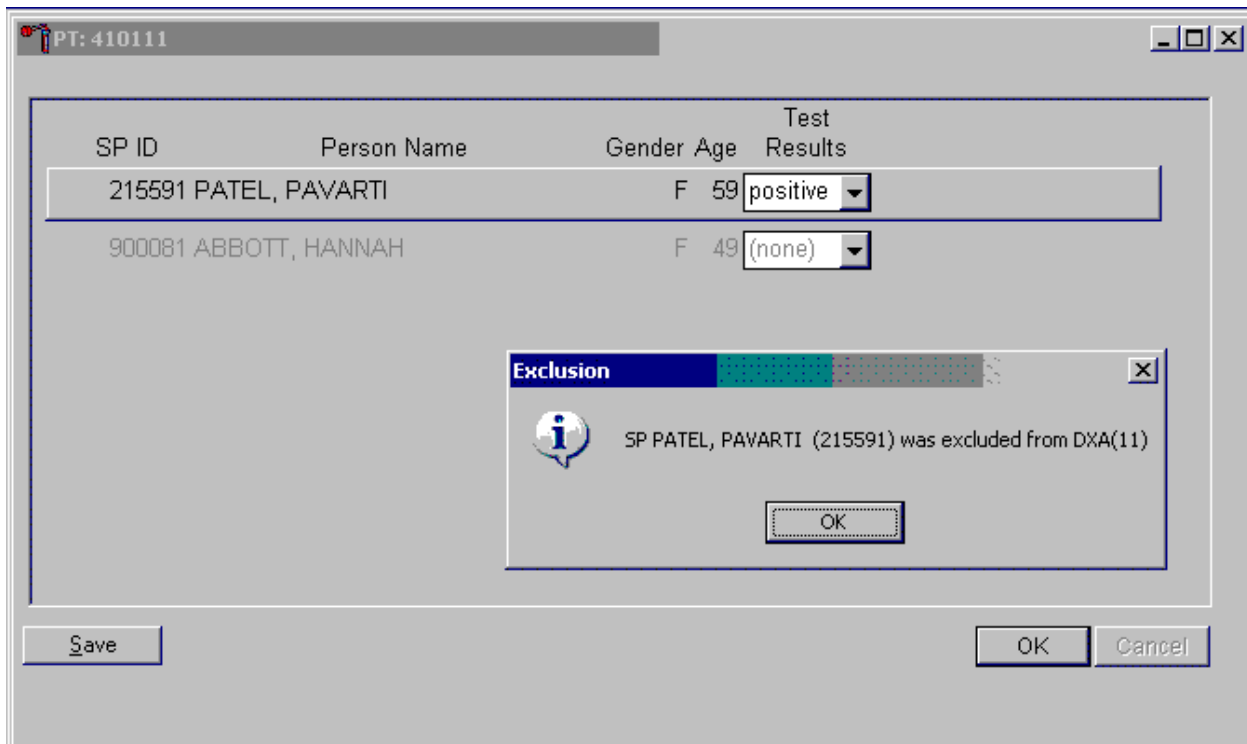

To remove the informational message box, direct the mouse arrow to the OK button and left-click, or select Enter.

If a urine pregnancy test is positive on any female SPs aged 8-17 years, perform a supplemental qualitative serum pregnancy test using serum. An informational pop-up box displays as a reminder to perform the supplemental (confirmation) test.

The screenshot shows a window titled 'PT: 410111' with a table of patient data. The table has columns for SP ID, Person Name, Gender, Age, and Test Results. The data is as follows:

SP ID	Person Name	Gender	Age	Test Results
215591	PATEL, PAVARTI	F	59	positive
762731	BROWN, LAVENDAR	F	12	positive
900081	ABBOTT, HANNAH	F	49	(none)

Below the table is a 'Save' button. A 'Pregnancy Testing' pop-up window is overlaid on the table, containing a warning icon and the text: 'Please perform a confirmation pregnancy test and document the results using the observation module.' An 'OK' button is visible at the bottom of the pop-up.

To remove the informational message box, direct the mouse arrow to the OK button and left-click, or select Enter.

If no blood is drawn, repeat the urine test. **Notify the physician of positive or negative results obtained from the supplemental serum testing, repeat urine test, or the inability to perform a follow-up test using the observation function.**

Access the observation function to send an observation to the physician.

The screenshot shows the Lab Sink software interface. The 'Utilities' menu is open, and 'Observations' is highlighted. The main window displays a table of patient data with columns for SP ID, Gender, Age, Name, Process Status, and HPV.

SP ID	Gender	Age	Name	Process Status						HPV	
				UC	U	P	CB	B	PC	F	M
329869	F	12	HOWARD, CHARLES S	<input type="radio"/>	<input type="radio"/>	<input type="radio"/>	<input type="radio"/>	<input type="radio"/>	<input type="radio"/>	-	-
386827	F	26	DEEGAN, DOUG O	<input type="radio"/>	<input type="radio"/>	<input type="radio"/>	<input type="radio"/>	<input type="radio"/>	-	<input type="radio"/>	-
416714	F	16	BAILEY, ANTHONY J	<input type="radio"/>	<input type="radio"/>	<input type="radio"/>	<input type="radio"/>	<input type="radio"/>	<input type="radio"/>	<input type="radio"/>	-
499508	F	5	DEEGAN, MARK	<input type="radio"/>	<input type="radio"/>	-	<input type="radio"/>	<input type="radio"/>	-	-	-
525757	M	3	LAST NAME, PAT M	<input type="radio"/>	<input type="radio"/>	-	<input type="radio"/>	<input type="radio"/>	-	-	-
745052	F	12	TIM, SP FIRST NAME M	<input type="radio"/>	<input type="radio"/>	<input type="radio"/>	<input type="radio"/>	<input type="radio"/>	-	-	-
767995	F	39	NAME, LAST M	<input type="radio"/>	<input type="radio"/>	<input type="radio"/>	<input type="radio"/>	<input type="radio"/>	-	<input type="radio"/>	-
836040	M	54	TORRES, LUCAS T	<input type="radio"/>	<input type="radio"/>	-	<input type="radio"/>	<input type="radio"/>	-	-	<input type="radio"/>
849425	F	16	CAMPBELL, VINNIE N	<input type="radio"/>	<input type="radio"/>	<input type="radio"/>	<input type="radio"/>	<input type="radio"/>	<input type="radio"/>	<input type="radio"/>	-
919919	M	57	PAYNE, IMA L	<input type="radio"/>	<input type="radio"/>	-	<input type="radio"/>	<input type="radio"/>	<input type="radio"/>	-	<input type="radio"/>

To send an observation to the physician, direct the mouse arrow to Utilities in the top menu bar, drag the mouse arrow to Observations, and left-click.

Select or highlight the correct SP.

The screenshot shows the Lab Sink software interface. At the top is a menu bar with 'File', 'View', 'Utilities', 'Quality Control', 'Reports', 'Modules', 'Shipping', 'Window', and 'Help'. Below the menu bar is a toolbar with various icons. The main area contains a table with columns: SP ID, Sample ID, Status, Type, Gender, Age, Name, Process Status (UC, U, P, CB, B, PC), and HPV (F, M). The table lists several SPs, with the third one highlighted. An 'SP Observation' dialog box is open over the third row, showing a list of SPs with their names and ages. The first entry in the dialog is '256339 SMITH, 15M J' with age '15'. Other entries include '329869 SMITH, 39F S' (39), '416714 SMITH, 29M J' (29), '480354 SMITH, 34M S' (34), '525757 SMITH, 19M L' (19), '545182 SMITH, 11F H' (11), '836040 SMITH, 38M S' (38), and '837622 SMITH, 27F L' (27). A mouse cursor is pointing at the '836040' entry in the dialog.

SP ID	Sample ID	Status	Type	Gender	Age	Name	Process Status						HPV			
							UC	U	P	CB	B	PC	F	M		
329869	329869	SC	P	F	12	HOWARD, CHARLES S	<input type="radio"/>	<input type="radio"/>	<input type="radio"/>	<input type="radio"/>	<input type="radio"/>	<input type="radio"/>	<input type="radio"/>	<input type="radio"/>	-	-
386827	386827	SC	P	F	26	DEEGAN DOUG O	<input type="radio"/>	<input type="radio"/>	<input type="radio"/>	<input type="radio"/>	<input type="radio"/>	<input type="radio"/>	<input type="radio"/>	<input type="radio"/>	-	-
416714	416714	SC	P	F			<input type="radio"/>	<input type="radio"/>	<input type="radio"/>	<input type="radio"/>	<input type="radio"/>	<input type="radio"/>	<input type="radio"/>	<input type="radio"/>	-	-
499508	499508	SC	P	F			<input type="radio"/>	<input type="radio"/>	<input type="radio"/>	<input type="radio"/>	<input type="radio"/>	<input type="radio"/>	<input type="radio"/>	<input type="radio"/>	-	-
525757	525757	SC	P	M			<input type="radio"/>	<input type="radio"/>	<input type="radio"/>	<input type="radio"/>	<input type="radio"/>	<input type="radio"/>	<input type="radio"/>	<input type="radio"/>	-	-
745052	745052	SC	P	F			<input type="radio"/>	<input type="radio"/>	<input type="radio"/>	<input type="radio"/>	<input type="radio"/>	<input type="radio"/>	<input type="radio"/>	<input type="radio"/>	-	-
767995	767995	SC	P	F			<input type="radio"/>	<input type="radio"/>	<input type="radio"/>	<input type="radio"/>	<input type="radio"/>	<input type="radio"/>	<input type="radio"/>	<input type="radio"/>	-	-
836040	836040	SC	P	M			<input type="radio"/>	<input type="radio"/>	<input type="radio"/>	<input type="radio"/>	<input type="radio"/>	<input type="radio"/>	<input type="radio"/>	<input type="radio"/>	-	-
849425	849425	SC	P	F			<input type="radio"/>	<input type="radio"/>	<input type="radio"/>	<input type="radio"/>	<input type="radio"/>	<input type="radio"/>	<input type="radio"/>	<input type="radio"/>	-	-
919919	919919	SC	P	M			<input type="radio"/>	<input type="radio"/>	<input type="radio"/>	<input type="radio"/>	<input type="radio"/>	<input type="radio"/>	<input type="radio"/>	<input type="radio"/>	-	-

To select or highlight an SP, drag the mouse arrow to the correct SP and left-click. Verify that the SP ID, name, and age are correct. Use the vertical scroll bar to view the complete list of SPs. To continue, direct the mouse arrow to the OK button and left-click or select Enter. To cancel these actions and exit the observation function, direct the mouse arrow to the Cancel button and left-click.

The observation text window displays.

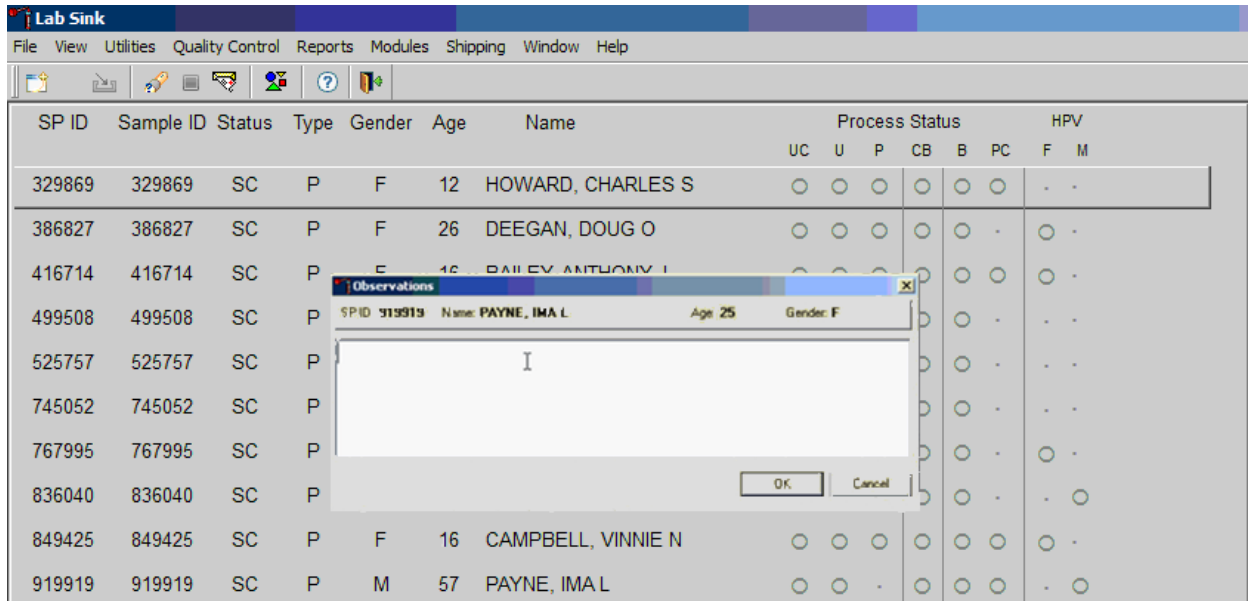

The observations text window contains the SP ID, name, age, and gender. Type the observation in this window using the keyboard. To send the observation to the physician, direct the mouse arrow to the OK button and left-click. To cancel these actions or to exit the window without entering an observation, direct the mouse arrow to the Cancel button and left-click.

Send an observation to report a negative serum test result on SPs aged 8-17 years.

The observations window contains the SP ID, name, age, and gender. Type the observation, “The serum hCG test is negative,” using the keyboard. To send the observation to the physician, direct the mouse arrow to the OK button and left-click. To cancel these actions or to exit the observations window without entering an observation, direct the mouse arrow to the Cancel button and left-click.

Send an observation to report a positive serum test result on SPs aged 8-17 years.

The observations window contains the SP ID, name, age, and gender. Type the observation, “The serum hCG test is positive,” in this window. To send the observation to the physician, direct the mouse arrow to the OK button and left-click or select Enter. To cancel these actions, or to exit the observations window without entering an observation, direct the mouse arrow to the Cancel button and left-click.

Send an observation to report the inability to perform the serum test and to report the results of a repeat negative urine test on female SPs aged 8-17 years.

The observations window contains the SP ID, name, age, and gender. Type the observation, “There is no serum available on this SP. The lab is unable to perform a serum hCG test. The repeat urine hCG test is negative” in this window using the keyboard. To send the observation to the physician, direct the mouse arrow to the OK button and left-click or select Enter. To cancel these actions or to exit the observations window without entering an observation, direct the mouse arrow to the Cancel button and left-click.

Send an observation to report the inability to perform the serum test and to report the results of a repeat positive urine test on female SPs aged 8-17 years.

The observations window contains the SP ID, name, age, and gender. Type the observation, “There is no serum available on this SP. The lab is unable to perform a serum hCG test. The repeat urine test is positive” in this window using the keyboard. To send the observation to the physician, direct the mouse arrow to the OK button and left-click or select Enter. To cancel these actions or to exit the observations window without entering an observation, direct the mouse arrow to the Cancel button and left-click.

Send an observation to report the inability either to perform the serum test or to repeat the urine test on female SPs aged 8-17 years.

The observations window contains the SP ID, name, age, and gender. Type the observation, “There is no serum or urine on this SP. The lab is unable to perform either a repeat urine or serum hCG test” in this window using the keyboard. To send the observation to the physician, direct the mouse arrow to the OK button and left-click or select Enter. To cancel these actions or to exit the observations window without entering an observation, direct the mouse arrow to the Cancel button and left-click.

The physician reviews all observations.

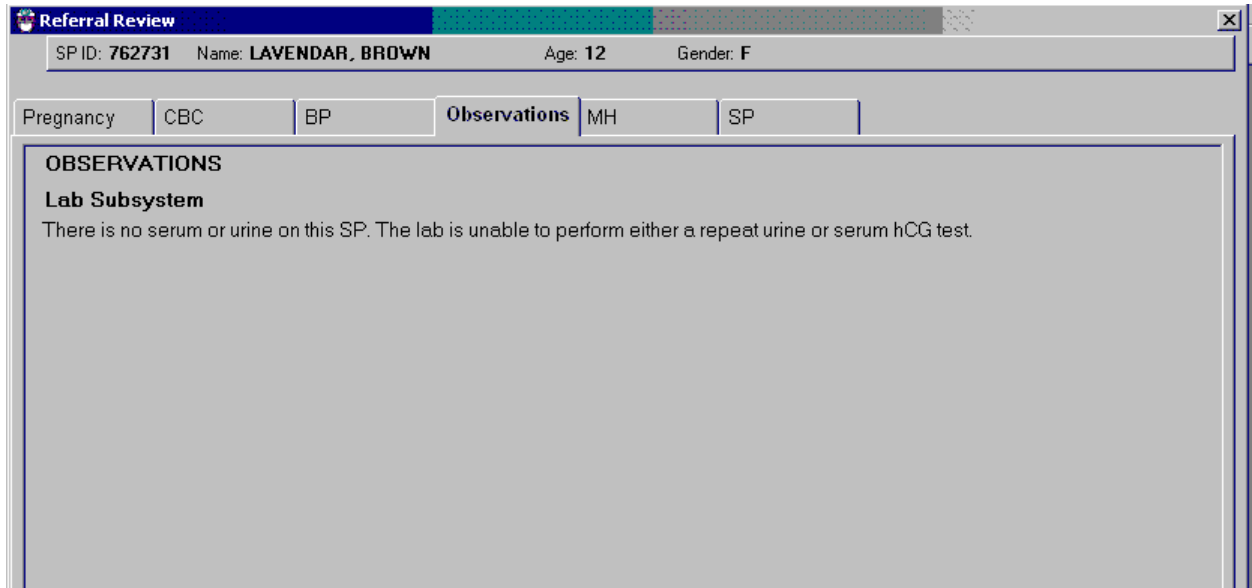

The screenshot shows a software window titled "Referral Review". At the top, it displays patient information: "SP ID: 762731", "Name: LAVENDAR, BROWN", "Age: 12", and "Gender: F". Below this is a tabbed interface with five tabs: "Pregnancy", "CBC", "BP", "Observations", and "MH", with "Observations" currently selected. The main content area under the "Observations" tab is titled "OBSERVATIONS" and contains a section labeled "Lab Subsystem" with the text: "There is no serum or urine on this SP. The lab is unable to perform either a repeat urine or serum hCG test."

The physician accesses the observations using the Review in Box Details.

5.13 Limitations of Method: Specimen Rejection, Interfering Substances, and Conditions

Read the following procedural notes to ensure the best results with the ICON® 25 hCG test kit.

ICON® 25 hCG Test

- **Dispensing specimen.** Do not reuse a test device or use a test device for multiple patient samples or controls, as this will produce inaccurate results.
- **Incubation times.** The intensity of the red color in the test line region (T) will vary depending on the concentration of hCG present in the sample. However, neither the qualitative value nor the rate of increase in hCG can be determined by this qualitative test.
- **Batch processing.** If several specimens are to be tested during one run, perform each test step for all specimens and controls at timed intervals before proceeding to the next test step. It is recommended that no more than ten (10) test devices be run in one batch.
- **Specimens containing particulate matter.** Urine samples exhibiting visible precipitates should be allowed to settle to obtain a clear sample for testing.

- **Very dilute urine samples**, as indicated by a low specific gravity, may not contain representative levels of hCG.
- **False negative results** may occur when the levels of hCG are below the sensitivity level of the test.
- **Very low levels of hCG** (less than 50 mIU/mL) are present in urine and serum samples shortly after implantation. However, because a significant number of first trimester pregnancies terminate for natural reasons, a test result that is weakly positive should be confirmed.
- **A number of conditions** other than pregnancy, including trophoblastic disease and certain nontrophoblastic neoplasms including testicular tumors, prostate cancer, breast cancer, and lung cancer, cause elevated levels of hCG. Therefore, the presence of hCG in urine or serum should not be used to diagnose pregnancy unless these conditions have been ruled out.
- **This test provides a presumptive diagnosis for pregnancy.** A physician should make a confirmed pregnancy diagnosis only after all clinical and laboratory findings have been evaluated.
- **Negative results are expected in healthy nonpregnant women and healthy men.** Healthy pregnant women have hCG in their urine and serum samples. The amount of hCG will vary greatly with gestational age and between individuals. Concentrations of hCG in pregnant women are generally between 10 and 30 mIU hCG/m in the 7-10 days following implantation or 3 weeks after the last menstrual period (LMP). During the latter part of the first trimester of pregnancy, the hCG concentration reaches a maximum level of greater than 100,000 mIU/mL.
- **The ICON® 25 hCG test** has a stated sensitivity of 25 mIU/ml and is capable of detecting pregnancy as early as 1 day after the first missed menses.

Sure-View™ hCG Urine and Serum Control Sets

These controls are formulated for use as quality control specimens in the reagent verification of pregnancy test kits.

Accuracy, Sensitivity, and Specificity: ICON® 25 hCG Test

Accuracy. A multicenter clinical evaluation was conducted comparing the results obtained using the ICON® 25 hCG test and another commercially available urine/serum membrane hCG test. The urine study included 159 samples and both tests identified 88 negative and 71 positive results. The serum study included 73 samples, and both assays identified 51 negative and 21 positive and 1

inconclusive result. The results demonstrated a 100 percent overall agreement (for an accuracy of >99%) of the ICON® 25 hCG test when compared to the other urine/serum membrane hCG test, as shown in Exhibit 5-1.

Exhibit 5-1. Comparison of hCG tests

		Commercially available test	
		Positive	Negative
ICON® 25 hCG Urine	Positive	71	0
	Negative	0	88
		Commercially available test	
		Positive	Negative
ICON® 25 hCG Serum	Positive	21	0
	Negative	0	51

Sensitivity. The ICON® 25 hCG test detects hCG at concentrations of 25 mIU hCG/ml or greater. The test has been standardized to the World Health Organization (WHO) Third International Standard. The addition of 300 mIU/ml of luteinizing hormone, (LH), 1,000 mIU/ml of follicle stimulating hormone (FSH), and 1,000 mIU/ml of thyroid stimulating hormone (TSH) to negative (0 mIU/ml hCG) urine/serum specimens and to positive (25 mIU/ml hCG) urine/serum specimens did not exhibit cross-reactivity in the assay.

Specificity. The following potentially interfering substances were added to hCG negative and positive samples, as shown in Exhibit 5-2. None of the substances at the concentrations tested interfered in the test.

Exhibit 5-2. Interfering substances

Substance added	Concentration (mg/dL unless noted)
Acetaminophen	20
Acetone	1,000
Acetylsalicylic Acid	20
Acetoacetic Acid	2,000
Ampicillin	20
Ascorbic Acid	20
Atropine	20
Albumin	2,000
B-Hydroxybutyrate salt	2,000
Benzoylcegonine	10
Bilirubin	20
Brompheniramine	20
Caffeine	20
Cannabinol	10
Clomiphene	100
Cocaine	10
Codeine	10
Cholesterol	500
Creatine	20
Dextromethorphan	20
DMSO	5%
EDTA	80
Ephedrine	20
Ethanol	1%
Estriol	2
Estrone 3-Sulfate	10
Gentisic Acid	20
Glucose	2000
Hemoglobin	1,000
Heroin	1
Ibuprofen	20
Methadone	10
Methamphetamine	10
Methanol	10%
Morphine	0.6
Oxalic Acid	40
Phenothiazine	20
Phenylpropanolamine	20
Pregnanediol	2
Salicylic Acid	20
Tetracycline	20
Triglycerides	1,200
Theophylline	20
Urea	2,000
Urea	20

Sure-View™ hCG Urine and Serum Controls

These controls have been designed to produce correct results in pregnancy test kits. These controls have been tested with the ICON® 25 hCG test and were found to produce satisfactory results.

5.14 Reference Ranges

Not applicable.

5.15 Action Limits

Not applicable.

5.16 Specimen Storage and Handling During Testing

Serum. Serum is required; do not use plasma. Specimens may be stored for 48 hours at 2°C-8°C (36°F-46°F) before testing. Specimens held for longer times should be frozen at -20°C (-4°F) before testing. Bring all specimens to room temperature before beginning the assay procedure and mix before testing. Use clear non-hemolyzed samples when possible.

Urine. A urine sample must be collected in a clean and dry container. Urine samples exhibiting visible precipitates should be allowed to settle to obtain a clear sample for testing.

5.17 Alternative Method for Performing Test or Storing Specimens if Test System Fails

There is no alternative method for testing.

5.18 Test Results Reporting System Protocol for Reporting Action Limits

Not applicable.

5.19 Specimen Accountability and Tracking

All records, including QA/QC data, are maintained for 6 years. Use only numerical identifiers for SP results.

5.20 Quality Control Summary Statistics and Graphs

Quality control reports are monitored by stand and maintained for 6 years.

5.21 References

- Batzer, F.R. (1980). Hormonal evaluation of early pregnancy, *Fertil. Steril.*, 34(1), 1-13.
- Beckman Coulter, Inc. (2010, October). Product Instructions ICON 25 hCG, ©2010 Beckman Coulter, Inc.: Brea, CA 92821.
- Braunstein, G.D., Rasor, J., Adler, J., and Danzer, H. (1976). ME Wade Serum human chorionic gonadotropin levels throughout normal pregnancy, *AM. J. Obstet. Gynecol.*, 126(6), 678-681.
- Braunstein, G.D., Vaitukaitis, J.L., Carbone, P.P., and Ross, G.T. (1973). Ectopic production of human chorionic gonadotropin by neoplasms, *Ann. Intern. Med.*, 78(1), 39-45.
- Catt, K.J., Dafau, M.L., and Vaitukaitis, J.L. (1975). Appearance of hCG in pregnancy plasma following the initiation of implantation of the blastocyte, *J. Clin. Endocrinol. Metab.*, 40(3), 537-540.
- Dawood, M.Y., Saxeba, B.B., and Landersman, R. (1977). Human chorionic gonadotropin and its subunits in hydatiform mole and choriocarcinoma, *Obstet. Gynecol.*, 50(2), 172-181.
- Lenton, E.A., Neal, L.M., and Sulaiman, R. (1982). Plasma concentrations of human chorionic gonadotropin from the time of implantation until the second week of pregnancy, *Fertil. Steril.*, 37(6), 773-778.
- Steier, J.A., Bergsjø, P., and Myking, O.L. (1984). Human chorionic gonadotropin in maternal plasma after induced abortion, spontaneous abortion and removed ectopic pregnancy, *Obstet. Gynecol.*, 64(3), 391-394.

6.1 Introduction

A complete blood count (CBC) is performed in duplicate on all study participants (SPs) aged 1 year and older. The CBC is performed on the Coulter® DxH 800 analyzer using the SP's EDTA blood tubes, which are obtained via the phlebotomy component.

There are three Coulter DxH 800 analyzers, one for each mobile examination center (MEC). The serial numbers and system IDs are represented in Table 6-1.

Table 6-1. Coulter DxH 800 analyzers serial numbers and systems IDs

DxH 800 location	Serial number	System ID	IQAP ID
MEC 1	AU36520	3770768	32979-1-B3
MEC 2	AU32459	3702621	32979-1-B2
MEC 3	AU23263	3348667	32979-1-B1

6.2 Purpose and Principle of Test

The UniCel DxH 800 analyzer is a quantitative, automated hematology analyzer for in-vitro diagnostic use in screening patient populations in clinical laboratories. The UniCel DxH 800 Analyzer provides the following: CBC, Leukocyte 5-Part Differential (Diff), Reticulocyte (Retic), and Nucleated Red Blood Cell (NRBC) on whole blood.

NOTE: The NHANES study does not use the reticulocyte data, and the NRBC is used only for calculating a corrected white blood cell count.

The UniCel DxH 800 Analyzer measures the following parameters:

WBC	White Blood Cell count
UWBC	Uncorrected White Blood Cell count
RBC	Red Blood Cell count (for Whole Blood and Body Fluids)
Hgb	Hemoglobin
Hct	Hematocrit
MCV	Mean Corpuscular Volume
MCH	Mean Corpuscular Hemoglobin
MCHC	Mean Corpuscular Hemoglobin Concentration
RDW	Red Cell Distribution Width
RDW-SD	Red Cell Distribution Width Standard Deviation (SD)
PLT	Platelet count
MPV	Mean Platelet Volume
NE	Neutrophil percent
LY	Lymphocyte percent
MO	Monocyte percent
EO	Eosinophil percent
BA	Basophil percent
NE#	Neutrophil absolute number
LY#	Lymphocyte absolute number
MO#	Monocyte absolute number
EO#	Eosinophil absolute number
BA#	Basophil absolute number
NRBC	Nucleated Red Blood Cell percent
NRBC#	Nucleated Red Blood Cell absolute number
RET	Reticulocyte percent
RET#	Reticulocyte absolute number
MRV	Mean Reticulocyte Volume
IRF	Immature Reticulocyte Fraction
TNC	Total Nucleated Cell (Body Fluids)

6.2.1 Coulter Method

In 1956, Wallace Coulter described the Coulter Principle as follows: A suspension of blood cells is passed through a small orifice simultaneously with an electric current. The individual blood cells passing through the orifice introduce an impedance change in the orifice determined by the size of the cell.

Each cell suspended in a conductive liquid (diluent) acts as an insulator. As each cell passes through the aperture, it momentarily increases the resistance of the electrical path between the submerged electrodes on either side of the aperture. This causes a measurable electronic pulse. For purposes of counting, the vacuum used to pull the diluted suspension of cells through the aperture must be at a regulated volume. The number of recorded pulses indicates particle count, and the size of the electrical pulse is proportional to the cell volume. In addition, the system counts the individual cells and provides cell size distribution. The number of cells counted per sample is approximately 100 times greater than the usual microscope count, which reduces the odds of statistical error approximately 10 times.

6.2.2 VCSn Technology

Historically, Beckman Coulter analyzers housed a flow cell in a Triple Transducer Module (TTM), which was first introduced commercially in the 1980s. The TTM flow cell was the location for detection of the processed samples. The TTM produced three measurement signals—volume, conductivity, and light scatter.

The DxH 800 system replaces the TTM with the Multi-Transducer Module (MTM), which measures additional multiple angles of light scatter, a major improvement over the single light scatter measured by the TTM. All Diff, NRBC, and Retic analysis occurs in the VCSn module. The VCSn module is responsible for controlled sample preparation and delivery of the prepared sample to the flow cell for analysis of the WBC differential, reticulocyte, and NRBC. The VCSn module includes the Air Mix and Temperature Control (AMTC) and the Multi-Transducer Module (MTM).

In the flow cell, low-frequency direct current measures volume, while high-frequency (RF) current senses cellular internal content through measuring changes in conductivity.

The MTM uses a flow cell to pass particles through a sensing zone, one particle at a time, and a diode laser to illuminate the particles. The illuminated particles both scatter and absorb a portion of the incident light. Sensors strategically placed around the flow cell collect the scattered light of interest. An additional sensor placed in the laser path measures the amount of light removed due to light scatter and absorption. This measurement is called Axial Light Loss.

6.2.3 Dataplot Development

The SM performs a series of operations on the stored digital raw values received from the flow cell to identify populations and calculate the frequency of cells within each population. The system produces the dataplot displays for visual representation of the Differential, NRBC membership (types of cells), and density (concentration).

The DxH 800 system algorithm uses tools designed for finding optimal separation between overlapping clusters of data.

The algorithm can:

- Adapt to unusual population shifts and overlaps;
- Define highly irregular separation;
- Make subsequent analysis of the identified regions; and
- Correct deficiencies in separation.

In the dataplots, different colors represent different memberships. Shades of colors represent density: dark colors for low density and bright colors for high density, as shown in the following listing:

NRBC analysis		Diff analysis	
NRBC	Red	Lymphocyte	Blue
Other*	Green	Monocyte	Green
WBC	Blue	Neutrophil	Purple
		Eosinophil	Orange
		Basophil	White
		Non-White Cell	Red

* Others include RBC debris, and PLT debris, etc.

6.2.4 Parameter Measurement, Derivation, and Calculation

Exhibit 6-1 lists each reportable parameter and the method used to obtain the results. A description of the method is also included.

Exhibit 6-1. Reportable parameters and analysis methods

Parameter (reporting units in US-1 format)	Method	Description
WBC	Coulter Principle	White Blood Cell Count or Leukocyte Count <ul style="list-style-type: none"> ■ Measure directly, multiplied by the calibration factor. ■ Corrected for interference if necessary. If no correction is required, then $WBC = UWBC$. ■ $WBC = N \times 10^3 \text{ cells}/\mu\text{L}$.
UWBC	Coulter Principle	Uncorrected White Blood Cell <ul style="list-style-type: none"> ■ Measure directly, multiplied by the calibration factor. ■ $UWBC = N \times 10^3 \text{ cells}/\mu\text{L}$.
RBC	Coulter Principle	Red Blood Cell Count or Erythrocyte Count <ul style="list-style-type: none"> ■ Measure directly, multiplied by the calibration factor. ■ Corrected for very high white count if necessary. ■ $RBC = N \times 10^6 \text{ cells}/\mu\text{L}$.
Hgb	Photometric Measurement	Hemoglobin or Hemoglobin Concentration <ul style="list-style-type: none"> ■ Transmittance of light at 525 nm through a lysed WBC solution in the Hgb cuvette, compared to the transmittance of the same light through a reagent blank. The system converts this ratio to the Hgb value using a calibration factor. ■ Weight (mass) of Hgb determined from the degree of absorbance found through photo current transmittance expressed in g/dl. ■ Corrected for WBC interference. ■ $Hgb \text{ (g/dl)} = [\text{constant} \times \log^{10} (\text{Reference \%T}/\text{Sample \%T})]$.
Hct	Calculated	Hematocrit <ul style="list-style-type: none"> ■ The relative volume of packed erythrocytes to whole blood. ■ $Hct (\%) = RBC \times MCV^{10}$.
MCV	Derived from RBC Histogram	Mean Corpuscular Volume <ul style="list-style-type: none"> ■ The average volume of individual erythrocytes derived from the RBC histogram. ■ The system multiplies the number of RBC in each channel by the size of the RBC in that channel. The products of each channel between 36 and 360 femtoliters (fL) are added. This sum is divided by the total number of RBC between 36 and 360 fL. The analyzer then multiplies by a calibration factor. ■ Corrected for WBC interference. ■ Expressed in fL.

The DxH 800 system includes a Specimen Processing Module (SPM), a Pneumatic Supply Module (PSM), and an SM, precisely integrated to provide process control, data consolidation, and cassette or single-tube delivery of specimens.

6.3 Components of DxH 800

6.3.1 The Specimen Processing Module

The SPM is made up of the following functional modules:

- **Specimen Transport Module (STM).** The STM automatically transports specimens, delivering closed-vial and open-vial specimens, which accommodates a wide range of specimen tubes. The STM supports the following:
 - Operator loading and unloading of specimens;
 - Transport and queuing of specimens;
 - Mixing and presentation of specimens; and
 - A Magnetic Transport System to move cassettes containing specimens.
- **Sample Aspiration Module (SAM).** The SAM aspirates from capped specimen tubes (presented via cassette or single-tube presentation) or open vials (single-tube presentation). Body fluids are presented via single-tube, while whole bloods can be presented in either presentation mode. The identification and integrity of samples are verified prior to delivery and transfer to the analytical modules within the system. The SAM design provides for two methods of sample delivery: sample segmentation and sample dispensing. In sample segmentation, aspirated sample is transferred through the BSV where it is segmented for whole blood CBC and body fluid. In sample dispensing, whole blood sample segments are dispensed via the aspiration probe into the mixing chambers on the Air Mix Temperature Control Module (AMTC) for the WBC differential, and NRBC analyses.
- **VCSn Module.** The VCSn module provides the physical processing elements necessary for the Differential and NRBC sample preparation and subsequent measurement. This module includes the Distribution Valve (DV), Air Mix Temperature Control (AMTC) module, Multi-transducer Module (MTM) and their associated electronics and fluidics. Samples prepared at the AMTC are delivered to the MTM where the sample detection occurs.

- **CBC Assembly.** The CBC Assembly provides the physical processing elements necessary for CBC sample conditioning (combining of reagents and the sample segment, mixing, and incubation) and measurement via the aperture bath assemblies, the Hgb assembly, and the electrical signal conditioning circuits.
- Common services consist of the Electronic Supply Module, Pneumatic Services, and Reagent Services (supply and distribution). Common Services provides and monitors electronic power and supplies and monitors the reagent and waste levels as well as the pressure and vacuum.

6.3.2 The System Manager

The DxH 800 SM is responsible for the following:

- Controlling processes, such as analytic and diagnostic procedures;
- Producing test results; and
- Managing data, such as test ordering, result, review and release, quality control, LIS interface, logging, and report generation

The SM includes an LCD flat panel monitor with touch screen capability, a computer with a CD/DVD RW drive running Microsoft Windows operating system, the DxH 800 software, a standard keyboard, and an optical mouse.

6.3.3 Pneumatic Supply Module

The PSM supplies vacuum and pressure to the SPM.

6.4 Special Safety Precautions

All specimens may be potentially positive for infectious agents including HIV and Hepatitis B and C viruses. Observe standard precautions. It is mandatory to wear gloves and a lab coat when handling all human blood products and Coulter controls. Dispose of all biological samples in a biohazard container and wipe down all work surfaces with a 10% bleach solution at the end of each session.

The MEC *Working Safely with Hazardous Chemicals* manual contains all Coulter material safety data sheets (MSDS).

6.5 Computerization: Integrated Survey Information System (ISIS)

The DxH 800 SM transmits individual SP results to the MEC automated ISIS system. All SP results are reviewed at the DxH 800 SM monitor.

The ISIS hematology module in the laboratory application automatically receives the results, or results are transmitted manually to the hematology module. The laboratory application evaluates the data for completeness and accuracy. The final decision to accept or reject a result is the responsibility of the medical technologist.

All data are backed up and stored at Westat's home office.

6.6 Specimen Collection and Preparation

6.6.1 Specimen Collection

- The phlebotomist collects a 3- or 4-ml K2 EDTA (ethylene diamine-tetracetic acid) tube, used for a CBC on all SPs aged 1 year and older, following the established venipuncture protocol and procedures. (A 1-2% dilution effect occurs in this liquid EDTA tube.)
- Sample volume is 165 μ L of whole blood in the closed-vial mode or the single tube presentation mode. The minimum sample volume per tube in the closed-vial mode is 1-ml with the proper proportion of blood to anticoagulant.

6.6.2 Specimen Preparation

- For SPs 1-2 years old, the medical technologist working in the blood specimen-processing workstation initially processes the tube by first taking off whole blood required for various tests in the SP's profile. The medical technologist working in the blood specimen-processing workstation places the specimen on a rocker until the medical technologist working in the hematology workstation can perform the CBC. The CBC should be run as soon as possible; there is no requirement to wait any length of time between drawing the blood and running the CBC.
- There is a dedicated tube drawn for the CBC on SPs aged 3 years and older.
- For SPs aged 3-19, the CBC tube should be given to workstation 2 after the CBC has been resulted and reported. This tube will be spun down for the fluoride vessel.

6.7 Procedure for Microscopic Examination

Not applicable. Do not prepare differential microscopic slides.

6.7.1 Reagents and Supplies

DxH reagents, including storage and handling requirements, are listed below:

- Coulter DxH diluent (store at 2-40° C).
 - Coulter DxH diluent is shipped in ready-to-use containers.
 - Opened containers are stable for 60 days. Do not use this product beyond the expiration date.
 - Coulter DxH diluent is a cyanide-free, isotonic buffered saline solution.
 - Coulter DxH diluent dilutes the specimen, is used for rinsing SPM components between sample analyses, and provides a sheath stream to transport the specimen through the flow cell.
- Coulter DxH Lyse reagent (store at 2-40° C).
 - Coulter DxH Lyse reagent is shipped in ready-to-use containers.
 - Opened containers are stable for 60 days. Do not use this product beyond the expiration date.
 - Coulter DxH Lyse is a cyanide-free, CBC lytic reagent that lyses red blood cells for the white blood cell count and works in conjunction with Coulter DxH Diluent to generate a stable hemoglobin measurement.
 - Coulter DxH Cell Lyse is also used to lyse the red blood cells and discriminates nucleated red blood cells from white blood cells.
- Coulter DxH Diff Pack (store at 2–25° C).
 - Coulter DxH Diff Pack is shipped in ready-to-use containers.
 - Opened containers are stable for 60 days. Do not use this product beyond the expiration date.

- The Coulter DxH Diff Pack consists of the Erythrolyse Lytic reagent and StabiLyse Preservative reagent.
- The Erythrolyse Lytic reagent is a cyanide-free lytic reagent that dilutes the blood sample and lyses red blood cells in preparation for white blood cell measurement in the flow cell.
- The StabiLyse Preservative reagent neutralizes the Diff lytic reagent and preserves the white blood cells for measurement in the flow cell. Together, Erythrolyse and StabiLyse provide the five-part differential.
- Coulter DxH cleaner (store at 2–25° C).
 - Coulter DxH cleaner is shipped in ready-to-use containers.
 - Opened containers are stable for 90 days. Do not use this product beyond the expiration date.
 - DxH cleaner is a cyanide-free, aldehyde-free cleaning agent that degrades residual materials so that they may be flushed from the system with diluent.

NOTE: If any Coulter DxH reagent has been partially or completely frozen, allow the product to warm to room temperature. Mix product by gentle inversion prior to placement on the instrument.

DxH controls, including storage and handling requirements, are listed below:

- Coulter 6C cell control (store at 2–8 ° C).
 - The Coulter 6C cell control is an integrated control that enables monitoring of system performance and calibration status for all directly measured and calculated CBC, Diff, and NRBC parameters. Instructions for use are as follows:
 - Remove 6C cell control vials from refrigerator and warm at ambient temperature for 10 to 15 minutes.
 - Roll the tube slowly between the palms of the hands eight times in an upright position. Invert the tube and slowly roll between the palms of the hands eight times. Then gently invert the tube eight times. Repeat.
 - Run the controls in the cassette presentation on the instrument
 - Return the control tubes to the refrigerator within 30 minutes.
- The Coulter LIN-X Linearity control (store at 2–8° C) is recommended for verification of the reportable range and linearity, and for calibration assessment of the WBC, RBC, HGB, and PLT parameters.

- Remove Coulter Lin-X Cell control vials from refrigerator and warm at ambient temperature for 15 minutes.
- Roll the tube slowly between the palms of the hands eight times in an upright position. Invert the tube and slowly roll between the palms of the hands eight times. Then gently invert the tube eight times. Repeat mixing procedure three times.
- Run the Lin-X Cell controls in consecutive order beginning with Level 0 and ending with Level 11. Run controls in cassette presentation on the instrument.
- Level 11 is used to clean the system. The values for this level are not recorded.
- How to run linearity in the MEC:
 - Run each level under a separate repeatability—this is useful since it will calculate the mean for that level of Lin-X.
 - Print out the summary report for each level of Lin-X.
 - Write the level number on the top of each summary report.
 - Document all value on the Coulter Lin-X Control Worksheet.
 - Send worksheet, package insert, and summary reports in the end of stand box to the study manager at the home office in Rockville, MD.
- Coulter Latron CP-X control (store at 2 to 30° C) is recommended for the verification of the system calibration status of the VCSn parameters. Coulter Latron CP-X control checks the alignment of the laser and the flow cell on the DxH 800.
 - Perform daily checks prior to running Latron control.
 - Gently mix Latron CP-X control by inversion five to eight times. Avoid foaming.
 - Run the controls in the cassette presentation on the instrument.
- Coulter S-CAL[®] Calibrator is traceable to reference methods and recommended for determining adjustment factors to ensure accurate SPM measurements of directly measured CBC parameters. Calibrator results should be monitored with Coulter 6C Cell control.
 - Remove S-CAL from the refrigerator and warm at ambient temperature for 15 minutes.
 - Roll the tube slowly between the palms of the hands eight times in an upright position.

- Invert the tube and slowly roll between the palms of the hands eight times. Then gently invert the tube eight times. Repeat.
- Inspect the tube contents to determine if all cells have been uniformly distributed. Repeat the mixing procedure if contents have not been uniformly distributed.
- Complete entire procedure within 1 hour.

6.7.2 DxH 800 Supplies

- 3-ml K₂ EDTA BD Hemogard Vacutainer[®] tube (367856)
- 4-ml K₂ EDTA BD Hemogard Vacutainer[®] tube (367861)
- Tube rocker
- Bleach, 5.25% sodium hypochlorite
- Bottled deionized water
- Plastic squirt bottle
- Cotton gauze pads
- Three-hole paper punch
- Notebook
- Flashlight
- Precision screwdriver set
- CD-RW

6.8 Shutdown of DxH 800 System

The DxH 800 SPM, SM, and monitor are connected to an uninterruptible power supply (UPS). In the event of a power outage at your facility, the components will continue to operate for a short time so that you can shut down the system. The printer is connected to the back-up power supply. Shut down the SM as follows:

- Logoff. Select the Logoff utility icon,  then the Exit Workstation button.
- Shut down the operating system by using the routine Windows application.

- Power off the computer. Powering off the computer also powers off the monitor. You do not need to power off the monitor separately. The computer does not need to be shut down on a routine basis. Power off the computer only when circumstances are indicated.

6.8.1 Daily Shutdown

Beckman Coulter recommends that the SPM remain in cleaner for at least 30 minutes every 24 hours. If the SPM has power, and is in Shutdown, but the pneumatics is off, automatic cycling occurs every 24 hours to prevent flow cell and sample line clogging.

- Shutdown can be initiated manually or automatically.
- Shutdown removes diluent from the Unicel DxH 800 and replaces it with cleaner.
- At the end of the time with cleaner, the cleaner is replaced with diluent. Then, the compressor automatically shuts off.

6.8.2 Shutdown at the Mobile Examination Center

- Shutdown will be set automatically:
 - Select Calendar Icon on top of DxH monitor screen.
- From the Daily Checks screen, select the Shutdown button to display the Manual Shutdown dialog box.
 - Select Autoconfiguration at the bottom of the screen.
 - Select Configure Shutdown
 - Check Enable Automatic Shutdown: Fill in hour **07**, Min **00**.
 - Daily.
 - Make sure each of the 7 days is checked.
 - Time in cleaner **0** hour(s) **30** Minutes.
 - OK.

- Daily Checks (formerly known as StartUp) (Menu > QA > Daily Checks) is programmed to immediately follow the StartUp:
 - Select Autoconfiguration at the bottom of the screen.
 - Select Configure Daily Checks.
 - Check Enable Automatic Daily Checks.
 - Choose radio button Perform Daily Checks after Shutdown.
 - OK.
- Latron CP-X control should be run immediately following daily checks.

6.8.3 Cancel Automatic Shutdown

At certain times Automatic Shutdown will have to be cancelled. To cancel Automatic Shutdown:

- From the Daily Checks screen, select Auto Configuration.
- Select Configure Shutdown.
- Remove the check mark from the Enable Automatic Shutdown box.

To perform a manual shutdown when Auto Configuration is disabled, please see the information that follows (Section 6.8.4).

6.8.4 Manual Shutdown of DxH Units

- From the Daily Checks screen, select the Shutdown button to display the Manual Shutdown dialog box.

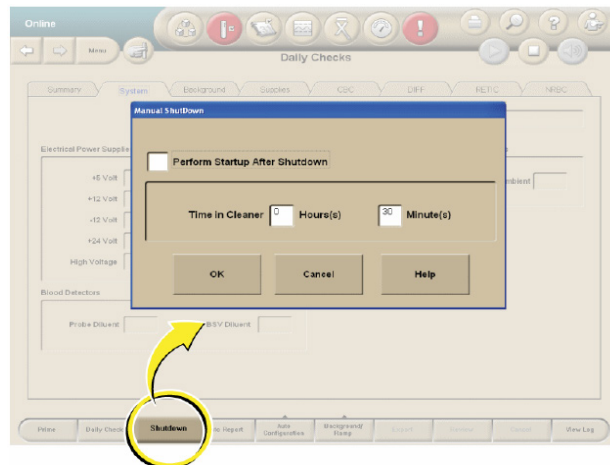

- Select the Perform Startup after Shutdown check box to automatically begin Daily Checks after Shutdown.
- Type in Time in Cleaner 0 Hours and 30 Minutes check boxes to determine the time in cleaner.
- Select OK to begin Shutdown or Cancel to exit the pop-up window without starting Shutdown.

6.9 Logon as User

Logging on to the SM:

- Click on the  icon (person with key).
- Type your user name.
- Type your password. If you forget it, ask one of the senior techs to reset it for you.

6.9.1 Entering New Operator

- Select Menu button upper left hand corner of DxH 800 screen.
- Then select **Setup** button.
- Select **Operators & Roles** button.
- Select **New Operator** button, enter all information. HINT: do not enter the password you want to use, the first time you sign on you will be asked to change your password. Under operators access you need to select Level 3 in order to do all tasks on the DxH 800.

6.10 Run Daily Checks

- Select the Daily Checks button (Calendar icon) from the top of any screen to display the Daily Checks Summary screen with results of the most recent Daily Checks.
- Obtain printout of Daily Checks from printer, initial as Reviewed by and place in Hematology Log Book.
- If Daily Checks passed all criteria, Run Latron Control.
- Running Daily Checks manually if Automatic Daily Check Failed:
 - Select the Daily Checks button (Calendar icon) from the top of any screen to display the Daily Checks Summary screen with results of the most recent Daily Checks.
 - Select the Daily Checks button at the bottom of the screen. A DxH 800 dialog box displays the following:

Are you sure you want to start a Daily Checks procedure? Press OK to continue.

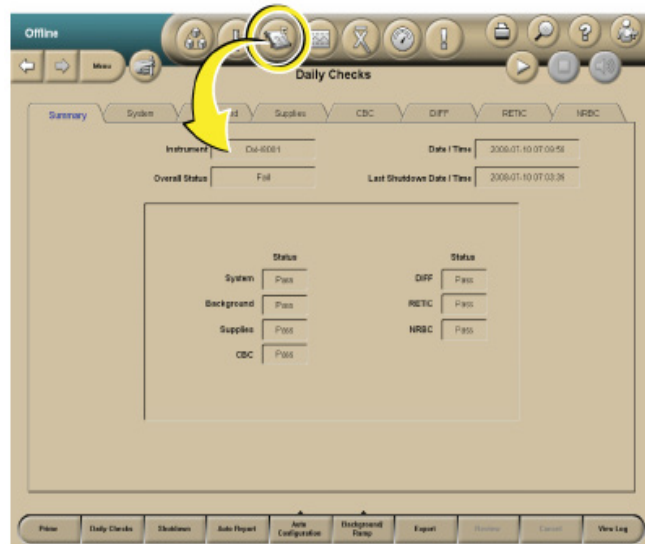

Select OK to run Daily Checks or select Cancel.

6.10.1 Daily Checks Screen

- The results of Daily Checks display on eight tabbed views: Summary (default view), System, Background, Supplies, CBC, Diff, Retic, and NRBC.
- When Daily Checks pass, the Daily Checks icon is neutral. Select the individual tabs to view those results.

If any of the Daily Checks do not pass, the following occurs:

- The Daily Checks icon is red.
- The problematic result is backlit in red on the Summary tab.
- The tab that contains the problematic result has a red indicator.
- If there are any failures, you must Review Daily Checks (Event Logs > General Tab) in order to proceed with further analysis.
- The Daily Checks must pass or be reviewed in order to run specimens.
- From any tab on the Daily Checks screen, select the Review button on the Local Navigation bar to indicate that the Daily Checks results have been reviewed.

NOTE: If Daily Checks pass, the Review button is disabled.

- You have to review only results that are questionable.
- Document on the Troubleshooting Log any action taken to troubleshoot the Daily Checks failure.

6.10.2 Additional Tasks From the Daily Checks Screen

- Select the Histogram button at the right of the screen on the DIFF, RETIC, or NRBC tabs to display the VCSn Ramp Tests Histogram screen.

NOTE: The VCSn Ramp Tests Histogram screen is not for routine use; however, you may at some time be asked to access this screen when on the phone with a Beckman Coulter representative.

- Prime the SPM.
- Prime provides a method to remove cleaner in case an error occurred during a Shutdown cycle.
- Select the Prime button at the bottom of the Daily Checks screen to prime the SPM.
- A DxH 800 dialog box will display the following message: “You have requested to perform a Prime Cycle.”
- Select OK to continue or Cancel.

6.11 Quality Control

- Quality control is the routine monitoring of performance and service using commercial or patient controls.
- Controls have known characteristics when run on a given system and are analyzed periodically in the same manner that patient specimens are analyzed.
- The results of analyzed controls are then compared to the known characteristics using statistical methods.
- This comparison allows changes in the SPM performance to be detected.
- You can then take some action if the changes detected are significant.

6.11.1 Frequency of Performing Quality Control

- Beckman Coulter 6C cell control will be run each shift, at the start of the session. The time of QC performance is set to follow the preprogrammed Daily Checks of the analyzers.
- Beckman Coulter 6C cell control is run in the cassette mode on the DxH analyzers.
- Beckman Coulter Latron CP-X control is run once each 24 hours following Daily Checks on the instrument and is run in the cassette mode on the DxH analyzers.
- Beckman Coulter Lin-X will be run once per year or at high elevation stands.
- Calibration with S-CAL will be performed at the start of every stand or when recommended to troubleshoot a problem.

6.11.2 Setting Up a Control File

- Entering 6C cell control lot numbers and expiration dates.
- Menu > QA > QC > More Options > QC Setup > New Control from Barcode > *Scan the 6C Cell Insert Barcode* > Select ALL & Auto Transmit > Select OK.

6.11.3 Setting Up a Latron Control File

- Entering Latron control lot numbers and expiration dates.
- Menu > QA > QC > More Options > QC Setup > New Control from Barcode > *Scan the Latron Insert Barcode* > Select ALL & Auto Transmit > Select OK.

6.11.4 What To Do When a Control Is Out

- When a commercial control is out:
 - Ensure that the control material was mixed properly. If not, mix it according to the package insert.
 - Verify that the control was identified properly. If using a bar code reader, ensure that the bar code labels are clean and positioned correctly. If entering the ID manually, ensure that you typed the correct information.

- Verify that the assigned set-up information (assigned values and expected ranges) matches either the control package insert or your labs established values. If they do not, contact a senior technologist to change the control's information to match.
 - If the problems above are ruled out, then rerun the control to ensure that the problem was not a statistical outlier.
 - Ensure that the control material was not contaminated by running another vial or level of control.
 - Ensure that there are no errors during the cycle. If necessary, call Beckman Coulter for help in resolution.
 - Exclude the results on any out-of-range control by checking the Exclude box when reviewing that control.
 - Document action taken in the comment tab on the Coulter screen of affected control.
- When Latron QC is out:
- Ensure that the control setup information (assigned values and expected ranges) matches the package insert. If it does not, change the control information to match the package insert, then rerun the control.
 - Ensure that the Latron control is not contaminated, is properly mixed, is not expired, and you have a sufficient volume of sample.
 - If necessary, use a new vial of control. Be sure to mix it according to the directions listed above.
 - Ensure that the flow cell is clear by performing the Flush Flow Cell procedure.
 - Rerun the control. If the control is still outside the expected ranges, call Beckman Coulter.
 - Document action taken in the comment tab on the Coulter screen of Latron Control.
 - Check the Exclude box on any Latron results that are out of range.

6.11.5 Viewing Control Files – Data View (Menu>QA>QC)

- To view control files on the Quality Control (Data View) screen, select the QC Status icon at the top of any screen.

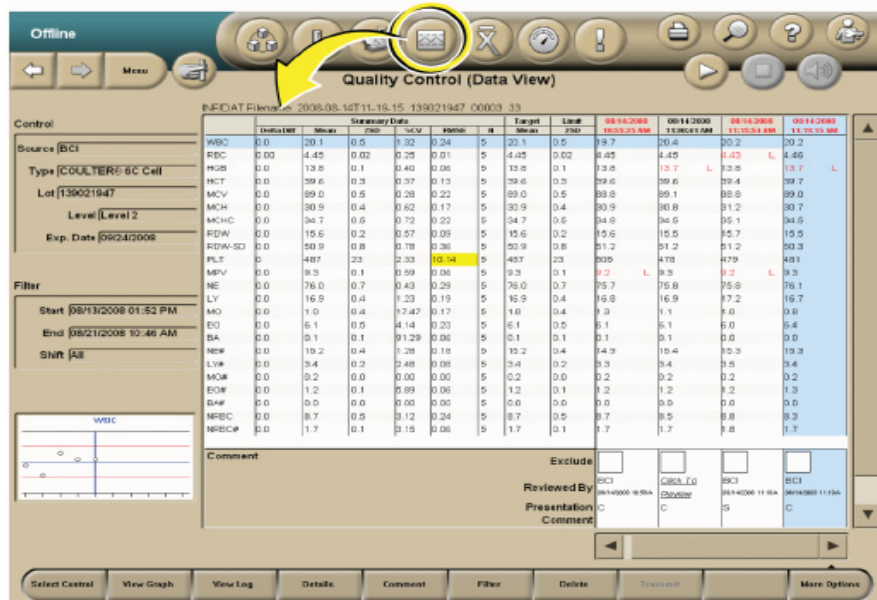

- The Quality Control–Data View screen displays the most recently analyzed control lot with the most recently analyzed run selected by default.
- If controls have not been reviewed, a dialog box displays a list of them.
- Out of control data as well as the date and time are displayed in red text.
- The Quality Control (data view) screen includes summary data, configuration data, a filter section, QC run data, run status, and one thumbnail Levy-Jennings graph for the selected parameter (row).
- The chief medical technologists will review QC on a weekly basis looking for any outlier results using the Westgard rules listed below. See examples of trends and shifts in QC data (Exhibit 6-2).

Exhibit 6-2. Examples of trends and shifts in QC data

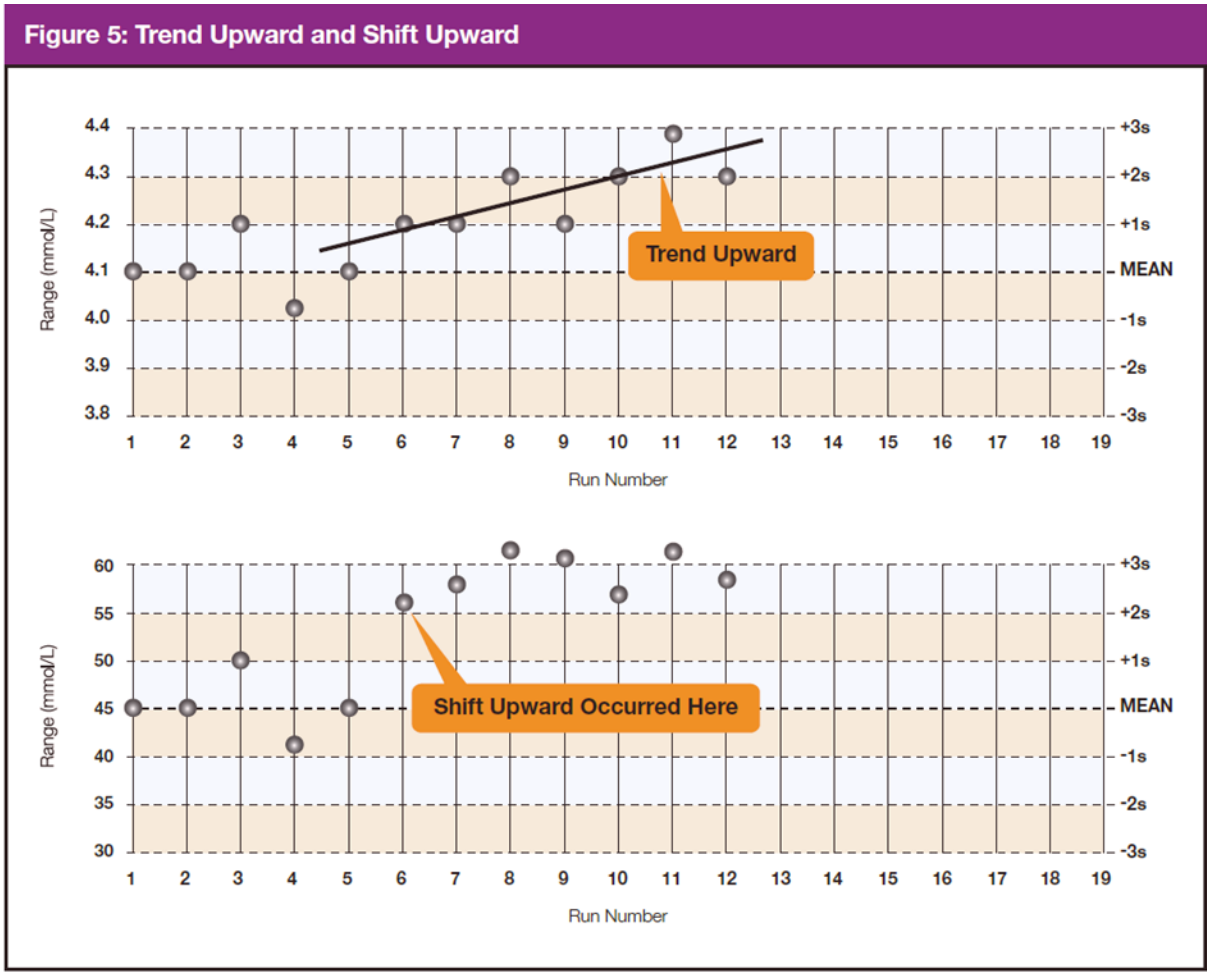

Exhibits 6-3 through 6-7 present the Westgard rules as mentioned earlier.

Exhibit 6-3. Westgard Rule 1_{2s}

Rule 1_{2s} . A single control measurement exceeds 2 standard deviations (SD) of control limits either above or below the mean. This rule is used as a warning rule to trigger careful inspection of the control data.

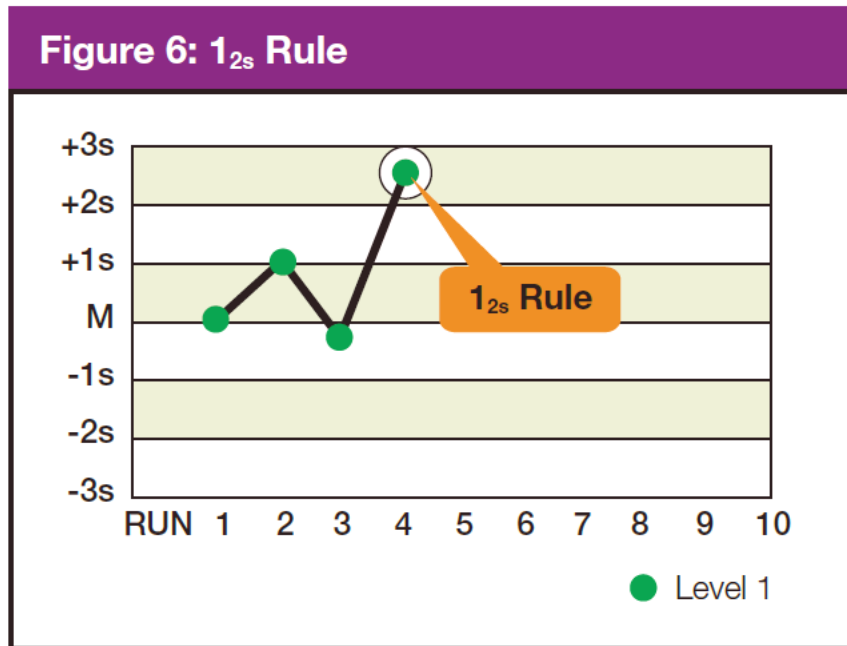

Exhibit 6-4. Westgard Rule 1_{3s}

Rule 1_{3s} . Identifies unacceptable random error or possibly the beginning of a large systematic error. Any QC outside $\pm 3S D$ violates this rule. A run is rejected when a single control measurement exceeds the mean ± 3 control limits.

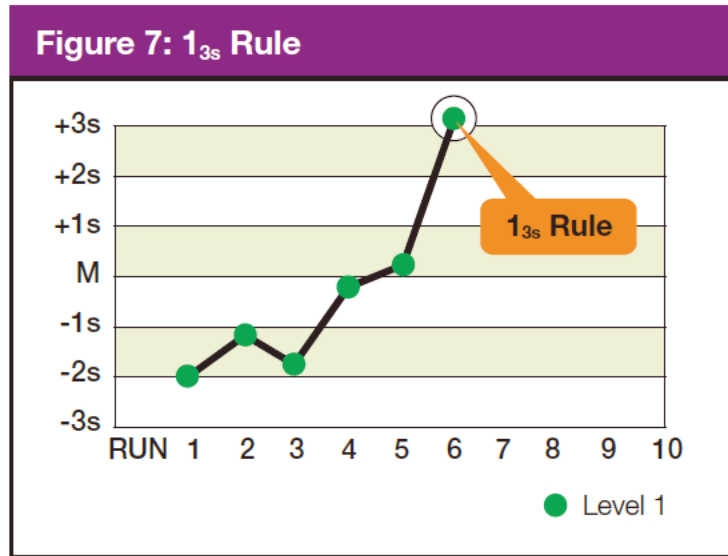

Exhibit 6-5. Westgard Rule 2_{2s}

Rule 2_{2s}. There are 2 rejection criteria for this rule: two consecutive QC results that are greater than 2SD that are on the same side of the mean. Violation within the run indicates that systematic error is present and that it potentially affects the entire analytical curve. Violation across the run indicates that only a single portion of the analytical curve is affected by the error. The control run is rejected with 2 consecutive control measurements are greater than 2 standard deviations of control limits on the same side of mean within or across the run, with this rule.

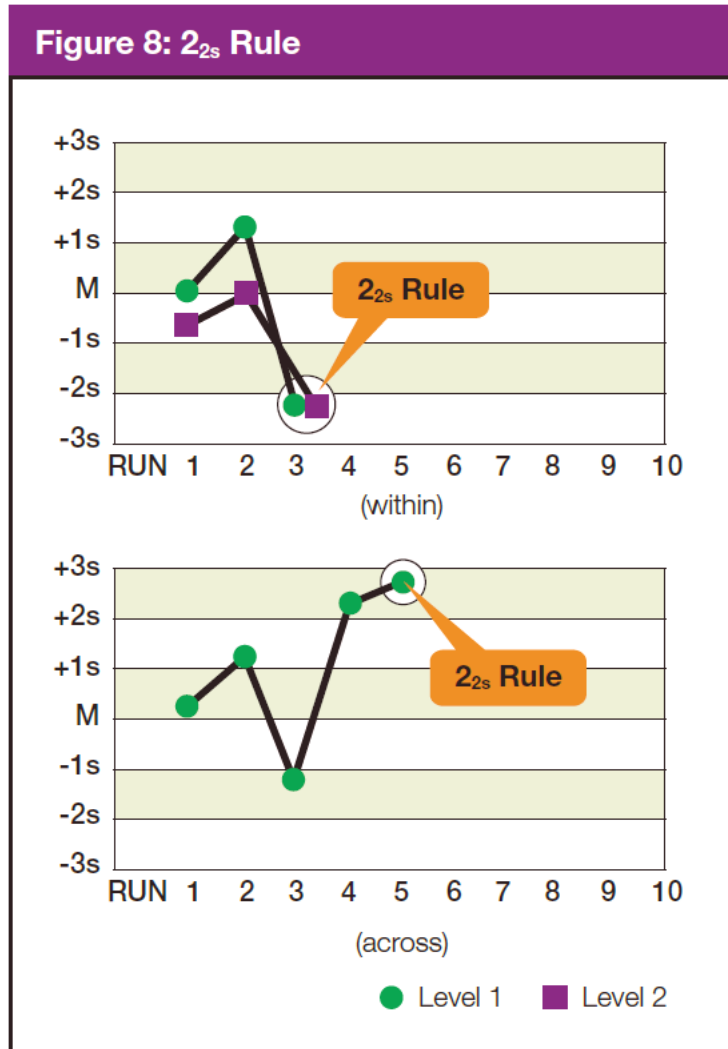
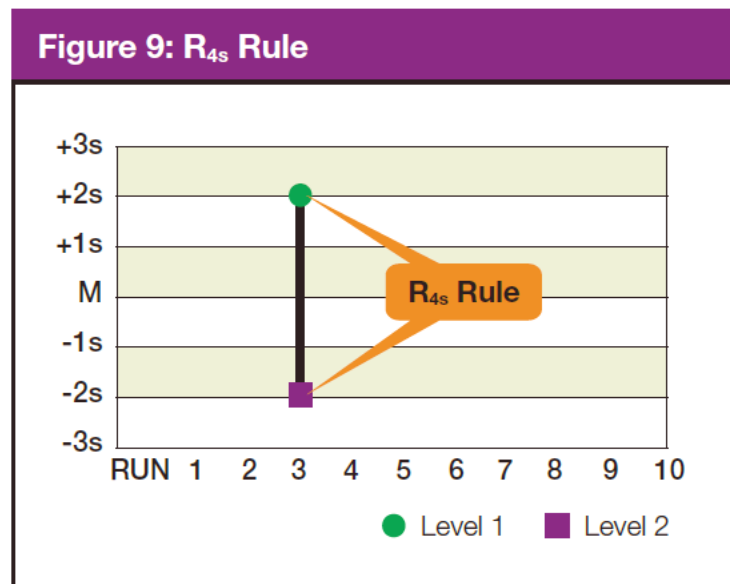

Exhibit 6-6. Westgard Rule_{4s}

Rule_{4s}. This rule rejects a run if there is at least a 4 SD difference between control values within a single run. For example, Level 1 control is + 2.9 SD above the mean and Level 2 is -1.4 SD below the mean. The total difference between the 2 control levels is greater than 4 SD. This rule identifies random error and is applied only within the current run.



NOTE: Violation of any of the following rules does not necessarily require rejection of the **analytical** run. These violations typically identify smaller systematic error or analytical bias that is not often clinically significant or relevant. Analytical bias may be eliminated by performing calibration or instrument maintenance.

Exhibit 6-7. Westgard Rule 4_{1s}

Rule 4_{1s} This rule is violated with the 4th consecutive control measurement exceeding 1 standard deviation on the same side of the mean. Troubleshooting action includes calling the Coulter hotline to see if other labs are reporting a bias with the same lot number of control. Perform any suggested diagnostic action or recalibrate if suggested by Coulter.

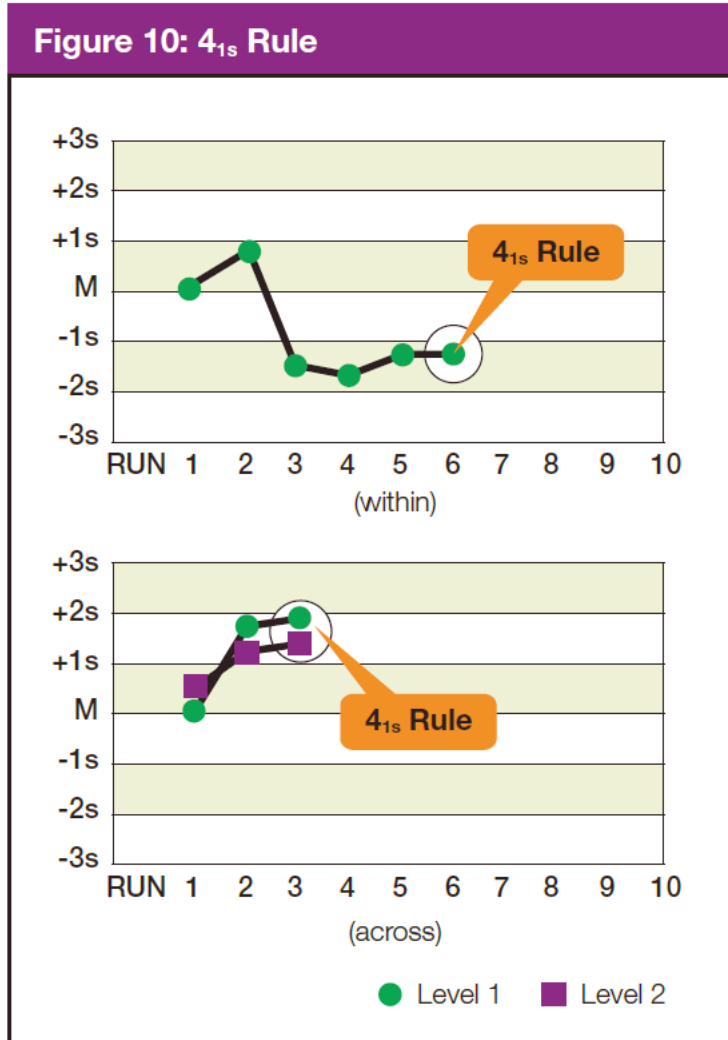



Table 6-2 lists the components seen on the QC Data View screen.

Table 6-2. Components on the QC Data View screen

Component	Description
Delta Diff	The difference between the calculated mean and the assigned target of the parameter within the specified filter. NOTE: If the Extended QC is enabled, and Extended QC limits have been configured, and the equation below is greater than (absolute Delta Diff/BCI Target Value) x 100, is greater than the Systematic Error limit, the Delta Diff will be highlighted in yellow for that parameter if N>=2 and N<15 or in red if N>=15. If the parameter's target is not applicable, N/A displays in this field.
Mean	The calculated mean of the included points within the specified filter.
25D	The calculated SD of the included points within the specified filter.
%CV	The calculated Coefficient of Variation of the included points within the specified filter. NOTE: If the Extended QC is enabled and Extended QC limits have been configured and the CV value is greater than the Random Error limit, the %CV will be highlighted in yellow for that parameter if N>=2 and N<15, or in red if N>=15.
RMSE	Root Mean Square Error (RMSE) displays when Extended QC is enabled. See Figure 4.2. The RMSE is a Single Measurement Error. If the value exceeds the Single Measurement Error limit, the RMSE value will be highlighted in yellow for that parameter if N>=2 and N<15. The value is highlighted in red if N>=15. If the parameter's target is not applicable, NA displays in this field.
N	The number of included points within the specified filter.
Target	The assigned target of the parameter being used in your lab at the time of the control analysis. The target used by Extended QC will be based on what has been configured for Traditional QC (either assigned or Mean to Target values).
(Assigned or Mean)	If Beckman Coulter or manually-entered targets are used, then the label below this heading reads "Assigned:" If means are used, then the label below the heading reads "Means." If the parameter's target is not applicable, N/A displays in this field.
Limit	The traditional expected limit of the parameter in use in your lab at the time of the control analysis.
(Manual, 2SD, or Lab)	If assigned limits are used, then the label below this heading reads "Manual." If SDs or Lab Limits are used, then the label below this heading reads "2SD" or "Lab," respectively.
Date/Time	The date and time of the control analysis.
Exclude	Allows you to exclude the results of that run from the control statistics calculations.
Reviewed By	Displays one of the following: <ul style="list-style-type: none"> ■ IF the run has not yet been reviewed: A Click to Review link that allows you to review the run. ■ If the run has been reviewed: The reviewer's user name and the review date and time.
Presentation	Displays the method of presentation for each run in the control file. <ul style="list-style-type: none"> ■ C = Cassette Presentation ■ S = Single-tube Presentation
Comment	A comment icon  displays in this column if any comments have been added.
Ref. RBC	If the control type is a RETIC only, a REF, RBC heading and numeric value display on the left side of the screen under the Summary Data columns. If the control is RETIC only and the Reference RBC Target and Limit are not set, No Value will display in the Ref. RBC field.

6.11.6 Selecting a Control

- From the Quality Control (Data View) screen or the Quality Control (Graph View) screen, select the Select Control button on the Local Navigation Bar to display the QC Select Controls dialog box.

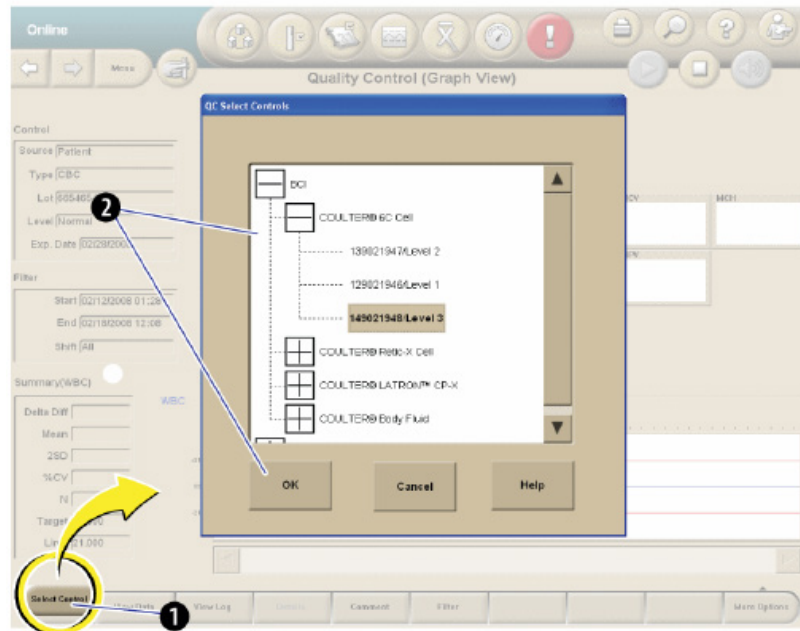

- Highlight the desired control and select OK.
- Exclude and rerun any control that is out of range. Document action taken to correct QC under comments on the Coulter screen in the affected control.

6.11.7 Viewing Control Files Graphically (Menu>QA>QC>View Graph)

From the Quality Control – Data View screen, select the View Graph button OR select a parameter (row) and double-tap the thumbnail Levey-Jennings graph.

The Quality Control (graph view) screen displays the following:

- Up to 31 thumbnail Levey-Jennings graphs, one graph per parameter.
- An expanded Levey-Jennings graph for the selected parameter data.
- Summary data for the selected parameter.

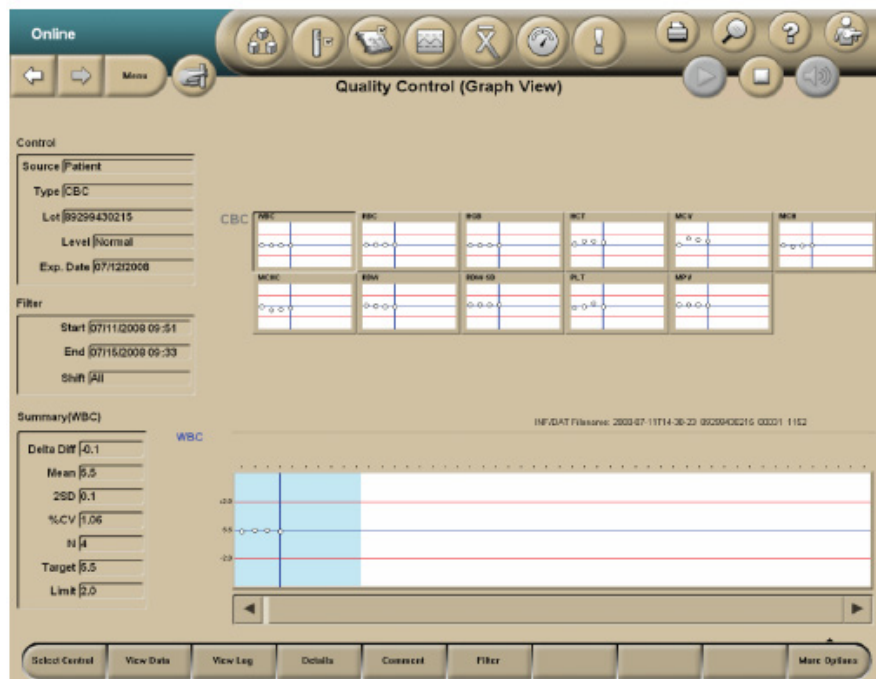

6.11.8 Using and Interpreting the Levey-Jennings Graphs

- The top half of the Quality Control (graph view) screen displays all parameters associated with controls.
 - Levey-Jennings graphs display the latest run points for all parameters.
 - Each graph displays up to 10 points, and these change to reflect the scrolling of the expanded graph.

- The points shown in the blue shaded window of the expanded graph reflect those shown in the thumbnail graphs.
- The point cursor on the thumbnail graphs is synchronized with the selected run within the data grid and the point cursor in the expanded graph.
- If you select a thumbnail graph, it will be displayed in the expanded graph section on the lower half of the screen.
- Any thumbnail graph's border displays red if it contains a QC Out point.
 - Once all runs in a graph are reviewed, its border will return to normal color, but the QC Out point will remain red in the graph.
 - If the results violate the extended QC Single Measurement Error, the point will be yellow.
- The expanded Levey-Jennings graph at the bottom of the Quality Control (graph view) screen displays all of the results for a selected parameter in the control file.
 - The blue-shaded window on the expanded graph, which contains up to 10 points and the point cursor, determines the points and cursor displayed in the thumbnail graphs.
- The point cursor is a blue vertical line on the graph that reflects the date selected in the Data View.
 - The cursor can be moved left or right by using the scroll bar or by selecting either the data points on the graph or the control run analysis Date/Times in the Data View table.
 - If the cursor moves to a point outside the window, the window shifts so that the new point displays in the window as the furthest right or left point.

6.11.9 Add, Modify, or Delete Comments to QC Results

- From the Quality Control (data view) or the Quality Control (graph view) screen, select the Comment button to display the QC Comment Dialog Box.

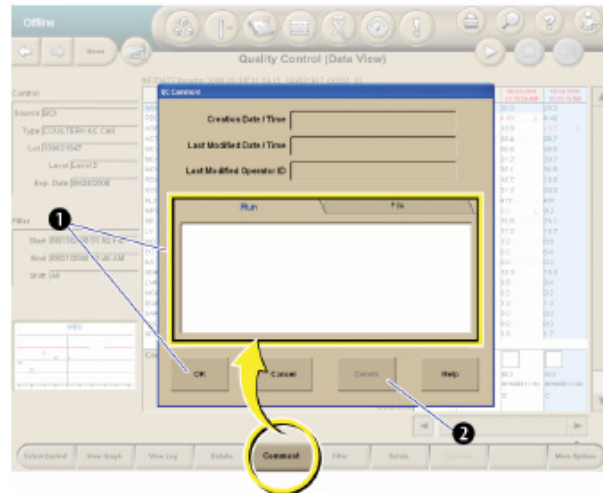

- The creation date/time, modified date/time, and last modified Operator ID will not be populated until the entry of the comment has been completed.
- To add or modify a comment on a control run, select the Run tab, type in the text box, and select OK.
- To add or modify a comment on a control file, select the File tab, type in the text box, and select OK.
- To delete a comment, select the Delete button.

6.11.10 View Control Files Under Error Conditions

- Under Error conditions, the Quality Control Status icon at the top of the screen is red.
- If more than one lot triggered an error condition, the Select Control File to Review dialog box displays.
- All lots that are OUT are displayed on the dialog box.
- To review a specific log, select the lot and select the OK button.

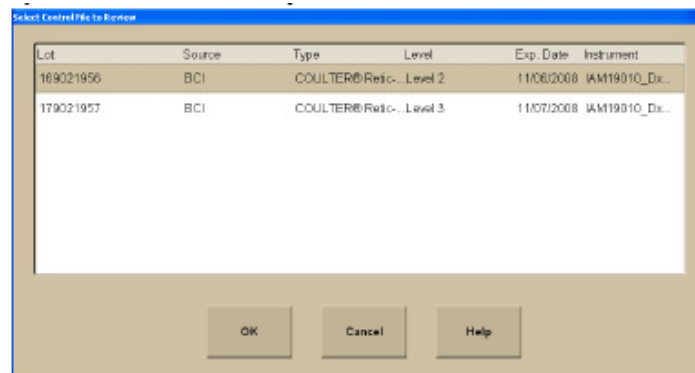

6.12 Sample Analysis

6.12.1 Status

- The SPM must be online to run samples.
- You can view the status of the SPM in the Status Mode area at the upper left corner of any screen, except the home screen.



6.12.2 Cassette Presentation

- Ensure that the SPM is set up for the appropriate test for your workflow.
- Ensure that your specimens have been collected and stored properly.
- Load the specimens into the cassettes. Narrow tubes with small internal diameters will require manual premixing prior to analysis to ensure proper cell and plasma distribution and to avoid possible erroneous results. Premix these tubes before placing them in the cassette and then analyze the cassette by placing it in the Stat position of the input buffer.
- Place the cassettes in the input buffer to the right of the SPM. The SPM automatically begins cycling the cassettes.
- After the SPM cycles the samples, review the sample results at the SM. To avoid serious injury, do not place your hand through the cassette presentation opening on the SPM.

6.12.3 Single-Tube Presentation

- Ensure that your specimens have been collected and stored properly.
- Select the Single-Tube Presentation icon  at the top of any screen to display the Single-Tube Presentation dialog box.

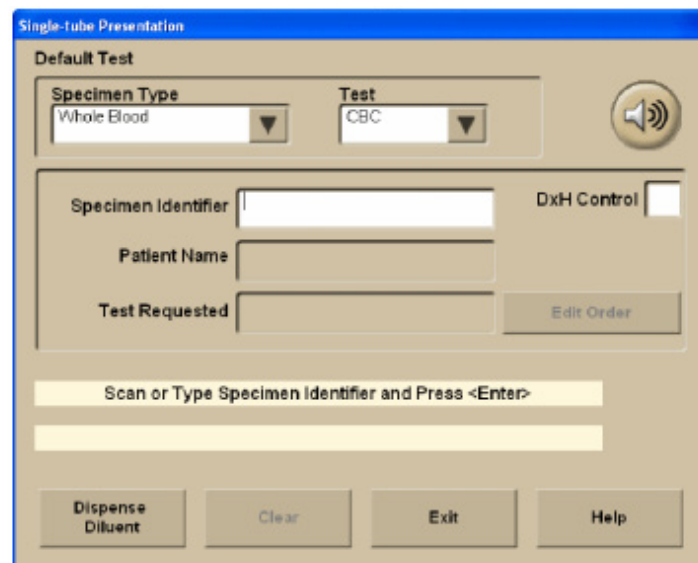

The image shows a software dialog box titled "Single-tube Presentation". It has a blue title bar and a tan background. At the top, under "Default Test", there are two dropdown menus: "Specimen Type" (set to "Whole Blood") and "Test" (set to "CBC"). To the right of these is a speaker icon. Below this is a section with three input fields: "Specimen Identifier" (with a white text box), "Patient Name" (with a white text box), and "Test Requested" (with a white text box). To the right of the "Specimen Identifier" field is a "DxH Control" checkbox. Below the input fields is a yellow bar with the text "Scan or Type Specimen Identifier and Press <Enter>". At the bottom of the dialog are four buttons: "Dispense Diluent", "Clear", "Exit", and "Help".

- Place the specimen on the bar code reader platform of the Single-Tube Presentation Station with the bar code facing the SPM to allow the Single-Tube Presentation bar-

code reader to scan the specimen label. The bar code may also be scanned with the handheld scanner or the Specimen Accession Number may be typed into the Specimen Identifier field.

- Verify the Specimen Accession Number and test request. Acknowledging the ID that displays on the SM screen indicates that you accept the either bar code label read or the manual entry.
- Thoroughly mix the specimen.
- Place the specimen in the correct single-tube position.
- Do not place a closed tube or a 16 mm-diameter tube in the right position of the single-tube presentation station. Doing so could cause incomplete aspiration and an erroneous result.

6.12.4 Handling Alarms

- An audible or visible alarm on the DxH 800 system should be addressed by reviewing the Event Logs on the History Log screen.
 - The Worklist-Custom tab can be used to select from predefined or user-defined filters to set the audible alarms.

6.13 Evaluation of Data

6.13.1 Flags

Flags appear to the right of the result:

- For some parameters, flagging occurs as a result of the flagging or editing of other parameters.
- Flags in the following exhibit are shown in order of placement on screens and printouts, with the highest priority flags at the top within each space.
- A yellow background on the screen indicates that results were above or below a reference range.
- A red background on the screen indicates that results exceeded an action or critical limit or that another flag was present.
- Flags appear in one of four positions to the right of the result.

- The flags are listed in order of priority within each space. It is possible to have flags in each of the four positions.
- Refer to Exhibit 6-8 to interpret DxH flags.

Exhibit 6-8. Interpretation of DxH flags

Flag and position				Description
1	2	3	4	
e				Result calculated from a manually edited parameter.
+				Result above the measuring range.
-				Result below the measuring range.
R				Review the result. Special handling is required for editing a result flagged with R. Any parameter derived from an R-flagged parameter cannot be recalculated until that parameter is edited. R flags may also indicate that a System Message has occurred. Check the message area on the patient result screen and the History Log > General table for details.
	c	L		Low critical limit exceeded.
	c	H		High critical limit exceeded.
	a	L		Low action limit exceeded.
	a	H		High action limit exceeded.
		H		High reference range limit exceeded.
		L		Low reference range limit exceeded.
			P	Partial aspiration detected during sample analysis.
			N	Non-blood sample detected.
			D	Delta check triggered.

6.13.2 Codes

Codes appear in place of results when the system cannot generate results:

- Codes are also called nonnumeric results.
- Codes in the following table are shown in order of the placement on screens and printouts, with the highest priority flags at the top within each space.

Refer to the following list to interpret DxH codes.

====	<p>Analysis was disabled at the configuration level of the SM (Menu > Setup > System > Analysis).</p> <p>For example: IF NRBC is temporarily disabled, any results with an NRBC enumeration in the panel will display ===== in place of the NRBC values. The ===== persists in the database after the analysis has been re-enabled.*</p>
xxxxx	<p>Although available on a panel, this parameter was not enabled as a Test (Menu > Setup > Reporting > Tests) at the time of analysis; however, after this analysis, the parameter was enabled as a test.</p> <p>For example: Sample A was analyzed for a CR panel, but the IRF and MRV were not enabled as Tests. Later, IRF and MRV were enabled as Tests; therefore, the system will not display the IRF and MRV parameters for CR panel results but, for Sample A, xxxxx displays in place of a value for those parameters.</p>
::::	Flow cell clog was detected.
-----	Total voteout occurred. No average histogram will appear for the affected parameter.
	<p>Incomplete computation. May occur in place of calculated parameters because a voteout or over-range occurred for a primary parameter used in the calculation. Occurs when the instrument cover is opened.*</p>
+++++	Result exceeds the operating range.
?????	Result is outside the range of values that can be formatted for display.
#####	Results were rejected.

6.13.3 Messages

Messages can be results-related or demographic- or status-related:

- Results-related messages:
 - Suspect messages (appear in red) are generated by internal algorithms to convey that a clinical condition may exist with a specimen based on an abnormal cell population or distribution.

Refer to the *Unicel DxH 800 Help Manual* on board the analyzer for a detailed list of all Suspect messages.
 - System messages (appear in green) indicate an event occurrence that may affect the operation of a system, requires operator notification, or entry into a History Log.

The majority of system messages are accompanied by an R (review) flag. Some are accompanied by N or P flags.

Refer to the *Unicel DxH 800 Help Manual* onboard the analyzer for a detailed list of all system messages.
 - Definitive messages (appear in blue) appear for results based on exceed limits configured as part of an individual flagging set.

Definitive messages can be created by copying reference ranges, or by manual entry of your own message definition.

Refer to definitive messages in the setup chapter of the onboard *Unicel DxH System Help Manual*.
- Demographic/status-related messages.
 - Exception Messages.
 - If there are any exceptions for a specimen, a comments indicator displays in the System Status Message area below the patient demographics.
 - Select the Additional Data button to view the Exceptions.
 - System Status Messages indicate that the instrument was operating in some nonstandard state when a specimen was analyzed. These states are usually the result of some user action. They do not indicate that any problem was seen when the specimen was analyzed; instead, they indicate that the system was being operated in a manner in which some problems might not be detected.
 - Lab Action Messages are triggered by Decision Rules programmed in the analyzer.

These messages are listed in the Lab Actions area of the Patient Results screen.

6.13.4 All Specimens

- Misleading results can occur if the specimen is not properly collected, stored, or transported. Beckman Coulter recommends that you follow CLSI or equivalent procedures to ensure proper specimen collection, storage, and transport. Always follow the manufacturer's recommendations when using micro-collection devices for capillary specimen collection.
- Misleading results can occur if specimens contain clots. Always use good laboratory practices for inspecting specimens for clots and verifying results.
- Misleading results can occur if the specimen is not properly mixed. Always use good laboratory practices to ensure that specimens are appropriately mixed. Do not bypass or circumvent the automated mixing process used on the DxH 800.
- When running a test panel, with NRBC analysis enabled, the information from the analysis is used to supplement interference detection, flagging, and correction.
- **WBC and TNC**
 - NRBCs, giant platelets, platelet clumps, malarial parasites, precipitated elevated proteins, cryoglobulin, microlymphoblasts, very small lymphocytes, fragmented white cells, agglutinated white cells, lyse resistant red cells, unlysed particles > 35 fl in size.
 - Elevated WBC counts may have a carryover effect on subsequent leukopenic specimens, within the limits specified by Beckman Coulter. (See the Carryover section in the *Unicel DxH Help Manual* on board the analyzer.)
- **RBC**
 - Very high WBC count, high concentration of very large platelets, auto-agglutination.
 - If hemolysis is occurring in vivo, the instrument RBC may be flagged as low, reflecting the true circulating cells. If, however, the hemolysis is in vitro, the specimen may give falsely low RBC results. Cell counts due to in vitro hemolysis do not represent the number of circulating red blood cells.
- **HGB**—severe lipemia, heparin, certain unusual RBC abnormalities that resist lysing.
- **MCV**—very high WBC count, high concentration of very large platelets, auto-agglutination.

- **RDW**—very high WBC count, high concentration of very large platelets, auto-agglutination.
- **PLT**—giant platelets, platelet clumps, white cell fragments, electronic noise, very small red cells, and red cell fragments.
- **HCT**—known interferences related to RBC and MCV.
- **MCH**—known interferences related to HGB and RBC.
- **MCHC**—known interferences related to HGB, RBC, and MCV.
- **NRBC**—known interferences may be related to the following:
 - Lyse-resistant red cells.
 - Malarial parasites.
 - Very small or multi-population lymphocytes.
 - Precipitated elevated proteins.
- **Differential**
 - Hypogranular granulocytes, agranular granulocytes, lyse resistant red cells, very small or multi-population lymphocytes, elevated triglycerides, precipitated elevated proteins.
 - A transient basophilia may be observed in samples that have been exposed to high temperatures (90° F or 32 °C). The temporary basophilia should resolve after stabilization at room temperature (72°F or 22° C).

6.14 Laser Safety

The Multi-Transducer Module contains a laser. A laser is a unique light source that exhibits characteristics different from conventional light sources.

The safe use of the laser depends upon familiarity with the instrument and the properties of coherent, intense beams of light. The beam can cause eye damage and instrument damage. There is enough power from the laser to ignite substances placed in the beam path, even at some distance. The beam might also cause damage if contacted indirectly from reflective surfaces (specular reflection). The laser on the DxH 800 is covered by a protective housing.

6.15 Calibration of the DxH 800

The S-CAL calibrator kit determines the adjustment factors for the calibration of the Coulter DxH 800. Calibration is a procedure to standardize the instrument by determining its deviation from calibration references and to apply any necessary correction factors. Calibration is performed in the closed-vial mode at ambient room temperature range (16-32°C, 60-90°F), using S-CAL as an alternative to whole blood.

6.15.1 Perform Calibration

- At the start of each stand, before you begin analyzing samples;
- After you replace any component dealing with dilution preparation, such as the BSV primary measurement, such as an aperture; and
- If your Beckman Coulter representative suggests that you calibrate.

6.15.2 Verify the Calibration of Your Instrument

- If controls show unusual trends or are outside limits; and
- When room temperature varies more than 10°F (5.5°C) from the room temperature during the last calibration.

6.15.3 Coulter Pre-Start-Up Procedure

Supply List: (1) Diluent; (1) Cell Lyse; (1) Diff Pak; (1) Cleaner; Latron; and 6C Cell Controls.

Arrangements for a Beckman Coulter representative to perform the necessary Pre-Start Up procedures on the DxH 800, prior to the arrival of the team to the stand, will be arranged by the Chief Field Medical Technologist in advance. These pre-start-up procedures for the representative will include:

- Removal of the travel brackets;
- Placement of all reagent lines in the reagents: Diluent, Cell Lyse, Diff Pak, and Cleaner (No RETICS!!!);

- Power up the analyzer;
- “*Wetting*” the analyzer (full prime of the system); and
- Flow cell adjustment.

A placard will be available for the representative (placed on the right side of the analyzer) with detailed instructions of the tasks that will need to be performed prior to the arrival of the team. The representative will be given the chief technologist’s number and email address in the event of any questions concerning the instructions.

6.15.4 Initial DxH 800 Startup

Perform a daily check after the instrument has been “Shutdown for at least 30 minutes.” Select Menu > QA > Daily Checks > Daily Checks > OK.

Draw three 4-ml EDTA tubes from a person with a normal CBC.

Inventory all Coulter reagents – mark with receive dates. (Once reagents have been opened, mark with an open date and tech initials).

- Log into the DxH SM

BEFORE DELETING THE PREVIOUS STAND’S DATABASE OR CONTROL FILES, VERIFY WITH THE CHIEF TECHNOLOGIST THAT IT IS OK TO PROCEED WITH THE FOLLOWING INSTRUCTIONS.

- **Delete the database from the previous stand** – Menu > Worklist > Custom > Advanced Search > Insert > Specimen > Analysis Date/Time > Between > Start Date/Time (*Enter MM/DD/YYYY & 24 HR hh:mm:ss that is at least 3 months prior to the current date*) and End Date/Time (*Enter MM/DD/YYYY & 24 HR hh:mm:ss that is 1 day before the current Setup date*) > Select OK > Select Save As (Create a Filter Name – Stand #: the stand you are getting ready to begin) > Search > Delete Order > Select All Test Orders in Current Filter > Select OK > Warning Box Will Appear, Select OK.
- **Delete previously used 6C Cell Control Files** – Menu > QA > QC > More Options > QC Setup > Select Previous (Older) Control File (will be highlighted) > Delete Control > OK.

You can only delete control files one at a time.

- **Enter reagent lot numbers and expiration dates** – Menu > Supplies > Setup > *Scan the Reagent Barcodes* > Select OK.
- **Enter 6C Cell Control lot numbers and expiration dates** – Menu > QA > QC > More Options > QC Setup > New Control from Barcode > Scan the 6C Cell Insert Barcode > Select ALL & Auto Transmit > Select OK.
- **Enter Latron Control lot numbers and expiration dates** – Menu > QA > QC > More Options > QC Setup > New Control from Barcode > Scan the Latron Insert Barcode > Select ALL & Auto Transmit > Select OK.
- **Double click the Coulter Icon on the desktop**, and verify that the icon is in the Task Bar (right-hand corner of the screen).
- **Enter 6C Cell and Latron Control Lot Information into ISIS** – Right-click on the Lab Coulter Icon in the Task Bar > Select Expected Values > Scan the Insert Barcode > Press Tab Key > Verify ALL Values > Select OK. Perform for both 6C Cell and Latron Control File Inserts.
- Place QC and Latron package inserts in the Coulter Binder.

Storage, handling, and stability: Sealed vials are stable through the expiration date when stored at 2–8° (35–46°F). S-Cal when opened is stable for 1 hour.

6.15.5 Repeatability, Carryover Check, and Calibration

Repeatability

Supply List: (2) 4-ml EDTA tubes filled with normal blood.

Before you can start or restart the Carryover process, the SPM must be **offline**.

Ensure that you have enough normal whole blood from a **single donor** for a minimum of 10 cycles, and delete any data on the Repeatability screen before starting a new study.

- Use (2) 4-ml EDTA tubes (aspiration probe damage can occur if a specimen tube is pierced more than five times).
- Select Menu > QA > Repeatability > Repeatability Setup:
 - Presentation: Cassette

- Test Panel: CD
 - Number of Aspirations: 5
 - Select OK and follow the screen prompts.
 - Place the two tubes in consecutive positions in a cassette, place the cassette in the input buffer, and Select OK on the DxH dialog box to start the cycle.
 - When the cycle has completed, review the results on the Repeatability screen. Use the scroll bar to review all the results. Verify the %CV and the Diff parameters (see limits below). Select Finish.
 - Verify that the coefficient of variation (CV) does not exceed the established Repeatability Limits:
 - **WBC** 2.5
 - **RBC** 2.0
 - **HGB** 1.5
 - **MCV** 2.0
 - **PLT** 5.0
 - **MPV** 3.0
 - Check the low to high difference (bottom line) for the **Diff** parameters with these Limits:
 - **NE%** ≤ 4.8
 - **LY%** ≤ 4.8
 - **MO%** ≤ 3.2
 - **EO%** ≤ 1.6
 - **BA%** ≤ 1.6
- If any of the results are outside the limits, call Beckman Coulter Customer Service.
- If all the results are within these parameters: Print > Select “Finish”, and proceed with Carryover Check.

Use the %CV line for CBC parameters only and the Diff line for the differential parameters only. Please see *Chapter 1: System Overview - Performance Specifications and Characteristics* section in the Help Menu for additional information regarding Repeatability limits for acceptability (Table 1.1 and Table 1.7).

6.15.6 Carryover

Supply List: One 4-ml EDTA tube filled with normal blood and three empty 4-ml EDTA tubes.

NOTE: Remove S-CAL from refrigerator to allow time to acclimate to room temperature. Before you can start or restart the Carryover process, the SPM must be offline.

- Fill three empty 4-ml Vacutainer® EDTA tubes with diluent. Select Single-Tube Presentation Icon > Dispense Diluent > Select OK. Place one empty capped EDTA tube in the purple tube holder on the left-hand side of the cradle. *1 ml of diluent is dispensed during this process.* Once completed, “Do you want to dispense more diluent in the same tube?” box will appear > Select No. Remove the filled EDTA tube, and repeat the above steps two more times to fill the 2 remaining empty EDTA tubes with diluent. Select Exit > “Are you sure you want to exit Single-tube Presentation?” > Select Yes.
- Select Menu > QA > Carryover > Carryover Setup:
 - Presentation: Cassette
 - Test Panel: CD
 - Select OK and follow the screen prompts.
- Select OK to start the Carryover procedure.
- Place a cassette in the input buffer with one blood tube followed by three diluent tubes consecutively and Select OK to start the Carryover procedure.
- When Carryover is complete, review the results on the Carryover screen. If any of the Carryover results “FAIL”, repeat the procedure.

If the Carryover results “FAIL” after the second attempt, call Beckman Coulter Customer Service.

- If the status of all parameters is “PASS”: Print.

When performing a Carryover procedure, the calculated percent Carryover and/or Background for each parameter is compared to the Carryover and Background limits for acceptability. Please see

Chapter 1: System Overview - Performance Specifications and Characteristics section in the Help Menu for additional information regarding Carryover and Background limits for acceptability (Table 1.12 and Table 1.13).

6.15.7 Calibration

Supply List: (1) S-CAL Calibrator.

NOTE: Before you can start or restart the Calibration procedure, the SPM must be offline.

- Allow S-CAL to warm to ambient (room) temperature for approximately 15 minutes.
- Select Menu > QA > CBC Calibration > Calibration Setup. You will be prompted by a dialog box which states: Existing Data will be deleted. Select OK to continue.
 - Number of Aspirations: 11.
 - Presentation: Cassette.
 - Calibrator Type: BCI.
- Select Upload > *Scan the S-Cal Insert Barcode* > Verify ALL Values > Select OK.
- Mix the S-CAL by hand by rolling the tube slowly between the palms of the hands eight times in an upright position. Invert the tube and slowly roll it again eight times. Gently invert the tube eight times. Repeat these actions. When all cells are uniformly distributed, place the calibrator in the cassette.
- Place the cassette in the input buffer and Select OK to start Calibration Procedure.
- Exclude the first run by checking the box beside that run.
- Review the Calibration results.
- If all the results are within the specified parameters: Print > Select Finish.
- If results recommend Calibration (the boxes at the bottom of the calibration screen are check marked) > Select OK.

The background of the Factor %Diff, %CV, and Difference cells changes color when the presented value is out of the normal range as follows:

- Yellow for Difference indicates that the value is out of range, which means that calibration is recommended.
- Red applies only to the %CV and indicates that the statistical value is NOT within range and the system does NOT allow calibration.

When all results are acceptable, the Edit System Recommendations button at the bottom right corner of the screen is enabled. This button allows the modification of the calibration recommended by the system by selecting or deselecting check boxes. Please see **Chapter 1: Chapter 1** section in the Help Menu for additional information regarding Calibration limits for acceptability.

- Verify the Calibration by running controls. Menu > QA > QC > Select Control > *Select the Control that you want to view* > Select OK] Select “Reviewed By” to review controls > Print.

NOTE: Place all printed charts and control inserts into the DxH Logbook, and have all results verified by a Beckman Coulter Representative via a VIP Service Call or an email. Have a copy of the VIP Service Report sent to the chief technologist’s Westat email.

This is the NHANES Coulter Monitor icon. It must be open and running at the start of each session. This icon stores all DxH 800 runs in the ISIS database. Double-click on the Coulter icon, so it displays in the lower right task bar. Once the icon is displayed, the Coulter and the ISIS Laboratory application are communicating with each other.



6.16 Run Study Participants

Exhibit 6-9 presents a picture of blood tubes.

Exhibit 6-9. Picture of tubes



- Place tube in the cassette and place in the SPM.
- Run all samples in duplicate. The DxH is now set to automatically rerun SP samples in duplicate, but not controls.

To set DxH 800 for automatic repeat of each SP sample, use the following sequence of steps:

Menu> Set-up>Flagging/Rules>Rules> Select decision rule workbench tab (upper right)>Add Rules>Rule name: “Type “Repeat” at the *> Specimen Type: use drop-down menu and select whole blood>Rule description: “Type automatic repeat if condition $RBC < 10$ ”> Additional test: Check Rerun box in additional test box>OK. Place analyzer offline>Activate Decision Rules Tab(middle center tab) > Activate Rule (lower left)

- Run samples in the primary mode.

Check to make sure the printer is working properly. Operate the analyzer with the doors and panels closed. Monitor reagent levels.

6.16.1 Review Data and Transmit

- Review the data. Menu>Patient Results.
- Data from the Coulter DxH 800 are automatically transmitted to the ISIS system when the NHANES Coulter monitor icon has been opened on the ISIS screen.
- Use the Worklist screen to sort, retrieve, transmit, and archive data to CD. Transmit data from the Coulter® DxH 800 to ISIS as necessary. Save all data to CD at the end of each stand.

6.16.2 Daily Shutdown

See Section 6.8, pages 6-13 to 6-15.

6.16.3 Prolonged Shutdown

- If the instrument is going to be idle for >72 hours, as in summer or winter 2-week breaks, adjust the shutdown procedure as follows: Menu>QA>Daily Checks>AutoConfiguration>Configure Shutdown> Uncheck Daily, Check only boxes for every other day (Mon, Wed, Fri, Sun)> OK. Ensure that there is sufficient cleaner and diluent for shut-downs during the break time.

6.16.4 Beginning and End of Stand Operations

- Beginning of stand:
 - Arrange for a Coulter service representative to remove all travel brackets and re-wet the system.
 - Follow procedure for Calibration, Repeatability, and Carryover Check.
- End of stand.

NOTE: Call Coulter Support to have an engineer install the travel brackets and perform the travel shutdown procedure for the DxH 800.+ **Before the engineer performs this service,** the following tasks must be completed by the technologist assigned to the Coulter for that stand:

6.16.5 Transmit All Current Stand QC data into ISIS

- Select (QC Icon) > Select Control > Select 6C Cell Control Level 1 > Transmit > Select All Runs in Current Control File > Select OK. The Coulter Icon on the workstation computer will “flicker” to indicate the transmission of data. Once the flickering has stopped, repeat the same steps beginning with Select Control and transmit QC data for 6C Cell Control Levels 2 & 3, followed by the Latron Control File.

6.16.6 Print ALL 6C Cell Control and Latron Files

- Select [QC Icon] > Select Control > Select 6C Cell Control Level 1 > Select [Printer Icon] > Change Report Type to Summary Report > Select [*Control Lot*] and check mark all Current Stand Controls (Both Latron and 6C Cell Files) > Select [*Print*] All Runs > Select [*Print Options*] Data Report and Graphical Report > Select Thumbnails > Select Print.
- Clip all the reports together with a binder clip and place them in Renee’s End of Stand FedEx Box.

6.16.7 Export DxH 800 Data to Three (3) Discs

- DISC 1: IQAP
 - **Export IQAP Data. Insert a blank disc into the disc drive.** Select Menu > Set up > Quality Control > IQAP Export > All DxH Control Lots > Multiple Shifts > CD Recorder > Start > Follow screen prompts.

*Label the disk **IQAP** and include **Stand # and MEC #** and place the disc in Renee’s End of Stand FedEx Box.*

- DISC 2: LOGS
 - **Export Log Data. Insert a blank disc into the disc drive.** Select Menu > Logs > Export > Select ALL in (1) Event, (2) Data Summary, (3) Maintenance, and (4) Audit Logs > Select and Enter Date Range (Start of Stand to End of Stand) > Select Start. The disc will automatically eject out of the disc drive upon completion.

*Label the disk **Logs** and include **Stand # and MEC #** and place the disc in Renee’s End of Stand FedEx Box.*

- DISC 3: DATABASE
 - **Export Patient Log (Database). Insert a blank disc into the drive.** Select Menu > Worklist > Custom > Advanced Search > Filter Name (Stand #) > Insert > Specimen > Analysis Date/Time > Between (Start of Stand to End of Stand) > OK > Search > Export > Type CSV > All Results in Current Filter > Destination CD Recorder (G:\) > **Select Start.** The disc will automatically eject out of the disc drive upon completion.

*Label the disk **Database** and include **Stand # and MEC #** and place the disc in Renee's End of Stand FedEx Box.*

6.16.8 Perform Cleaning Procedures on the DxH 800 and Assimilate Paperwork for Shipment to Home Office

- Clean the aspiration probe. Select Menu > Maintenance > Clean Aspiration Probe > [Start]. Once Procedure has Completed Select Finish > [OK].
- Clean the BSV, the Handheld Barcode Scanner, and the STM and wipe the analyzer's exterior with lint-free tissue and deionized water.
 - Complete the Hematology Maintenance Log and include all of the paperwork from the Hematology Notebook, including the following: Daily Check Logs, Package Inserts, Precision Checks, and Calibration Data. This information should be binder-clipped separately into the respective subsections and included in the End of Stand FedEx Box to the Laboratory Component Specialist at Westat. The box can now be sealed and sent with the rest of the shipment.

Service performed by a Beckman-Coulter Representative

- Discard all trash and empty reagent boxes after the representative has finished decommissioning the analyzer.
- Strap down and secure the DxH and computer monitor for the impending travel.

6.17 Coulter Reportable Range of Results

Table 6-3 presents the Coulter reportable range of results.

Table 6-3. Coulter reportable range of results

Parameter	Linearity	Limits: The greater of
WBC x 10 ³ cells/ μ l	0 to 99.9	0.2 or 3.0%
RBC x 10 ⁶ cells/ μ l	0 to 7.00	0.05 or 2.0%
Hgb g/d	0 to 25.0	0.2 or 3.0%
MCV fL	50.0 to 150.0	2.0 or 3.0%
Plt x 10 ³ cells/ μ	0 to 999	10.0 or 7.0%
MPV fL	5.0 to 20.0	5.0%

6.18 Integrated Survey Information System

6.18.1 Record 6C Cell and Latron® Lot Numbers in Integrated Survey Information System

The Computerization: The Integrated Survey Information System (ISIS) maintains the capability to download all 6C cell and Latron® control data. The data are used to monitor quality control results. Upload or enter data for each lot number each time a new lot number is put into use. The ISIS uses the same 6C cell control package insert and Latron package insert as the DxH 800.

- Access the Coulter QC Lot Info module.
- Right-click on Coulter icon in the bottom right corner of window.

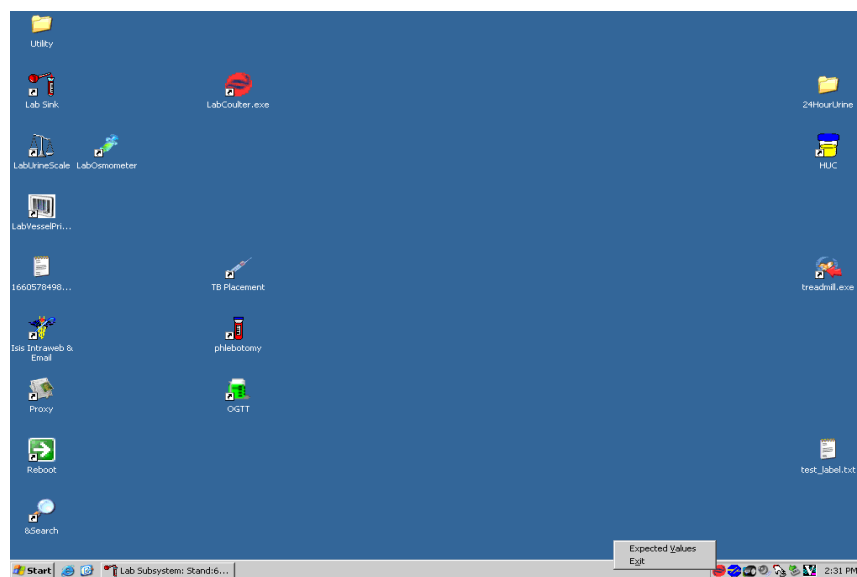

- Click on Expected Values to bring up the Coulter QC Input Screen for 6C cell controls and Latron QC.

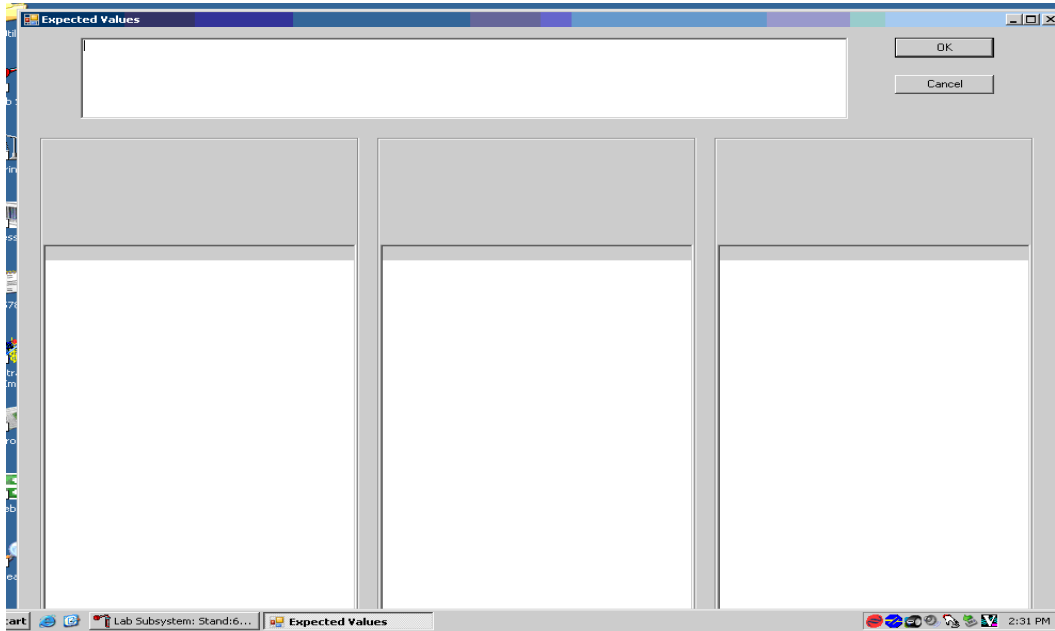

- Make sure cursor is in the top window, scan the bar code on the Coulter Package insert, and wait until data fill in the top window.

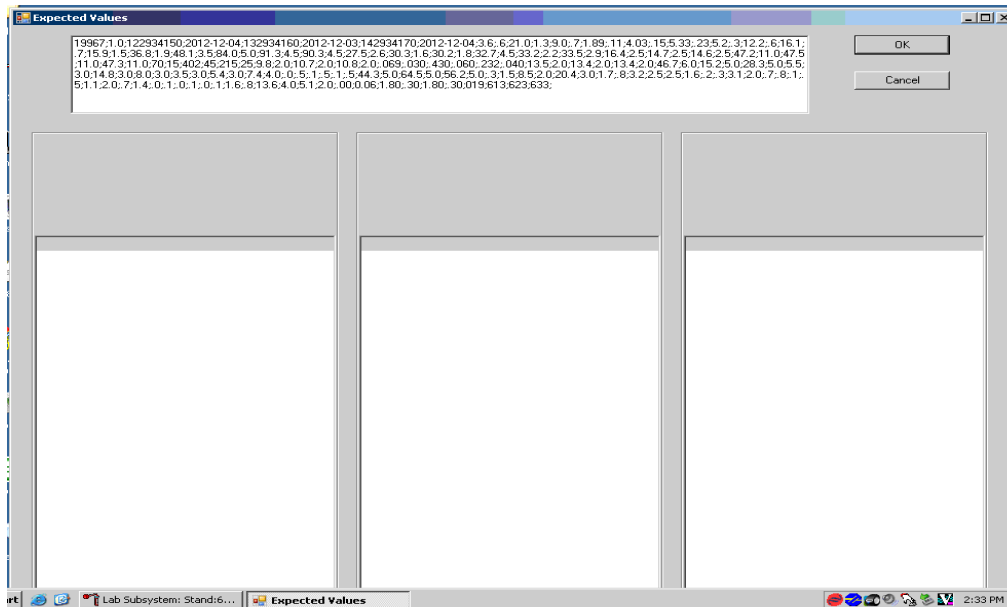

- Tab to populate the bottom windows for each level of 6C cell control.

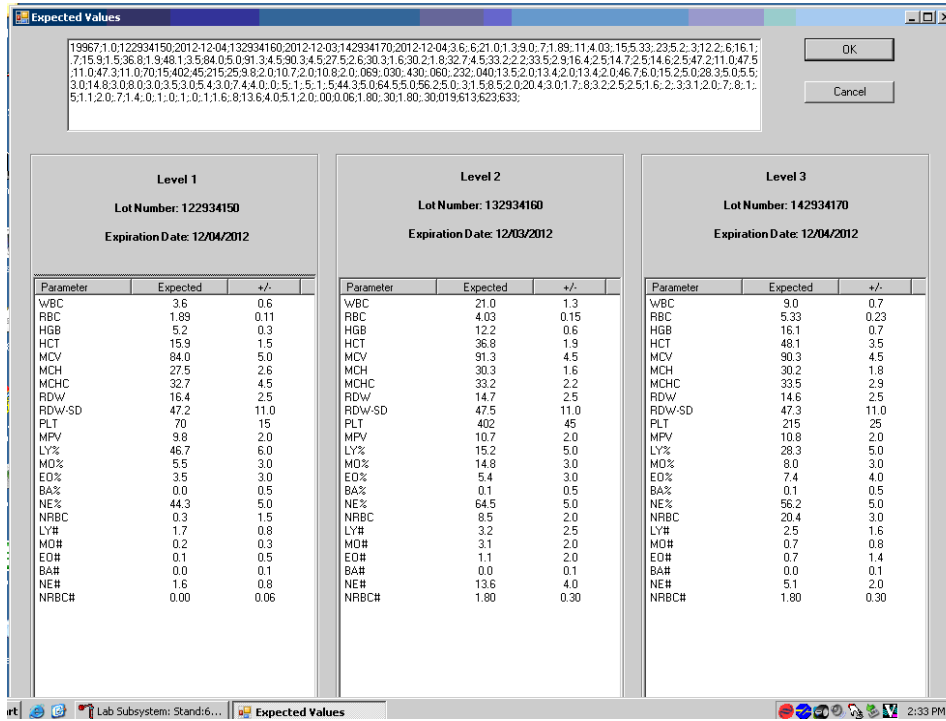

- Screenshot depicting Latron QC expected values for Diff, Retic, and NRBC.

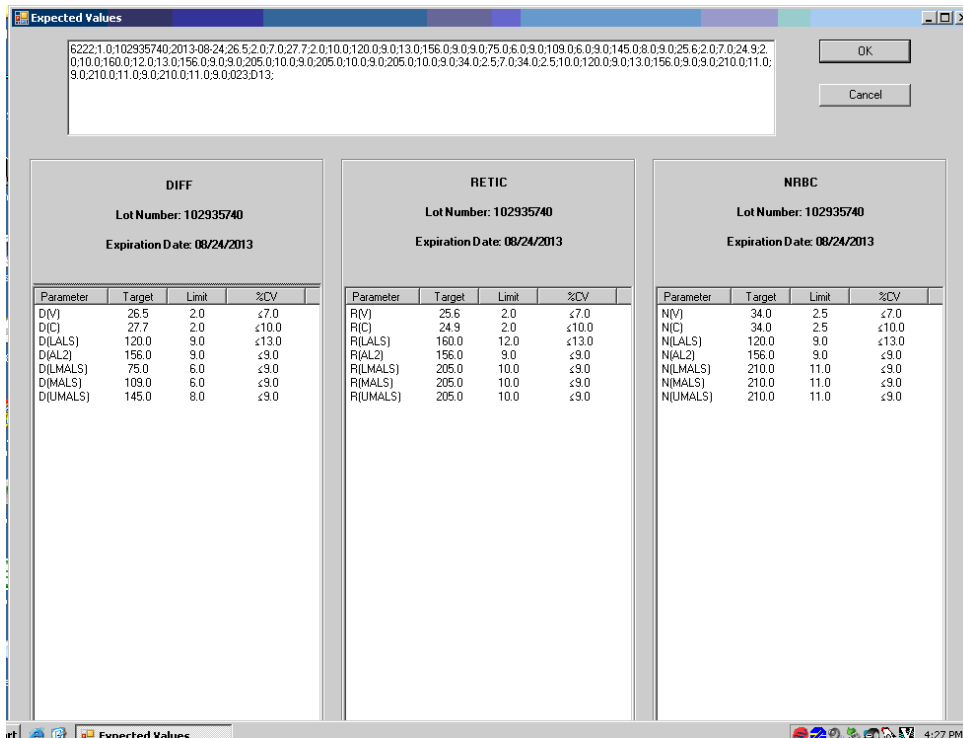

- Check the expected values against the package insert and click OK to save and exit.

6.18.2 Interlaboratory Quality Assurance Program (IQAP)

All instruments participate in Coulter's IQAP program. The IQAP program includes saving results of 6C cell controls, transferring them to a CD, and sending them to Coulter who compares the results to other laboratories. Coulter issues a report that contains a statistical analysis to evaluate performance. Perform this procedure at the end of each stand.

The procedure to download IQAP files to CD follows:

- Slide the CD into the drive and gently close CD holder.
- Menu > QA > QC > More options (bottom of screen) > Export.
- Type: CVS.
- Data Selection: All runs in current control file.
- Folder: CD Recorder Radio Button.

Repeat for each of the three levels of QC.

6.18.2.1 Reviewing IQAP Peer Group Means (Chief Techs)..

- Use the website - <https://qapweb.beckmancoulter.com/qapweb/>.
- Login.
- Choose the Analyzer (with note that B1 is MEC 3, B2 is MEC 2, B3 is MEC 1).
- Review active pool statistics.
- Put in lot number of 1st level 6C.
- View report.
- **NOTE:** Look at Mean and SD (not the assayed value) which is what is on the assay sheet we get. The Mean and SD are the averages for all the labs submitting data for this lot using 800 DXH. The shown SD is 2 SD from the peer mean.
- BACK.
- Use same procedure for remaining lot #.

6.18.3 Proficiency Testing

Evaluation and participation in the College of American Pathologist (CAP) proficiency-testing program is part of the comprehensive quality control program. These survey materials are shipped three times per year and consist of five 3-ml whole blood specimens. Follow all CAP instruction in preparing the materials before performing the test. Run specimens in a manner identical to routine specimens. Fill out the CAP result form, make a copy for the logbook, and send results to CAP.

After the assigned primary medical technologist has tested and recorded results, other medical technologists are to perform the testing and record their results without consultation with primary tech. The secondary techs' results will be sent to the Laboratory Manager as a record of competency testing.

To make barcode labels:

- Utility on Desktop;
- “Dymo test labels”; and
- Highlight the label shown:
 - Click on “Properties” in far upper right
 - Symbology – choose “code 128 Auto”.
 - Data: Barcode delete “Click me” or “0000001” and type in proficiency sample number, i.e. FH6-01
 - Align: Center
 - Size: Medium
 - Show Barcode Text: Below
- Print: will print on dymo labelmaker
- Repeat for all 5 samples;
- Exit out; and
- “No” to “do you want to save?”

To auto print results for proficiency samples:

- Menu> Set Up> Reporting> Auto Report
- box “print Lab Report as Each Analysis is Complete”
- Back out of setup
- BE SURE to uncheck box after you have finished running and printing samples

Run Proficiency samples in cassette (will be run twice under current setup and each result will print separately).

- Average results on NHANES Hematology CAP Results worksheet;
- Computer> MECSTAFF>Lab;
- Save as KitName-KitNumber_YYYY-MMDD_MEC#_Tech Initials_ P (for primary) or S (for secondary operator);
- Enter results on CAP paperwork; and
- Enter results in CAP site on computer using your own personal CAP login:
 - Log in to the CAP site with individual account info.
 - Click on the e-lab solutions suite.
 - On the right side of the screen, click on the Request access to laboratory data link.
 - The screen will open that will ask you to enter the CAP number.
 - Enter – 6910001.

Have another tech proof your computer entry before final send. Take a picture of your worksheet as a copy of your work, print for your records. Place your worksheet with indication of kit number, primary or secondary operator, your name and date in the Heme logbook to forward to Component Manager at end of stand and also email the primary copy to component manager. Record on your annual CAP survey Check Sheet. Indicate if you were primary or secondary operator

6.18.4 Linearity for WBC, RBC, Hgb, and Plt Parameters

Lin-X™ (PN 628029) – The Lin-X™ linearity control verifies the reportable range of Coulter® hematology system parameters for WBC, RBC, Hgb and Plt.

OR

CAP Hematology Calibration Verification/Linearity Survey (LN9) - These materials are shipped once per year and consist of 18 3-ml liquid specimens. Follow all CAP instruction in preparing and running the materials before performing the test. Fill out the CAP result form, make a copy for the logbook, and send results to the Laboratory Manager at the end of the stand.

Run either the Lin-X™ or CAP LN9 survey material:

- At installation;
- At least yearly; and
- Whenever experiencing an altitude change of 1 mile or more between stands.

Principle – Lin-X™ linearity controls are human blood components from which repeated measurements verify the reportable range of Coulter hematology systems. Controls contain 12 vials, ranging from 0-12. Lin-X™ verifies the ranges for the following parameters: WBC, RBC, Hgb, and Plt.

To ensure the accuracy of linearity control ranges, Coulter system calibrates with S-CAL calibrator.

6.19 Interpretation of Results and Remedial Action

6.19.1 Sample Person Hemoglobin and Hematocrit Review and Remedial Actions

Review all results to make sure the hemoglobin and hematocrit are acceptable. The hematocrit should be approximately three times the hemoglobin. If an “H&H Does Not Match Flag” pops up on both runs of an SP, repeat run using the EDTA sample from processing, if available, as a check. Report out results if all runs are similarly flagged. Delete all but two of the runs before averaging.

6.19.2 SP Parameter Value Review and Remedial Actions

1. Access the Hematology module or reject a clotted blood tube.

Open the Hematology module.

The Hematology module does not need to be open before running SP samples on the DxH 800. Note the red icon in the lower right corner of the system tray.



This is the NHANES Coulter Monitor icon. It must be open and running at the start of each session. This icon stores all DxH 800 runs in the ISIS database. Double-click on the Coulter icon on the desktop to open the application.



Open the Hematology module: direct the mouse arrow to Modules, in the top menu bar, left-click, drag the mouse arrow to Hematology, and right-click.

SP ID	Sample ID	Status	Type	Gender	Age	Name	Process Status							
							UC	U	P	CB	B	PC	F	M
329869	329869	SC	P	F	12	HOWARD, CHARLES S	○	○	○	○	○	○	-	-
386827	386827	SC	P	F	26	DEEGAN, DOUG O	○	○	○	○	○	○	○	-
416714	416714	SC	P	F	16	BAILEY, ANTHONY J	○	○	○	○	○	○	○	-
499508	499508	SC	P	F	5	DEEGAN, MARK	○	○	-	○	○	-	-	-
525757	525757	SC	P	M	3	LAST NAME, PAT M	○	○	-	○	○	-	-	-
745052	745052	SC	P	F	12	TIM, SP FIRST NAME M	○	○	○	○	○	-	-	-
767995	767995	SC	P	F	39	NAME, LAST M	○	○	○	○	○	-	○	-
836040	836040	SC	P	M	54	TORRES, LUCAS T	○	○	-	○	○	-	-	○
849425	849425	SC	P	F	16	CAMPBELL, VINNIE N	○	○	○	○	○	○	○	-
919919	919919	SC	P	M	57	PAYNE, IMA L	○	○	-	○	○	○	-	○

Alternatively, open the Hematology module from the heads-up display.

The screenshot shows the Lab Sink software interface. The main window displays a table of patient samples with columns for SP ID, Sample ID, Status, Type, Gender, Age, Name, Process Status, and HPV. A context menu is open over the first row, showing options like Urine Processing, Blood Processing, and Hematology. The Hematology option is selected, and a sub-menu is open showing Process CBC Data, Not Processed CBC Data, and Review CBC Results.

SP ID	Sample ID	Status	Type	Gender	Age	Name	Process Status			HPV			
							UC	U	P	CB	B	PC	F
329869	329869	SC	P	F	12	HOWARD, CHARLES S							
386827	386827	SC	P	F	26	DEEGAN, DOUG O							
416714	416714	SC	P	F	16	BAILEY, ANTHONY J							
499508	499508	SC	P	F	5	DEEGAN, MARK							
525757	525757	SC	P	M	3	LAST NAME, PAT M							
745052	745052	SC	P	F	12	TIM, SP FIRST NAME M							
767995	767995	SC	P	F	39	NAME, LAST M							
836040	836040	SC	P	M	54	TORRES, LUCAS T							
849425	849425	SC	P	F	16	CAMPBELL, VINNIE N							
919919	919919	SC	P	M	57	PAYNE, IMA L							

To access the Hematology module, direct the mouse arrow to any SP, right-click, drag the mouse arrow to Hematology then to Process CBC Data, and right-click. Alternatively, use the arrow keys to move up and down the list until a particular SP is highlighted, right-click, drag the mouse arrow to Hematology then to Process CBC Data, and right-click.

Either open the module or reject the specimen and add a reason or comment for every CB record where blood was drawn in phlebotomy AND there are no CBC results.

SP ID	Sample ID	Status	Type	Gender	Age	Name	Process Status						HPV	
							UC	U	P	CB	B	PC	F	M
329869	329869	SC	P	F	12	HOWARD, CH	<input type="radio"/>	<input type="radio"/>	<input type="radio"/>	<input type="radio"/>	<input type="radio"/>	<input type="radio"/>	-	-
386827	386827	SC	P	F	26	DEEGAN, DO	<input type="radio"/>	<input type="radio"/>	<input type="radio"/>	<input type="radio"/>	<input type="radio"/>	<input type="radio"/>	<input type="radio"/>	<input type="radio"/>
416714	416714	SC	P	F	16	BAILEY, ANTH	<input type="radio"/>	<input type="radio"/>	<input type="radio"/>	<input type="radio"/>	<input type="radio"/>	<input type="radio"/>	<input type="radio"/>	<input type="radio"/>
499508	499508	SC	P	F	5	DEEGAN, MA	<input type="radio"/>	<input type="radio"/>	<input type="radio"/>	<input type="radio"/>	<input type="radio"/>	<input type="radio"/>	<input type="radio"/>	<input type="radio"/>
525757	525757	SC	P	M	3	LAST NAME,	<input type="radio"/>	<input type="radio"/>	<input type="radio"/>	<input type="radio"/>	<input type="radio"/>	<input type="radio"/>	<input type="radio"/>	<input type="radio"/>
745052	745052	SC	P	F	12	TIM, SP FIRS	<input type="radio"/>	<input type="radio"/>	<input type="radio"/>	<input type="radio"/>	<input type="radio"/>	<input type="radio"/>	<input type="radio"/>	<input type="radio"/>
767995	767995	SC	P	F	39	NAME, LAST	<input type="radio"/>	<input type="radio"/>	<input type="radio"/>	<input type="radio"/>	<input type="radio"/>	<input type="radio"/>	<input type="radio"/>	<input type="radio"/>
836040	836040	SC	P	M	54	TORRES, LUCAS T	<input type="radio"/>	<input type="radio"/>	<input type="radio"/>	<input type="radio"/>	<input type="radio"/>	<input type="radio"/>	<input type="radio"/>	<input type="radio"/>
849425	849425	SC	P	F	16	CAMPBELL, VINNIE N	<input type="radio"/>	<input type="radio"/>	<input type="radio"/>	<input type="radio"/>	<input type="radio"/>	<input type="radio"/>	<input type="radio"/>	<input type="radio"/>
919919	919919	SC	P	M	57	PAYNE, IMA L	<input type="radio"/>	<input type="radio"/>	<input type="radio"/>	<input type="radio"/>	<input type="radio"/>	<input type="radio"/>	<input type="radio"/>	<input type="radio"/>

Open the module (Process CBC Data) or record a reason why the CBC is not being run (Not Processed CBC Data). Select or record a comment for every CBC that is not run. To complete opening or accessing the Hematology module, direct the mouse arrow to Process CBC Data and right-click. To record a reason why a CBC is not being run, direct the mouse arrow to the exact SP's line on the heads-up display, right-click, drag the mouse arrow to Not Processed CBC Data, and drag the mouse arrow to the correct reason and right-click.

A pop-up window will display. Confirm the selection.

SP ID	Sample ID	Status	Type	Gender	Age	Name	Process Status						HPV	
							UC	U	P	CB	B	PC	F	M
329869	329869	SC	P	F	12	HOWARD, CHARLES S	<input type="radio"/>	<input type="radio"/>	<input type="radio"/>	<input type="radio"/>	<input type="radio"/>	<input type="radio"/>	-	-
386827	386827	SC	P	F	26	DEEGAN, DOUG O	<input type="radio"/>	<input type="radio"/>	<input type="radio"/>	<input type="radio"/>	<input type="radio"/>	<input type="radio"/>	<input type="radio"/>	<input type="radio"/>
416714	416714	SC	P	F	16	BAILEY, ANTHONY J	<input type="radio"/>	<input type="radio"/>	<input type="radio"/>	<input type="radio"/>	<input type="radio"/>	<input type="radio"/>	<input type="radio"/>	<input type="radio"/>
499508	499508	SC	P	F	5	DEEGAN, MA	<input type="radio"/>	<input type="radio"/>	<input type="radio"/>	<input type="radio"/>	<input type="radio"/>	<input type="radio"/>	<input type="radio"/>	<input type="radio"/>
525757	525757	SC	P	M	3	LAST NAME,	<input type="radio"/>	<input type="radio"/>	<input type="radio"/>	<input type="radio"/>	<input type="radio"/>	<input type="radio"/>	<input type="radio"/>	<input type="radio"/>
745052	745052	SC	P	F	12	TIM, SP FIRS	<input type="radio"/>	<input type="radio"/>	<input type="radio"/>	<input type="radio"/>	<input type="radio"/>	<input type="radio"/>	<input type="radio"/>	<input type="radio"/>
767995	767995	SC	P	F	39	NAME, LAST	<input type="radio"/>	<input type="radio"/>	<input type="radio"/>	<input type="radio"/>	<input type="radio"/>	<input type="radio"/>	<input type="radio"/>	<input type="radio"/>
836040	836040	SC	P	M	54	TORRES, LUCAS T	<input type="radio"/>	<input type="radio"/>	<input type="radio"/>	<input type="radio"/>	<input type="radio"/>	<input type="radio"/>	<input type="radio"/>	<input type="radio"/>
849425	849425	SC	P	F	16	CAMPBELL, VINNIE N	<input type="radio"/>	<input type="radio"/>	<input type="radio"/>	<input type="radio"/>	<input type="radio"/>	<input type="radio"/>	<input type="radio"/>	<input type="radio"/>
919919	919919	SC	P	M	57	PAYNE, IMA L	<input type="radio"/>	<input type="radio"/>	<input type="radio"/>	<input type="radio"/>	<input type="radio"/>	<input type="radio"/>	<input type="radio"/>	<input type="radio"/>

A CBC Data Not Processed message text box displays that asks, “Would you like to mark sample id XXXXXX as Clotted/Not Enough Blood/Equipment Failure/Lab Error?” To record a “Yes” response, direct the mouse arrow to the Yes button and left-click, type [Y], or press Enter. To record a “No” response, direct the mouse arrow to the No button and left-click, or type [N]. If a “Yes” response is recorded, the comment is saved to the database. If a “No” response is recorded, no comment is saved to the database. If the record is marked with the selection in the database, then the heads-up display updates to complete (the CB circle fills in black).

2. Hematology module overview

The CBC results are not automatically populated in the Hematology module. Use the Retrieve button to send the results from ISIS to the Hematology module. Select after each run. Make sure the Coulter DMS host computer icon (HC) is displaying an up arrow (↑) in the DMS bottom tile bar.

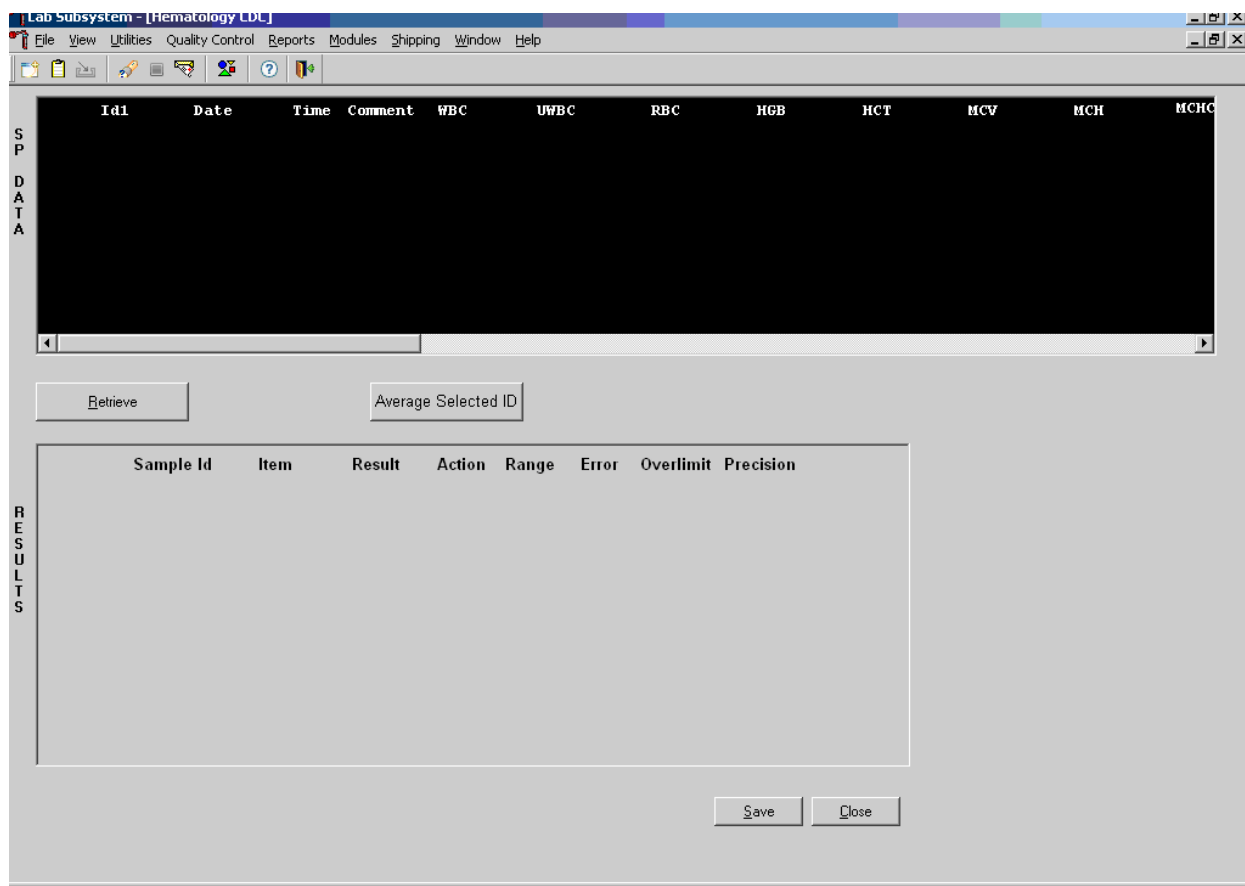

After data are retrieved, they display in the top portion of the window, the SP Data section. This section includes the SP ID, the date and time the CBC was run, and columns for each parameter.

The bottom portion of the window is the Results section. Results display after the Average Selected ID button is selected.

Review all Coulter data in the SP Data section after they are retrieved.

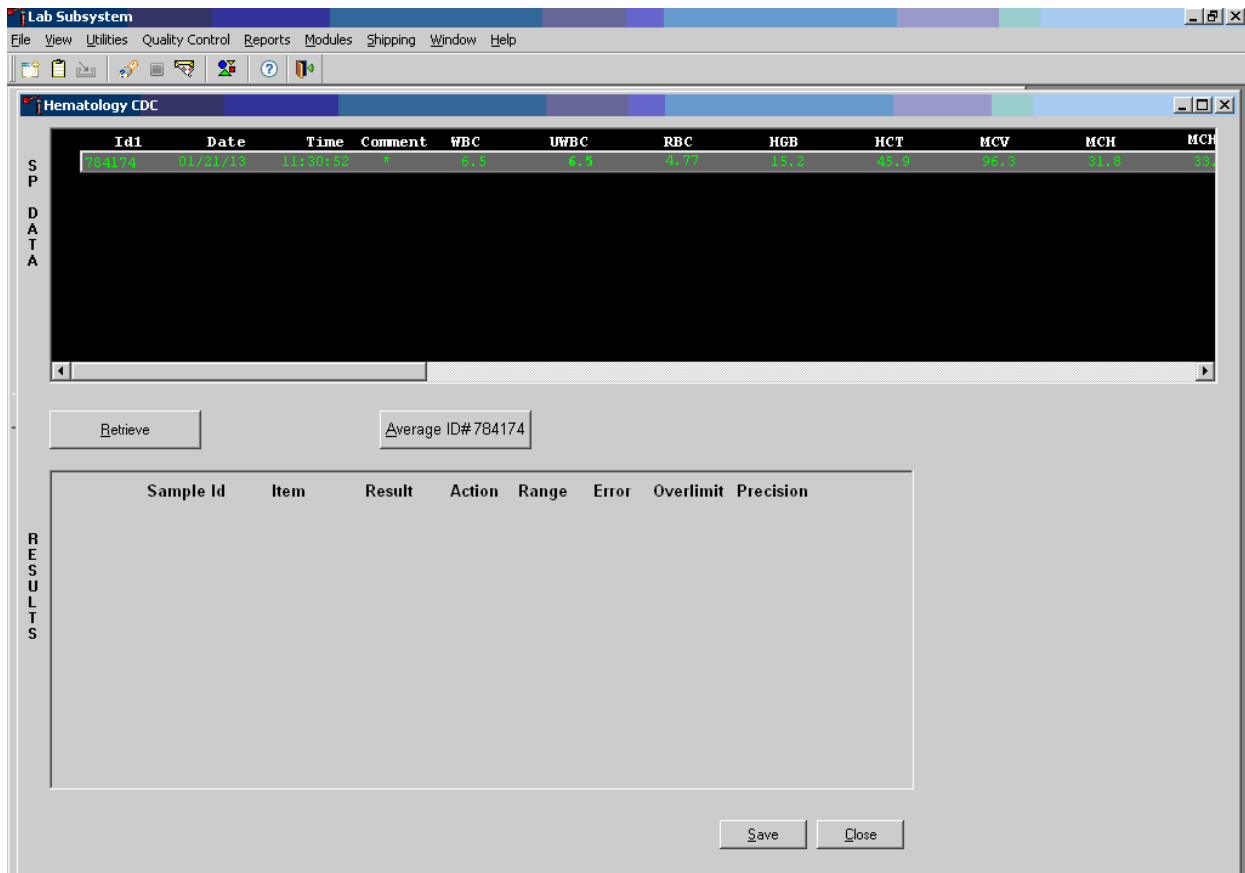

To view SP data for all parameters, direct the mouse arrow to the horizontal scroll bar at the bottom of the SP Data section and drag the scroll bar to the left or right. Alternatively, to view the SP data for all parameters, direct the mouse arrow to the small scroll arrows on the left and right edges of the horizontal scroll bar, and left-click.

Hematology Results section overview. The Result columns include: Sample ID, Item (CBC parameter), Result (Coulter data for a single run or the ISIS-averaged result for multiple runs), Action (CDC-established critical limits), Range (CDC-established reference ranges for both genders and four age groups), Error (Coulter-transmitted instrument errors), Overlimit (Coulter-transmitted result that exceeds the instrument's linearity limit), and Precision (CDC-established values for the difference between any two runs). Checkmarks display in boxes for parameters that have errors, are

over limit, or for those that exceed precision limits. An “H” for “high” and “L” for “low” display for parameters that exceed action limits or reference ranges.

Average, evaluate, and save results for all parameters. The SP’s results display in the bottom portion of the window after the Average Selected ID button is selected. To view results for all parameters, direct the mouse arrow to the vertical scroll bar at the right side of the Results section and drag the bar up or down. Alternatively, to view all the results, direct the mouse arrow to the small scroll arrows on the top and bottom edges of the vertical scroll bar, and left-click. Evaluate each parameter for error, overlimit, and precision check marks, and “H” or “L” action limit and reference range flags. To save the result to the database, direct the mouse arrow to the Save button and left-click. After results are saved, they are erased from the screen. To exit without saving the result to the database, direct the mouse arrow to the Cancel button and left-click.

A warning text box displays if the Close button is selected before the results have been saved.

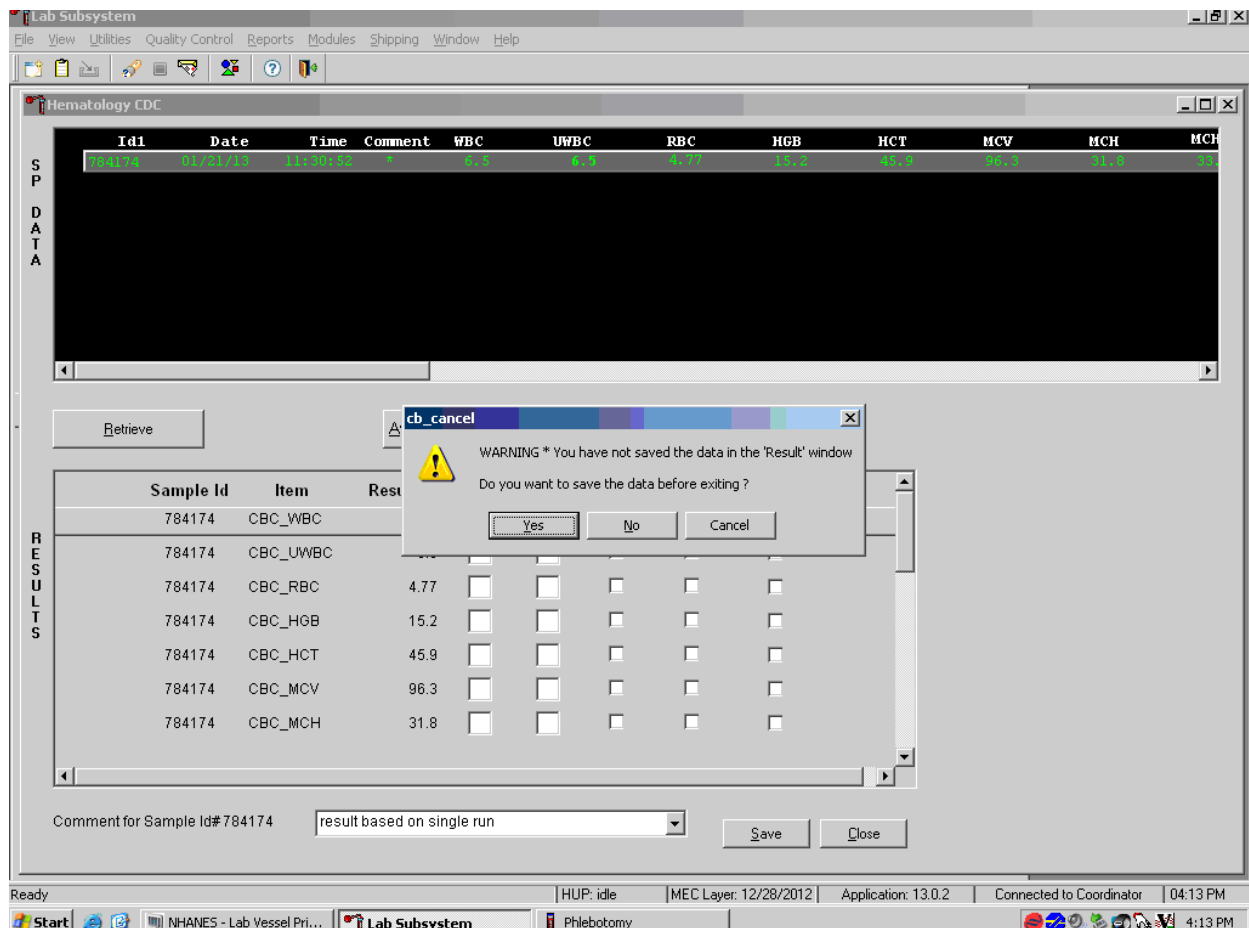

If the Close button is selected before the results are saved to the database, a warning message text box displays that states, “WARNING * You have not saved the data in the ‘Result’ window” and asks, “Do you want to save the data before exiting?” To record a “Yes” response, direct the mouse arrow to the Yes button and left-click, type [Y], or press Enter. To record a “No” response, direct the mouse arrow to the No button and left-click, or type [N]. To cancel the action, direct the mouse arrow to the Cancel button and left-click. If a “Yes” response is recorded, the CBC results are saved to the database and erased. If a “No” response is recorded, no results are saved to the database and the data in the Results section are erased. A Cancel response returns the screen to its previous state.

3. Running samples when only one run is possible

Save results where only one run was possible.

The screenshot displays the Lab Subsystem - [Hematology CDC] interface. The main window is titled "Lab Subsystem - [Hematology CDC]" and has a menu bar with "File", "View", "Utilities", "Quality Control", "Reports", "Modules", "Shipping", "Window", and "Help". Below the menu bar is a toolbar with various icons. The main area is divided into two sections: "S P D A T A" (top) and "R E S U L T S" (bottom). The "S P D A T A" section contains a table with columns: Id1, Date, Time, Comment, WBC, UWBC, RBC, HGB, HCT, MCV, MCH, and MCHC. The "R E S U L T S" section contains a table with columns: Sample Id, Item, and Result. A "Retrieve" button is located above the "R E S U L T S" table. A "Average" dropdown menu is set to "Average ID# 745052". A warning dialog box is open, titled "of_get_rowcount", with a yellow warning icon. The dialog box text reads: "WARNING: You have downloaded only one (1) run from the Coulter for SPID 745052. Do you want to create an average based on a single run?". There are "Yes" and "No" buttons in the dialog box. At the bottom of the main window, there are "Save" and "Close" buttons. The status bar at the bottom of the window shows: "ready | HUP: idle | MEC Layer: 12/28/2012 | Application: 13.0.2 | Connected to Coordinator | 11:52 AM".

Run samples in duplicate whenever possible. If the whole blood is insufficient, it is acceptable to average and save only one run. To save results where only one run is possible, direct the mouse arrow to the Average Selected ID box and left-click. A warning message text box displays that states, “You have downloaded only one (1) run from the Coulter for SPID XXXXXXX” and asks, “Do you want to create an average based on a single run?” To record a “Yes” response, direct the mouse arrow to the Yes button and left-click or type [Y/y]. To record a “No” response, direct the mouse arrow to the No button and left-click, or type [N/n], or press Enter. If a “Yes” response is recorded, the CBC results display in the bottom Results section of the window. A “No” response cancels the action and returns the window to its previous state.

For results where only one run was possible, the Comment box at the bottom of the window defaults to “result based on single run.”

4. Running samples in duplicate

Run all samples in duplicate and average the data.

The screenshot displays the Hematology CDC window in the Lab Subsystem. The main table shows the following data:

SPID	Id1	Date	Time	Comment	WBC	UWBC	RBC	HGB	HCT	MCV	MCH	MCHC
329869	01/20/13	15:07:41	*	5.3	5.3	4.98	11.1	35.6	71.5	22.3	31.1	
329869	01/20/13	15:10:19	*	5.3	5.3	4.99	11.1	35.7	71.4	22.2	31.1	
416714	01/20/13	15:07:41	*	5.3	5.3	4.98	11.1	35.6	71.5	22.3	31.1	
416714	01/20/13	15:10:19	*	5.3	5.3	4.99	9.1	35.7	71.4	22.2	31.1	

Below the table, there are buttons for 'Retrieve' and 'Average ID# 416714'. The Results section contains a table with the following header:

Sample Id	Item	Result	Action	Range	Error	Overlimit	Precision
-----------	------	--------	--------	-------	-------	-----------	-----------

The status bar at the bottom of the window displays: Ready | HUP: idle | MEC Layer: 12/28/2012 | Application: 13.0.2 | Connected to Coordinator | 04:30 PM

Whenever a sample is run in duplicate, both results display in the SP Data section. To average these two results, direct the mouse arrow to Average ID#XXXXXX button and left-click. Results display in the lower section of the window.

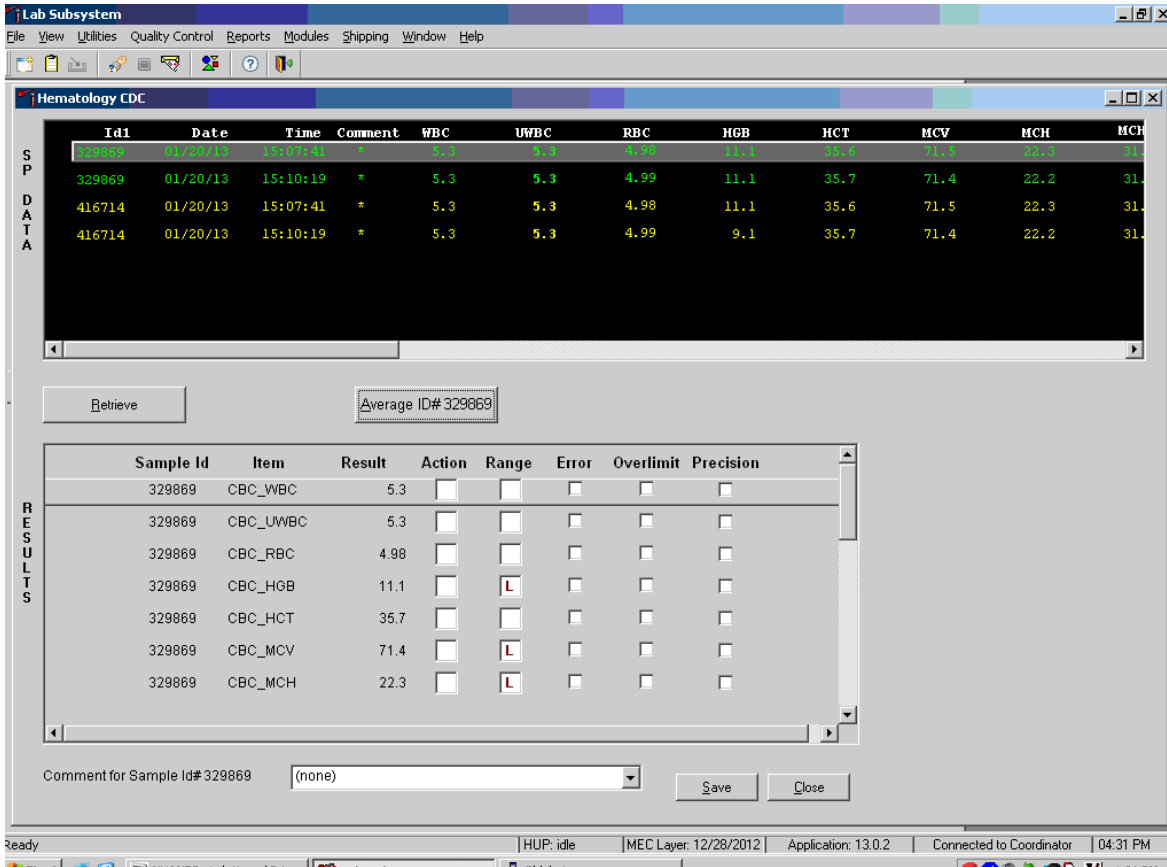

The differences between duplicate values for WBC, RBC, Hgb, MCV, Plt, NE#, LY#, MO#, EO# and BA# are calculated and evaluated to determine if they are within the following CDC established precision limits (Table 6-4).

Table 6-4. CDC precision limits

Test	Precision limits
WBC	$\pm 0.4 \times 10^3$
RBC	$\pm 0.1 \times 10^6$
Hgb	± 0.4 g/dl
MCV	± 2.2 fL
Plt	$\pm 23 \times 10^3$
NE#	$\pm 0.4 \times 10^3$
LY#	$\pm 0.2 \times 10^3$
MO#	$\pm 0.2 \times 10^3$
EO#	$\pm 0.2 \times 10^3$
BA#	$\pm 0.2 \times 10^3$

If RBC parameters are out of range, evaluate the data for drift. If drift is evident, evaluate the possibility of an instrument malfunction. If any WBC differential absolute number is out of range, check the WBC scattergram for abnormal cell population(s). Evaluate and save results when precision limits are not exceeded.

The screenshot shows the Lab Subsystem Hematology CDC interface. The top window displays a table of sample data with columns: Id1, Date, Time, Comment, WBC, UWBC, RBC, HGB, HCT, MCV, MCH, and MCHC. Below this is a 'Retrieve' button and a text field containing 'Average ID# 329869'. The bottom window displays a 'RESULTS' table with columns: Sample Id, Item, Result, Action, Range, Error, Overlimit, and Precision. The table contains data for sample 329869 across various CBC parameters. At the bottom, there is a 'Comment for Sample Id# 329869' dropdown menu set to '(none)', and 'Save' and 'Close' buttons.

Id1	Date	Time	Comment	WBC	UWBC	RBC	HGB	HCT	MCV	MCH	MCHC
329869	01/20/13	15:07:41	*	5.3	5.3	4.98	11.1	35.7	71.4	22.3	31.1
329869	01/20/13	15:10:19	*	5.3	5.3	4.99	11.1	35.7	71.4	22.2	31.1
416714	01/20/13	15:07:41	*	5.3	5.3	4.98	11.1	35.6	71.5	22.3	31.1
416714	01/20/13	15:10:19	*	5.3	5.3	4.99	9.1	35.7	71.4	22.2	31.1

Sample Id	Item	Result	Action	Range	Error	Overlimit	Precision
329869	CBC_WBC	5.3					
329869	CBC_UWBC	5.3					
329869	CBC_RBC	4.98					
329869	CBC_HGB	11.1	L				
329869	CBC_HCT	35.7					
329869	CBC_MCV	71.4	L				
329869	CBC_MCH	22.3	L				

Evaluate results for all parameters. Evaluate each parameter for error, overlimit, and precision check marks, and “H” or “L” action limit and reference range flags. If there are no check marks in the Precision column (no precision limit was exceeded), save the results to the database. To save the results to the database, direct the mouse arrow to the Save button and left-click. After results are saved, they are erased from the screen. To exit without saving the result to the database, direct the mouse arrow to the Close button and left-click.

Average, evaluate, and rerun specimens that exceed precision limits.

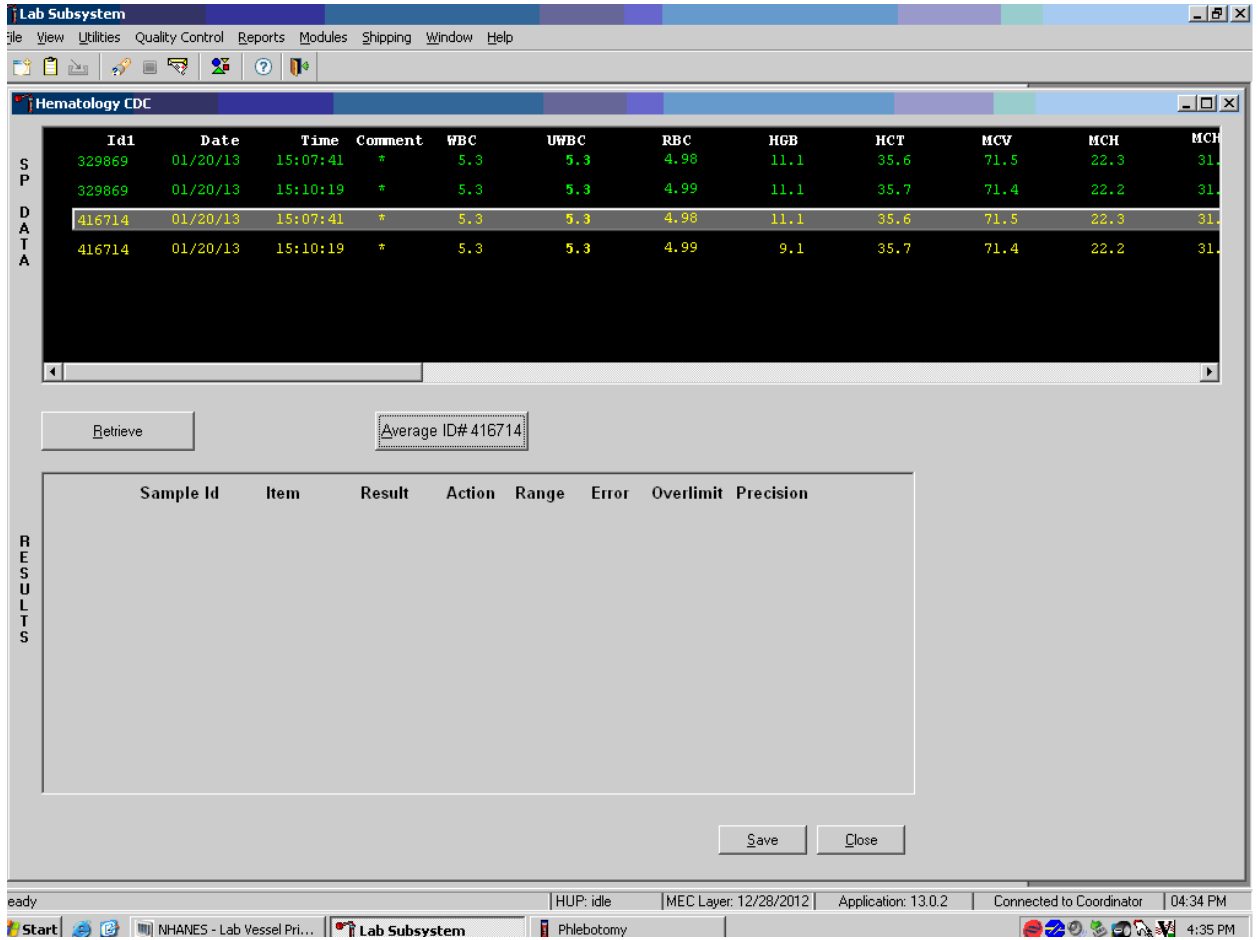

Average the two results by using the mouse to direct the mouse arrow to the Average ID#XXXXXX button and left-click. If, at this point, precision limits are exceeded for any individual parameter, the technologist is prompted to run a control and to evaluate it to determine if all control values fall within the control’s established range.

If any parameter exceeds its precision limit, the Hematology Control Run window displays.

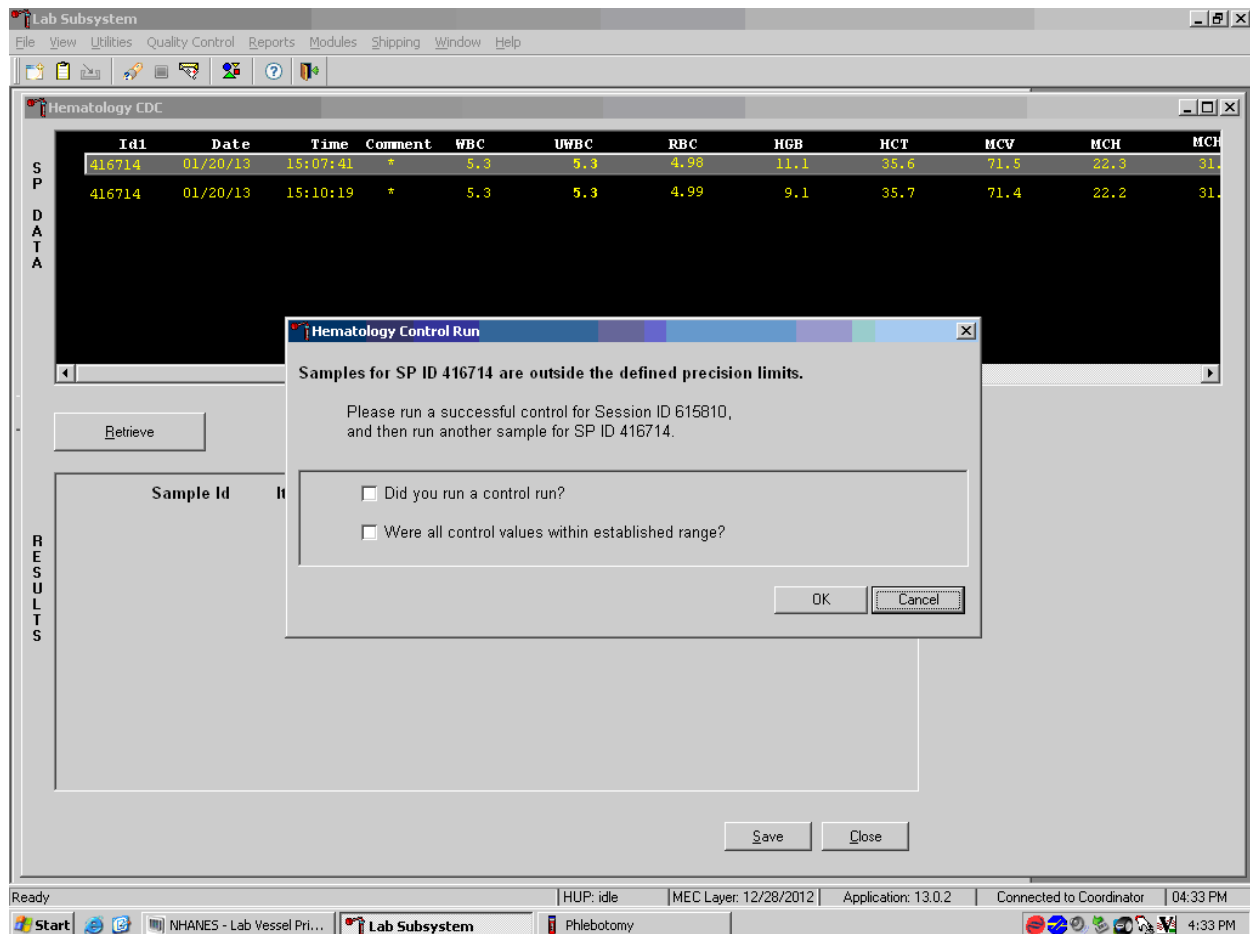

The Hematology Control Run window indicates that the “Samples for SP ID XXXXXX are outside the defined precision limits.” It instructs the technologist to “Please run a successful control for Session ID XXXXXX, and then run another sample for SP ID XXXXXX.” If it has been >30 minutes since running the sessions QC (all three levels of 6C Cell control), run any one level of 6C cell control and evaluate the results. Respond to the two questions, “Did you run a control run?” and “Were all control values within established range?” To confirm these actions, direct the mouse arrow to each of the two check boxes and left-click to record the check marks.

Save the responses to the check box questions.

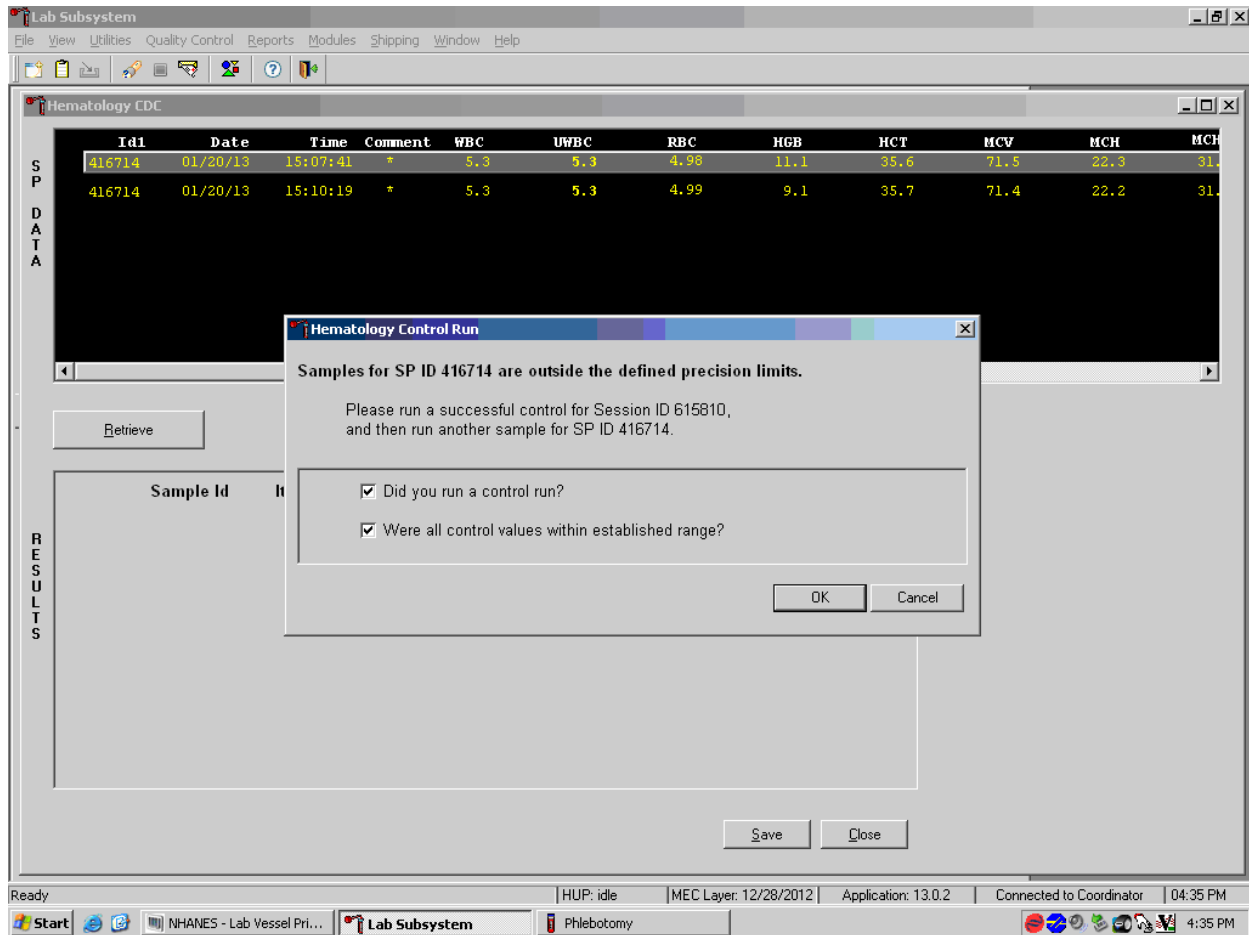

To save these responses to the database, direct the mouse arrow to the OK button and left-click or type Enter. To exit the Hematology Control Run window without saving the responses, direct the mouse arrow to the Cancel button and left-click. As soon as the OK button is selected, the averages display in the Results section of the window.

Evaluate the results displayed in the Results section of the window.

The screenshot shows the Lab Subsystem interface. The main window is titled "Hematology CDC" and displays a table of test results. Below this table is a "Retrieve" button and a text field containing "Average ID# 416714". The "RESULTS" section contains a detailed table with columns for Sample Id, Item, Result, Action, Range, Error, Overlimit, and Precision. The results for sample 416714 are as follows:

Sample Id	Item	Result	Action	Range	Error	Overlimit	Precision
416714	CBC_WBC	5.3					
416714	CBC_UWBC	5.3					
416714	CBC_RBC	4.98					
416714	CBC_HGB	10.1	L				<input checked="" type="checkbox"/>
416714	CBC_HCT	35.7					
416714	CBC_MCV	71.4	L				
416714	CBC_MCH	22.3	L				

At the bottom of the Results section, there is a "Comment for Sample Id# 416714" field with the value "(none)", and "Save" and "Close" buttons.

Evaluate each parameter for error, overlimit, and precision check marks, and “H” or “L” action limit, reference range flags, and comment in the above screen. Use the scroll bar to view all results. When there are check marks in any of the Precision columns, meaning that the precision limit was exceeded, rerun the blood sample a third time. If there is insufficient blood to run the CBC again (total of 4 runs, since the instrument is set to run all samples in duplicate), delete the run that caused the precision error. Save one run and comment with based on a single run. (In the above example, delete the second run for SP 416714 and save the first run.) To save the results to the database, direct the mouse arrow to the Save button and left-click. After results are saved, they are erased from the screen. To exit without saving the result to the database, direct the mouse arrow to the Close button and left-click.

Run the specimen again when any precision limit is exceeded or if one run has a comment and the second run does not.

The screenshot displays the Hematology CDC interface. The main window shows a table of test results for sample ID 784174. The table has the following columns: Id1, Date, Time, Comment, WBC, UWBC, RBC, HGB, HCT, MCV, and MCH. The data rows are as follows:

Id1	Date	Time	Comment	WBC	UWBC	RBC	HGB	HCT	MCV	MCH
745052	11/19/12	22:33:48	*	5.8	5.8	4.85	14.8	44.0	90.8	30.6
745052	11/19/12	22:43:53	*	5.6	5.6	4.84	14.7	44.0	90.9	30.3
767995	01/20/13	15:07:41	*	5.3	5.3	4.98	11.1	35.6	71.5	22.3
767995	01/20/13	15:10:19	*	5.3	5.3	4.99	11.1	35.7	71.4	22.2
784174	01/21/13	10:14:12	*	7.0	7.0	4.73	15.0	45.5	96.3	31.6
784174	01/21/13	11:28:46	*	6.7	6.7	4.81	15.0	45.9	95.5	31.3
784174	01/21/13	11:30:52	*	6.5	6.5	4.77	15.2	45.9	96.3	31.8

Below the table, there is a 'Retrieve' button and a text field containing 'Average ID#784174'. At the bottom, a 'RESULTS' section shows a table with the following columns: Sample Id, Item, Result, Action, Range, Error, Overlimit, and Precision. The data rows are as follows:

Sample Id	Item	Result	Action	Range	Error	Overlimit	Precision
784174	CBC_WBC	6.9	<input type="checkbox"/>	<input type="checkbox"/>	<input type="checkbox"/>	<input type="checkbox"/>	<input type="checkbox"/>
784174	CBC_UWBC	6.9	<input type="checkbox"/>	<input type="checkbox"/>	<input type="checkbox"/>	<input type="checkbox"/>	<input type="checkbox"/>
784174	CBC_RBC	4.76	<input type="checkbox"/>	<input type="checkbox"/>	<input type="checkbox"/>	<input type="checkbox"/>	<input type="checkbox"/>
784174	CBC_HGB	15.1	<input type="checkbox"/>	<input type="checkbox"/>	<input type="checkbox"/>	<input type="checkbox"/>	<input type="checkbox"/>
784174	CBC_HCT	45.8	<input type="checkbox"/>	<input type="checkbox"/>	<input type="checkbox"/>	<input type="checkbox"/>	<input type="checkbox"/>
784174	CBC_MCV	96.2	<input type="checkbox"/>	<input type="checkbox"/>	<input type="checkbox"/>	<input type="checkbox"/>	<input type="checkbox"/>

Run the blood sample again. Two additional results will be displayed. Whenever a sample is run more than once, all results in the SP Data section are displayed. Scroll through the top of the SP data window and determine which of the two runs match the best. Delete the 2 outlier runs, which could be the run that caused the precision error or the run that does not/does have a comment, and re-average the two remaining runs.

Lab Subsystem: Stand:616 Session:616040 01/28/2011 08:30 am - 12:30 pm

File View Utilities Quality Control Reports Modules Shipping Window Help

Hematology CDC

SPDATA	Id1	Date	Time	Comment	WBC	UWBC	RBC	HGB	HCT	MCV	MCH
	530009	11/09/12	14:50:06	*	5.1	5.6	3.96	13.0	37.6	95.1	32.8
	709532	12/08/12	09:18:14	*	4.0	5.0	4.99	15.5	44.2	88.6	31.1
	709532	12/08/12	09:20:57	*	4.0	5.0	4.93	15.5	43.7	88.6	31.4
	721160	11/09/12	14:48:06	*	4.5	5.0	3.96	13.0	37.6	95.1	32.8
	721160	11/09/12	14:50:06	*	4.5	5.0	3.96	13.0	37.6	95.1	32.8
	748968	12/28/12	08:06	*	4.5	5.0	3.96	13.0	37.6	95.1	32.8
	748968	12/28/12	08:06	*	4.5	5.0	3.96	13.0	37.6	95.1	32.8

Retrieve Average ID# 748968

RESULTS	Sample Id	Item	Result	Action	Range	Error	Overlimit	Precision

Save Close

ready | HUP: idle | MEC Layer: 12/28/2012 | Application: 13.0.0 | Not connected to Coordinator | 02:04 PM

After clearing the outlier runs, re-average the two remaining runs and analyze the results.

Override the current averaged results with a new average.

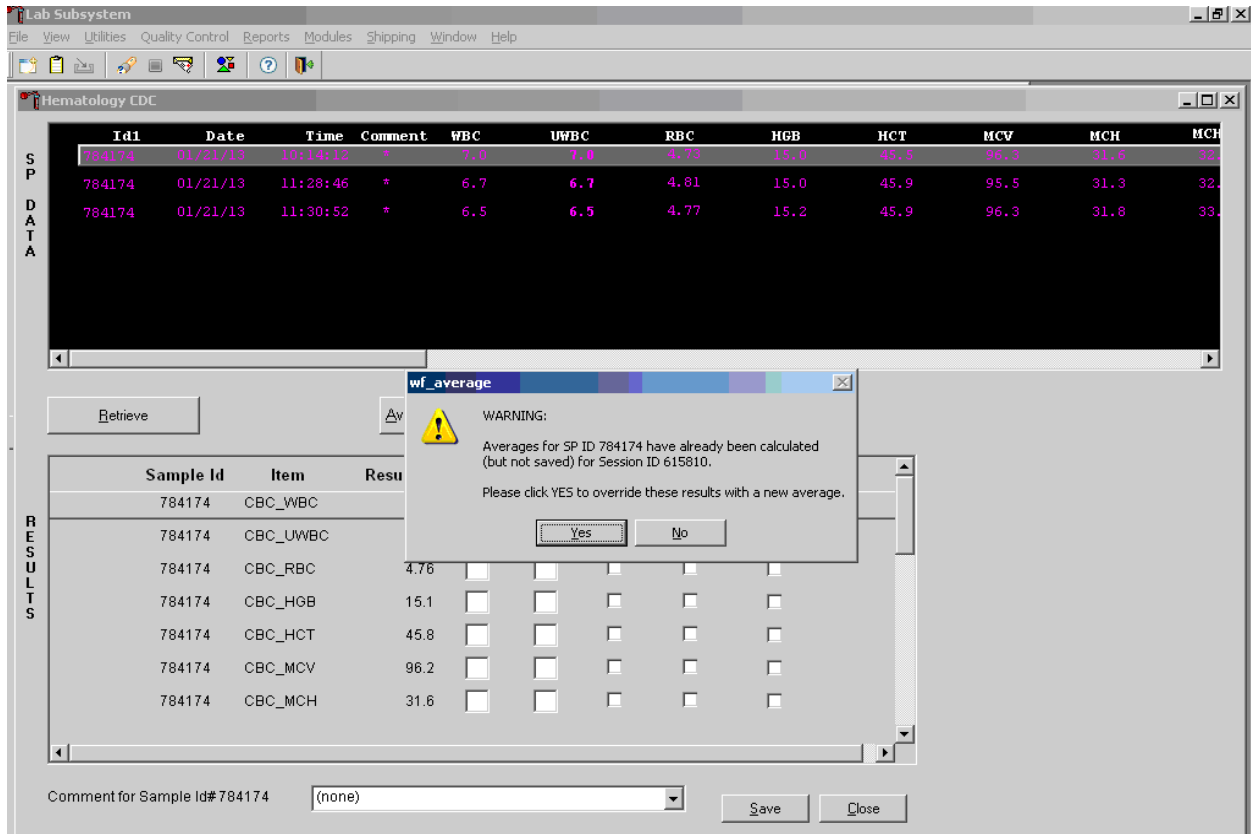

Whenever a sample has previously been averaged, and a new average is calculated, a warning message text box displays stating, “Averages for SP ID XXXXXX have already been calculated (but not saved) for session ID XXXXXX.” The text box instructs, “Please click YES to override these results with a new average.” To override the current average with a new average direct the mouse arrow to the Yes button and left-click , or press Enter. To exit or return to the previous screen containing the previous averages, direct the mouse arrow to the No button and left-click.

Evaluate the new results.

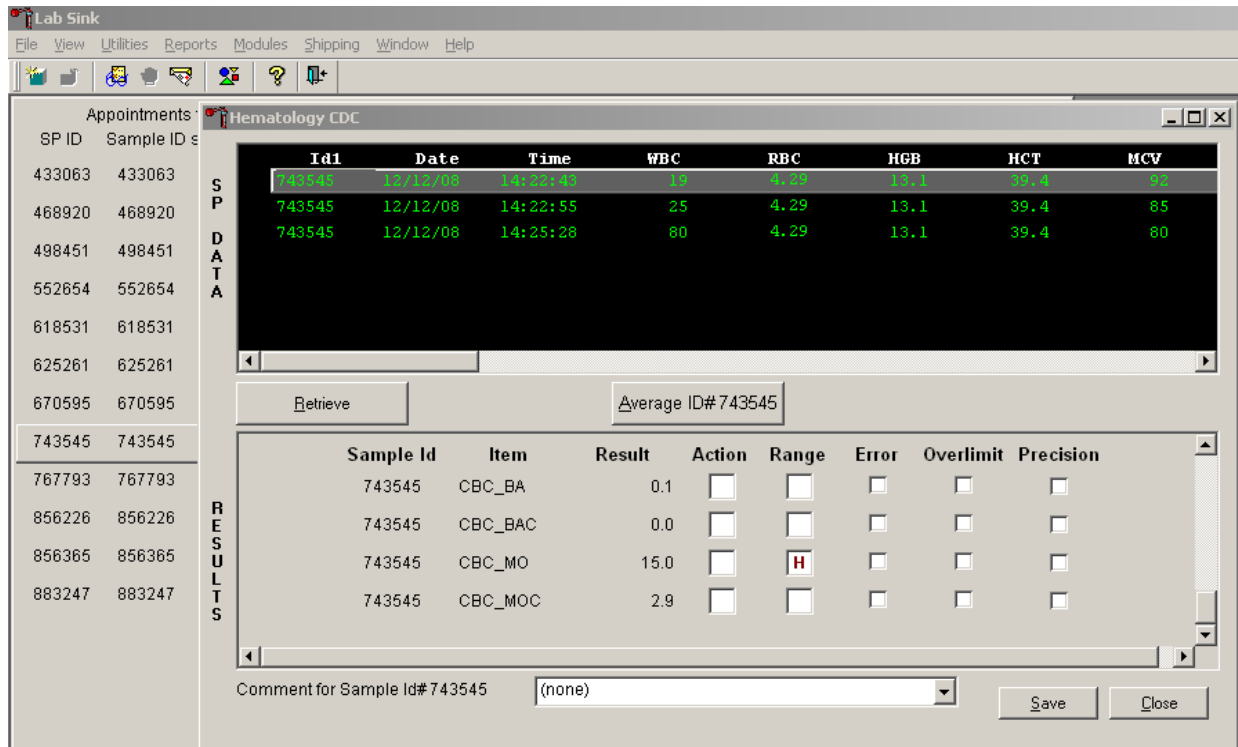

If all parameters of the two remaining runs now meet precision limits (there are no check marks in the Precision column), save the results to the database. To save the result to the database, direct the mouse arrow to the Save button and left-click. After results are saved, they are erased from the screen. To exit without saving the result to the database, direct the mouse arrow to the Close button and left-click.

If after four runs precision limits are still not met for any parameter, a comment is automatically attached to the results. Do not run a specimen more than four times.

S P D A T A

Id1	Date	Time	Comment	WBC	UWBC	RBC	HGB	HCT	MCV	MCH
745052	11/19/12	22:33:48	*	5.8	5.8	4.85	14.8	44.0	90.8	30.6
745052	11/19/12	22:43:53	*	5.6	5.6	4.84	14.7	44.0	90.9	30.3
767995	01/20/13	15:07:41	*	5.3	5.3	4.98	11.1	35.6	71.5	22.3
767995	01/20/13	15:10:19	*	5.3	5.3	4.99	11.1	35.7	71.4	22.2
784174	01/21/13	10:14:12	*	7.0	7.0	4.73	15.0	45.5	96.3	31.6
784174	01/21/13	11:28:46	*	6.7	6.7	4.81	15.0	45.9	95.5	31.3
784174	01/21/13	11:30:52	*	6.5	6.5	4.77	15.2	45.9	96.3	31.8

Retrieve Average ID# 784174

R E S U L T S

Sample Id	Item	Result	Action	Range	Error	Overlimit	Precision
784174	CBC_WBC	6.9	<input type="checkbox"/>	<input type="checkbox"/>	<input type="checkbox"/>	<input type="checkbox"/>	<input type="checkbox"/>
784174	CBC_UWBC	6.9	<input type="checkbox"/>	<input type="checkbox"/>	<input type="checkbox"/>	<input type="checkbox"/>	<input type="checkbox"/>
784174	CBC_RBC	4.76	<input type="checkbox"/>	<input type="checkbox"/>	<input type="checkbox"/>	<input type="checkbox"/>	<input type="checkbox"/>
784174	CBC_HGB	15.1	<input type="checkbox"/>	<input type="checkbox"/>	<input type="checkbox"/>	<input type="checkbox"/>	<input type="checkbox"/>
784174	CBC_HCT	45.8	<input type="checkbox"/>	<input type="checkbox"/>	<input type="checkbox"/>	<input type="checkbox"/>	<input type="checkbox"/>
784174	CBC_MCV	96.2	<input type="checkbox"/>	<input type="checkbox"/>	<input type="checkbox"/>	<input type="checkbox"/>	<input type="checkbox"/>
784174	CBC_MCH	31.6	<input type="checkbox"/>	<input type="checkbox"/>	<input type="checkbox"/>	<input type="checkbox"/>	<input type="checkbox"/>

Comment for Sample Id# 784174 (none) Save Close

Ready HUP: idle MEC Layer: 1/30/2013 Application: 13.0.3 Connected to Coordinator 03:46 PM

5. Attaching comments to the results

Enter a comment for any run where results were repeated and confirmed, the equipment failed, or there was a laboratory error.

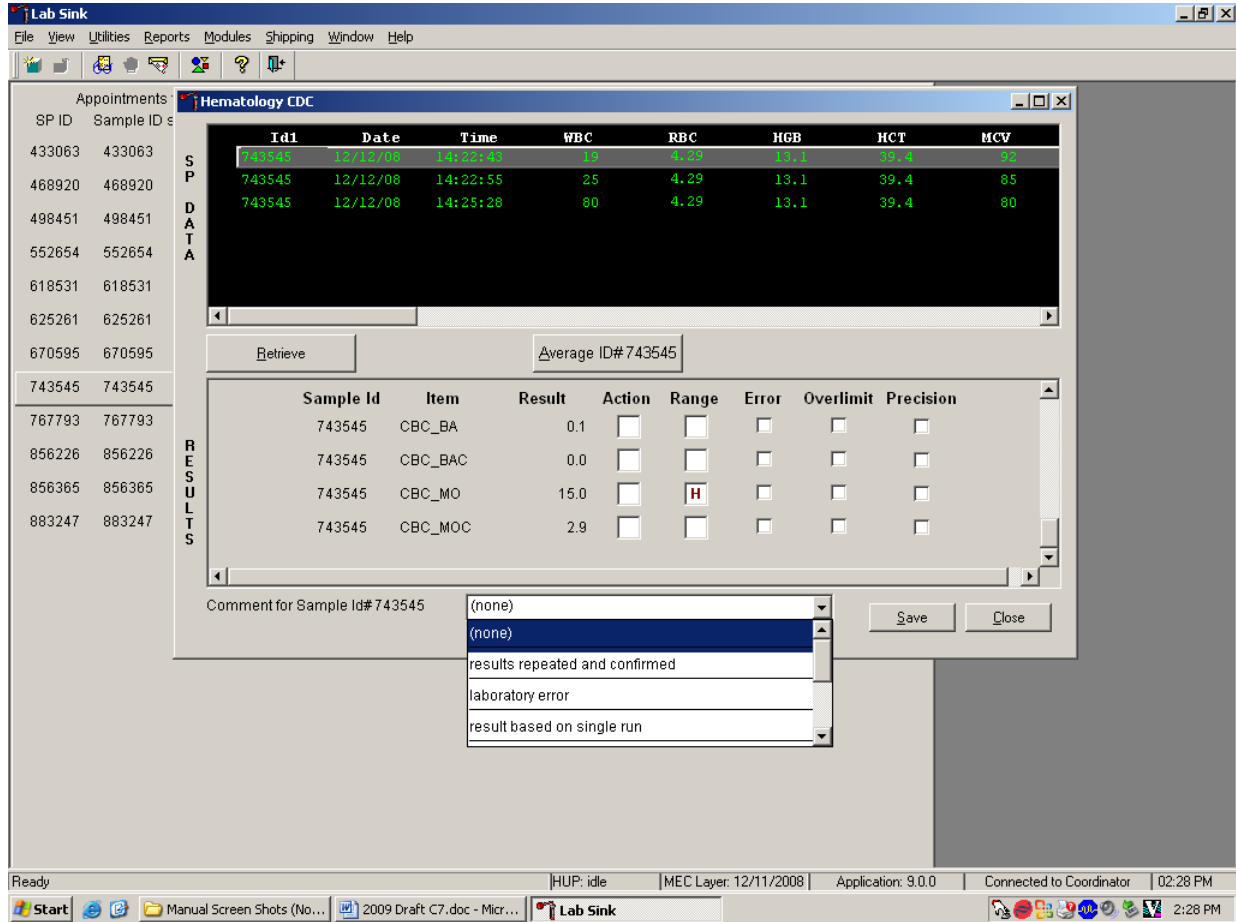

Lab Subsystem

File View Utilities Quality Control Reports Modules Shipping Window Help

Hematology CDC

Id1	Date	Time	Comment	WBC	UWBC	RBC	HGB	HCT	MCV	MCH
745052	11/19/12	22:33:48	*	5.8	5.8	4.85	14.8	44.0	90.8	30.6
745052	11/19/12	22:43:53	*	5.6	5.6	4.84	14.7	44.0	90.9	30.3
767995	01/20/13	15:07:41	*	5.3	5.3	4.98	11.1	35.6	71.5	22.3
767995	01/20/13	15:10:19	*	5.3	5.3	4.99	11.1	35.7	71.4	22.2
784174	01/21/13	10:14:12	*	7.0	7.0	4.73	15.0	45.5	96.3	31.6
784174	01/21/13	11:28:46	*	6.7	6.7	4.81	15.0	45.9	95.5	31.3
784174	01/21/13	11:30:52	*	6.5	6.5	4.77	15.2	45.9	96.3	31.8

Retrieve Average ID#784174

Sample Id	Item	Result	Action	Range	Error	Overlimit	Precision
784174	CBC_WBC	6.9	<input type="checkbox"/>	<input type="checkbox"/>	<input type="checkbox"/>	<input type="checkbox"/>	<input type="checkbox"/>
784174	CBC_UWBC	6.9	<input type="checkbox"/>	<input type="checkbox"/>	<input type="checkbox"/>	<input type="checkbox"/>	<input type="checkbox"/>
784174	CBC_RBC	4.76	<input type="checkbox"/>	<input type="checkbox"/>	<input type="checkbox"/>	<input type="checkbox"/>	<input type="checkbox"/>
784174	CBC_HGB	15.1	<input type="checkbox"/>	<input type="checkbox"/>	<input type="checkbox"/>	<input type="checkbox"/>	<input type="checkbox"/>
784174	CBC_HCT	45.8	<input type="checkbox"/>	<input type="checkbox"/>	<input type="checkbox"/>	<input type="checkbox"/>	<input type="checkbox"/>
784174	CBC_MCV	(none)	<input type="checkbox"/>	<input type="checkbox"/>	<input type="checkbox"/>	<input type="checkbox"/>	<input type="checkbox"/>
784174	CBC_MCH	(none)	<input type="checkbox"/>	<input type="checkbox"/>	<input type="checkbox"/>	<input type="checkbox"/>	<input type="checkbox"/>

Comment for Sample Id# 784174

Save Close

Ready | HUP: idle | MEC Layer: 1/30/2013 | Application: 13.0.3 | Connected to Coordinator | 03:45 PM

To attach a comment to the results in the database, direct the mouse arrow to the drop-down list on the Comment box, left-click to display the codes, drag the mouse arrow to the most appropriate choice, and left-click. Alternatively, to record a comment, direct the mouse arrow to the drop-down list on the Comment box, click to display the codes, use the up and down keyboard arrows to scroll through the choices or type the first letter of the desired comment code, and when the correct choice is highlighted, left-click.

Exhibit 6-10 presents the comments for the samples and when they are to be used.

Exhibit 6-10. List of comments to be used

Comment	Use when:
Results repeated and confirmed	Any parameter exceeded an action, range, or precision limit and the specimen (blood tube) was run more than once.
Laboratory error	There was a technologist error.
Result based on single run	The quantity of specimen is insufficient to run it more than once.
Equipment failure	The Coulter malfunctioned.
No diff results/diff vote out	The Coulter does not report parameter results for any part of the differential or the instrument reported a voteout for any of the differential parameters.
Clotted	The blood is clotted.
Not enough blood	There is insufficient blood to perform at least one complete aspiration.

Save the result after attaching a comment.

The screenshot shows the Lab Subsystem Hematology CDC interface. The main window displays a list of samples with columns for Id1, Date, Time, Comment, WBC, UWBC, RBC, HGB, HCT, MCV, and MCH. The sample 784174 is highlighted in pink. Below the list, there is a 'Retrieve' button and a text box containing 'Average ID#784174'. The 'RESULTS' section shows a table with columns for Sample Id, Item, Result, Action, Range, Error, Overlimit, and Precision. The results for sample 784174 are as follows:

Sample Id	Item	Result	Action	Range	Error	Overlimit	Precision
784174	CBC_WBC	6.9	<input type="checkbox"/>	<input type="checkbox"/>	<input type="checkbox"/>	<input type="checkbox"/>	<input type="checkbox"/>
784174	CBC_UWBC	6.9	<input type="checkbox"/>	<input type="checkbox"/>	<input type="checkbox"/>	<input type="checkbox"/>	<input type="checkbox"/>
784174	CBC_RBC	4.76	<input type="checkbox"/>	<input type="checkbox"/>	<input type="checkbox"/>	<input type="checkbox"/>	<input type="checkbox"/>
784174	CBC_HGB	15.1	<input type="checkbox"/>	<input type="checkbox"/>	<input type="checkbox"/>	<input type="checkbox"/>	<input type="checkbox"/>
784174	CBC_HCT	45.8	<input type="checkbox"/>	<input type="checkbox"/>	<input type="checkbox"/>	<input type="checkbox"/>	<input type="checkbox"/>
784174	CBC_MCV	96.2	<input type="checkbox"/>	<input type="checkbox"/>	<input type="checkbox"/>	<input type="checkbox"/>	<input type="checkbox"/>
784174	CBC_MCH	31.6	<input type="checkbox"/>	<input type="checkbox"/>	<input type="checkbox"/>	<input type="checkbox"/>	<input type="checkbox"/>

At the bottom, there is a 'Comment for Sample Id# 784174' dropdown menu with 'results repeated and confirmed' selected, and 'Save' and 'Close' buttons.

Save the averaged result and update the comment, by using the mouse to direct the mouse arrow to the Save button and left-click. To exit without saving any data to the database, direct the mouse arrow to the Close button and left-click.

6. Using alternative data manipulation choices

Retain data for multiple SPs in the SP Data section of the window.

The screenshot shows the 'Lab Subsystem' application window with the 'Hematology CDC' module active. The 'SP DATA' section displays a table of sample data with columns: Id1, Date, Time, Comment, WBC, UWBC, RBC, HGB, HCT, MCV, and MCH. The 'RESULTS' section shows a table with columns: Sample Id, Item, Result, Action, Range, Error, Overlimit, and Precision. Below the results table, there is a 'Comment for Sample Id# 784174' field with a dropdown menu showing 'results repeated and confirmed'. Buttons for 'Retrieve', 'Average ID# 784174', 'Save', and 'Close' are visible. The status bar at the bottom indicates 'Ready', 'HUP: idle', 'MEC Layer: 1/30/2013', 'Application: 13.0.3', 'Connected to Coordinator', and '03:47 PM'.

SP DATA	Id1	Date	Time	Comment	WBC	UWBC	RBC	HGB	HCT	MCV	MCH
	745052	11/19/12	22:33:48	*	5.8	5.8	4.85	14.8	44.0	90.8	30.6
	745052	11/19/12	22:43:53	*	5.6	5.6	4.84	14.7	44.0	90.9	30.3
	767995	01/20/13	15:07:41	*	5.3	5.3	4.98	11.1	35.6	71.5	22.3
	767995	01/20/13	15:10:19	*	5.3	5.3	4.99	11.1	35.7	71.4	22.2
	784174	01/21/13	10:14:12	*	7.0	7.0	4.73	15.0	45.5	96.3	31.6
	784174	01/21/13	11:28:46	*	6.7	6.7	4.81	15.0	45.9	95.5	31.3
	784174	01/21/13	11:30:52	*	6.5	6.5	4.77	15.2	45.9	96.3	31.8

RESULTS	Sample Id	Item	Result	Action	Range	Error	Overlimit	Precision
	784174	CBC_WBC	6.9	<input type="checkbox"/>	<input type="checkbox"/>	<input type="checkbox"/>	<input type="checkbox"/>	<input type="checkbox"/>
	784174	CBC_UWBC	6.9	<input type="checkbox"/>	<input type="checkbox"/>	<input type="checkbox"/>	<input type="checkbox"/>	<input type="checkbox"/>
	784174	CBC_RBC	4.76	<input type="checkbox"/>	<input type="checkbox"/>	<input type="checkbox"/>	<input type="checkbox"/>	<input type="checkbox"/>
	784174	CBC_HGB	15.1	<input type="checkbox"/>	<input type="checkbox"/>	<input type="checkbox"/>	<input type="checkbox"/>	<input type="checkbox"/>
	784174	CBC_HCT	45.8	<input type="checkbox"/>	<input type="checkbox"/>	<input type="checkbox"/>	<input type="checkbox"/>	<input type="checkbox"/>
	784174	CBC_MCV	96.2	<input type="checkbox"/>	<input type="checkbox"/>	<input type="checkbox"/>	<input type="checkbox"/>	<input type="checkbox"/>
	784174	CBC_MCH	31.6	<input type="checkbox"/>	<input type="checkbox"/>	<input type="checkbox"/>	<input type="checkbox"/>	<input type="checkbox"/>

Comment for Sample Id# 784174: results repeated and confirmed

In general, run one SP in duplicate through the Coulter, retrieve the data, average the result, and save the data to the database. The Hematology module will display data for multiple SPs in the SP Data section. Each individual SP's results or pairs of results are displayed in a different color. To select or highlight any one SP, direct the mouse arrow to the row containing the correct SP ID and left-click.

Average the results for one SP at a time.

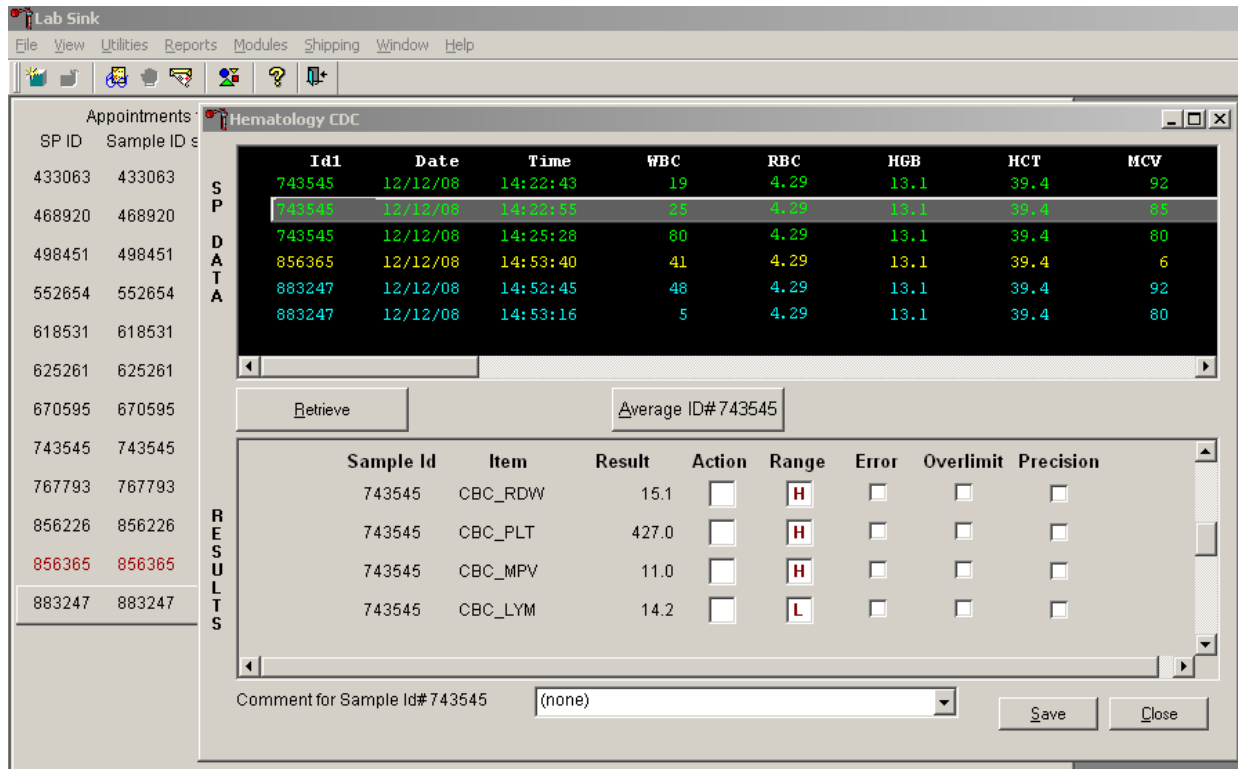

Evaluate each parameter for error, overlimit, and precision check marks, and “H” or “L” action limit and reference range flags. If there are no check marks in the Precision column (no precision limit was exceeded), save the result to the database. To save the result to the database, direct the mouse arrow to the Save button and left-click. To exit without saving the result to the database, direct the mouse arrow to the Close button and left-click. If there are any precision check marks, run a 6C cell control, evaluate the control results, rerun the blood tube a third time, re-average, evaluate, and save the results.

Use alternative data manipulation choices as desired.

Use the “Clear All Downloads” function to delete all data for all SPs in the SP Data section.

The screenshot shows the Lab Sink application window with a 'Hematology CDC' sub-window open. The sub-window contains a table with columns: Id1, Date, Time, WBC, RBC, HGB, HCT, and MCV. A context menu is open over the row with Id1 856365, showing options: 'Clear ID# 856365', 'Clear All Downloads', and 'View Log For ID# 856365'. Below the table is a 'Retrieve' button and a text field containing 'Average ID# 856365'. At the bottom of the sub-window is a table with columns: Sample Id, Item, Result, Action, Range, Error, Overlimit, and Precision. The table contains four rows of data for sample ID 743545. Below this table is a 'Comment for Sample Id# 743545' field with '(none)' selected, and 'Save' and 'Close' buttons.

Id1	Date	Time	WBC	RBC	HGB	HCT	MCV
743545	12/12/08	14:22:43	19	4.29	13.1	39.4	92
743545	12/12/08	14:22:55	25	4.29	13.1	39.4	85
743545	12/12/08	14:25:28	80	4.29	13.1	39.4	80
856365	12/12/08	14:23:40	41	4.29	13.1	39.4	6
883247	12/12/08	14:23:45	48	4.29	13.1	39.4	92
883247	12/12/08	14:23:16	5	4.29	13.1	39.4	80

Sample Id	Item	Result	Action	Range	Error	Overlimit	Precision
743545	CBC_RDW	15.1	<input type="checkbox"/>	H	<input type="checkbox"/>	<input type="checkbox"/>	<input type="checkbox"/>
743545	CBC_PLT	427.0	<input type="checkbox"/>	H	<input type="checkbox"/>	<input type="checkbox"/>	<input type="checkbox"/>
743545	CBC_MPV	11.0	<input type="checkbox"/>	H	<input type="checkbox"/>	<input type="checkbox"/>	<input type="checkbox"/>
743545	CBC_LYM	14.2	<input type="checkbox"/>	L	<input type="checkbox"/>	<input type="checkbox"/>	<input type="checkbox"/>

Lab Subsystem: Stand:616 Session:616040 01/28/2011 08:30 am - 12:30 pm

File View Utilities Quality Control Reports Modules Shipping Window Help

Hematology CDC

SP DATA	Id1	Date	Time	Comment	WBC	UWBC	RBC	HGB	HCT	MCV	MCH
	530009	11/09/12	14:50:06	*	5.1	5.6	3.96	13.0	37.6	95.1	32.8
	709532	12/08/12	09:18:14	*	4.0	5.0	4.99	15.5	44.2	88.6	31.1
	709532	12/08/12	09:20:57	*	4.0	5.0	4.93	15.5	43.7	88.6	31.4
	721160	11/09/12	14:48:06	*	4.5	5.0	3.96	13.0	37.6	95.1	32.8
	721160	11/09/12	14:50:06	*	4.5	5.0	3.96	13.0	37.6	95.1	32.8
	748968	12/28/12	02:06	*	4.5	5.0	3.96	13.0	37.6	95.1	32.8
	748968	12/28/12	02:06	*	4.5	5.0	3.96	13.0	37.6	95.1	32.8

Retrieve Average ID# 748968

RESULTS	Sample Id	Item	Result	Action	Range	Error	Overlimit	Precision
---------	-----------	------	--------	--------	-------	-------	-----------	-----------

Save Close

ready | HUP: idle | MEC Layer: 12/28/2012 | Application: 13.0.0 | Not connected to Coordinator | 02:04 PM

To clear all downloads from the SP Data section, direct the mouse arrow to any row in the SP Data section and right-click to display the alternative data manipulation choices. To select “Clear All Downloads,” drag the mouse arrow to the Clear All Downloads choice and left-click.

Release the mouse button to clear all downloads.

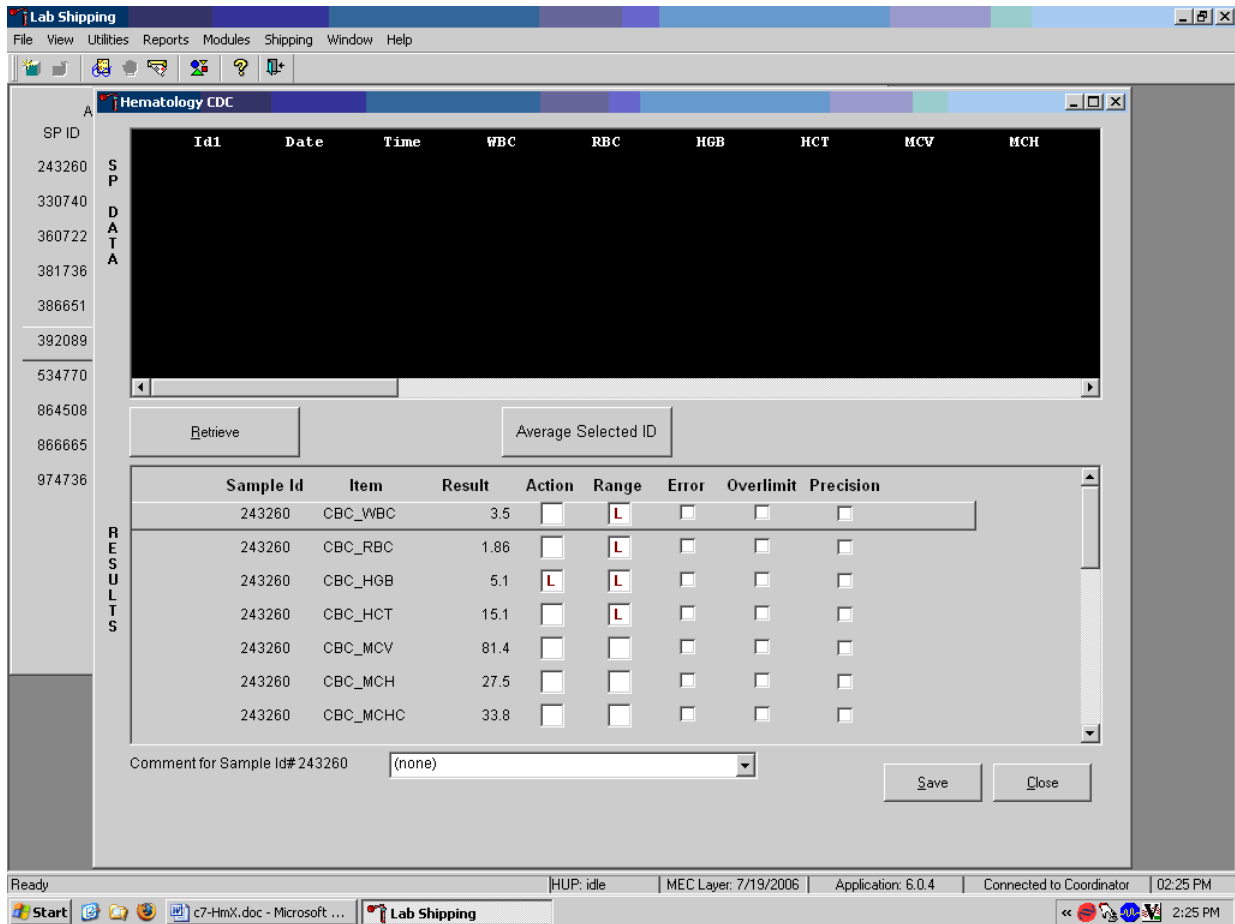

All data in the SP Data section are erased but any averaged result remains in the Results section of the window. To clear the result section, close the Hematology module. To close the Hematology module, direct the mouse arrow to the Close button and left-click.

Use the data manipulation functions to erase or delete one SP's data in the SP Data section.

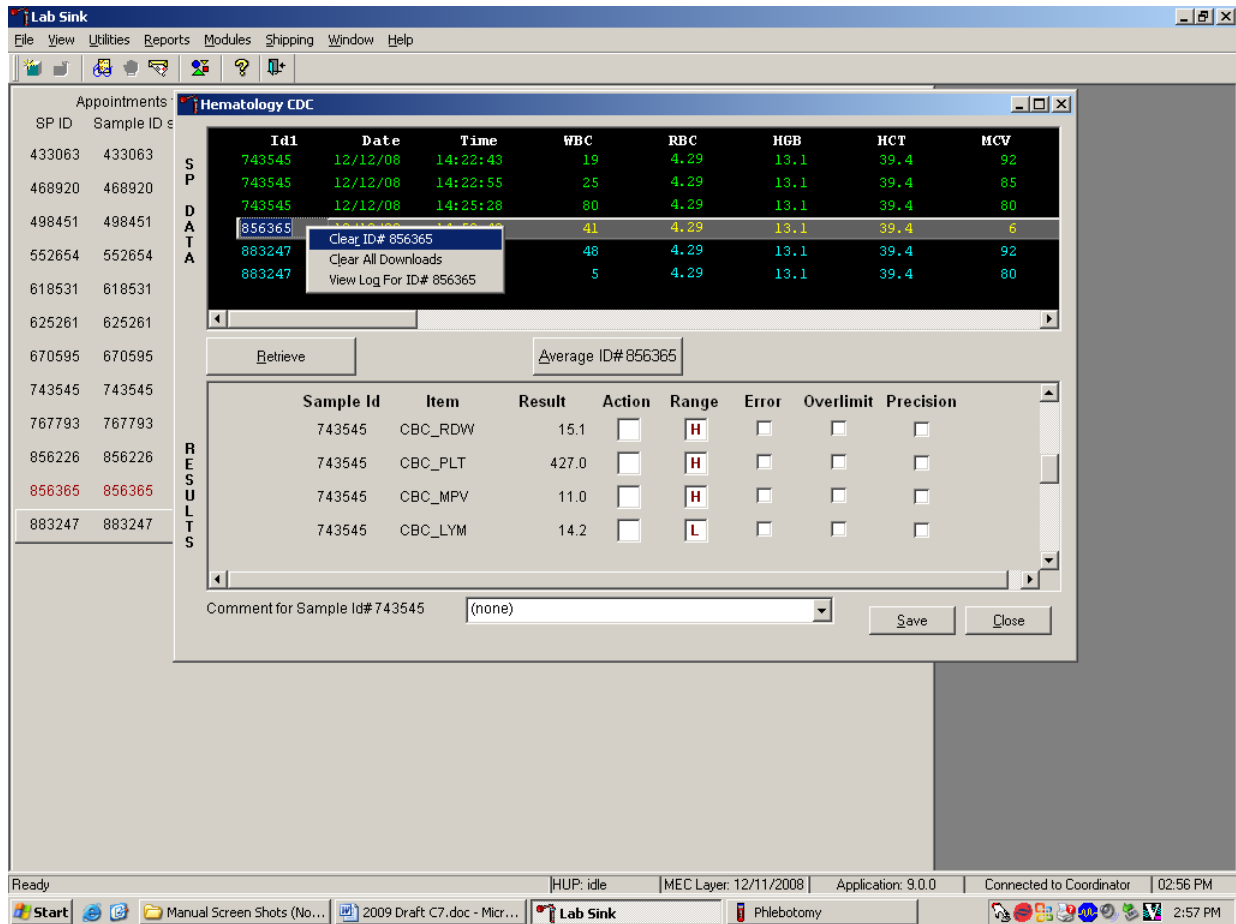

To clear the Coulter downloads for any one SP, direct the mouse arrow to the individual row in the SP Data section, right-click to display the alternative data manipulation choices, drag the mouse arrow to Clear ID#XXXXXX, and right- or left-click. Release the mouse button to clear this download. Retransmit, retrieve, average, and save the data.

Use the “View Log for ID# XXXXXX” choice to view all Coulter data, averages, and precision limit values for any SP.

The screenshot shows the Lab Sink software interface. A window titled "Hematology CDC" is open, displaying a table of patient data. The table has columns for Id1, Date, Time, WBC, RBC, HGB, HCT, and MCV. A context menu is open over the row for sample ID 743545, with the option "View Log For ID# 743545" selected. Below the table, there is a "Retrieve" button and a text field containing "Average ID# 743545". A detailed view for sample ID 743545 is shown, with columns for Sample Id, Item, Result, Action, Range, Error, Overlimit, and Precision. The results are as follows:

Sample Id	Item	Result	Action	Range	Error	Overlimit	Precision
743545	CBC_RDW	15.1	<input type="checkbox"/>	H	<input type="checkbox"/>	<input type="checkbox"/>	<input type="checkbox"/>
743545	CBC_PLT	427.0	<input type="checkbox"/>	H	<input type="checkbox"/>	<input type="checkbox"/>	<input type="checkbox"/>
743545	CBC_MPV	11.0	<input type="checkbox"/>	H	<input type="checkbox"/>	<input type="checkbox"/>	<input type="checkbox"/>
743545	CBC_LYM	14.2	<input type="checkbox"/>	L	<input type="checkbox"/>	<input type="checkbox"/>	<input type="checkbox"/>

Below the detailed view, there is a "Comment for Sample Id# 743545" field with the value "(none)" and "Save" and "Close" buttons. The Windows taskbar at the bottom shows the Start button, several open applications, and the system tray with the time 2:58 PM.

To view the detailed log for any one SP's result, direct the mouse arrow to the individual row in the SP Data section and right-click to display the alternative data manipulation choices. Drag the mouse arrow to “View Log for IDXXXXXX” and release the mouse button to view the detailed log for this SP's results.

Review the SP's log.

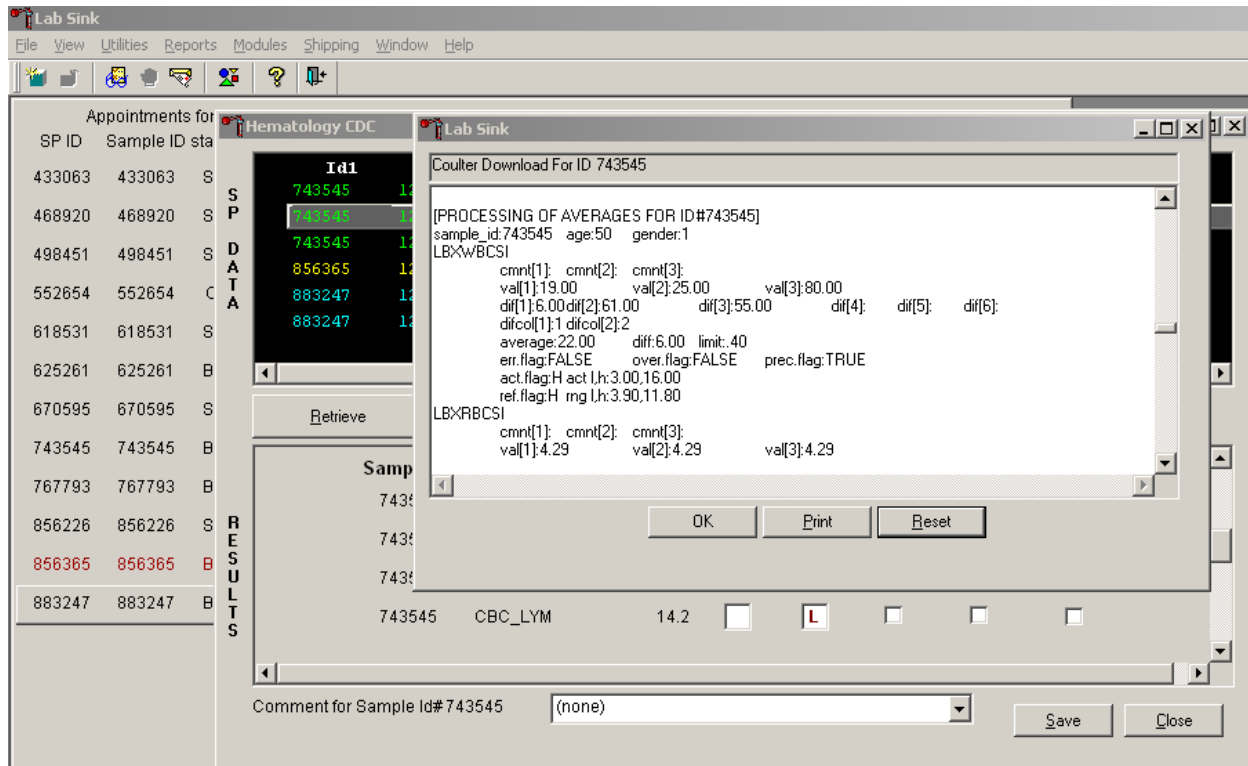

The SP's log contains detailed information for each parameter and each run. When finished reviewing the information, direct the mouse arrow to the OK button to close the window. To print the log, drag the mouse arrow to the Print button and left-click. To clear the log and close the screen, direct the mouse arrow to the Reset button and left-click, or select Enter.

6.19.3 DxH 800 Suspect Messages

- Suspect messages flag an abnormal cell distribution or population. The system generates these messages according to an internal algorithm. Specific suspect messages indicate some abnormalities that exhibit characteristic cluster patterns. Suspect messages indicate the possibility of a particular abnormality. Not every atypical scatterplot has a corresponding suspect message.
- **Remedial Action.** Rerun the specimen. If the flag is “H&H Does Not Match,” use the SP's EDTA sample from processing station, if available, as a check for proper tube filling. Delete all but two runs if flags are consistent before averaging and accepting results.

6.19.4 DXH 800 Histogram Interpretations

Exhibit 6-11 presents UniCel DxH 800 Coulter cellular analysis system cell population.

Exhibit 6-11. Cellular analysis images

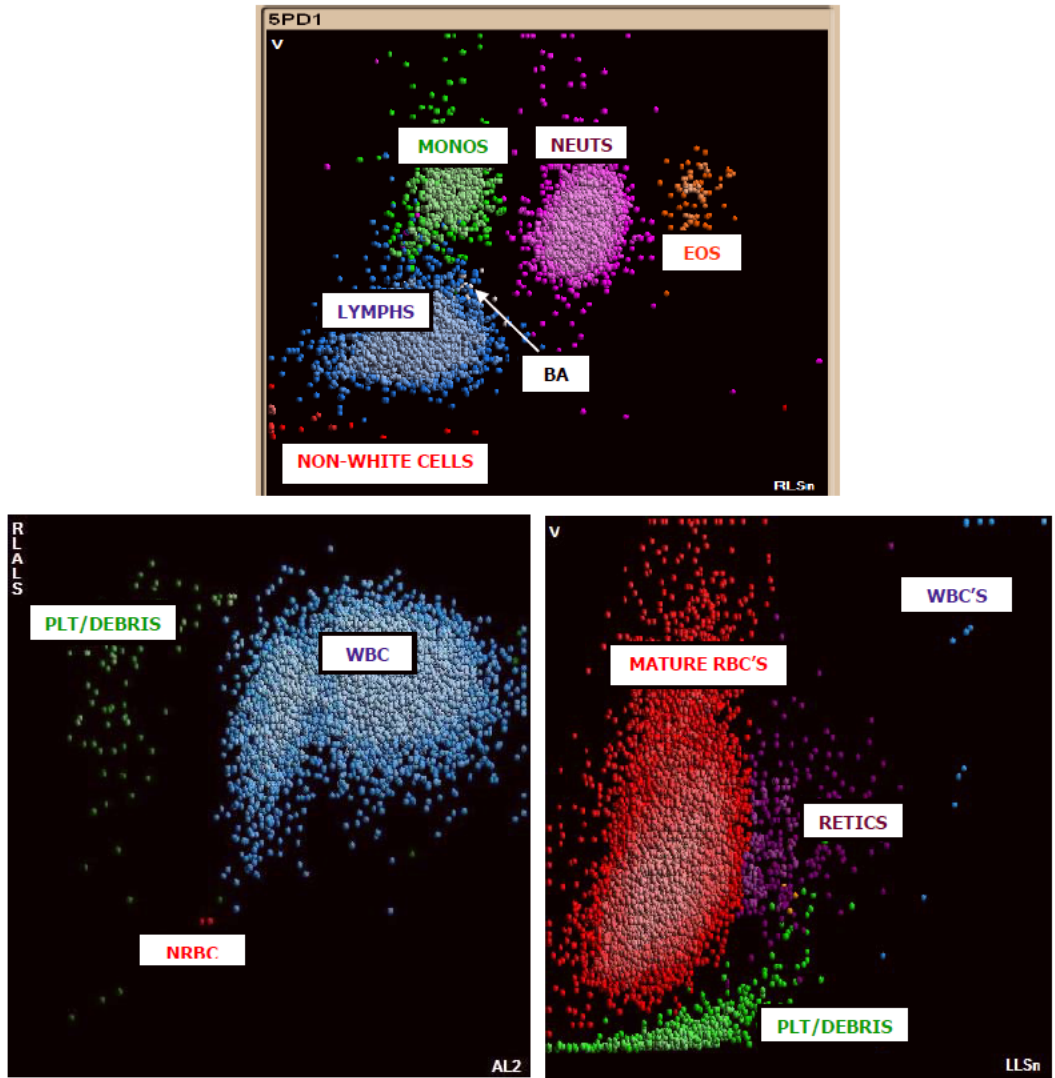

Exhibit 6-12 presents DxH system messages.

Exhibit 6-12. DxH system messages

All System messages are accompanied by “R” (Review) flags. Exceptions are the System Messages associated with an Aspiration error (P Flag) and the Non-Blood Specimen message (N Flag).

SYSTEM MESSAGE DXH	SYSTEM MESSAGE DXH
WBC	PLT
Abn WBC Pattern	Platelet Clumps
Cellular Inter	PLT Carryover
System Event: WBC	PLT Inter: Debris
WBC Carryover	RBC-PLT Overlap
RBC	System Event: PLT
Abn RBC Pattern	NRBC
System Event: RBC	Abn NRBC Pattern
HGB	AL2 Blank Volt: N
HGB Inter: WBC	DataDisc: N
HGB Blank Shift	High Event Rate: N
System Event: HGB	Low AL2 Events: N
MCV	Low DC Events: N
MCV Inter: PLT	Low Event Rate: N
MCV Inter: WBC	Low Events: N
DIFF	NRBC Inter
Abn Diff Pattern	NRBC-LY Overlap
Aged Sample	System Event: N
Data Disc: D	BF
Excessive Debris: D	Abn TNC Pattern
High Event Rate: D	System Event: TNC
High OP Events: D	TNC Carryover
High RF Events: D	P
Low Event Rate: D	Bubbles
Low Events: D	Carryover
Low OP Events: D	No Aspiration
Low RMALS Events: D	Non-blood Specimen
MO-NE Overlap	Partial Aspiration
NE-EO Overlap	Range Error
System Event: D	Unknown Error
Undefined Pop: D	:::: Code
RETIC	Flow Cell Clog: D
Abn Retic Pattern	Flow Cell Clog: N
AL2 Blank Volt: R	Flow Cell Clog: R
Data Disc: R	
High Event: R	
Low Event: R	
Nucleated Cells	
RET Inter: Debris	
RET Inter: PLT	
RET-RBC Overlap	
System Event: R	

Exhibits 6-13, 6-14, 6-15, and 6-16 respectively present red blood cell histogram examples, white blood cell histogram examples, platelets histogram examples, and an image of better abnormal cell detection.

Exhibit 6-13. Red blood cell histogram examples



RBC Histogram Examples

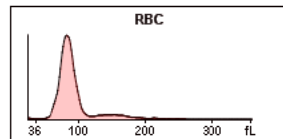

NORMAL

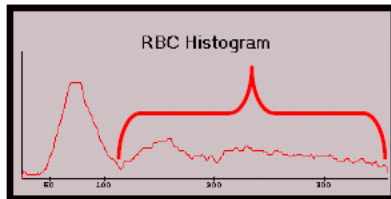

RBC AGGLUTININ

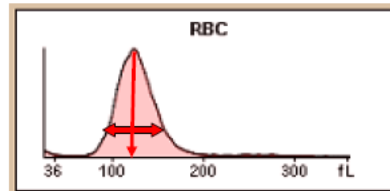

MACROCYTIC, Elevated RDW

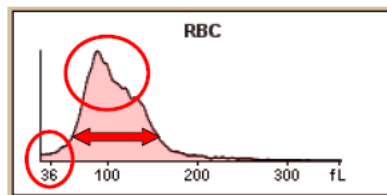

RBC Fragments / DI RBC / Elevated RDW

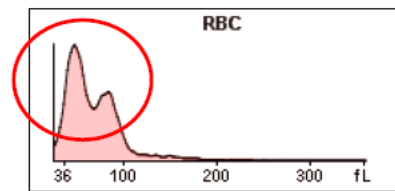

DI RBCs, RBC Frags, Elevated RDW

Exhibit 6-14. White blood cell histogram examples

WBC Histogram Examples

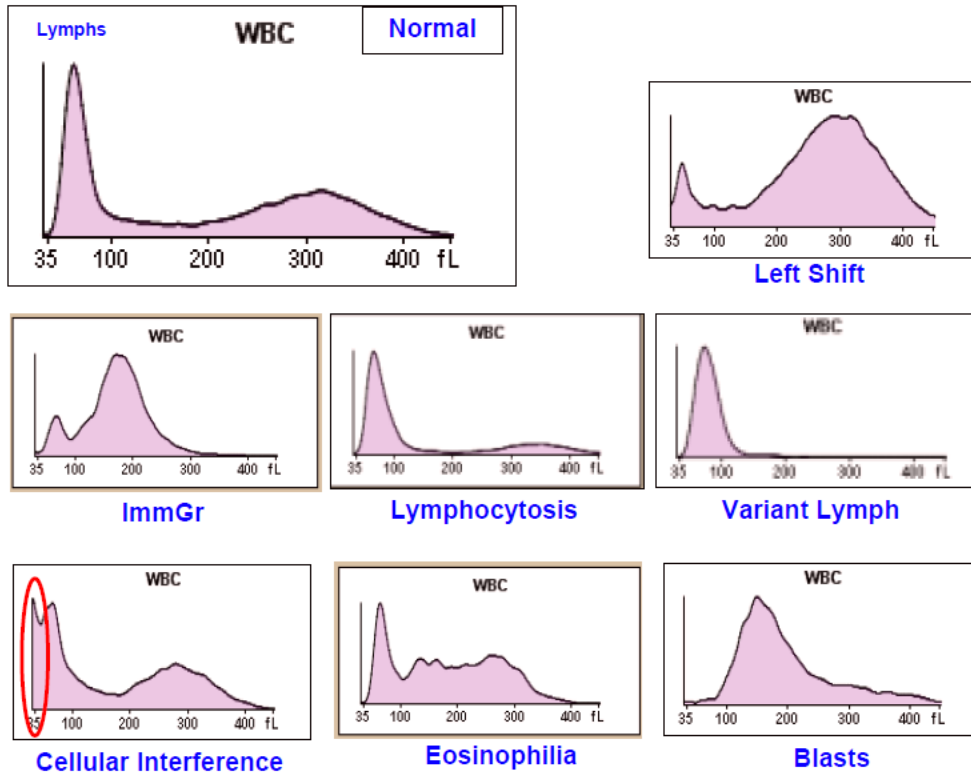
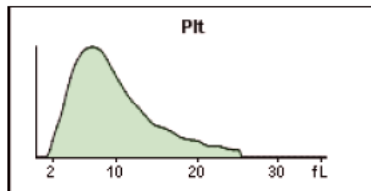

Exhibit 6-15. Platelets histogram examples

PLT Histogram Examples

Normal



Small Platelets

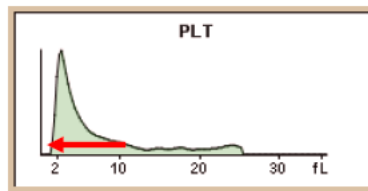

Giant Platelets

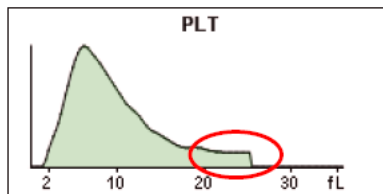

RBC/PLT Overlap

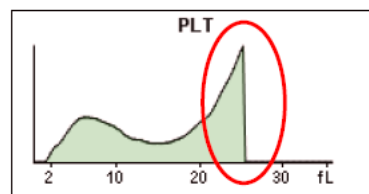
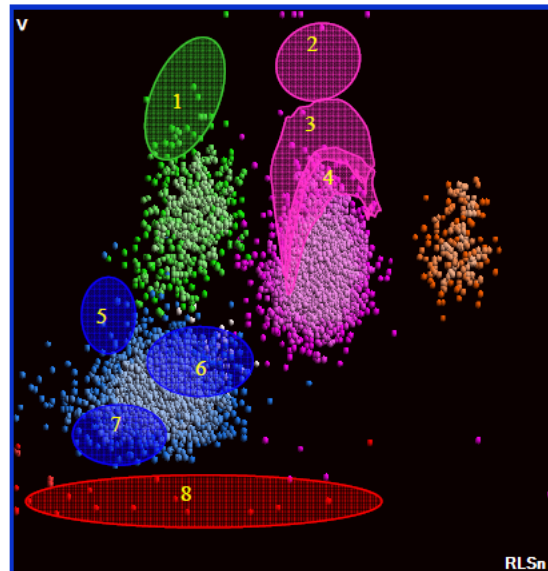

Exhibit 6-16. Image of better abnormal cell detection

Better Abnormal Cell Detection



1. MO Blasts
2. NE Blasts
3. Immature Granulocytes
4. Band Neutrophils
5. LY Blasts
6. Variant Lymphocytes
7. Small Lymphs / Low Opacity
8. Non-White Cells

6.19.5 Physician Review

The MEC physician reviews and interprets all CBC results. Results outside action limits flash and transmit to the physician immediately. The physician determines if referral for the SP for treatment is necessary. The medical technologist sends an observation to the physician whenever a critical or action limit is detected for any CBC parameter. This observation includes the date, time, responsible laboratory individual, person notified, and test results.

Send an observation on any SP scheduled into the MEC session. Access the observation function.

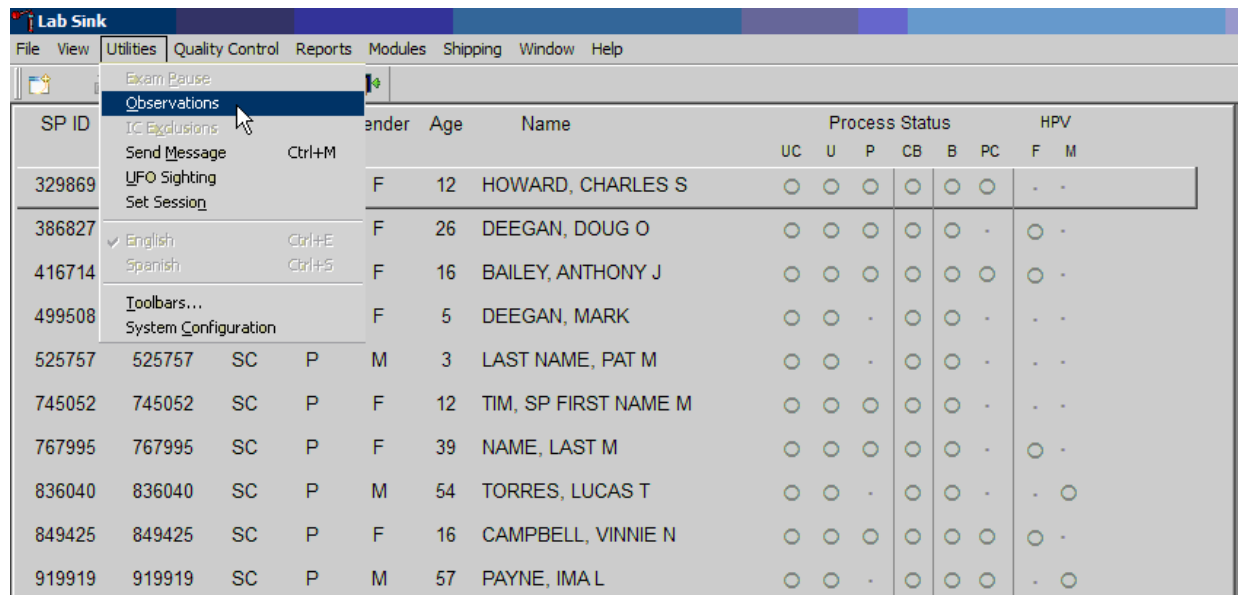

To access the observation function, direct the mouse arrow to Utilities in the menu bar, left-click, drag the mouse arrow to Observations, and left-click. Select or highlight the correct SP.

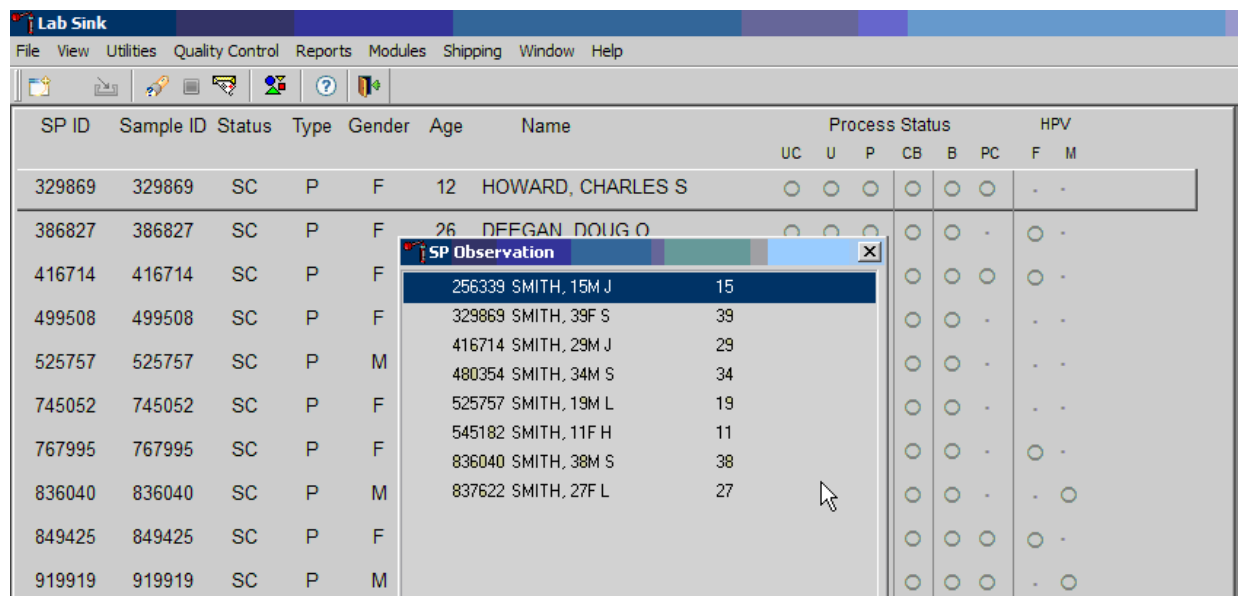

To select or highlight an SP, drag the mouse arrow to the correct SP and left-click or use the keyboard arrows to move up and down the list. Verify that the SP ID, name, and age are correct. Use the scroll bar to view the complete list of SPs. To continue, direct the mouse arrow to the OK

button and left-click, or select Enter. To cancel these actions and exit the observation function, direct the mouse arrow to the Cancel button and left-click.

The observation window displays.

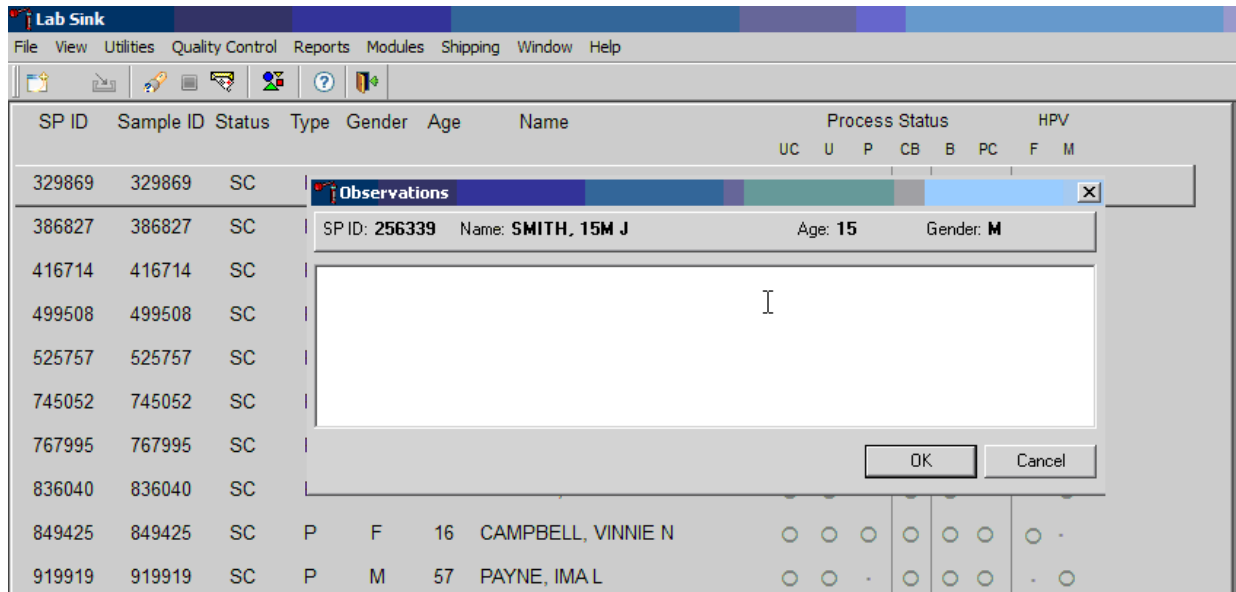

The observation window contains the SP ID, name, age, and gender. Type the observation using the keyboard. To send the observation to the physician, direct the mouse arrow to the OK button and left-click, or select Enter. To cancel these actions or to exit the observation window without entering an observation, direct the mouse arrow to the Cancel button and left-click.

Enter the observation on an SP.

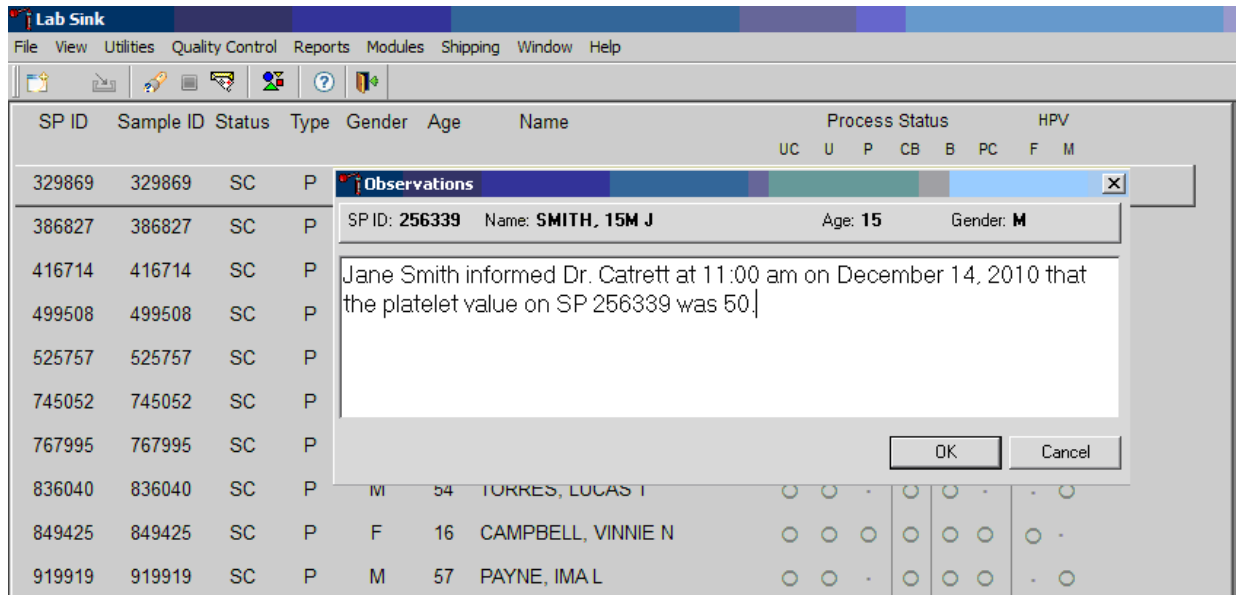

Document the date, time, responsible laboratory individual, person notified, and test results, including the parameter.

6.20 Limitations of Method: Specimen Rejection, Interfering Substances, and Conditions

This method limits samples to human whole blood.

6.20.1 Specimen Rejection

Reject clotted specimens and recollect if physician requests.

6.20.2 Interfering Substances and Conditions

Because the Coulter directly measures RBC, WBC, Hgb, and Diff percent, it is most important to concentrate on analytes and substances that interfere with these parameters. The Coulter calculates HCT, MCH, MCHC, and DIFF # parameters. The Coulter derives MCV, RDW, PLT, and MPV from RBC or platelet histograms. The following are possible interfering substances or conditions:

- Abnormal BUN, glucose, or sodium levels could affect the MCV.
- Abnormal WBCs could affect lymphocytes, monocytes, and granulocytes.
- Abnormally small WBCs could affect white count, lymphocytes, monocytes, and granulocytes.
- Clumped platelets could affect white count, lymphocytes, monocytes, granulocytes, RBC, MCV, RDW, platelet count, and MPV.
- Cryofibrinogen and cryoglobulin crystals could affect white count, lymphocytes, monocytes, granulocytes, RBC, hemoglobin, platelet count, and MPV.
- An elevated WBC count could affect RBC, hemoglobin, MCV, RDW, platelet count, and MPV parameters.
- Fragile WBCs could affect white count, lymphocytes, monocytes, granulocytes, platelet count, and MPV.
- Giant platelets could affect white count, lymphocytes, monocytes, granulocytes, RBC, MCV, RDW, platelet count, and MPV.
- Hemolyzed specimens could affect RBC, hemoglobin, platelet count, and MPV.
- Lipemic specimens could affect MCV.
- Severely icteric plasma causes increased hemoglobin.
- Nucleated RBCs could affect the white count, lymphocytes, monocytes, granulocytes, and hemoglobin values.
- WBC—certain unusual RBC abnormalities that resist lysing, nucleated RBCs, fragmented WBCs, agglutinated WBCs, any unlysed particles greater than 35 fL, very large or aggregated platelets as when anticoagulated with oxalate or heparin, specimens containing fibrin, cell fragments, or other debris such as pediatric and oncology specimens.

- RBC—very high WBC count, high concentration of very large platelets, agglutinated RBCs, RBCs smaller than 36 fL, specimens containing fibrin, cell fragments, or other debris such as pediatric and oncology specimens.
- Hgb—very high WBC count, severe lipemia, heparin, certain unusual RBC abnormalities that resist lysing, or anything that increases the turbidity of the sample such as elevated levels of triglycerides.
- MCV—very high WBC count, high concentration of very large platelets, agglutinated RBCs, RBC fragments that fall below the 36-fL threshold, or rigid RBCs.
- RDW—very high WBC count, high concentration of very large or clumped platelets as in blood anticoagulated with oxalate or heparin, RBCs below the 36-fL threshold, two distinct populations of RBCs, RBC agglutinates, or rigid RBCs.
- Plt—very small red blood cells near the upper threshold, cell fragments, clumped platelets as with oxalate or heparin, platelet fragments, or cellular debris near the lower platelet threshold.
- MPV—known factors that interfere with the Plt count and shape of the histogram or known effects of EDTA.
- Hct—known factors that interfere with the parameters used for computation: RBC and MCV.
- MCH—known factors that interfere with the parameters used for computation: Hgb and RBC.
- MCHC—known factors that interfere with the parameters used for computation: Hgb, RBC, and MCV.
- Diff Parameters—known factors that affect the WBC count as listed above or high triglycerides that affect lysing.

6.21 Reference Ranges

Tables 6-5 and 6-6 respectively present reference ranges for blood cell counts for males and females, by age.

Table 6-5. Reference ranges (males)

Age in years	1-5		6-18		19-65		66+	
	2.5	97.5	2.5	97.5	2.5	97.5	2.5	97.5
White blood cell count (SI)	4.3	14.6	3.6	11.5	3.9	11.8	3.8	12.1
Red cell count (SI)	3.98	5.3	4.14	5.78	4.18	5.86	3.57	5.67
Hemoglobin (g/dl)	10.7	14.2	11.9	16.9	13.1	17.5	11.4	17.1
Hematocrit (%)	32.1	41.7	35.3	49.9	38.7	51.4	33.9	50.9
Mean cell volume (fL)	68.2	88.8	75.6	94.6	79.8	99.1	81.4	102.7
Mean cell hemoglobin (pg)	22.3	30.6	25.0	32.3	26.3	34.0	26.3	35.0
MCHC (g/dl)	32.3	35.6	32.3	35.3	32.3	35.3	32.1	35.1
Red cell distribution width (%)	11.4	15.8	11.4	14.0	11.4	14.5	11.8	16.2
Platelet count (%) SI	212	546	179	439	152	386	124	384
Mean platelet volume (fL)	6.1	8.9	6.6	10	6.8	10.1	6.6	10.2
Lymphocyte percent (%)	22.8	68.4	17.5	54.3	16.1	47.9	12.3	46.4
Monocyte percent (%)	4.6	15.2	4.8	13.7	4.4	13.5	4.6	14.0
Segmented neutrophils percent (%)	17.6	67.1	30.3	72.8	37.8	74.6	39.5	78.1
Eosinophils percent (%)	0.7	11.3	0.7	11.5	0.7	8.5	0.6	8.8
Basophils percent (%)	0.1	2.5	0.1	1.6	0.1	1.6	0.1	1.6

Table 6-6. Reference ranges (females)

Age in years	1-5		6-18		19-65		66+	
	2.5	97.5	2.5	97.5	2.5	97.5	2.5	97.5
White blood cell count (SI)	4.3	14.0	3.9	12.2	4.1	12.9	4.0	11.6
Red cell count (SI)	3.96	5.28	3.84	5.24	3.64	5.2	3.51	5.34
Hemoglobin (g/dL)	11.0	14.2	11.2	15.1	10.6	15.6	10.9	15.9
Hematocrit (%)	32.5	41.9	33.5	44.6	32.0	45.9	32.8	47.0
Mean cell volume (fL)	70.2	89.1	74.7	94.9	74.6	98.2	80.3	100.6
Mean cell hemoglobin (pg)	23.3	30.8	24.5	32.6	24.3	33.8	26.4	34.5
MCHC (g/dl)	32.4	35.5	32.3	35.3	32.1	35.3	32.3	35.1
Red cell distribution width (%)	11.3	15.4	11.3	14.8	11.4	16.3	11.6	16.3
Platelet count (%) SI	215	547	190	446	168	441	155	428
Mean platelet volume (fL)	6.1	8.9	6.6	10.0	6.8	10.2	6.7	10.5
Lymphocyte percent (%)	21.6	68.8	17.2	54.7	14.1	47.6	13.7	46.9
Monocyte percent (%)	4.2	14.4	4.3	12.7	3.8	11.6	4.4	12.8
Segmented neutrophils percent (%)	19.4	69.5	31.9	74.3	39.8	78.1	40.9	78.1
Eosinophils percent (%)	0.6	9.9	0.6	9.9	0.6	7.3	0.6	7.5
Basophils percent (%)	0.1	2.5	0.1	1.6	0.1	1.7	0.1	1.7

Reference ranges for normal values were calculated from the NHANES data set (1999–2004) using 95 percent reference interval(s) determined nonparametrically, through ranking the observations and determining the lower (2.5th percentile) and the upper (97.5th percentile) reference limits. The nonparametric (ranking) method was used because most measured hematology parameters have a skewed, non-Gaussian distribution.

6.22 Action Limits

Action limits are a guide to inform the physician that a CBC result(s) is/are abnormal. Since all specimens are run in duplicate, there is no reason to retest the sample.

- WBC male and female (all ages) < or = to $3 \times 10^3 \mu\text{l}$ or > or = to $16.0 \times 10^3 \mu\text{l}$
- Hgb male and female (<6 years) <6.5 g/dl or >14.5 g/dl
- Hgb female (>6 years) <6.5 g/dl or >16.0 g/dl
- Hgb male (>6 years) <6.5 g/dl or >18.0 g/dl
- PLT male and female (all ages) < $50 \times 10^3 \mu\text{l}$ or > $800 \times 10^3 \mu\text{l}$

Possible causes of abnormal parameters:

- High RBC, Hgb, or HCT—dehydration, polycythemia, shock, chronic hypoxia
- Low RBC, Hgb, or HCT—anemia, thalassemia, and other hemoglobinopathies
- Low MCV—microcytic anemia
- High MCV—macrocytic anemia, liver disease
- Low WBC—sepsis, marrow hypoplasia
- High WBC—acute stress, infection, malignancies
- Low platelets—risk of bleeding
- High platelets—risk of thrombosis

6.23 Specimen Storage and Handling During Testing

Specimen Storage:

- Store specimens capped and place on a rocker at room temperature until processed. If specimens are not run during the session due to excessively high room temperature, place all specimens in a biohazard bag and place bag in a cabinet of a cool room (usually physician's room upper cabinet). Retrieve from this area when specimens can be run—then mix the specimens well before running.
- Run within 24 hours of drawing.

6.24 Alternative Method for Performing Test or Storing Specimens If Test System Fails

There is no alternative method for this test. Store EDTA tube at room temperature for no more than 24 hours. Restore the instrument to functionality and then run the specimen after thorough mixing.

6.25 Test Results Reporting System: Protocol for Reporting Action Limits

Results outside the action limits are brought to the physician's attention by sending the physician an observation and requesting a decision on "course-to-follow."

All records, including QA/QC data, will be maintained for 6 years. Use only numerical identifiers for SP results.

6.26 Quality Control Summary Statistics and Graphs

Chapter 13 includes a separate detailed description of the comprehensive quality control plan. Monitor 6C[®] cell control results for bias and maintain results for the entire study period. Compare all three instruments using the CAP proficiency results.

6.27 Troubleshooting

If the Background fails:

- If WBC, RBC, Plt fails—zap apertures, prime sweep flow several times, shutdown as last resort.
- If Differential fails—flush the flow cell.
- If Hgb fails—clean BSV, Prime CBC Module, perform Hgb blank verification, Shutdown.

If the Latron fails:

- D or N(AI2) and/or D or N(Lals) out—unlock DV x 3, flush flow cell x 3.

6.28 Setting Shift Times

From Main Screen>Click on X with Bar over it (top Menu)> XB setup(Bottom screen)> “Shifts” Tab> In “Multiple Shifts” type 08:00:00 in shift one start box> Type in 13:00:00 in Shift 2 box> Type in 23:00:00 in Shift 3 box>The “to” boxes will auto fill>Save.

6.29 Reference

UniCel DxH 800 Coulter Cellular Analysis System Instructions for Use. Beckman Coulter, Inc. Fullerton, CA 92835. www.BeckmanCoulter.com.

7.1 Introduction

The purpose of blood processing is to (1) perform a complete blood count; (2) allocate blood into vessels for storage and transport to laboratories across the United States for analysis; and (3) allocate serum into vessels for future studies and storage. The purpose of packed cell processing is to allocate washed packed cells for storage and transport to two separate analysis laboratories. Processing includes centrifuging and storing blood collection tubes; aliquoting whole blood into storage vessels; centrifuging, separating, and aliquoting plasma and serum into storage vessels; performing dilutions; washing and lysing whole blood cells; and storing the specimens.

7.2 Equipment and Supplies

The blood processing area includes two laboratory-grade refrigerators, four laboratory-grade freezers, two refrigerated centrifuges, two data terminals, a laminar flow hood, and two specimen rockers. This area also includes counter space for processing blood. Extra processing supplies are stored in cabinets and/or the trailer compartments. Exhibits 7-1 and 7-2 list nonconsumable and consumable supplies for blood processing.

Exhibit 7-1. Nonconsumable supplies for blood processing

Blood processing template (6-11/12+ and 1-2/3-5)	Nalgene cryovial racks
One Eppendorf pipette 0.2-5 ml	One Eppendorf pipettes 50-1,000 μ l
One Eppendorf pipette 5-100 μ l	Pipette charging stand
One pipette battery	50-ml and 10-ml graduated cylinder
13-mm half racks	Cube rack—4-way flipper rack
16-mm full racks	Protective eyewear
16-mm half racks	Saline squeeze bottles
Deionized water bottles	6% MPA solution

Exhibit 7-2. Consumable supplies for blood processing

Cotton swabs	Eight gallon biohazard sharps containers
Ascorbic acid 0.3 gm per vessel	Ascorbic acid 0.14 gm per vessel
Kimwipes	Bench Kote paper
Pipette tips 1,000 μ l	Pipette tips 200 μ l
Pipette tips 5-ml	Wooden applicator sticks
Zip closable bags	3.5-ml transfer pipettes nonsterile
15.0-ml transfer pipettes nonsterile	Biohazard bags 25 x 35
5-ml cryovial sterile	14-ml snap cap test tubes
Conical tubes 50-ml	2-ml cryovials sterile
2-ml cryovials non-sterile	Caps for 2-ml cryovial
Serum filters 13 mm x 4 inches	Serum filters 16 mm x 6 inches
5.25 x 5.25 x 2.0-inch cardboard boxes with 9 x 9 cardboard grid	5.25 x 5.25 x 3.0 inch cardboard boxes with 9 x 9 cardboard grid
5.25 x 5.25 x 3.0-inch cardboard boxes with 5 x 5 grid	10 x 10 three-inch boxes
5.25 x 5.25 x 5.0-inch cardboard boxes with 5 x 5 foam insert	7 x 7 two-inch cardboard boxes
10 x 10 two-inch boxes	5.25 x 5.25 x 3-inch boxes with 7x7 grid
Nonsterile, powder-free, nonlatex gloves—small, medium, large	Red cap inserts
Sterile saline	Deionized water
Sharpie pens	Lab markers—fine

7.3 Protocols

Exhibits 7-3 through 7-6 illustrate the primary study participant's (SP's) protocol for blood processing. It is extremely important to follow the processing procedures outlined in these protocols and in this manual. Specimen loss or biased results will occur if the exact procedures are not followed.

Exhibit 7-3. Primary SP's whole blood processing protocol

ID	Test name	Ages	Sample (ml)	Sample type	Collection type	Vessel type	Remarks
54	VOC Blood	12+	7.0	Whole blood	7-ml Gray	7-ml	½ subsample 1, 2, 4, 5, 10, 11
1	Lead/Cad/HG/ Se/Mn	1+	0.4	Whole blood	EDTA	2-ml sterile	Full sample
216	Cr/Co	40+	1.0	Whole blood	EDTA	2-ml sterile	Requires own 3 ml lavender tube
3	RBC Folate	1+	0.1	Whole blood	EDTA	2-ml	Dilute with 1 ml AA 1%
4	Glycohem	12+	0.4	Whole blood	EDTA	2-ml	Refrigerate
5	Mercury, ethyl & methyl	1+	0.5	Whole blood	EDTA	2-ml sterile	Full sample

Exhibit 7-4. Primary SP's plasma processing protocol

ID	Test name	Ages	Sample (ml)	Sample type	Collection type	Vessel type	Remarks
9	Glucose	12+	0.5	Plasma	Gray	2-ml	Morning SPs only

Exhibit 7-5. Primary SP's packed cells processing protocol

ID	Test name	Ages	Sample (ml)	Sample type	Collection type	Vessel type	Remarks
88	Acrylamide	6+	1.0	Packed cells	EDTA	2 ml	Wash 3 times, lyse 1/3 subsample (1, 2, 5, 11) plus adult smokers

Exhibit 7-6. Primary SP's serum processing protocol

ID	Test name	Ages	Sample (ml)	Sample type	Collection type	Vessel type	Remarks
110	Folate	1+	0.7	Serum	Red	2-ml	Add 0.05 ml AA 7%
138	Cytomegalovirus (CMV)	1-5	0.4	Serum	Red	2-ml	
99	Ferritin/TfR	1-5, 12- 49	0.3 0.4	Serum	Red	2-ml	12-49 females
70	Vitamin A, D, E & Carotenoids	1-5 6+	0.5 0.7	Serum	Red	2-ml	Add red cap inserts to SPs 1-5
79	Vitamin C	6+	0.1	Serum	Red	2-ml	Add 6% MPA solution
122	Hep Profile	6+	1.0	Serum	Red	2-ml	
87	Hepatit ab	2 3-5	0.3 0.5	Serum	Red	2-ml	Age 2-5 only
17	Cotinine	3-5 6-11 12+	0.8 1.0 1.8	Serum	Red	2-ml	
21	Lipids	6-11 12+	0.5 1.0	Serum	Red	2-ml	
11	Iron/TIBC/% Saturation	12+	0.5	Serum	Red	2-ml	
18	Biochem	12+	0.8	Serum	Red	2-ml	
23	Insulin	12+	0.5	Serum	Red	2-ml	Morning SPs only
13	CRP	1-5 12- 49	0.3 0.3	Serum	Red	2-ml	12-49 females
22	HIV	18- 59	0.8	Serum	Red	2-ml	18-59 only
24	HSV	14- 49	0.2	Serum	Red	2-ml	14-49 only
77	HPV Serum	14- 59	0.5	Serum	Red	2-ml	14-59 only
150	Aldehyde	12+	0.6	Serum	Red	2-ml	1/3 subsample 1, 2, 5, 11 plus adult smokers
32	Xtra Sera1	3-11	0.5	Serum	Red	2-ml	
33	Xtra Sera2	3-11	0.5	Serum	Red	2-ml	
34	Xtra Sera3	12+	1.0	Serum	Red	2-ml	
35	Xtra Sera4	12+	1.0	Serum	Red	2-ml	
36	Xtra Sera5	12+	1.0	Serum	Red	2-ml	
37	Xtra Sera6	12+	1.0	Serum	Red	2-ml	
29	Dioxin 1 *	12+	4.0	Serum	15-ml Red	5-ml	1/3 subsample 0, 3, 7, 10
89	Dioxin 2 *	12+	4.0	Serum	15-ml Red	5-ml sterile	1/3 Subsample 0, 3, 7, 10
90	Perfluor*	12+	1.5	Serum	15-ml Red	2-ml sterile	1/3 subsample 0, 3, 7, 10
92	BFR1^	12+	3.0	Serum	15-ml Red	5-ml sterile	1/3 Subsample 4, 6, 8, 9
93	BFR2^	12+	3.0	Serum	15-ml Red	5-ml sterile	1/3 subsample 4, 6, 8, 9

* Use pooled serum from 2-15 ml red tops to fill vessels 29, 89, and 90

^ Use serum from 1-15 ml red top to fill vessels 92 & 93

Exhibit 7-7. Guest serum processing protocol

ID	Test name	Ages	Sample (ml)	Sample type	Collection type	Vessel type	Remarks
18	Biochem	1-11	0.8	Serum	Red	2-ml	
18	Biochem	12+	0.8	Serum	Red	2-ml	

7.4 Blood Processing Age-Specific Protocols

Exhibits 7-8 through 7-12 illustrate the blood processing protocols for each primary SP by age group.

Exhibit 7-8. Blood processing protocol for primary SPs aged 1-2 years

ID	Test name	Ages	Sample (ml)	Sample type	Collection type	Vessel type
1	Lead/Cad/HG/Se/Mn	1-2	0.4	Whole blood	3-ml EDTA	2-ml sterile
3	RBC Folate	1-2	0.1	Whole blood	3-ml EDTA	2-ml
5	Mercury, Ethyl, & Methyl	1-2	0.5	Whole blood	3-ml EDTA	2-ml sterile
110	Folate	1-2	0.7	Serum	3-ml Red	2-ml
138	Cytomegalovirus (CMV)	1-2	0.4	Serum	3-ml Red	2-ml
99	Ferritin/Transferrin Receptor	1-2	0.3	Serum	3-ml Red	2-ml
70	Vitamin A, D, E, & Carotenoids	1-2	0.5	Serum	3-ml Red	2-ml
87	Hepatitis ab	2	0.3	Serum	3-ml Red	2-ml
13	CRP	1-2	0.3	Serum	3-ml Red	2-ml

Exhibit 7-9. Blood processing protocol for primary SPs aged 3-5 years

ID	Test name	Ages	Sample (ml)	Sample type	Collection type	Vessel type
1	Lead/Cad/HG/Se/Mn	3-5	0.4	Whole blood	3-ml EDTA	2-ml sterile
3	RBC Folate	3-5	0.1	Whole blood	3-ml EDTA	2-ml
5	Mercury, Ethyl, & Methyl	3-5	0.5	Whole blood	3-ml EDTA	2-ml sterile
110	Folate	3-5	0.7	Serum	7- and 3-ml Red	2-ml
138	Cytomegalovirus (CMV)	1-2	0.4	Serum	3-ml Red	2-ml
99	Ferritin/Transferrin Receptor	3-5	0.3	Serum	7- and 3-ml Red	2-ml
70	Vitamin A, D, E, & Carotenoids	1-2	0.5	Serum	3-ml Red	2-ml
87	Hepatitis ab	3-5	0.5	Serum	7- and 3-ml Red	2-ml
17	Cotinine	3-5	0.8	Serum	7- and 3-ml Red	2-ml
13	CRP	3-5	0.3	Serum	7- and 3-ml Red	2-ml
32	Extra Sera1	3-5	0.5	Serum	7- and 3 -ml Red	2-ml
33	Extra Sera2	3-5	0.5	Serum	7- and 3-ml Red	2-ml

Exhibit 7-10. Blood processing protocol for primary SPs aged 6-11 years

ID	Test name	Ages	Sample (ml)	Sample type	Collection type	Vessel type
1	Lead/Cad/HG/Se/Mn	6-11	0.4	Whole blood	4-ml EDTA	2-ml sterile
3	RBC Folate	6-11	0.1	Whole blood	4-ml EDTA	2-ml
5	Mercury, Ethyl & Methyl	6-11	0.5	Whole blood	4-ml EDTA	2-ml sterile
88	Acrylamide	6-11	1.0	Packed cells	4- ml EDTA	2 ml
110	Folate	6-11	0.7	Serum	10- and 7-ml Red	2-ml
70	Vitamin A, D, E & Carotenoids	6-11	0.7	Serum	10- and 7-ml Red	2-ml
122	Hep Profile	6-19	1.0	Serum	10- and 7-ml Red	2-ml
17	Cotinine	6-11	1.0	Serum	10- and 7-ml Red	2-ml
21	Lipids	6-11	0.5	Serum	10- and 7-ml Red	2-ml
13	CRP	6-11	0.3	Serum	10- and 7-ml Red	2-ml
32	Xtra Sera1	6-11	0.5	Serum	10- and 7-ml Red	2-ml
33	Xtra Sera2	6-11	0.5	Serum	10- and 7-ml Red	2-ml

Exhibit 7-11. Blood processing protocol for primary SPs aged 12-19 years

ID	Test name	Ages	Sample (ml)	Sample type	Collection type	Vessel type
54	VOC Blood	12-19	7.0	Whole blood	7-ml Gray	7-ml
1	Lead/Cad/HG/Se/Mn	12-19	0.4	Whole blood	4 -ml EDTA	2-ml sterile
3	RBC Folate	12-19	0.1	Whole blood	4-ml EDTA	2-ml
4	Glycohem	12-19	0.4	Whole blood	4-ml EDTA	2-ml
5	Mercury, Methyl & Ethyl	12-19	0.5	Whole blood	4-ml EDTA	2-ml sterile
88	Acrylamide	12-19	1.0	Packed Cells	4-ml EDTA	2 ml
9	Glucose	12-19	0.5	Plasma	2-ml Gray	2-ml
110	Folate1	12-19	0.7	Serum	15- and 10-ml Red	2-ml
99	Ferritin/Transferrin Receptor	12-19	0.4	Serum	3-ml Red	2-ml
70	Vitamin A, D, E, & Carotenoids	12-19	0.7	Serum	15- and 7-ml Red	2-ml
122	Hep Profile	12-19	1.0	Serum	15- and 7-ml Red	2-ml
17	Cotinine	12-19	1.8	Serum	15- and 7-ml Red	2-ml
21	Lipids	12-19	1.0	Serum	15- and 7-ml Red	2-ml
11	Iron/TIBC/% Saturation	12-19	0.5	Serum	15- and 7-ml Red	2-ml
18	Biochem	12-19	0.8	Serum	15- and 7-ml Red	2-ml
23	Insulin	12-19	0.5	Serum	15- and 7-ml Red	2-ml
13	CRP	12-19	0.3	Serum	3-ml Red	2-ml
22	HIV	18-19	1.0	Serum	15- and 7-ml Red	2-ml
24	HSV	14-49	0.2	Serum	15- and 7-ml Red	2-ml
77	HPV Serum	14-19	0.5	Serum	15- and 7-ml Red 6-ml Royal blue	2-ml
150	Aldehyde	12-19	0.6	Serum	15- and 7 ml Red	2 ml
34	Xtra Sera3	12-19	1.0	Serum	15- and 7-ml Red	2-ml
35	Xtra Sera4	12-19	1.0	Serum	15- and 7-ml Red	2-ml

Exhibit 7-11. Blood processing protocol for primary SPs aged 12-19 years (continued)

ID	Test name	Ages	Sample (ml)	Sample type	Collection type	Vessel type
36	Xtra Sera5	12-19	1.0	Serum	15- and 7-ml Red	2-ml
37	Xtra Sera6	12-19	1.0	Serum	15- and 7-ml Red	2-ml
29	Dioxin 1*	12-19	4.0	Serum	15-ml Red	5-ml sterile
89	Dioxin 2*	12-19	4.0	Serum	15-ml Red	5-ml sterile
90	Perflour1*	12-19	1.5	Serum	15-ml Red	2-ml sterile
92	BFR1^	12-19	3.0	Serum	15-ml Red	5-ml sterile
93	BFR2^	12-19	3.0	Serum	15-ml Red	5-ml sterile

* Use pooled serum from 2-15 ml red tops to fill vessels 29, 89, & 90

^ Use serum from 1-15 ml red top to fill vessels 92 & 93

Exhibit 7-12. Blood processing protocol for primary SPs aged 20+ years

ID	Test name	Ages	Sample (ml)	Sample type	Collection type	Vessel type
54	VOC Blood	20+	7.0	Whole blood	7-ml Gray	10-ml Gray
1	Lead/Cad/HG/Se/Mn	20+	0.4	Whole blood	4-ml EDTA	2-ml sterile
216	Cr/Co	40+	1.0	Whole blood	Dedicated 3-ml EDTA	2-ml sterile
3	RBC Folate	20+	0.1	Whole blood	4-ml EDTA	2-ml
4	Glycohem	20+	0.4	Whole blood	4-ml EDTA	2-ml
5	Mercury, Methyl & Ethyl	20+	0.5	Whole blood	4-ml EDTA	2-ml sterile
88	Acrylamide	20+	1.0	Packed Cells	4-ml EDTA	2 ml
9	Glucose	20+	0.5	Plasma	2-ml Gray	2-ml
110	Folate	20+	0.7	Serum	15-ml Red	2-ml
99	Ferritin/Transferrin Receptor	20+	0.4	Serum	3-ml Red	2-ml
70	Vitamin A, D, E, & Carotenoids	20+	0.7	Serum	15-ml Red	2-ml
79	Vitamin C	20+	0.1	Serum	15-ml Red	2-ml
122	Hep Profile	20+	1.0	Serum	15- and 7-ml Red	2-ml
17	Cotinine	20+	1.8	Serum	15-ml Red	2-ml
21	Lipids	20+	1.0	Serum	15-ml Red	2-ml
11	Iton/TIBC/% Saturation	12-19	0.5	Serum	15- and 7-ml Red	2-ml
18	Biochem	20+	0.8	Serum	15-ml Red	2-ml
23	Insulin	20+	0.5	Serum	15-ml Red	2-ml
13	CRP	20+	0.3	Serum	3-ml Red	2-ml
22	HIV	20-59	1.0	Serum	15-ml Red	2-ml
24	HSV	20-49	0.2	Serum	15-ml Red	2-ml
77	HPV Serum	20-59	0.5	Serum	15-ml Red	2-ml

Exhibit 7-12. Blood processing protocol for primary SPs aged 20+ years (continued)

ID	Test name	Ages	Sample (ml)	Sample type	Collection type	Vessel type
150	Aldehyde	20+	0.6	Serum	15-ml Red	2-ml
34	Xtra Sera3	20+	1.0	Serum	15-ml Red	2-ml
35	Xtra Sera4	20+	1.0	Serum	15-ml Red	2-ml
36	Xtra Sera5	20+	1.0	Serum	15-ml Red	2-ml
37	Xtra Sera6	20+	1.0	Serum	15-ml Red	2-ml
29	Dioxin 1*	20+	4.0	Serum	15-ml Red	5-ml sterile
89	Dioxin 2*	20+	4.0	Serum	15-ml Red	5-ml sterile
90	Perflour1*	20+	1.5	Serum	15-ml Red	5-ml sterile
92	BFR1^	20+	3.0	Serum	15-ml Red	5-ml sterile
93	BFR2^	20+	3.0	Serum	15-ml Red	5-ml sterile

* Use pooled serum from 2-15 ml red tops to fill vessels 29, 89 & 90

^ Use serum from 1-15 ml red top to fill vessels 92 & 93

Exhibit 7-13 illustrates the blood processing protocol for each guest.

Exhibit 7-13. Blood processing protocol for guest aged 12+ years

ID	Test name	Ages	Sample (ml)	Sample type	Collection type	Vessel type
18	Biochem	12+	0.8	Serum	3-ml Red	2-ml

7.5 Labeling Vessels

The phlebotomist and the technologist assigned to shipping are responsible for labeling vessels and assembling the blood processing racks. Use extreme care in setting up the blood processing racks and in labeling the vessels with the appropriate bar code label.

Use the following materials to set up and label blood racks:

- Rack;
- Age-appropriate processing template;
- Storage vessels of the following sizes:
 - 2.0-ml sterile vessel,
 - 2.0-ml nonsterile vessel, and
 - 5.0-ml sterile vessel;
- Barcoded SP ID labels, each containing the unique six-digit SP ID number concatenated with the vessel ID.

Prepare one blood processing rack for each SP. The tubes for which each SP is eligible are determined by their sex, appointment type, and inclusion into certain subsamples so that each SP's blood processing rack may be unique. When possible, prepare the racks at least 1 day before the SP arrives for the MEC examination.

Before each session, the technologist assigned to workstation distributes the labels, and sets out the blood processing racks. The correct bar code labels automatically print for each SP based on the SP's unique profile.

While the technologist assigned to shipping is responsible for labeling the vessels and setting up the blood processing racks, it is the blood processing technologist's responsibility to verify that each vessel has the correct label **before filling**. Do not rely only upon memory or the positioning of the vessels in a rack to indicate which vessels to fill.

Always double check:

- The SP's ID number on the bar code label;
- The vessel number on the label;
- The adhesion quality of the labels; and
- That specimens are not missing labels or incorrectly labeled.

Save and recycle unused vessels:

- If the SP does not show up for the MEC exam at the appointed date and time, then it is possible that he or she will reschedule. Store the SP's labeled vials in the clear bin or cupboard in workstation 1 until the end of the stand. If the SP has not shown up by the end of the stand, discard the unused vessels. If he or she refuses phlebotomy during a session, discard vessels from the rack.

7.6 Equipment

7.6.1 Benchtop Centrifuges

Centrifuge Function

The Beckman Coulter Allegra X-15R centrifuge is a refrigerated benchtop centrifuge that generates centrifugal forces required for a wide variety of applications. Together with the Beckman Coulter rotors designed for use in this centrifuge, the centrifuge applications include the following:

- Routine processing such as sample preparations, pelleting, extractions, purifications;
- Concentrations, phase separations, receptor binding, and column centrifugations;
- Cell isolation;
- Binding studies and separation of whole blood; and
- Rapid sedimentation of protein precipitates, large particles, and cell debris.

Each MEC laboratory contains two Allegra X-15R benchtop refrigerated centrifuges.

Safety Features

The Allegra X-15R centrifuge has been designed and tested to operate safely indoors at altitudes up to 2000 m (6,562 ft). Safety features include the following:

- An electromechanical door lock system prevents operator contact with spinning rotors and prevents run initiation unless the door is shut and locked. The door is locked when a run is in progress and can be opened only when the rotor is stopped and the LED (light-emitting diode) next to the DOOR key is lit. If there is a power failure, the door lock can be manually tripped for sample recovery.
- A steel barrier surrounds the rotor chamber to provide full operator protection.
- A rotor identification system prevents the installed rotor from running above its maximum rated speed. During acceleration the microprocessor checks the magnetic rotor identification. Speed is limited to the maximum safe speed of the identified rotor. If the system identifies a rotor different than the one entered by the user, the system displays an error message and reduces the speed to the maximum allowable speed of the rotor.
- An imbalance detector monitors the rotor during the run, causing automatic shutdown if rotor loads are severely out of balance. At low speeds, an incorrectly loaded rotor can cause imbalance. Rotor instability can also occur if the centrifuge is moved while running, or if it is not resting on a level and secure surface.

Control Panel

Exhibit 7-14 is a diagram of the centrifuge control panel.

Exhibit 7-14. Centrifuge control panel

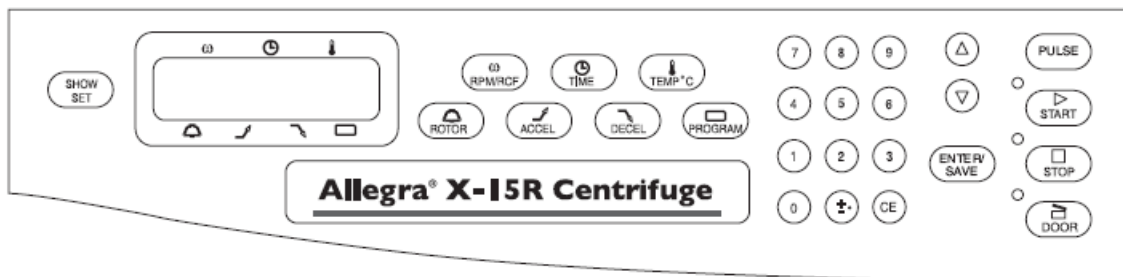











The control panel is mounted at an angle on the centrifuge front for easy visibility and access. It is used to enter run parameters via function keys and a keypad, and to display run parameters, program information, and user messages.

Digital Displays

The displays (Table 7-1) provide run information, user messages, and diagnostics.

- During a run, they show the actual (real-time) operating conditions.
- When the run parameters are being entered, they show the set values selected. Set values can be recalled during operation by pressing SHOW SET. After 5 seconds, the displays return to actual conditions.
- Error messages also appear on the displays, when applicable. The centrifuge emits a series of audible tones to alert the user to an error condition.

Table 7-1. Digital displays

SPEED 	Indicates rotor speed in revolutions per minute (rpm) or in relative centrifugal field, a term describing the ratio of the centrifugal acceleration at a specified radius and speed to the standard acceleration of gravity (RCF x g).
TIME 	In a timed run, indicates the remaining run time in hours and minutes. The time display begins counting down when ENTER/SAVE and then START are pressed and continues counting down to 0. The run automatically ends when the set time reaches 0 and deceleration begins (a tone sounds when the rotor stops spinning). If a malfunction shuts down the centrifuge during a run, when the instrument is turned back on the time will not remain and 00:00 will be displayed in the time window. By comparing this time with the original set time, you can determine when the run ended.
TEMPERATURE 	Indicates rotor temperature in degrees C at thermoequilibrium.
ROTOR 	Displays the name of the selected rotor.
ACCEL 	When the (ACCEL) key is pressed, one of 10 available acceleration rates can be entered. Displays the selected acceleration rate throughout the run. Use 10 accelerations.
DECEL 	When the (DECEL) key is pressed, one of 11 available deceleration rates can be entered. Displays the selected deceleration rate throughout the run. Use 10 decelerations.
PROGRAM 	During setup—when the (PROGRAM) key is pressed, a program number (one of 10 possible) can be selected and program parameters entered. During centrifugation—the number of the program being run is displayed.
	Pressing (ENTER/SAVE), then (START) begins the run. (START) must be pressed within 5 seconds of pressing (ENTER/SAVE). This key combination can also be used to abort a deceleration process and restart the centrifuge.
	Can be pressed at any time while the rotor is spinning to terminate a run. The centrifuge decelerates to a complete stop according to the deceleration setting. The green light next to the key flashes while the rotor decelerates. A tone sounds when the rotor comes to a complete stop.
	Unlocks and opens the door. (The instrument will not accept the unlock command if the rotor is spinning.)

Time

For plasma and serum—set appropriate time and temperature for each tube as follows:

- | | | |
|----------------------------------|------------|--------|
| - 3-ml or 4-ml EDTA | 10 minutes | 4-8 °C |
| - 2-ml gray | 10 minutes | 4-8 °C |
| - 3-ml, 7-ml, 10-ml or 15-ml red | 15 minutes | 4-8 °C |

For washed packed cells—set appropriate time and temperature for each tube as follows:

Vessel 88	3- or 4-ml EDTA	5 minutes	4-8 °C
-----------	-----------------	-----------	--------

Speed

For plasma and serum—set the speed at 2,900 rpm.

For washed packed cells vessel 88—set the speed at 1,985 rpm.

Run Procedure

Manual run

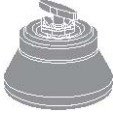
1	POWER	Turn the power switch on (I).
2	DOOR	Press DOOR to open the chamber door; lift the door open.
3		Install the rotor according to the applicable rotor manual, then close the chamber door.
4	ROTOR	Press ROTOR , then press ROTOR again or use the arrow keys to select the rotor.
5	RPM/RCF	Press RPM/RCF , then use the keypad to enter the run speed. Press RPM/RCF a second time to toggle between RPM and RCF modes, RPM/RCF RPM/RCF.
6	TIME	Press TIME , then use the keypad to enter the run time (to 99 hours, 59 minutes); or press TIME twice to toggle between hold (continuous) run and set time mode.
7	TEMP °C	Press TEMP °C , then use the keypad to enter the required run temperature -10 to +40 °C.
8	ACCEL	Press ACCEL , then use the keypad or arrow keys to enter the selected acceleration rate number, 1 (SLOW) through 10 (MAX).
9	DECEL	Press DECEL , then use the keypad or arrow keys to enter the selected deceleration rate number, 0 (OFF) through 10 (MAX).
10	ENTER/SAVE START	Check that all parameters are correct and that the door is closed (door LED will be lit). Press ENTER/SAVE , then press START (within 5 seconds).
11	STOP	Wait for the set time to count down to zero, or end the run by pressing STOP .
12	DOOR	When the rotor stops (a tone sounds and the DOOR LED lights), press DOOR to open the chamber door; lift the door.

Programmed run

1	POWER	Turn the power switch on (I).
2	DOOR	Press DOOR to open the chamber door.
3		Install the rotor according to the applicable rotor manual, then close the chamber door.
4	PROGRAM	Press PROGRAM , use the keypad or arrow keys to enter the required program number, then press ENTER/SAVE .
5	ENTER/SAVE START	Check that all parameters are correct and that the door is closed (door LED will be lit). Press ENTER/SAVE , then press START (within 5 seconds).
6	STOP	Wait for the run to end, or end the run by pressing STOP .
7	DOOR	When the rotor stops (a tone sounds and the DOOR LED lights), press DOOR to open the chamber door; lift the door.

Preparation

Prepare the rotor for centrifugation as described in chapter 13.5 in Chapter 13. For runs at other than room temperature, refrigerate or warm the rotor beforehand for fast equilibration.

Installing the Rotor

- The power must be turned on before you can unlock and open the chamber door. (To end a run for any reason, do not turn the power switch off; press STOP instead.)
- Turn the power switch on. The control panel display shows “Allegra X-15R” and the software version.
- Press DOOR. The centrifuge will accept this command only when the rotor is at rest and the DOOR LED is lit. The door opens and the LED goes out.
- Install the rotor.. Ensure that the rotor is seated on the drive hub. Avoid bumping the control panel keys during rotor installation or removal.
- Close the chamber door by pressing down firmly on both sides. The door locks. When the latches engage, the LED next to the DOOR key lights up.

NOTE: For Allegra X-15R Centrifuge cleaning and maintenance, refer to section 13.5 in Chapter 13.

End of Stand Centrifuge Packing Procedure

Remove rotors from the Allegra X-15R centrifuges and pack in plastic bins designed for rotor storage, for safe traveling. The balance detection mechanism is very sensitive during travel and needs to be protected. See photos (Exhibits 7-15 and 7-16) for proper packing.

Exhibit 7-15. Packing rotors in plastic bin (1)



Exhibit 7-16. Packing rotors in plastic bin (2)



7.6.2 Laminar Flow Biological Safety Cabinet Operating Sequence

- Turn on the cabinet blower and lights, and check the air intake and exhaust portals of the cabinet to make sure they are unobstructed.
- Check the pressure on the manometric gauge. If the pressure has increased more than 0.1 w.g. since the previous reading, notify the FES who may need to have a service engineer visit. Record the pressure reading and any comments in the Laboratory QC module.

- Allow the blowers to operate for a minimum of 15 minutes before beginning work in the cabinet.
- Disinfect the interior of the workspace by wiping it down with a disinfectant (Sani-wipe).
- Place a disposable paper blotter on the work surface. Set up the equipment for processing. Do not place any equipment or supplies over the front intake grills.
- Arrange and separate clean and contaminated materials.
- Wait 2 to 3 minutes after placing the materials and supplies in the cabinet before beginning work. This will rid the area of all “loose” contamination.
- Wear a long-sleeved laboratory coat and gloves. This will minimize the shedding of skin flora into the work area and concurrently protect hands and arms from viable agent contamination. Wash hands with soap and water before and after working in the cabinet.
- After completing work, leave the blower on for 2 to 3 minutes to purge the unit.
- Decontaminate interior surfaces after removal of all specimens and biohazard waste by wiping them with a 10 percent solution of bleach and water (1:10).
- Check the grills and diffuser vents for spills or splashes and clean using appropriate techniques and materials.

7.7 Blood-Processing Procedures

Centrifuge all blood specimens unopened, then transport to, and uncap and process in, the laminar flow hood. The laminar flow hood provides a HEPA-filtered, recirculated mass airflow within the workspace and protects from any spattering that may occur when opening the Vacutainer® tubes or when pouring or pipetting the specimens. It also prevents drawing contaminated air or dust over the specimens. It is mandatory to use the blower.

Always wear gloves when handling specimens. Check gloves for small holes or tears. Change gloves if they become visibly contaminated with blood. Immediately soak visibly contaminated racks in 1:10 bleach solution. Decontaminate the workstation, including the biological safety hood, using Sani-wipes or a 10 percent bleach solution at the end of the day or immediately when spills occur.

Decontaminate racks by soaking them in a 10 percent bleach solution at the end of each session. Decontaminate the templates by wiping with a Sani-Cloth. Place on blotter to air dry.

7.7.1 Eppendorf Xplorer Plus Pipettes

Pipette whole blood and pooled serum and make dilutions using the Eppendorf Xplorer Plus pipettes. Pipette plasma using plastic transfer pipettes.

The MEC laboratory has three Eppendorf Xplorer Plus electronic pipettes: one 5-100 μ l, one 50-1,000 μ l, and one 0.2-5 ml (Table 7-2). The lab also uses 100 μ l and 1,000 μ l Biopur pipette tips and 5-ml bulk pipette tips. Charge the pipettes in the four-stand charger.

- Use the 5-100 μ l pipette (yellow) in the (FIX) mode and select 100 μ l as the volume. . Use this pipette to aliquot the whole blood for RBC Folate – vessel 3. Select 50 μ l volume to aliquot the ascorbic acid (7% solution) for Folate 1 – vessel 110.
- Use the 50-1,000 μ l (blue) pipette in the () mode and set the volume to 1,000 μ l. Use this pipette to aliquot the 1% ascorbic acid solution for RBC Folate – vessel 3.
- Use the 0.2 – 5 ml (purple) pipette in the PRG mode. Set the volumes to match the age-specific processing protocols. Set program 1A-1D to match the adult profile for vessels 110-37. Set program 3 to match the child’s profile ages 1-2. Set program 4 to match the child’s profile ages 3-5. Set program 5A-5B to match the child’s profile ages 6-11. Use this pipette to aliquot pooled serum.

Table 7-2. Eppendorf Research Pro Electronic pipettes technical data

Pipette	Tip	Mode	Volume	Matrix
5-100 μ l	200 μ l	PRG	100 μ l	Whole blood
			50 μ l	7% Ascorbic acid
50-1,000 μ l	1,000 μ l	PIP/PRG	200 μ l	Serum
			500 μ l	Serum
			700 μ l	Serum
			1,000 μ l	1% Ascorbic Acid
0.2 – 5 ml	5 ml	PRG	Program 12+	Pooled serum
			Program 3 – 1-2	
			Program 4 – 3-5	
			Program 5 – 6-11	

7.7.1.1 Safety Precautions, Handling, and Battery for the Xplorer Plus

Before using the Xplorer Plus for the first time, please read the entire **Eppendorf Xplorer Plus Instruction Manual**.

Observe the following points:

Handling

- Use the Xplorer Plus only when a pipette tip is attached.
- Do not lay down the Xplorer Plus when a filled pipette tip is attached.
- After liquid has been aspirated, press the Actuate key only when you are sure the liquid will be dispensed correctly.
- When the pipette is switched on and when the Reset key is pressed, the piston may move. Please ensure beforehand that the liquid in the pipette tip will be dispensed correctly.
- Emergency stop: pressing the Reset key can stop a moving piston.
- Operate the Xplorer Plus at temperatures between 15°C and 30°C. Operate at a maximum humidity of 80% at a temperature up to 31°C.

Battery

- Charge the battery before operating the device for the first time.
- Charge the battery in the pipette only, using the charging stand and the original power unit.
- If a flashing battery symbol appears in the display, stop dispensing and charge the battery.
- When charging the battery, do not allow it to be exposed to any metallic surfaces.
- Dispose of used batteries as special waste.
- Never charge the Xplorer Plus without a battery.

7.7.1.2 Technical Data for the Xplorer Plus

Table 7-3 presents the technical data for the Xplorer Plus.

Table 7-3. Single channel pipette technical data

Volume range	Increment μ l	Color code	Pipette tip	Test volume	Systematic error %	Random error %
5-100 μ l	0.1	Yellow	2 - 200 μ l	100 μ l	± 0.8	± 0.2
50-1,000 μ l	1	Blue	50 - 1,000 μ l	1,000 μ l	± 0.6	± 0.2
0.2-5 ml	5	Purple	0.1 - 5-ml	5 ml	± 0.6	± 0.15

The technical data are valid only when the Xplorer Plus is used with Eppendorf pipette tips.

- Test conditions and test evaluation in compliance with ISO 8655, Part 6. Test using a standardized fine balance with a moisture trap;
- Check the volumes in the PIP mode; keep the rocker pressed during the blow-out;
- Number of determination: 10;
- Test at $20^{\circ}\text{C} - 25^{\circ}\text{C} \pm 0.5^{\circ}\text{C}$;
- Set speed level: 5;
- Dispense against the tube wall; and
- Use water in accordance with ISO 3696.

Battery

- Lithium polymer battery: 750 mAh/3.7 V
- Charging time: approximately 3 hours for a fully discharged battery; overcharging protection with the pipette

Power Unit

- Input voltage 100 V to $240 \pm 10\%$, 50/60 Hz
- Output voltage: 5 V, 1 A

Delivery Package

The Xplorer Plus is supplied as a single-channel pipette for different volume ranges. The pipette is delivered without a charging adapter, but each lab is supplied with a charging stand. Each package contains the following:

- Charging stand with separate power unit;
- Special tool(s) according to pipette type;
- Operating manual with measuring protocol and CE conformity assurance document; and
- Lithium polymer battery .

Inserting the Battery

Charge the battery in the pipette. Make sure the battery is plugged in on the Xplorer pipettes. The battery should be charged by using the charging stand with the original power unit. Do not try to recharge a pipette if the battery is not installed. A new battery does not attain its full capacity until several complete charging/discharging cycles have been completed.

For charging purposes, place the pipette in the charging stand. During the charging process a flashing rechargeable battery will flash in the display. The display is switched on during the charging process, to monitor the flashing rechargeable battery. During charging, the dispensing function is frozen. When the charging process has finished, the battery symbol appears in the display without moving.

When the pipette has been fully charged, it may remain in the charging stand. If the rechargeable battery is almost completely discharged, the display will only switch on after a slight delay. To avoid

accidental discharge, remove the battery from the Xplorer plus during extended periods of nonuse. In this case, all data remain stored.

7.7.1.3 Operating Principle

Display and Keypad

- To switch on: Switch on the ON switch (Exhibit 7-17).
- To switch off: Switch off the ON switch.
- When unit is on and not in use, it will automatically switch to the standby mode after a period of time. The pipette will automatically switch back on when it is moved.
- To set date and time:
 1. Select Date or Time using the rocker.
 2. Press the Select softkey.
 3. Change the value using the rocker.
 4. Press the Next softkey to change the field.
 5. Press the End softkey to end the entry.
 6. Change the second parameter in the same manner.
 7. Press the End softkey to end the entry.

Exhibit 7-17. Illustration of single channel pipette

3.1 Main illustration – single-channel pipette

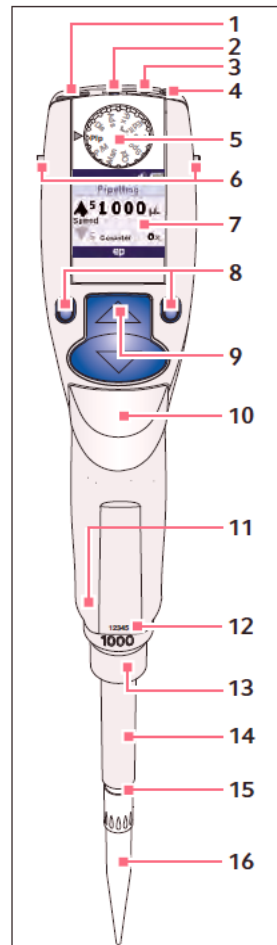

- 1 USB port**
- 2 On/Off key**
- 3 Reset key**
- 4 Connector socket**
Connects the charging plug of the power supply.
- 5 Selection dial**
Sets the operating mode.
- 6 Charging contacts**
For charging and storage in a series 4880 charger stand or charger carousel.
- 7 Backlit color display**
Switches the display off when it is not in use. The display automatically switches back on when the pipette is moved.
- 8 Softkeys**
The assignment of the respective softkey is shown in the display footer.
- 9 Rocker**
You can either press the rocker up or down. The rocker can either be used to trigger the piston movement or to scroll through the menu and change the values of parameters.
- 10 Ejector**
Moves the ejector sleeve and ejects the pipette tip. After a filled pipette tip has been ejected, the piston returns to the basic position after a slight delay.
- 11 RFID chip**
- 12 Upper part serial number**
- 13 Lower part serial number**
Located under the ejector sleeve.
- 14 Ejector sleeve**
- 15 Spring-loaded tip cone**
The spring-loading action optimizes the force required for attaching and ejecting tips. The spring-loading action is available for all Xplorer pipettes up to 1000 µL.
- 16 Pipette tip**
Only use the pipette with a suitable pipette tip. We recommend epT.I.P.S.

7.7.1.4 Principle of Operation

The Xplorer Plus pipette is equipped with various operating modes and a primary mode for configuring the pipette. During operation, the piston in the pipettes is moved according to how the rocker is actuated. When you press the rocker up, the piston in the pipette moves up. Liquid is aspirated into the attached pipette tip. When you press the rocker down, the piston in the pipette moves down. The liquid is dispensed into the pipette tip.

Contact Surface on the Head of the Pipette

Both upper surfaces are required for charging the lithium polymer battery. The lower surfaces are the data interfaces for the service department. The contact to the charging adapter or the charging stand cannot be confused with any other contacts.

Acoustic Signals

Certain signals assist the user for different operations:

- Short signal acknowledges that the keypad has been pressed;
- Slightly higher tone indicates that the function for which the key has been pressed cannot be executed;
- Louder tone indicates that the piston movement has ended;
- Louder tone indicates that a specific sequence of steps (e.g., dispensing) has ended; and
- Louder tone indicates an error message.

The acoustic signals are a great help when you are familiarizing yourself with the operating procedure of the Research pro. They can be switched off if required.

7.7.1.5 Programming the Pipettes

PIP Mode

Use this mode for ascorbic acid [50-1,000 μ l] pipette. Use 1,000 μ l volume only.

Programming - PIP	
Step 1	Select the pipetting mode PIP. Turn the dial until the PIP choice appears.
Step 2	Press the small blue "EDIT" button on the left.
Step 3	Select the desired volume.
Step 4	Set Aspiration Speed to 8. Hit small blue key to "Next."
Step 5	Set Dispensing Speed to 8. Hit small blue key to "End."

PRG Mode

Use for dispensing the following volumes: 200, 500, 700, 1000 μ ls from the 50-1,000 μ l pipette. Use for vessel 110 serum and 1% Ascorbic Acid for vessel 3.

Use for dispensing the following volumes: 50, 100 μ l's from the 5-100 μ l pipette. Use for vessel 3 whole blood and 7% Ascorbic Acid for vessel 110.

Programming – PRG	
Step 1	Select the pipetting mode “EDIT.” Turn the dial until the “EDIT” choice appears.
Step 2	Use rocker to highlight “New Program.”
Step 3	Press small blue key on left to “Select.”
Step 4	Use rocker to name programs (i.e., 200, 500, 700, 1000). Use rocker to find 1, then hit next, then find 0, next...
Step 5	Hit right small blue key to “Save.”
Step 6	Use rocker to highlight “Pipetting.”
Step 7	Use small blue key on left to “Edit.”
Step 8	Set Volume – use rocker to desired volume. Hit small blue key on left to “Next.”
Step 9	Set Aspiration Speed to 8. Hit small blue key on left to “Next.”
Step 10	Set Dispensing Speed to 8. Hit small right blue key to “Save.”
Step 11	Hit small right blue key to “Save.”
Step 12	Use rocker to highlight “New Program.”
Step 13	For remaining volumes, repeat steps 3–13.

Sequential Dispensing (SD) Mode

Use for the pooled serum profiles of age 12+ adults, 1- to 2-year-olds, 3- to 5-year-olds, and 6- to 11-year-olds from the 0.2-5 ml pipette.

Programming – SD	
Step 1	Select the selection dial to “EDIT.”
Step 2	Use the down arrow on the rocker to highlight program.
Step 3	Press the “Select” softkey.
Step 4	Highlight New Program and press the “select” softkey.
Step 5	You will be prompted to name the program. Use the rocker to select the character and the “Next” softkey to advance to the next space. Name this program “12 Up.”
Step 6	Press the “Save” softkey.
Step 7	Use the rocker to highlight “Sequential Dispensing” operating mode.
Step 8	Press the “Edit” softkey.
Step -9	Use the rocker to change the number of steps to 6.
Step 10	Press the “Next” softkey.
Step 11	Use the rocker to change the volume and assign the following volumes to the program: 0.7, 0.4, 0.9, 0.1, 1.0, 1.8 ml. Press “Next” after each volume.
Step 12	Press the “Next” softkey.
Step 13	Press the “Up” arrow on the rocker to change the aspiration speed to 8.
Step 14	Press the “Next” softkey.
Step 15	Press the “Up” arrow on the rocker to change the dispensing speed to 8.
Step 16	Press the “Save” softkey.
Step 17	Press the “Next” softkey and repeat steps 7-16 using the following steps and volumes: <ol style="list-style-type: none"> a. 8 steps 1.0, 0.5, 0.8, 0.5, 0.3, 1.0, 0.2, 0.5 ml

Programming – SD (continued)

Step 18	Press the “Next” softkey and repeat steps 7-16 using the following steps and volumes: a. 5 steps 0.6, 1.0, 1.0, 1.0, 1.0 ml
Step 19	Press the “Next” softkey and repeat steps 7-16 using the following steps and volumes: a. 5 steps 0.5, 0.5, 0.5, 0.5, 0.5 ml
Step 20	Press the “Save” softkey to save the program. The program will now appear in the program list.
Step 21	Set the selection dial to “Program” after all editing is complete.
Programming – SD 6- to 11-year-olds	
Step 1	Follow steps 1-4 in the 12 & Up procedure.
Step 2	You will be prompted to name the program. Use the rocker to select the character and the “Next” softkey to advance to the next space. Name this program “6-11.”
Step 3	Follow steps 6-16 in the “12 Up” programming instructions using the following steps and volumes: a. 7 steps b. 0.7, 0.9, 0.1, 1.0, 1.0, 0.5, 0.3 ml
Step 4	Press the “Next” softkey and repeat steps 7-16 in the “12 Up” program using the following steps and volumes: a. 4 steps b. 0.5, 0.5, 0.5, 0.5 ml
Step 5	Press the “Save” softkey to save the program. The program will now appear in the program list.
Step 6	Set the selection dial to “Program” after all editing is complete.
Programming – SD 3- to 5-year-olds	
Step 1	Follow steps 1-4 in the 12 & Up procedure.
Step 2	You will be prompted to name the program. Use the rocker to select the character and the “Next” softkey to advance to the next space. Name this program “3-5.”
Step 3	Follow steps 6-16 in the “12 Up” programming instructions using the following steps and volumes: a. 9 steps b. 0.7, 0.4, 0.3, 0.5, 0.5, 0.8, 0.3, 0.5, 0.5 ml
Step 4	Press the “Save” softkey to save the program, which will now appear in the program list.

Programming – SD 3- to 5-year-olds (continued)	
Step 5	Set the selection dial to “Program” after all editing is complete.
Programming – SD 1- to 2-year-olds	
Step 1	Follow steps 1-4 in the 12 & Up procedure.
Step 2	You will be prompted to name the program. Use the rocker to select the character and the “Next” softkey to advance to the next space. Name this program “1-2.”
Step 3	Follow steps 6-16 in the “12 Up” programming instructions using the following steps and volumes: <ol style="list-style-type: none"> a. 6 steps b. 0.7, 0.4, 0.3, 0.5, 0.3, 0.3 ml
Step 4	Press the “Save” softkey to save the program. The program will now appear in the program list.
Step 5	Set the selection dial to “Program” after all editing is complete.
Programming – SD Extras	
Step 1	Follow steps 1-4 in the 12 & Up procedure.
Step 2	You will be prompted to name the program. Use the rocker to select the character and the “Next” softkey to advance to the next space. Name this program “Extras.”
Step 3	Follow steps 6-16 in the “12 Up” programming instructions using the following steps and volumes: <ol style="list-style-type: none"> a. 8 steps b. 0.5, 0.5, 0.5, 0.5, 0.5, 0.5, 0.5, 0.5 ml
Step 4	Set the selection dial to “Program” after all editing is complete.

7.7.1.6 Mode of Operation – Pipetting for 5-100 μ l, 50-1,000 μ l & 0.2-5 ml Pipettes

If the display of the Xplorer Plus is dark, activate the pipette by pressing the toggle switch (up and down button). If the pipette has not been used for a long period, a motor reset is executed after it has been activated.

- Always pipette in the PRG or FIX mode. Turn dial to PRG or FIX.
- Attach an Eppendorf pipette tip to the Xplorer Plus. The color coded Actuate key corresponds to the color code of the racks for the pipette tips. The dispensing liquid is aspirated into the tip.

- When aspirating liquid, immerse the pipette tip vertically (about 4 mm) into the liquid.
- To wet the pipette tip, immerse the tip vertically, aspirate and dispense the liquid twice.
- To aspirate the liquid, press the rocker up. Maintain the immersion depth, to ensure no air is aspirated. Slowly pull the pipette tip out of the liquid. Wipe tip against the tube wall to ensure that no outer wetting remains on the pipette tip.
- Press the rocker down to dispense first drop only on the 0.2–5.0 pipettes. Pipette indicates this step needs to be down.
- To dispense the liquid, position the pipette tip at a slight angle against the side of the vessel, press the rocker down to dispense the liquid.
- After dispensing, press the rocker down again to trigger the blow-out.
- If more liquid is needed, reaspirate using same pipette tip and dispense per protocol.
- Discard the pipette tip by pressing the ejector, then attach a new tip and reaspirate liquid.

7.7.1.7 Care, Maintenance, and Ordering Information

The outside of the pipette can be wiped with a moist cloth. Using water with a wetting agent is also permitted.

DO NOT ALLOW ANY LIQUID TO ENTER THE PIPETTE.

Only the lower part of the pipette should be rinsed with distilled water and dried. The pipette may be wiped clean with 70% isopropanol.

If the pipette is very contaminated, or if very aggressive chemicals are dispensed, disassemble the lower half of the Xplorer Plus. Rinse the individual parts in distilled water and then dry them. Then lightly lubricate the piston, using silicone grease.

Only the lower half of the pipette can be disassembled. The individual parts of the lower part must be disassembled as separate pieces.

Removing the lower part – for pipettes $\leq 1,000 \mu\text{l}$:

1. Keep the ejector pressed and remove the ejector sleeve.
2. Push up on the ring marked “PUSH UP TO RELEASE” until the lower part comes off.
3. Remove the lower part from the upper part (Exhibit 7-18).

Exhibit 7-18. Removing the lower part –for pipettes $\leq 1,000 \mu\text{l}$

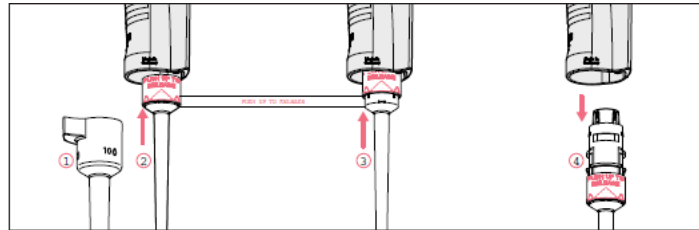

Opening the lower part for pipettes $\leq 1,000 \mu\text{l}$:

1. Slightly push the stop pins together on the piston mount (Exhibit 7-19).
2. Remove piston mount.
3. Remove the piston and the piston spring.

Exhibit 7-19. Opening the lower part –for pipettes $\leq 1,000 \mu\text{l}$

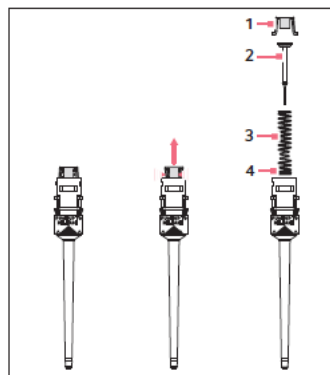

Installing the lower part and ejector sleeve for the $\leq 1,000 \mu\text{l}$:

1. Insert the lower part into the upper part until it audibly engages.
2. Set the maximum volume and move the rocker up and down several times.
3. Keep the ejector pressed.
4. Fit the ejector sleeve onto the ejector rod.

Removing the lower part for the 5 ml pipette (Exhibit 7-20):

The piston must be in its basic position before separating the lower and upper part. Press the rocker down to move the piston to its basic position.

1. Unscrew the ejector sleeve.
2. Keep the ejector pressed and turn the lower part 30° to the left or right. Pull the lower part down to cancel the magnetic coupling of the lower part.
3. Open the lower part – fit the pipette key into the lower part.
 - Hold the cylinder and unscrew it from the lower part.

Exhibit 7-20. Removing the lower part for the 5 ml pipette

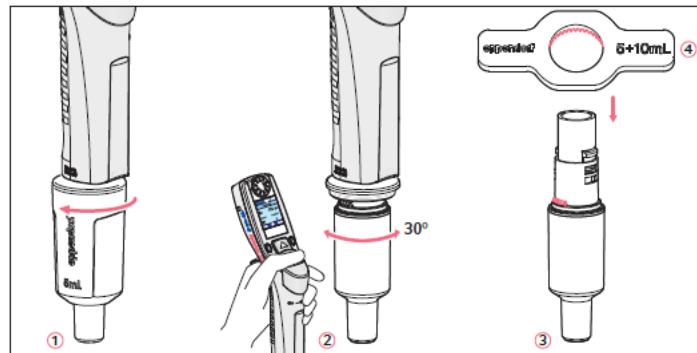

4. The upper part and the piston cannot be disassembled any further.

Reassemble the 5 ml pipette in reverse order. Make sure the magnet on the piston in the lower part is coupled with the magnet on the spindle in the upper part.

A complete list of troubleshooting information is included on pages 62-65 of the *Eppendorf Explorer Plus Manual*. Table 7-4 presents the Eppendorf pipette ordering information.

Table 7-4. Eppendorf pipette ordering Information

Item	Size	Part number
Eppendorf Xplorer Plus	5-100 μ l	4861000716
Eppendorf Xplorer Plus	50-1,000 μ l	4861000732
Eppendorf Xplorer Plus	0.2 – 5 ml	486000740
Charging carousel	Four Pipettes	4880
Pipette Tips		
Bulk-packaged, in bags	5-ml	2235-081-1
Eppendorf Biopur, colorless, sterile, pyrogen-free, DNA-free, Rnase-free In Boxes 5 x 96 = 480 tips	200 μ L	2249-002-8
Eppendorf Biopur, colorless, sterile, pyrogen-free, DNA-free, Rnase-free In Boxes 5 x 96 = 480 tips	1,000 μ L	2249-006-1
Additional accessories		
Spare rechargeable lithium ion battery, 1,200 mAh		

7.7.2 Process the 3-ml and 4-ml EDTA Tubes

The EDTA (tripotassium salts of ethylene diamine-tetracetic acid) acts as a chelating agent to combine with calcium in the blood to prevent coagulation. Use the well-mixed lavender 3-ml and 4-ml EDTA tubes for the hematology profile complete blood count (CBC) and certain whole blood tests. Use the 3- and/or 4-ml (age 12+) EDTA tubes for washed packed cells.

7.7.2.1 Process the 3-ml or 4-ml EDTA Tube for Lead/Cad/HG/Se/Mn, Cr/Co, RBC Folate, Glycohem, and Mercury

The hematology technologist runs the CBC on the room temperature 3-ml (age 1-11 years) or 4-ml (age 6+ years) EDTA tube after the blood-processing technologist verifies proper identification and labeling, and processes the tube for the Lead/Cad/HG/Se/Mn, RBC Folate, Glycohem, and Mercury. If the EDTA tube is clotted, do not process vessel 1 (Lead/Cad/HG/Se/Mn), vessel 216 (Cr/Co), vessel 3 (RBC Folate), vessel 4 (Glycohem), or vessel 5 (Mercury). If the CBC was

accidentally run before the whole blood for vessels 1 (Lead/Cad/HG/Se/Mn), vessel 216 (Cr/Co), and 5 (Mercury) was pipetted, do not process these three vessels and add the comment “laboratory error” to vessel 1, vessel 216, and vessel 5.

Complete the following process for all SPs. Use the following tubes for the CBC and whole blood protocol:

- Ages 1-2 years
 - Process the 3-ml EDTA tube for all whole blood tests and then run CBC.
- Ages 3-5 years
 - Process the first 3-ml EDTA tube for all whole blood tests and plasma test (vessel 155).
 - Process the 3-ml EDTA tube for CBC.
- Ages 6-11 years
 - Process the second 4-ml “Lavender 2” tube for all whole blood tests, plasma test (vessel 155) and the washed packed cells (vessel 88).
 - Process the first 4-ml “Lavender 1” tube for CBC.
- Ages 12-19 years
 - Process the first 4-ml “Lavender 1” tube for the CBC.
 - Process the second 4-ml “Lavender 2” tube for all whole blood tests and plasma (vessel 155) and washed packed cells (vessel 88).
- Ages 20+ years
 - Process the first 4-ml “Lavender 1” tube for the CBC.
 - Process the second 4-ml “Lavender 2” tube for all whole blood tests and the washed packed cells (vessel 88).
- Ages 40+ years
 - Process the first 4-ml “Lavender 1” tube for the CBC .
 - Process the second 4-ml “Lavender 2” tube for all whole blood tests.
 - Process the 3-ml EDTA tube for the washed packed cells (vessel 88).

The blood-processing technologist initially processes the 3- or 4-ml EDTA tube for the whole blood tests.

- Invert the appropriate EDTA tube several times to remix contents thoroughly.
- Pre-wet pipette tip.
- Refrigerate L-ascorbic acid diluent when not in use. Discard unused diluent at end of each session.

Vessel 1

- Use 3.5 ml disposable transfer pipette to aliquot 0.4 ml whole blood for vessel 1 (Lead/Cad/HG/Mn/Se) on primary SPs into a 2-ml sterile vessel.

Vessel 216

- Use 3.5 ml disposable transfer pipette to aliquot 1.0 ml whole blood from the **second** 4-ml EDTA tube drawn in phlebotomy for vessel 216 on primary SPs aged 40+ into a sterile 2-ml vessel. The label on the 4-ml EDTA tube will indicate Lavender 2, for the second lavender tube drawn in phlebotomy.

NOTE: If vessel 216 is part of SP's protocol, "Lavender 2" tube may be used for all the whole blood vessels of that SP.

Vessel 3

- Use Eppendorf pipette tips and the dedicated 5-100 μ l Eppendorf pipette to pipette 0.1 ml whole blood for vessel 3 (RBC Folate) on primary SPs into a 2-ml vessel.
- Pre-wet the pipette tips. Dilute the whole blood with ascorbic acid. Use trace metal free pipette tips and the dedicated 50-1,000 μ l Eppendorf pipette to immediately pipette 1.0 ml into the 1% ascorbic acid into the 2-ml vessel. Mix well.

Vessel 4

- Use 3.5 ml disposable transfer pipette to aliquot 0.4 ml whole blood for vessel 4 (Glycohem) on primary SPs aged 12+ into a 2-ml vessel.

Vessel 5

- Use 3.5 ml disposable transfer pipettes to aliquot 0.5 ml whole blood for vessel 5 (Mercury) on primary SPs into a 2-ml sterile vessel.
 - Securely close all vessels to prevent leakage and evaporation.
 - Record results using the Blood Processing module as described in Section 7.8.
 - Store all specimens immediately as outlined in Section 7.9.

Run the CBC within 2 hours. If unable to run the CBC within 2 hours, store the 3- or 4-ml EDTA blood tube at room temperature for no more than 24 hours. After 24 hours, the blood will undergo changes that will render the WBC, RBC, HgB, and HCT results inaccurate.

7.7.2.2 Process the 3- or 4-ml EDTA for Washed Packed Cells for Acrylamide (Vessel 88)

Centrifuge the EDTA tube and remove the plasma as described below. Leave the cells in the original blood collection tube. Wash the remaining red blood cells (erythrocytes) with sterile saline three times and then lyse the cells with distilled water. Store the saline in the refrigerator and use it cold. Pour saline and deionized water into squeeze bottles. It is acceptable to batch the samples as long as the samples and reagents are refrigerated.

Use the following tubes for the washed packed cells protocol for vessel 88:

- Process the cells from the 4-ml EDTA tube on SPs aged 6+ years. SPs aged 40+ will have an additional 3-ml EDTA tube drawn for packed cells processing.
 - Place the tube(s) in the centrifuge carrier of the refrigerated tabletop centrifuge. Balance the tube(s) in the centrifuge by using water-filled tubes if necessary. Take care not to disturb the pellet of red blood cells when removing the plasma.

Vessel 88

1. Centrifuge the 4-ml EDTA tube at 4-8°C. Centrifuge at 1,985 rpm for 5 minutes to separate the plasma from the cells.

2. Use a 3.5 ml disposable transfer pipette to remove the plasma, the upper clear layer, and add it to vessel 155, if vessel 155 is a part of that SP's protocol.
3. Use the refrigerated squeeze bottle of saline to add an equal amount (to the packed cells) of 0.9 percent cold saline to the packed cells.
4. Close vial and mix by gently shaking.
5. Centrifuge at 1,985 rpm and 4°C for 5 min.
6. Remove and discard the clear upper layer.
7. Repeat steps 3 to 6 two more times (total of 3 wash cycles).
8. After the last wash cycle, use the squeeze bottle of deionized water to add an equal amount of deionized water to the packed cells. (The final volume should be at least 1.0 ml of washed lysed packed cells.)
9. Close vial and mix by gently shaking.
10. Transfer the lysed cells to a 2-ml cryovial.
 - Close all vessels securely to prevent leakage and evaporation.
 - Record results using the Blood Processing module as described in Section 7.8.
 - Store all specimens immediately as outlined in Section 7.9.

7.7.3 Process the 2-ml Gray Tube for Glucose

Centrifuge and separate the plasma from the 2-ml gray top tube within 30 minutes from the time the blood was collected. Process the specimen even if the contents of the gray tube are clotted.

Refrigerate filled vessel 9 as soon as possible.

- Place the tube in the centrifuge carrier of either tabletop centrifuge. Balance the tube in the centrifuge by using water-filled tubes if necessary. Centrifuge the 2-ml gray tube at 4-8°C and 2,900 rpm for 10 minutes to yield plasma for vessel 9 (glucose).

Vessel 9 or 98

- Use a 3.5 ml disposable plastic transfer pipette to transfer all plasma from this tube but at least 0.5 ml plasma for vessel 9 (glucose) on primary SPs aged 12+ into a 2-ml vessel.
 - Determine if the plasma is hemolyzed, turbid, lipemic, or icteric. If so, enter a comment to describe the plasma when entering the processing results.

- Close all vessels securely to prevent leakage and evaporation.
- Record results using the Blood Processing module as described in Section 7.8.
- Store all specimens immediately as outlined in Section 7.9.

7.7.4 Process the 3-ml, 7-ml, 10-ml, and 15-ml Red Top for Pooled Sera

- Gently invert the tubes 5-6 times as soon as possible after receiving them in the laboratory.
- Place 3-ml, 7-ml, 10-ml, and 15-ml on the rocker for 10 minutes and then place in the rack to clot for the remaining time indicated on the timer.
- Allow the blood in each 3-ml, 7-ml, 10-ml, and 15-ml red top tubes to clot for 30-45 minutes at room temperature. Do not let clot for more than 1 hour.
- Place the tubes in either refrigerated tabletop centrifuge. Balance the tubes in the centrifuge by using water-filled tubes if necessary. Centrifuge the red top tubes at 4-8°C and 2,900 rpm for 15 minutes to yield serum.
- Determine if the serum is hemolyzed, turbid, lipemic, or icteric. If so, enter a comment to describe the serum when entering the processing results.

If the serum in any one red top tube from an SP is grossly hemolyzed, do not pool it with serum from the remaining tubes. Reserve it for the storage vessels 32-37.

If the serum in all red top tubes for a SP is turbid, lipemic, or icteric, pool it and allocate as usual.

Vessels 110, 138, 99, 70, 122, 87, 17, 21, 11, 77, 18, 23, 13, 22, 24, , 150, and 32-37.

- Use a serum separator to remove serum from all the red top tubes by pushing the separator to the clot barrier gently to ensure cell-free separation. Do not push the separator too hard. Do not touch it to the clot barrier.
- Label the 50-ml conical tube with SP ID #. Pool all clear sera. For each SP, pool the serum from all red top tubes by decanting the separated serum into the 50-ml conical tube. Hold the tube and the separator level while decanting the serum. Be careful to avoid introducing any cellular debris. Discard all tubes and separators in a sharps container.

- Securely close the 50-ml conical tube and mix its contents by gentle inversion. If there are any delays in processing, the conical tube should be placed in the refrigerator.
- Confirm that all vessels have the correct information with the appropriate SP's bar code ID label before filling them.
- Use the 200-5,000 Eppendorf pipette and 5-ml pipette tips to aliquot the serum for all vessels.
- Using clear serum only, fill as many vessels as possible in the priority order shown in Section 7.3. Exhibits 7-7 to 7-12 describe the order of allocation and specific procedures to follow for each person type and vessel.
- If excess serum remains after completing the entire protocol, add an additional 1.5 ml serum beginning with vessel 32 and continuing through vessel 37 until the serum is exhausted.
- Use Eppendorf pipette tips and the 200-5,000 μ l Eppendorf pipette to pipette 0.7 ml serum for vessel 110 (Folate1) on primary SPs aged 1+ into a 2-ml vessel. Pre-wet the pipette tips. Add the serum to 50 μ l of the 7% ascorbic acid pipetted in the vessel first, using trace metal free pipette tips and the 5-100 μ l Eppendorf pipette. Mix well.
 - Securely close all vessels to prevent leakage and evaporation.
 - Record results using the Blood Processing module as described in Section 7.8.
 - Store all specimens immediately as outlined in Section 7.9.
 - If the serum cannot be aliquoted immediately, refrigerate it at 4°C for no more than 4 hours.

Vessel 79

- Use the 5-100 μ l Eppendorf pipette to pipette 0.1 ml of serum for vessel 79 (Vitamin C) on primary SPs aged 6+ into a 2-ml vessel. Pre-wet the pipette tips. Dilute the serum by adding 400- μ L MPA solution to 0.1-ml or 100- μ L serum. Do not add the serum to the MPA; the MPA should be added to the serum. Mix vigorously for 15-20 seconds using a vortex.

7.7.5 Process the 15-ml Red Top Tubes for Environmental Subsamples

The environmental subsamples represent a one-third subsample of SPs aged 12+. SPs in the 0, 3, 7, 10 subsample group are eligible for vessels 29, 89, and 90. SPs in the 4, 6, 8, 9 subsample group are eligible for vessels 92 and 93.

- Place the tubes on the rocker as soon as possible after receiving them in the laboratory. Rock 10 minutes then allow to clot while sitting upright in a rack at room temperature 30–45 minutes, but no more than 60 minutes.
- Place the tubes in either refrigerated tabletop centrifuge. Balance the tubes in the centrifuge by using water-filled tubes if necessary. Centrifuge the red top tubes at 4–8°C and 2,900 rpm for 15 minutes to yield serum.

Vessels 29, 89, and 90

- Determine if the serum is hemolyzed, turbid, lipemic, or icteric. If so, enter a comment to describe the serum when entering the processing results.
- Use a serum separator to carefully remove serum from 2- 15-ml red top tubes by pushing the separator to the clot barrier gently to ensure cell-free separation. Do not push it too hard or some flow through may occur. Do not touch the separator to the clot barrier.
- Pool serum from the 2- 15-ml red top tubes into a 14-ml falcon, labeled with the SP ID #, and aliquot the serum immediately: 4.0 ml for vessel 29 (Dioxin 1) into a sterile 5-ml cryovial, 4.0 ml for vessel 89 (Dioxin 2) into a 5-ml sterile cryovial, and 1.5 ml into vessel 90 (Perfluor) into a sterile 2-ml cryovial on primary SPs aged 12+. Any extra serum should be distributed evenly between vessels 29 and 89.

Vessels 92 and 93

- Determine if the serum is hemolyzed, turbid, lipemic, or icteric. If so, enter a comment to describe the serum when entering the processing results.
- Use a serum separator to carefully remove serum from one 15-ml Red top tube by pushing the separator to the clot barrier gently to ensure cell-free separation. Do not push it too hard or some flow through may occur. Do not touch the separator to the clot barrier.

- Aliquot the serum immediately by pouring it into vessel 92 (BFR1) and vessel 93 (BRF2) on primary SPs aged 12+ into a 5-ml sterile cryovial, 3.0-ml required volume. Any extra serum should be distributed evenly between vessels 92 and 93.
 - Securely close all vessels to prevent leakage and evaporation.
 - Record results using the blood-processing module described in Section 7.8.
 - Store all specimens immediately as outlined in Section 7.9.

7.7.6 Ascorbic Acid Processing and Preparation

The CDC supplies premeasured 1 percent ascorbic acid (AA) for vessel 3 (RBC Folate) and a premeasured 7 percent AA solution for vessel 110 (Folate1). Prepare both reagents before processing the blood samples. Cover tubes with aluminum foil to protect the contents from light. Allow the reagent to equilibrate to room temperature before pipetting and performing the dilution. Use the Eppendorf Research pro pipettes to make the dilution. Add 1.0 ml of 1 percent ascorbic acid to 0.1 ml whole blood for vessel 3 (RBC Folate) and 0.05 ml of the 7 percent AA to vessel 110. Mix by gentle inversion.

- The 1 percent ascorbic acid powder is in a 50-ml Falcon tube. Dissolve the powder in 30 ml of deionized water using a graduated cylinder to measure the water and mix gently. Prepare this reagent **daily**. Date and label the Falcon tube. If the powder appears discolored or the solution appears cloudy, discard and prepare fresh reagent. If no bottled distilled water is available, use tap water. Record the reagent in the Daily QC Log each time it is prepared. The 7 percent AA powder is in a 2-ml Nalgene cryovial. Dissolve the powder in 2 ml of deionized water using a graduated cylinder to measure the water and mix gently. Prepare this reagent **daily**. Date and label the Nalgene tube. If the powder appears discolored or the solution appears cloudy, discard and prepare fresh reagent. If no bottled distilled water is available, use tap water. Record the reagent in the Daily QC Log each time it is prepared..
- Discard both the 1 percent and 7 percent AA prepared reagents at the end of each day and make fresh vials at the start of the next session.

7.7.7 Metaphosphoric Acid Preparation

The CDC provides pre-weighed metaphosphoric acid (MPA) for the Vitamin C assay. Prepare this reagent (6% MPA solution) weekly (7 days) before processing the blood samples. This is a strong acid; be very careful not to get it on the skin or in the eyes.

- The pre-weighed MPA crystals are supplied in glass vials. Transfer the crystals from the one glass vial into a clean 50-ml Falcon tube that has been appropriately labeled, including the date of preparation.
- Add exactly 50 ml of distilled water to the MPA crystals. It is acceptable to rinse the glass vial with a portion of the 50-ml distilled water and pour this into the 50-ml conical tube. It takes about 30 minutes for the crystals to go into solution. Mix gently every 10 minutes. It is acceptable to warm it by placing it between the hands while mixing it gently back and forth. Record the reagent in the QC log each time it is prepared.
- Store this reagent refrigerated when not in use.
- At the start of each exam day, transfer 8 ml of the MPA reagent from the 50-ml Falcon tube to a 14-ml Falcon snap cap tube. Keep the remainder of the solution in the 50-ml Falcon tube refrigerated. At the end of each exam day, discard any remaining MPA in the 14-ml Falcon snap cap tube. Always allow the MPA reagent to warm to room temperature before dispensing.
- To prepare diluted serum samples for the Vitamin C assay, allow the MPA reagent to equilibrate to room temperature before using it to dilute serum samples.

7.8 Record the Results of Specimen Processing

After filling or processing the whole blood, plasma, serum, and/or the EDTA or gray top tubes for each SP, use the Blood Processing module to enter the blood processing results.

Open and log onto the Laboratory application. Use the heads-up display to view the SPs, the modules for which they are eligible, and their current process status.

Select the correct SP and access the Blood Processing module.

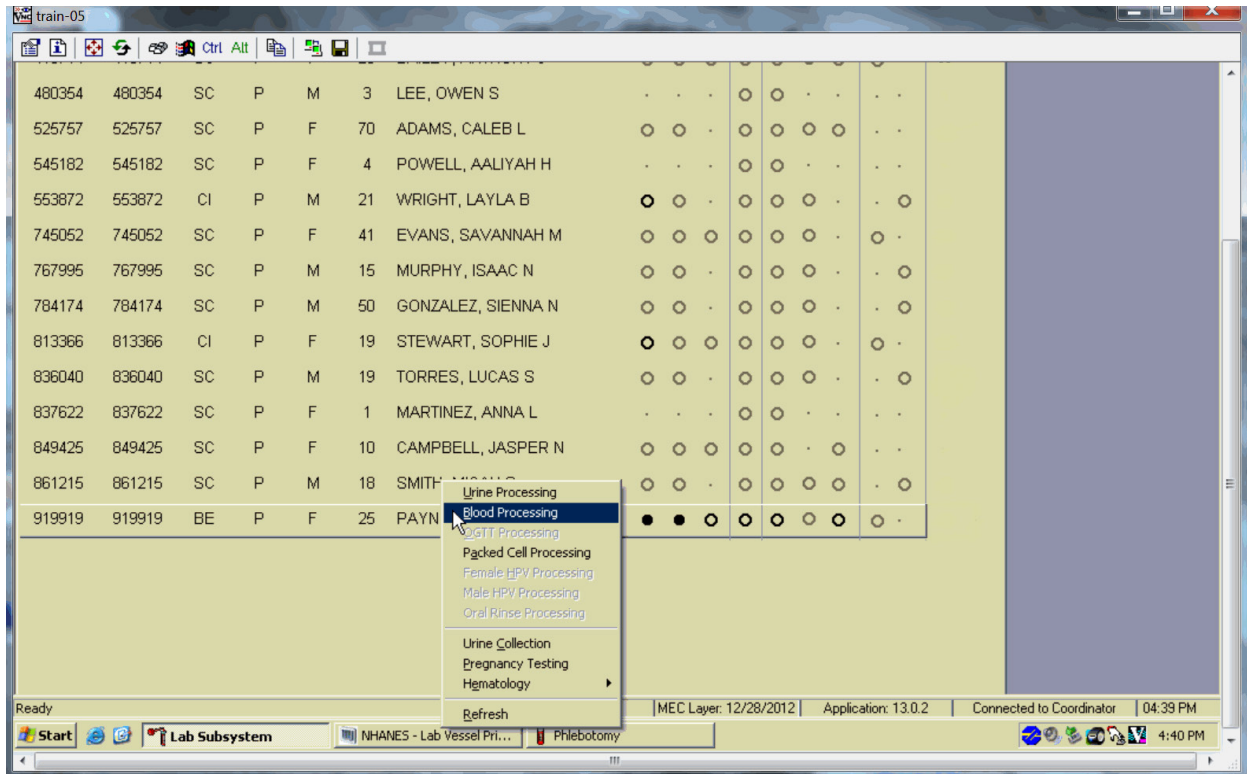

If labels have not been printed in advance, the SPs will show up in a red font on the heads-up display. To access the Blood Processing module, highlight the SP, right-click, drag the mouse arrow to Blood Processing.

The SP's blood processing screen displays.

The screenshot shows a software window titled "train-05" with a sub-window "BP: 919919" and "B processing". The patient information is as follows:

Tech ID: 1756	Sample ID: 919919	Name: PAYNE, IMA L	Gender: F	Age: 25
	SP ID: 919919	Appt Type: Primary	Fasting Req: Morning - Fast	

Below the patient information is a table of vessels:

Vessel ID	Test Name	CAP	Sample Volume	Type	Vessel Volume	Vessel Name	Filled	Comments	Container ID	Slot#
54	VOC Blood		7.0	WW	7 ml	gray top	<input type="radio"/> Yes <input type="radio"/> No			
1	PbCdHgSeMn		0.4	W	2 ml	Nalge Cryovial	<input type="radio"/> Yes <input type="radio"/> No			
3	RBC Folate		0.1	W	2 ml	Nalge Cryovial	<input type="radio"/> Yes <input type="radio"/> No			
4	Glycohem		0.4	W	2 ml	Nalge Cryovial	<input type="radio"/> Yes <input type="radio"/> No			
5	Mercury		0.5	W	2 ml	Nalge Cryovial	<input type="radio"/> Yes <input type="radio"/> No			
9	Glucose		0.5	P	2 ml	Nalge Cryovial	<input type="radio"/> Yes <input type="radio"/> No			
110	Folate 1		0.7	S	2 ml	Nalge Cryovial	<input type="radio"/> Yes <input type="radio"/> No			
138	CMV		0.4	S	2 ml	Nalge Cryovial	<input type="radio"/> Yes <input type="radio"/> No			
122	Hep profile		1.0	S	2 ml	Nalge Cryovial	<input type="radio"/> Yes <input type="radio"/> No			
17	Cotinine		1.8	S	2 ml	Nalge Cryovial	<input type="radio"/> Yes <input type="radio"/> No			
21	Lipids		1.0	S	2 ml	Nalge Cryovial	<input type="radio"/> Yes <input type="radio"/> No			
77	HPV Serum		0.5	S	2 ml	Nalge Cryovial	<input type="radio"/> Yes <input type="radio"/> No			

At the bottom of the window are buttons for "Save", "Phlebotomy", "OK", and "Cancel".

The blood processing window for an SP contains the following information: Tech ID, Sample ID, SP ID, Name (last, first), Gender, Age, Appt (appointment) Type, Fasting Req, columns for Vessel ID, Test Name, Sample Volume, Type (whole blood, plasma, serum), Vessel Volume, Vessel Name, Filled radio buttons, Comments text box, and a Container ID/Slot# column. Vessels that require sterile 2-ml cryovials are displayed in blue.

Inspect the SP's Vacutainer® tubes. Compare the Sample ID on the tubes to the bar code label on the vessels. Verify that the number of tubes and the recorded amount of blood collected are correct.

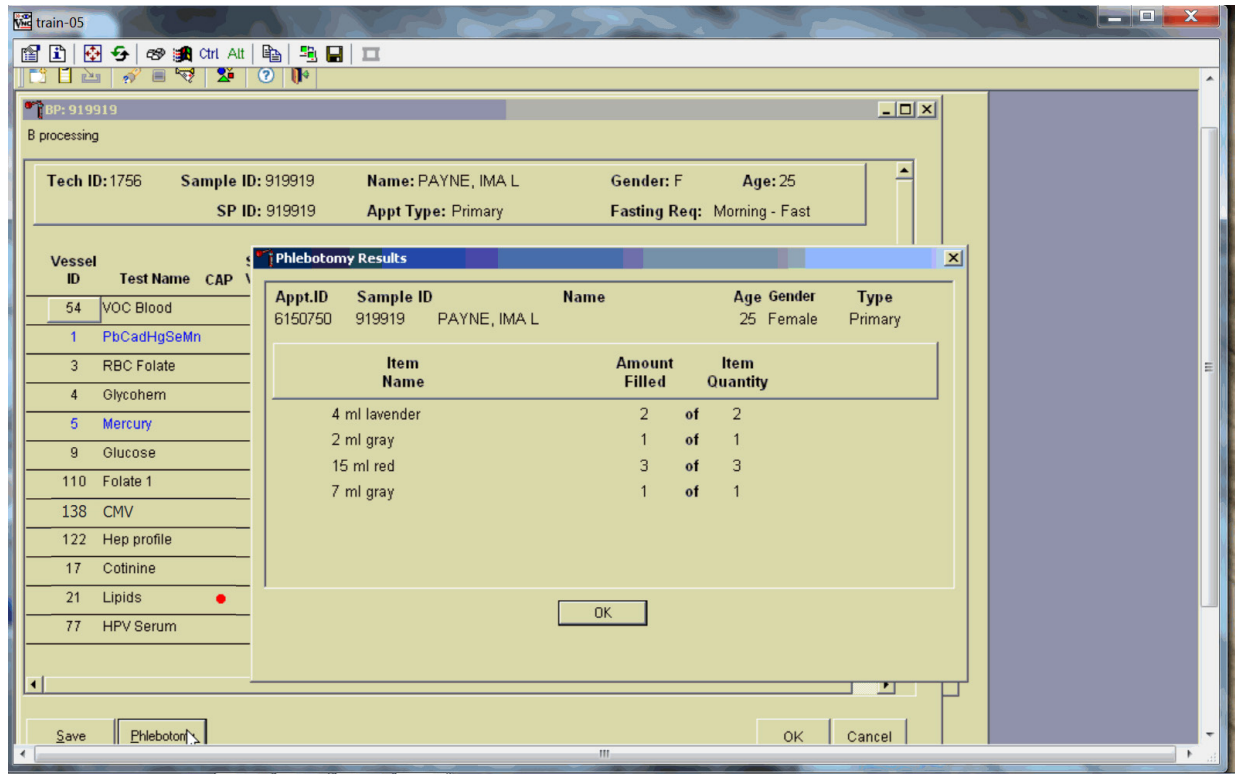

To review the phlebotomy results, use the mouse to direct the mouse arrow to the Phlebotomy button on the blood processing screen and left-click. The phlebotomy protocol and number of tubes successfully collected displays. To close this screen, use the mouse to direct the mouse arrow to the OK button and left-click.

Record blood processing results for each SP. Individually mark each vessel as Filled–Yes.

BP: 919919
B processing

Tech ID: 1756 Sample ID: 919919 Name: PAYNE, IMA L Gender: F Age: 25
 SP ID: 919919 Appt Type: Primary Fasting Req: Morning - Fast

Vessel ID	Test Name	CAP	Sample Volume	Type	Vessel Volume	Vessel Name	Filled	Comments	Container ID	Slot#
54	VOC Blood		7.0	WW	7 ml	gray top	<input checked="" type="radio"/> Yes <input type="radio"/> No	(none)	0615343	2
1	PbCadHgSeMn		0.4	W	2 ml	Nalge Cryovial	<input checked="" type="radio"/> Yes <input type="radio"/> No	(none)	0615328	5
3	RBC Folate		0.1	W	2 ml	Nalge Cryovial	<input checked="" type="radio"/> Yes <input type="radio"/> No	(none)	0615329	4
4	Glycohem		0.4	W	2 ml	Nalge Cryovial	<input type="radio"/> Yes <input type="radio"/> No			
5	Mercury		0.5	W	2 ml	Nalge Cryovial	<input type="radio"/> Yes <input type="radio"/> No			
9	Glucose		0.5	P	2 ml	Nalge Cryovial	<input type="radio"/> Yes <input type="radio"/> No			
110	Folate 1		1.0	S	2 ml	Nalge Cryovial	<input type="radio"/> Yes <input type="radio"/> No			
122	Hep profile		1.0	S	2 ml	Nalge Cryovial	<input type="radio"/> Yes <input type="radio"/> No			
17	Cotinine		1.8	S	2 ml	Nalge Cryovial	<input type="radio"/> Yes <input type="radio"/> No			
21	Lipids		1.0	S	2 ml	Nalge Cryovial	<input type="radio"/> Yes <input type="radio"/> No			
77	HPV Serum		0.5	S	2 ml	Nalge Cryovial	<input type="radio"/> Yes <input type="radio"/> No			

Save Phlebotomy OK Cancel

To mark an individual blood vessel as collected or Filled–Yes, use the mouse to direct the mouse arrow to the center of the “Yes” radio button and left-click. As each vessel is marked as Filled–Yes, it is automatically assigned to a slot in an existing (open) container.

Individually mark each vessel as Filled–No.

BP: 919919
B processing

Tech ID: 1756 Sample ID: 919919 Name: PAYNE, IMA L Gender: F Age: 25
 SP ID: 919919 Appt Type: Primary Fasting Req: Morning - Fast

Vessel ID	Test Name	CAP	Sample Volume	Type	Vessel Volume	Vessel Name	Filled	Comments	Container ID	Slot#
54	VOC Blood		7.0	WW	7 ml	gray top	<input checked="" type="radio"/> Yes <input type="radio"/> No	(none)	0615343	2
1	PbCadHgSeMn		0.4	W	2 ml	Nalge Cryovial	<input checked="" type="radio"/> Yes <input type="radio"/> No	(none)	0615328	5
3	RBC Folate		0.1	W	2 ml	Nalge Cryovial	<input checked="" type="radio"/> Yes <input type="radio"/> No	(none)	0615329	4
4	Glycohem		0.4	W	2 ml	Nalge Cryovial	<input type="radio"/> Yes <input type="radio"/> No	(none)		
5	Mercury		0.5	W	2 ml	Nalge Cryovial	<input type="radio"/> Yes <input type="radio"/> No	(none)		
9	Glucose		0.5	P	2 ml	Nalge Cryovial	<input type="radio"/> Yes <input checked="" type="radio"/> No	(none)		

To mark an individual blood vessel as not collected or Filled–No, use the mouse to direct the mouse arrow to the center of the “No” radio button and left click. Vessels marked as “No” require a comment.

Collectively mark all vessels as Filled–Yes.

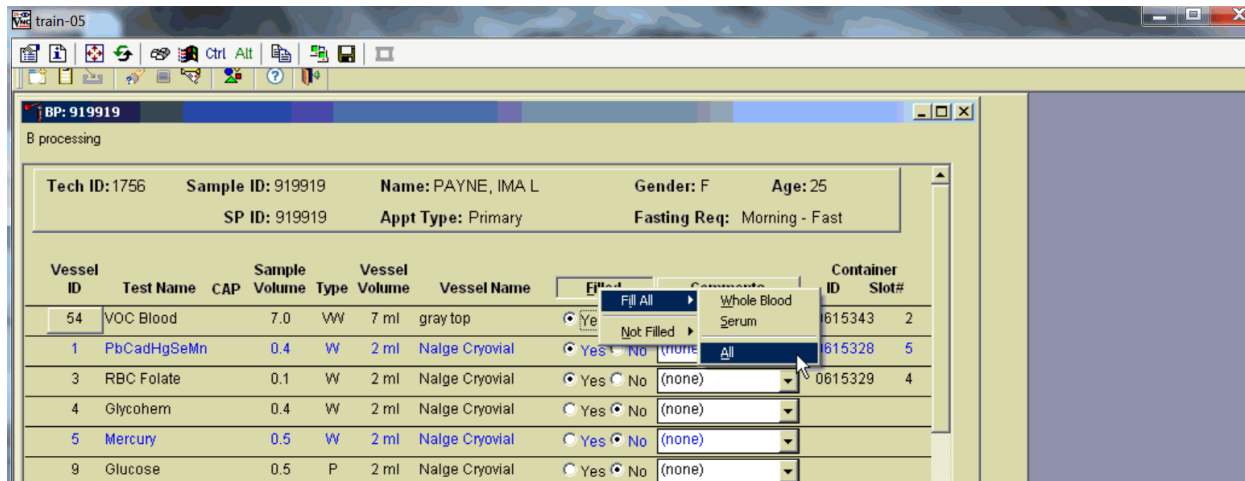

To collectively mark all vessels as Filled–Yes, use the mouse to direct the mouse arrow to the Filled button on the top of the radio buttons, left-click, drag the arrow to Fill All, drag the mouse arrow to {All}, and left-click. Selectively mark all whole blood or serum vessels as Filled–Yes.

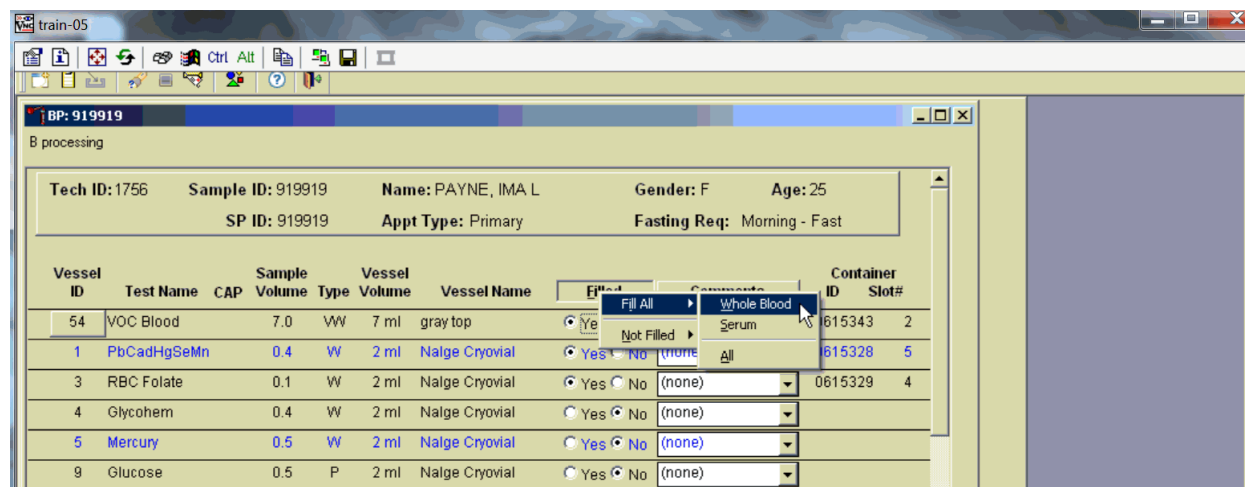

To collectively mark all whole blood vessels as Filled–Yes, use the mouse to direct the mouse arrow to the “Filled” button on the top of the radio buttons, left-click, drag the arrow to Fill All, drag the mouse arrow to Whole Blood, and left-click. To collectively mark all serum vessels as Filled–Yes,

direct the mouse arrow to the Filled button on the top of the radio buttons, left-click, drag the arrow to Fill All, drag the mouse arrow to Serum, and left-click. As each vessel is marked as Filled, it is automatically assigned to a slot in an existing (open) container.

Quality comment codes are available to describe the quality of the specimen (Exhibit 7-21).

Exhibit 7-21. Quality comment codes

Comment for filled vessels	Use when:
Clotted	The whole blood sample contains a fibrin formation. This is due to inadequate mixing or inadequate clotting.
Equipment failure	Pipettes are malfunctioning.
Hemolyzed	There is a red appearance to the serum or plasma. "Hemolysis" refers to the abnormal lysis of erythrocytes. Hemolysis can occur before venipuncture (<i>in vivo</i> hemolysis) or during the analytic procedure (<i>in vitro</i> hemolysis). If <i>in vivo</i> , hemolysis will give plasma a red color. Use when describing visible hemolysis, which occurs when the concentration of hemoglobin exceeds 200 mg/L.
Icteric	There is visible orange color to the serum or plasma. "Icteric" refers to orange color imparted to a sample because of the presence of bilirubin. Bilirubin present in serum results in a visible "jaundice" color when the concentration of bilirubin is above 430 umol/L.
Lipemic	There is turbid appearance to the serum or plasma. "Lipemia" refers to the presence of lipid particles (usually very low-density lipoprotein) in a sample, which gives the sample a turbid appearance. Plasma appears visibly lactescent or lipemic when the concentration of triglycerides exceeds 4.6 mmol/L.

Attach a comment to an individual filled vessel.

The screenshot shows a software window titled "train-05" with a menu bar containing "Ctrl Alt" and other icons. Below the menu bar, there is a header area with the following information:

BP: 919919
B processing

Tech ID: 1756 Sample ID: 919919 Name: PAYNE, IMA L Gender: F Age: 25
SP ID: 919919 Appt Type: Primary Fasting Req: Morning - Fast

Below this is a table with the following columns: Vessel ID, Test Name, CAP, Sample Volume, Type, Vessel Volume, Vessel Name, Filled, Comments, Container ID, and Slot#. The table contains several rows, with the second row (Vessel ID 1) selected. A dropdown menu is open under the "Comments" column for this row, showing a list of options: (none), 0.5 mL of serum used instead of 0.7 mL, clotted, equipment failure, hemolyzed, icteric, and lipemic.

Vessel ID	Test Name	CAP	Sample Volume	Type	Vessel Volume	Vessel Name	Filled	Comments	Container ID	Slot#
54	VOC Blood		7.0	WW	7 ml	gray top	<input checked="" type="radio"/> Yes <input type="radio"/> No	(none)	0615343	2
1	PbCadHgSeMn		0.4	W	2 ml	Nalge Cryovial	<input checked="" type="radio"/> Yes <input type="radio"/> No	(none)	0615328	5
3	RBC Folate		0.1	W	2 ml	Nalge Cryovial	<input checked="" type="radio"/> Yes <input type="radio"/> No	(none)		
4	Glycohem		0.4	W	2 ml	Nalge Cryovial	<input type="radio"/> Yes <input checked="" type="radio"/> No	0.5 mL of serum used instead of 0.7 mL		
5	Mercury		0.5	W	2 ml	Nalge Cryovial	<input type="radio"/> Yes <input checked="" type="radio"/> No	clotted		
9	Glucose		0.5	P	2 ml	Nalge Cryovial	<input type="radio"/> Yes <input checked="" type="radio"/> No	equipment failure		
110	Folate 1		0.7	S	2 ml	Nalge Cryovial	<input type="radio"/> Yes <input checked="" type="radio"/> No	hemolyzed		
122	Hep profile		1.0	S	2 ml	Nalge Cryovial	<input type="radio"/> Yes <input checked="" type="radio"/> No	icteric		
17	Cotinine		1.8	S	2 ml	Nalge Cryovial	<input type="radio"/> Yes <input checked="" type="radio"/> No	lipemic		

To attach a quality control comment to an individual filled vessel, direct the mouse arrow to the drop-down list under the Comments button to display the choices, drag the arrow to the correct choice, left-click.

Use the following procedure when all filled vessels require the same comment.

BP: 919919
B processing

Tech ID: 1756 Sample ID: 919919 Name: PAYNE, IMA L Gender: F Age: 25
 SP ID: 919919 Appt Type: Primary Fasting Req: Morning - Fast

Vessel ID	Test Name	CAP	Sample Volume	Type	Vessel Volume	Vessel Name	Filled	Comments	Container
54	VOC Blood		7.0	WW	7 ml	gray top	<input checked="" type="radio"/> Yes <input type="radio"/> No	(none)	
1	PbCadHgSeMn		0.4	W	2 ml	Nalge Cryovial	<input checked="" type="radio"/> Yes <input type="radio"/> No	(none)	0815328 5
3	RBC Folate		0.1	W	2 ml	Nalge Cryovial	<input checked="" type="radio"/> Yes <input type="radio"/> No	(none)	0615329 4
4	Glycohem		0.4	W	2 ml	Nalge Cryovial	<input type="radio"/> Yes <input checked="" type="radio"/> No	(none)	
5	Mercury		0.5	W	2 ml	Nalge Cryovial	<input type="radio"/> Yes <input checked="" type="radio"/> No	(none)	
9	Glucose		0.5	P	2 ml	Nalge Cryovial	<input type="radio"/> Yes <input checked="" type="radio"/> No	(none)	

Comments dropdown menu options: icteric, lipemic, equipment failure, clotted, hemolyzed, (none)

To collectively assign the same comment to all vessels, use the mouse to direct the mouse arrow to the Comments button on the top of the radio buttons, left-click, drag the arrow to Filled Comments, drag the mouse arrow to the correct choice, and left-click. All blood tubes (vessel 54) must be marked individually.

All vessels marked as Filled–No require a comment or explanation.

Enter comment codes to describe the reasons why a vessel is marked as Filled–No, or why the protocol is incomplete (Exhibit 7-22).

Exhibit 7-22 Comments for not filled vessels

Comment for not filled vessels	Use when:
Laboratory error	A tube breaks in the centrifuge, contents spill, or other technologist error.
Quantity not sufficient	Quantity of blood is not sufficient to complete the protocol.
SP refusal	The SP does not provide consent and is, consequently, excluded from HIV.

Attach a comment to an individual Filled–No vessel.

The screenshot shows a software interface with a table of vessels. The table has columns for 'Filled' status, 'Comments', 'Container ID', and 'Slot#'. The 'Filled' column has radio buttons for 'Yes' and 'No'. The 'Comments' column has a dropdown menu. The 'Container ID' and 'Slot#' columns contain numerical values. A dropdown menu is open for the fourth vessel, showing options: '(none)', 'laboratory error', 'quantity not sufficient', and 'SP refusal'. The 'laboratory error' option is highlighted. At the bottom of the interface, there are 'OK' and 'Cancel' buttons.

Filled	Comments	Container ID	Slot#
<input checked="" type="radio"/> Yes <input type="radio"/> No	(none)	0615343	2
<input checked="" type="radio"/> Yes <input type="radio"/> No	(none)	0615328	5
<input checked="" type="radio"/> Yes <input type="radio"/> No	(none)	0615329	4
<input type="radio"/> Yes <input checked="" type="radio"/> No	(none)		
<input type="radio"/> Yes <input checked="" type="radio"/> No	laboratory error		
<input type="radio"/> Yes <input type="radio"/> No	quantity not sufficient		
<input type="radio"/> Yes <input type="radio"/> No	SP refusal		
<input type="radio"/> Yes <input type="radio"/> No			
<input type="radio"/> Yes <input type="radio"/> No			
<input type="radio"/> Yes <input type="radio"/> No			
<input type="radio"/> Yes <input type="radio"/> No			

To attach a Filled–No comment to an individual vessel, use the mouse to direct the mouse arrow to the drop-down list under the Comments button to display the choices, drag the arrow to the correct choice, and left-click.

Use the following procedure when all Filled–No vessels require the same comment.

The screenshot shows a software interface with a table of vessels. The table has columns for 'Filled', 'Comment', and 'Container'. The 'Filled' column contains radio buttons for 'Yes' and 'No'. The 'Comment' column contains dropdown menus, many of which are set to '(none)'. The 'Container' column contains text like '0615328' and '4'. A mouse cursor is hovering over the 'Filled' column header, and a context menu is open, showing options like 'laboratory error', 'SP refusal', and 'quantity not sufficient'. The context menu also has a '(none)' option. At the bottom of the interface, there are 'OK' and 'Cancel' buttons.

To collectively attach the same comment to all Filled–No vessels, use the mouse to direct the mouse arrow to the Filled button on the top of the radio buttons, left-click, drag the arrow to {Not Filled All}, drag the mouse arrow to the desired choice, and left-click.

If the EDTA tube is clotted, do not process vessel 1 (Lead/Cad), vessel 216 (Cr/Co), vessel 3 (RBC Folate), vessel 4 (Glycohem), or vessel 5 (Mercury).

Attach the “Laboratory error” comment to a Filled–No result for vessels 1 and 5, if the CBC was run before the vessels were processed.

Vessel ID	Test Name	CAP	Sample Volume	Vessel Type	Vessel Volume	Vessel Name	Filled	Comments	Container ID	Slot#
54	VOC Blood		7.0	WW	7 ml	gray top	<input checked="" type="radio"/> Yes <input type="radio"/> No	(none)	0615343	2
1	PbCadHgSeMn		0.4	W	2 ml	Nalge Cryovial	<input checked="" type="radio"/> Yes <input type="radio"/> No	(none)	0615328	5
3	RBC Folate		0.1	W	2 ml	Nalge Cryovial	<input checked="" type="radio"/> Yes <input type="radio"/> No	(none)	0615329	4
4	Glycohem		0.4	W	2 ml	Nalge Cryovial	<input type="radio"/> Yes <input checked="" type="radio"/> No	(none)		
5	Mercury		0.5	W	2 ml	Nalge Cryovial	<input type="radio"/> Yes <input checked="" type="radio"/> No	laboratory error		
9	Glucose		0.5	P	2 ml	Nalge Cryovial	<input type="radio"/> Yes <input checked="" type="radio"/> No	(none)		

If the CBC was accidentally run before the whole blood for vessels 1 (Lead/Cad), vessel 216 (Cr/Co), and 5 (Mercury) were pipetted, do not process these three vessels. Mark vessel 1, vessel 216 (Cr/Co), and 5 as Filled–No and attach the comment “laboratory error.” Continue to pipette the whole blood for vessels 3 and 4 even if the CBC was run before the whole blood was pipetted.

Continue to enter results as vessels are processed. Review the information in the blood processing window and save the data to the database.

Filled		Comments	Container ID	Slot#
<input checked="" type="radio"/> Yes <input type="radio"/> No		(none)	0615343	2
<input checked="" type="radio"/> Yes <input type="radio"/> No		(none)	0615328	5
<input checked="" type="radio"/> Yes <input type="radio"/> No		(none)	0615329	4
<input checked="" type="radio"/> Yes <input type="radio"/> No		(none)	0615330	4
<input checked="" type="radio"/> Yes <input type="radio"/> No		(none)	0615331	3
<input checked="" type="radio"/> Yes <input type="radio"/> No		(none)	0615332	5
<input checked="" type="radio"/> Yes <input type="radio"/> No		(none)	0615355	3
<input checked="" type="radio"/> Yes <input type="radio"/> No		(none)	0615351	4
<input checked="" type="radio"/> Yes <input type="radio"/> No		(none)	0615345	4
<input checked="" type="radio"/> Yes <input type="radio"/> No		(none)	0615352	4
<input checked="" type="radio"/> Yes <input type="radio"/> No		(none)	0615334	4
<input checked="" type="radio"/> Yes <input type="radio"/> No		(none)	0615336	6
<input checked="" type="radio"/> Yes <input type="radio"/> No		(none)	0615346	2

Store each filled vessel in the assigned slot in the assigned container. To record this action or to save the data to the database, use the mouse to direct the mouse arrow to the Save button and left-click. To record this action or to save the data to the database and exit the module, use the mouse to direct the mouse arrow to the OK button and left-click. To close the window without saving any data in the database, use the mouse to direct the mouse arrow to the Cancel button and left-click.

7.9 Blood Specimen Storage

7.9.1 Blood Specimen Storage Protocol

Fill the blood vessels, enter the blood processing results, and prepare to store the vessels. Store vessels in numbered storage boxes according to test as indicated in Exhibit 7-23.

At the beginning of each stand, generate and print a series of bar-coded, numbered labels for storage containers as described in Chapter 8. Use the shipping module to assign a bar code label to a specific storage container (test). This process “opens” a storage box. Each vessel is assigned to a specific slot in a specific container as processing results are entered. Slots in containers are assigned according to a standard left to right, top to bottom procedure. Store each vessel in the appropriate slot in the correct container immediately after processing.

Exhibit 7-23. Storage protocol for blood

Shipping location	Vessels	Conditions	Vessel storage	Ship frequency
CDC/NCEH Air Toxicant Branch	54 VOC Blood	Refrigerated	5 x 5 five-inch foam box	Weekly
CASPIR	1 Lead/Cad/HG/ Se/Mn	Frozen	9 x 9 two-inch box	Weekly
CDC/NCEH Inorganic Toxicology Laboratory	216 Cr/Co	Frozen	9 x 9 two-inch box	Weekly
CASPIR	3 RBC Folate	Frozen	10 x 10 two-inch box	Weekly
University of Missouri	4 Glycohem	Refrigerated	9 x 9 two-inch box	Weekly
CASPIR	5 Mercury, Ethyl & Methyl	Frozen	9 x 9 two-inch box	Weekly
CASPIR	88 Acrylamide	Frozen	9 x 9 two-inch box	Weekly
University of Missouri	9 Glucose	Frozen	9 x 9 two-inch box	Weekly
CASPIR	110 Folate	Frozen	10 x 10 two-inch box	Weekly
CDC/NCIRD CMV Diagnostic Laboratory	138 CMV	Frozen	9 x 9 two-inch box	Weekly
CASPIR	99 Ferritin/Transferrin Receptor	Frozen	9 x 9 two-inch box	Weekly
CASPIR	70 Vitamin A, D, E, & Carotenoids	Frozen	10 x 10 two-inch box	Weekly
CASPIR	79 Vitamin C	Frozen	9 x 9 two-inch box	Weekly
CDC/NCID Hepatitis Ref Lab	122 Hep Profile	Frozen	9 x 9 two-inch box	Weekly
CDC/NCID Hepatitis Ref Lab	87 Hepatitis ab	Frozen	9 x 9 two-inch box	Weekly
CASPIR	17 Cotinine	Frozen	9 x 9 two-inch box	Weekly
University of Minnesota	21 Lipids	Frozen	9 x 9 two-inch box	Weekly
University of Minnesota	11 Iron/TIBC/% Saturation	Frozen	9 x 9 two-inch box	Weekly

Exhibit 7-23. Storage protocol for blood (continued)

Shipping location	Vessels	Conditions	Vessel storage	Ship frequency
University of Minnesota	18 Biochem	Refrigerated	9 x 9 two-inch box	Weekly
University of Missouri	23 Insulin	Frozen	9 x 9 two-inch box	Weekly
University of Minnesota	13 CRP	Frozen	9 x 9 two-inch box	Weekly
CDC NCID AIDS Division	22 HIV	Frozen	9 x 9 two-inch box	Weekly
Emory University	24 HSV	Frozen	9 x 9 two-inch box	Weekly
CDC/DVRD HPV	77 HPV Serum	Frozen	9 x 9 two-inch box	End of stand
CASPIR	150 Aldehyde	Refrigerated	9 x 9 two-inch box	Weekly
CASPIR	32-37 Xtra Sera	Frozen	9 x 9 two-inch box	End of stand
CASPIR	29 Dioxin 1 89 Dioxin 2	Frozen	9 x 9 three-inch box	End of stand
CASPIR	90 Perfluor	Frozen	9 x 9 two-inch box	End of stand
CASPIR	92 BFR 1 93 BFR 2	Frozen	9 x 9 three-inch box	End of stand

7.10 How to Deal With System Failure

If the computer system fails, record results on a preprinted workstation 2 processing worksheet (Exhibit 7-24). Complete a Blood Processing worksheet for each SP while processing the blood specimens. Enter the results after the system is operational.

Exhibit 7-24. Workstation 2 processing worksheet

BLOOD PROCESSING

SP ID _____

ID	Name	Ages	Sample ml	Sample type	Filled ✓	Filled Comments		Slot #
						<i>Icteric</i> <i>Lipemic</i> <i>Equip Failure</i> <i>Clotted</i> <i>Hemolyzed</i>	Not Filled Comments <i>QNS SP</i> <i>Refusal Lab</i> <i>Error</i>	
54	VOC Blood	12+	10.0	WB				
1	Lead/Cad/HG/ Se/Mn	1+	0.4	WB				
216	Co/Cr	40+	1.0	WB				
3	RBC Folate	1+	0.1	WB				
4	Glycohem	12+	0.4	WB				
5	Mercury, Ethyl, & Methyl	1+	0.5	WB				
88	Acrylamide	6+	1.0	PC				
9	Glucose	12+	0.5	P				
110	Folate	1+	0.7	S				
138	CMV	1-5	0.4	S				
99	Ferritin/Tfr	1-5	0.3	S				
		12-49	0.4					
70	Vitamin A, D, E, & Carotenoids	1-5	0.5	S				
		6+	0.9					
122	Hep Profile	6+	1.0	S				
87	Hepatitis Bs Ab	2	0.3	S				
		3-5	0.5					

Exhibit 7-24. Workstation 2 processing worksheet (continued)

BLOOD PROCESSING

SP ID _____

ID	Name	Ages	Sample ml	Sample Type	Filled ✓	Filled Comments		Slot #
						<i>Icteric</i> <i>Lipemic</i> <i>Equip Failure</i> <i>Clotted</i> <i>Hemolyzed</i>	Not Filled Comments <i>QNS SP</i> <i>Refusal Lab Error</i>	
17	Cotinine	3-5	0.8	S				
		6-11	1.0					
		12+	1.8					
21	Lipids	6-11	0.5	S				
		12+	1.0					
11	Iron/TIBC/% Saturation	12+	0.5	S				
18	Biochem	12+	0.8	S				
23	Insulin	12+	0.5	S				
13	CRP	1+	0.3	S				
22	HIV	18-59	1.0	S				
24	HSV	14-49	0.2	S				
77	HPV Serum	14-59	0.5	S				
150	Aldehyde	6+	0.6	S				
32	Xtra Sera1	3+	0.5	S				
33	Xtra Sera2	3+	0.5	S				
34	Xtra Sera3	12+	1.0	S				
35	Xtra Sera4	12+	1.0	S				
36	Xtra Sera5	12+	1.0	S				
37	Xtra Sera6	12+	1.0	S				
29	Dioxin1	12+	4.0	S				
89	Dioxin 2	12+	4.0	S				
90	Perfluor1	12+	1.5	S				
92	BFR1	12+	4.0	S				
93	BFR2	12+	4.0	S				

WB = Whole blood
P = Plasma
PC = Packed cells
S = Serum

Printing Labels and Specimen Shipment

8

8.1 Introduction

Labels are essential to the laboratory component. Labels support each study participant's (SP's) unique processing protocol. The laboratory record is created when the medical technologist opens a session for the first time. This record forms the basis for each SP's data in the database. Container labels are generated and assigned to vessel storage containers and allow a processed sample to be tracked from mobile examination center (MEC) processing through contract laboratory receipt.

Biological specimens are shipped to a variety of contract laboratories in double-sided Styrofoam and corrugated cardboard shippers or hard-sided shippers with Styrofoam inserts using dry ice or wet ice (refrigerant packs). A copy of the shipping manifest is included with each shipment that contains a list of the items contained in the shipment and certain demographic information. Exhibit 8-1, the Blood and urine shipping protocol, illustrates the specifications for the shipment of blood and urine specimens to each contract laboratory.

Packages are shipped using FedEx. The medical technologist in workstation 1 is responsible for contacting FedEx at the start of each stand to determine availability. The facility and equipment specialist (FES) contacts the dry ice company at the start of each stand to establish a contact. It is the chief medical technologist's responsibility to confirm the arrangements for shipping and the dry ice delivery with the FES, prior to or at the beginning of each stand. The chief medical technologist and the FES determine the total weekly weight of dry ice required and the exact shipping dates. The FES makes arrangements with the dry ice company regarding the size and amount of dry ice required for the entire stand, the date the dry is required, and the expected time the dry should be delivered for shipping.

The home office study manager of the laboratory component determines the exact days to ship specimens to the contract laboratories. As a rule, most specimens are packed and shipped once a week during the MEC split examination sessions. Hold the containers for vessels 77, 32-37, 29/89, 90, 92/93, 217, 48, 49, 66, 67, 102, 218, 52, and 139. Ship once they are full, or hold and ship at the end of the stand. All specimens should arrive at the destination the day after shipping. The next-day limitation may conflict with off days, holidays, and vacations. If a conflict with the shipping

schedule, working schedule, or the contract laboratory schedule occurs, consult the home office study manager of the laboratory component.

Exhibit 8-1. Blood and urine shipping protocol

Location	Vessels	Conditions	Vessel storage	Shipping frequency
Whole blood				
CDC/NCEH Air Toxicant Branch Lab 122	VOC Blood Vessel 54	Refrigerated	5 x 5 five-inch box with foam insert	Weekly
CASPIR Lab 6	Lead/Cad/HG/Se/Mn Vessel 1	Frozen	9 x 9 two-inch box	Weekly
CASPIR Lab 6	Cr/Co Vessel 216	Frozen	9 x 9 two-inch box	Weekly
CASPIR Lab 6	RBC Folate Vessel 3	Frozen	10 x 10 two-inch box	Weekly
University of Missouri Lab 10	Glycohem Vessel 4	Refrigerated	9 x 9 two-inch box	Weekly
CASPIR Lab 6	Mercury, Ethyl and Methyl Vessel 5	Frozen	9 x 9 two-inch box	Weekly
Plasma				
Georgia Health Systems Lab 120	Fluoride Vessel 155	Frozen	9 x 9 two-inch box	Weekly
University of Missouri Lab 10	Glucose Vessel 9	Frozen	9 x 9 two-inch box	Weekly
University of Missouri Lab 10	OGTT Vessel 98	Frozen	9 x 9 two-inch box	Weekly
EDTA Washed packed cells				
CASPIR Lab 6	Acrylamide Vessel 88	Frozen	9 x 9 two-inch box	Weekly
Serum				
CASPIR Lab 6	Se/Cu/Zn Vessel 136	Frozen	9 x 9 two-inch box	Weekly
CASPIR Lab 6	Folate Vessel 110	Frozen	10 x 10 two-inch box	Weekly
CASPIR Lab 6	Ferritin/TfR Vessel 99	Frozen	9 x 9 two-inch box	Weekly
CASPIR Lab 6	Vitamin D Vessel 70	Frozen	10 x 10 two-inch box	Weekly

Exhibit 8-1. Blood and urine shipping protocol (continued)

Location	Vessels	Conditions	Vessel storage	Shipping frequency
Serum				
CDC/NCID Hepatitis Ref Lab Lab 2	Hep Profile Vessel 122	Frozen	9 x 9 two-inch box	Weekly
CDC NCID Hepatitis Ref Lab Lab 2	Hepatitis ab Vessel 87	Frozen	9 x 9 two-inch box	Weekly
CASPIR Lab 6	Cotinine Vessel 17	Frozen	9 x 9 two-inch box	Weekly
NHANES Diabetes Laboratory Lab 51	Lipids Vessel 21	Frozen	9 x 9 two-inch box	Weekly
CDC /DVRD/Molecular Epidemiology Lab 52	HPV Serum Vessel 77	Frozen	9 x 9 two-inch box	Full or end of stand
Collaborative Laboratory Services Lab 40	Biochem Vessel 18	Refrigerated	9 x 9 two-inch box	Weekly
University of Missouri Lab 10	Insulin Vessel 23	Frozen	9 x 9 two-inch box	Weekly
Collaborative Laboratory Services Lab 40	CRP Vessel 13	Frozen	9 x 9 two-inch box	Weekly
CDC/NCID AIDS Division Lab 3	HIV Vessel 22	Frozen	9 x 9 two-inch box	Weekly
Emory University Lab 9	HSV Vessel 24	Frozen	9 x 9 two-inch box	Weekly
CASPIR Lab 6	Testosterone/Estradiol/SHBG Vessel 137	Frozen	9 x 9 two-inch box	Weekly
CDC NCEH Air Toxicant Lab 4	Aldehyde Vessel 150	Refrigerated	9 x 9 two-inch box	Weekly
CASPIR Lab 6	Xtra Sera Vessels 32-37	Frozen	9 x 9 two-inch box	Full or end of stand
CASPIR Lab 6	Persis Pest1 Persis Pest2 Vessels 29 & 89	Frozen	9 x 9 three-inch box	Full or end of stand
CDC/NCEH Environmental Health Laboratory Lab 24	Perfluor1 Vessel 90	Frozen	9 x 9 three-inch box	Full or end of stand

Exhibit 8-1. Blood and urine shipping protocol (continued)

Location	Vessels	Conditions	Vessel storage	Shipping frequency
CASPIR Lab 6	BFR1 BFR2 Vessels 92 & 93	Frozen	9 x 9 three-inch box	Full or end of stand
Urine				
University of Minnesota Lab 16	Alb/Creat Vessel 45	Frozen	9 x 9 three-inch box	Weekly
CDC/NCID NCHSTD Lab 5	Chlam/Trichomonas Vessel 46	Frozen	5 x 5 three-inch box	Weekly
CDC/NCID NCHSTD Lab 5	Trichomonas Vessel 154	Frozen	5 x 5 three-inch box	Weekly
CASPIR Lab 6	Fluoride Vessel 217	Frozen	9 x 9 three-inch box	Full or end of stand
CASPIR Lab 6	Spc Arsenic Vessel 86	Frozen	9 x 9 three-inch box	Weekly
CASPIR Lab 6	Prior Pest Vessel 48	Frozen	5 x 5 three-inch box	Full or end of stand
CASPIR Lab 6	Organophos Vessel 49	Frozen	5 x 5 three-inch box	Full or end of stand
CASPIR Lab 6	Urn Merc/Iodine Vessel 62	Frozen	5 x 5 three-inch box	Weekly
CASPIR Lab 6	Heavy Metal Vessel 50	Frozen	5 x 5 three-inch box	Weekly
CASPIR Lab 6	PAH Vessel 66	Frozen	9 x 9 three-inch box	Full or end of stand
CDC/NCEH Environmental Health Laboratory Lab 24	Phthalates Vessel 67	Frozen	9 x 9 three-inch box	Full or end of stand
CASPIR Lab 6	Perchlorate/VOC/ Thiocyante Vessel 102	Frozen	9 x 9 three-inch box	Full or end of stand
CASPIR Lab 6	TSNA/NNAL/NAS Vessel 156	Frozen	9 x 9 three-inch box	Weekly
CASPIR Lab 6	Aromatic Amines Vessel 152	Frozen	9 x 9 three-inch box	Weekly
CASPIR Lab 6	Diisocyanate Vessel 218	Frozen	9 x 9 three-inch box	Full or end of stand
CASPIR Lab 6	Xtra Urine1 Vessel 52	Frozen	9 x 9 three-inch box	Full or end of stand
CASPIR Lab 6	Xtra Urine2 Vessel 139	Frozen	9 x 9 three-inch box	Full or end of stand

8.2 Equipment and Supplies

Exhibit 8-2 contains a list of label/shipping supplies.

Exhibit 8-2. Supplies for labels/shipping

Small styrofoam shipper (14 x 14 x 12)	Medium styrofoam shipper (16 x16 x 15.5)
5-ml cryovial sterile	2-ml cryovial sterile
14-ml snap cap test tube	2-ml cryovial nonsterile
5.25 x 5.25 x 3.0 inch cardboard box with 9 x 9 cardboard grid	Caps for 2-ml cryovial
5.25 x 5.25 x 2.0 inch cardboard box with 9 x 9 cardboard grid	5.25 x 5.25 x 3.0 inch box with 7 x 7 grid
5.25 x 5.25 x 3.0 inch cardboard box with 5x5 grid	10 x 10 three-inch box
10 x 10 two-inch box	
STP-710 Packaging System	U-tek Reusable Refrigerant Packs Large
STP-730 Packaging System	Rubber bands
Plastic bag 9 x 12	Newsprint paper
Absorbent sheets (2 x 2)	Full face shield
Large padded envelope	Lab jackets (Medium, Lg., X-Lg, 2xl.)
Cryo gloves	
Hammer	Dry ice scoop
Tape gun	Packaging tape 2"
Overpack label	Address labels for FedEx class 9 sticker
UN 3373 label	Refrigerate Do Not Freeze label
Keep Frozen label	Avery 5160 labels
Label Zebra (1.125")	Printer ribbon, Zebra (thermal transfer)
Sheet-fed laser labels	Wipes, Terri 13" x 18"
FedEx large boxes	FedEx Class 9 label
Clear FedEx label pouches	Dymo Labels
Toner cartridge (HP Laser Jet 4000)	FedEx preprinted return airbill – stand

8.3 Print Vessel Labels and Label Blood Processing Racks

Before each session, the technologist assigned to workstation 1 prints all labels for all SPs assigned to a session. The correct bar-coded labels automatically print for each SP based on the SP's age, sex, appointment type, and selection into one or more subsamples. Print urine processing, blood processing, packed cells processing, GTT processing labels, and HPV oral rinse for all SPs scheduled into a MEC session. The phlebotomist and the technologist assigned to shipping are responsible for labeling vessels and assembling the blood processing racks. The MEC physician prints the HPV swab labels.

Distribute Labels

- Place urine processing and HPV oral rinse labels at workstation 3 in the laboratory.
- If the SP does not show up for the appointment, it is possible he or she will reschedule. Place the racks on the upper shelf for future use.
- Store the SP's vessels in a zip-closable bag. Place racks in clear plastic bins or in cupboard above workstation 3.
- If the SP has not shown up by the end of the stand, dispose of vessels.

Assemble Blood-Processing Racks

The phlebotomist and the medical technologist assigned to workstation 1 are responsible for labeling vessels and assembling the blood processing racks. Use extreme care in setting up the blood vessel racks and in labeling the vessels with the appropriate bar-code label.

Label each vessel with the appropriate vessel label, according to the protocol. Place the label on the vessel, wrapping it around the vessel horizontally and making sure the label wraps onto itself. Place the label so the first digit of the vessel number is at the top of the vessel. Set the vessels in the cube racks in priority order, using the rack template as an age-specific guide.

Use the following materials to set up and label blood racks:

- Plastic rack
- Template for processing
- Vessels of the following sizes:
 - 2.0-ml sterile vessel
 - 2.0-ml non-sterile vessel
 - 5.0-ml sterile vessel
- Bar-coded SP ID labels each containing the unique 6-digit SP ID number concatenated with the vessel ID

Prepare one blood processing rack for each SP. The set-up of the rack depends on the subject's age, sex, appointment type, and inclusion in selected subsamples. When possible, prepare the racks at least 1 day before the SP arrives for the MEC examination.

- Label all GTT tubes (vessel 98) and place in one rack.
- Label all Acrylamide tubes (vessel 88) and place in the same rack as the GTT tubes, in a different row.
- Place a colored post-it indicating the date and session time on the end of this rack.

Place the pre-labeled blood processing racks and the GTT/acrylamide rack on the counter to the right of the centrifuges at the start of each session.

8.3.1 Print Vessel Labels Using the Label Print Application

Open the Laboratory application. Log onto the computer terminal and select the Label Print Application. This application is found on the desktop of all laboratory computers and has an icon that looks like a barcode label.



8.3.2 Main Printing Screen

From the main printing screen, the current day and next 2 days the MEC is in session will be displayed in a tree view on the left side of the screen. The sessions will be color coded to match the legend at the bottom left-hand side of the screen. Sessions in green indicate that a particular session or SPs within that session need to be printed. Sessions in black have already been printed and there are no SP profile changes. Sessions in blue indicate that an SP was added to that session or that a SP or SPs had a profile change and need to be reprinted. If an SP is removed from a session, that session will be displayed in red, which indicates label action is needed. Sessions with orange indicate labels have already been printed and the rack has been placed on the upper shelf.

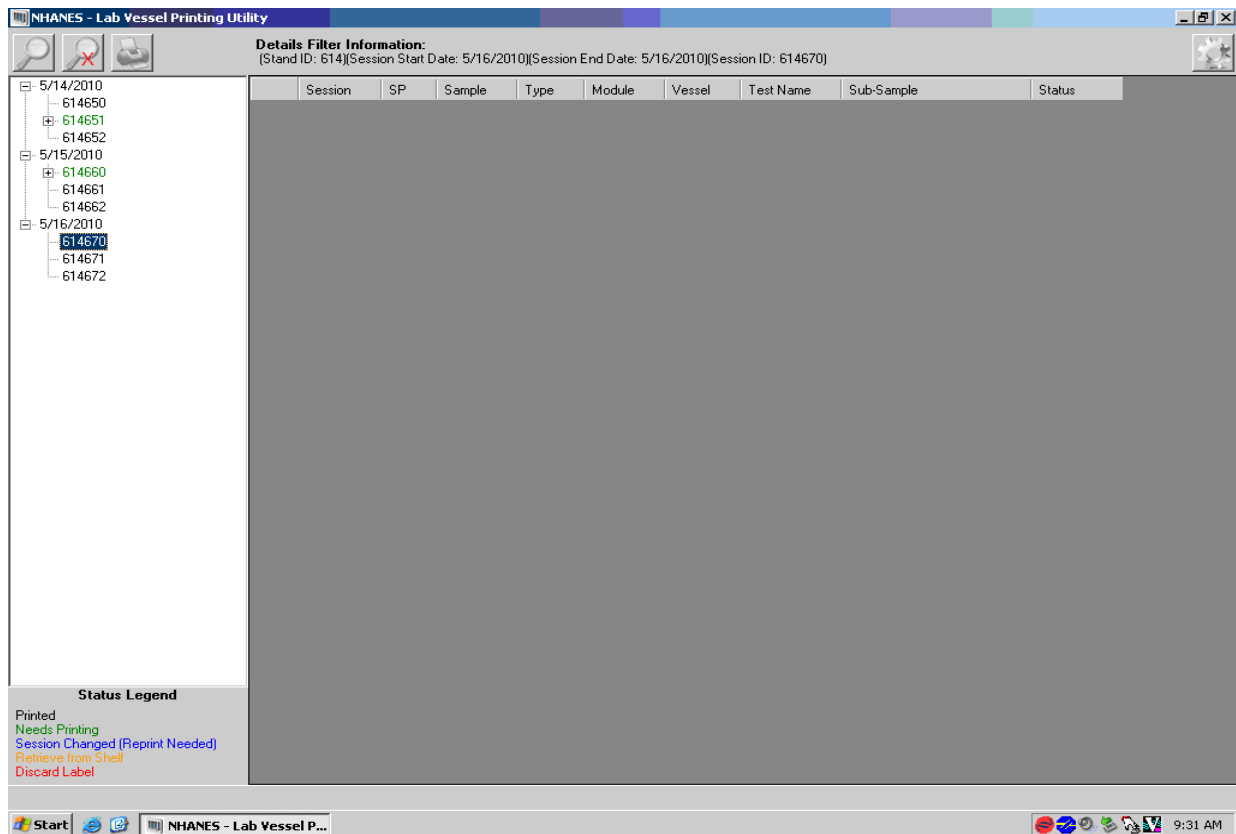

8.3.3 Filter Options

The looking-glass icon is used for the filtering options, where you can filter labels by stand start and end date, session ID, SP ID, or Sample ID. After picking the criteria you would like to filter with, press the filter button. Clearing the filter takes you back to the current date, plus 2 days, and the “Cancel” button takes you back to the main printing screen.

Details Filter Information:
 [Stand ID: 614][Session Start Date: 5/14/2010][Session End Date: 5/16/2010]

Session	SP	Sample	Type	Module	Vessel	Test Name	Sub-Sample	Status
614651	530558	530558	W	BP	1	Lead/Cad/HG		Needs Printing
614651	554728	554728	W	BP	1	Lead/Cad/HG		Needs Printing
614651	731944	731944	W	BP	1	Lead/Cad/HG		Needs Printing
614651	753743	753743	W	BP	1	Lead/Cad/HG		Needs Printing
614651	847833	847833	W	BP	1	Lead/Cad/HG		Needs Printing
614651	889468	889468	W	BP	1	Lead/Cad/HG		Needs Printing
614651	890547	890547	W	BP	1	Lead/Cad/HG		Needs Printing
614651	904789	904789	W	BP	1	Lead/Cad/HG		Needs Printing
614660	211074					/HG		Needs Printing
614660	389587					/HG		Needs Printing
614660	540529					/HG		Needs Printing
614660	565809					/HG		Needs Printing
614660	580885					/HG		Needs Printing
614651	530558					e		Needs Printing
614651	554728					e		Needs Printing
614651	731944					e		Needs Printing
614651	753743					e		Needs Printing
614651	847833					e		Needs Printing
614651	889468	889468	W	BP	3	RBC Folate		Needs Printing
614651	890547	890547	W	BP	3	RBC Folate		Needs Printing
614651	904789	904789	W	BP	3	RBC Folate		Needs Printing
614660	211074					RBC Folate		Needs Printing
614660	389587	389587	W	BP	3	RBC Folate		Needs Printing
614660	540529	540529	W	BP	3	RBC Folate		Needs Printing
614660	565809	565809	W	BP	3	RBC Folate		Needs Printing
614660	580885	580885	W	BP	3	RBC Folate		Needs Printing
614651	554728	554728	W	BP	4	Glycohem		Needs Printing
614651	731944	731944	W	BP	4	Glycohem		Needs Printing
614651	753743	753743	W	BP	4	Glycohem		Needs Printing

Status Legend
 Printed
 Needs Printing
 Session Changed (Reprint Needed)
 Retrieve from Shelf
 Discard Label

8.3.7 Print Options: Module Filter

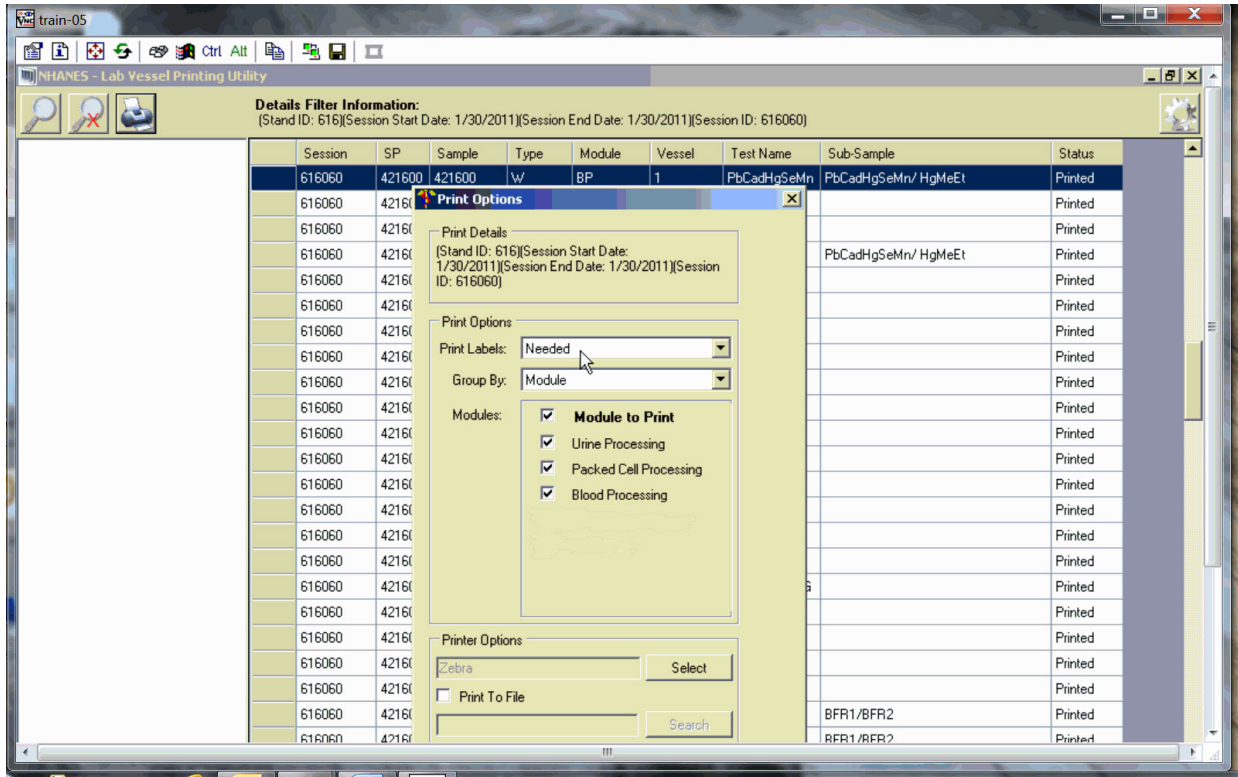

Option to select all modules, a single module, or a combination of modules using the checkbox in front of the desired module.

8.3.8 Print Order

The print order matches the order the vessels are displayed on the print screen for the entire session. All urine vessels are printed first, which are grouped by SP ID. Do not label urine vessels; save urine labels together, which will be distributed to workstation 3 the day of the session being labeled.

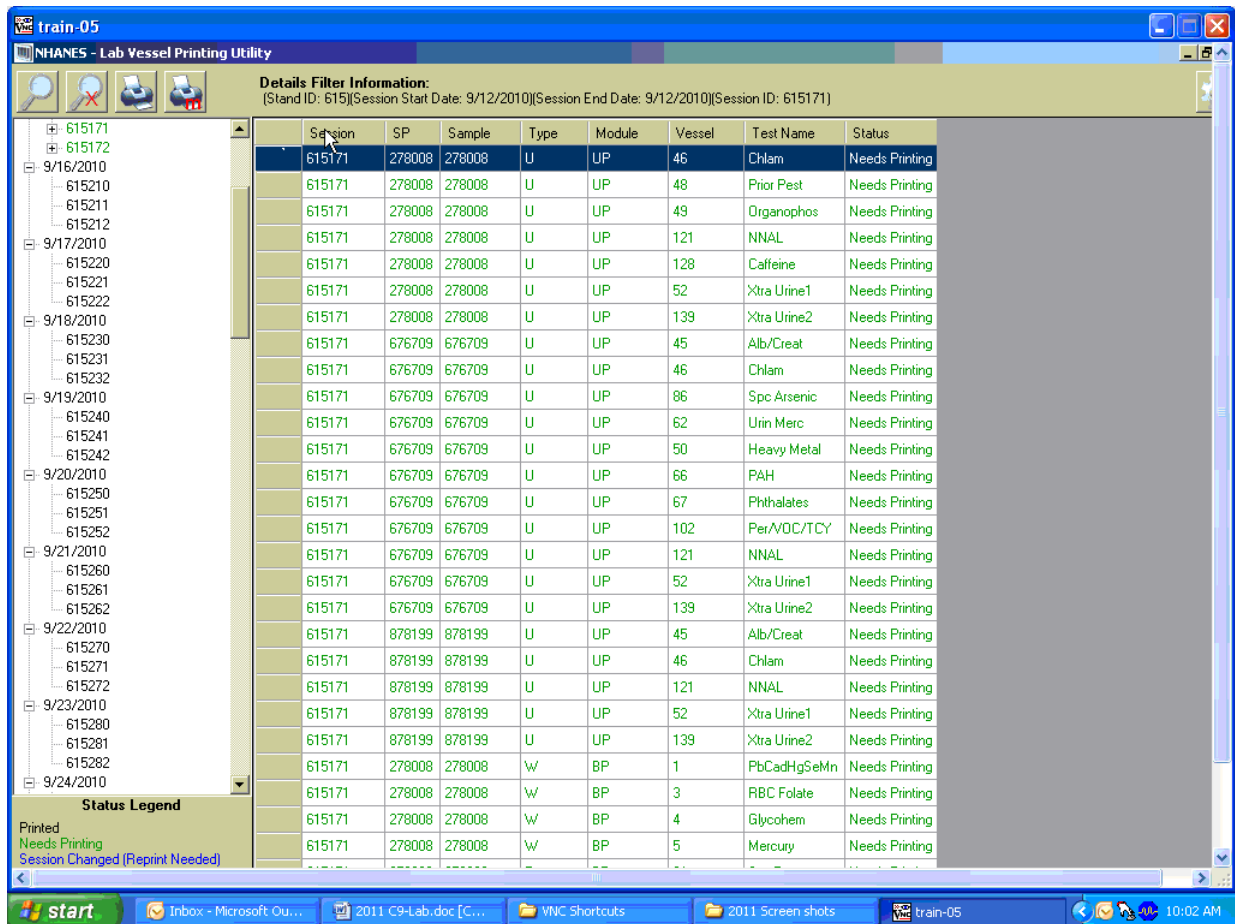

If printing a morning session, the OGTT labels are printed after the blood processing labels. Label the OGTT tubes and put these SPs into a separate rack. The last module to be printed is the HPV oral rinse labels; do not label these tubes. They should be kept with the urine labels and distributed to workstation 3 the day of the session you are labeling. Packed cell labels print before blood processing labels. Label the Packed Cell tubes and place in a separate row in the same rack as the OGTT tubes (if it is a morning session).

8.3.9 Print Display Options

To change the display on the screen to display in numerical order for all SPs, click on the “Vessel” tab and the display will change to numerical order for the entire session.

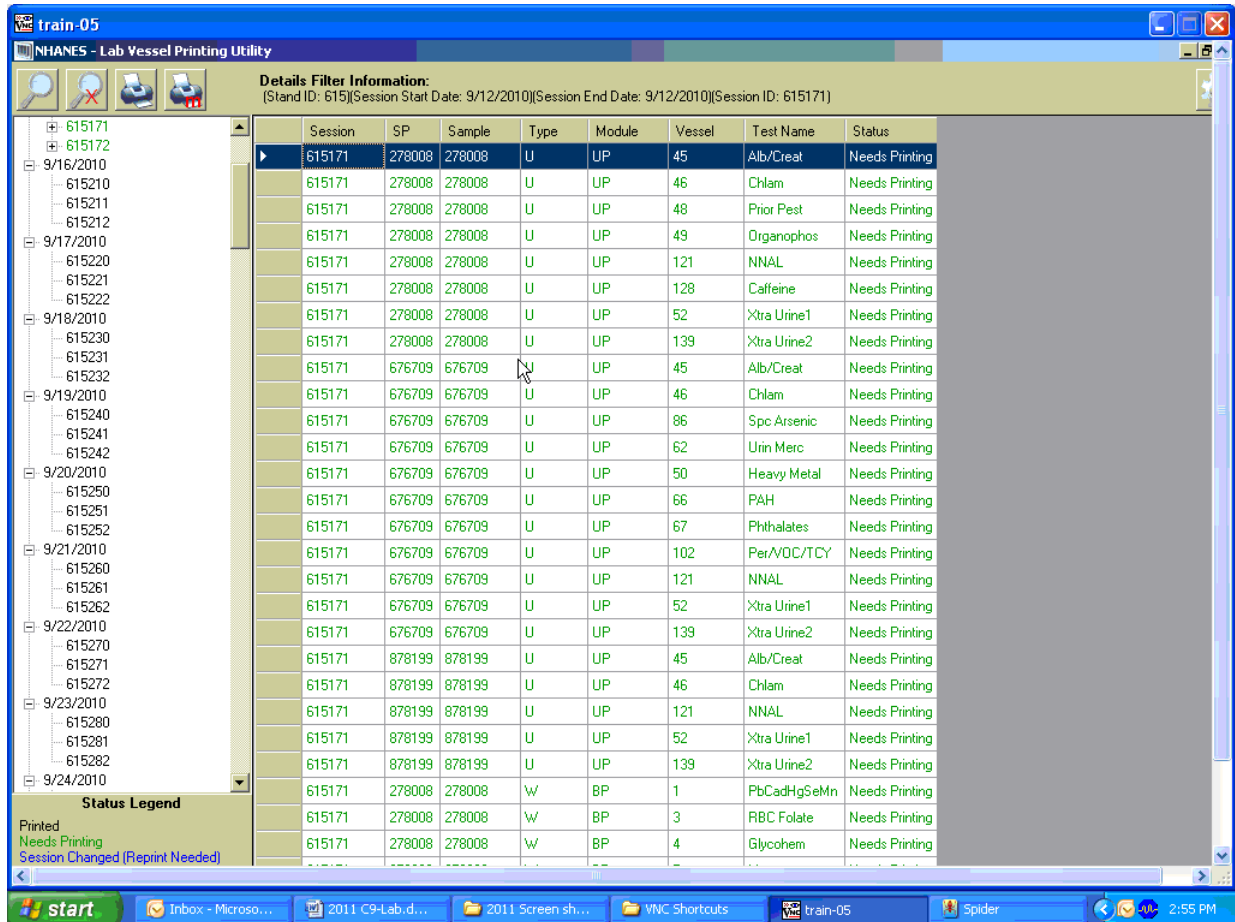

8.3.10 Printing One SP's Labels

Using the tree on the left-hand side of the screen, expand the session by clicking on the + sign to the left of the session number. This will display all the SPs scheduled for that session. Click on the SP you want displayed. Use the printer icon to print using the print options described in Sections 8.3.5 to 8.3.7.

Details Filter Information:
 (Stand ID: 6151) | (Session Start Date: 9/12/2010) | (Session End Date: 9/12/2010) | (Session ID: 615171) | (SP ID: 278008)

Session	SP	Sample	Type	Module	Vessel	Test Name	Status
615171	278008	278008	U	UP	46	Chlam	Needs Printing
615171	278008	278008	U	UP	48	Prior Pest	Needs Printing
615171	278008	278008	U	UP	49	Organophos	Needs Printing
615171	278008	278008	U	UP	121	NNAL	Needs Printing
615171	278008	278008	U	UP	128	Caffeine	Needs Printing
615171	278008	278008	U	UP	52	Xtra Urine1	Needs Printing
615171	278008	278008	U	UP	139	Xtra Urine2	Needs Printing
615171	278008	278008	W	BP	1	PbCadHgSeMn	Needs Printing
615171	278008	278008	W	BP	3	RBC Folate	Needs Printing
615171	278008	278008	W	BP	4	Glycohem	Needs Printing
615171	278008	278008	W	BP	5	Mercury	Needs Printing
615171	278008	278008	P	BP	91	Sm Pest	Needs Printing
615171	278008	278008	S	BP	70	Vit D/FA	Needs Printing
615171	278008	278008	S	BP	122	HAV	Needs Printing
615171	278008	278008	S	BP	17	Cotinine	Needs Printing
615171	278008	278008	S	BP	21	Lipids	Needs Printing
615171	278008	278008	S	BP	77	HPV Serum	Needs Printing
615171	278008	278008	S	BP	18	Biochem	Needs Printing
615171	278008	278008	S	BP	12	Vit B12/MMA	Needs Printing
615171	278008	278008	S	BP	22	HIV	Needs Printing
615171	278008	278008	S	BP	24	HSV	Needs Printing
615171	278008	278008	S	BP	127	IgA-TTG/EMA	Needs Printing
615171	278008	278008	S	BP	137	TST	Needs Printing
615171	278008	278008	S	BP	34	Xtra Sera3	Needs Printing
615171	278008	278008	S	BP	35	Xtra Sera4	Needs Printing
615171	278008	278008	S	BP	36	Xtra Sera5	Needs Printing
615171	278008	278008	S	BP	37	Xtra Sera6	Needs Printing

Status Legend
 Printed
 Needs Printing
 Session Changed (Reprint Needed)

8.3.11 Printing Individual Labels

To print a single or individual label, highlight the line you wish to be printed. Use the printer icon to print using the print options described in Sections 8.3.5 to 8.3.7.

Details Filter Information:
 (Stand ID: 615)|Session Start Date: 9/12/2010|Session End Date: 9/12/2010|Session ID: 615171|SP ID: 278008

Session	SP	Sample	Type	Module	Vessel	Test Name	Status
615171	278008	278008	U	UP	46	Chlam	Needs Printing
615171	278008	278008	U	UP	48	Prior Pest	Needs Printing
615171	278008	278008	U	UP	49	Organophos	Needs Printing
615171	278008	278008	U	UP	121	NNAL	Needs Printing
615171	278008	278008	U	UP	128	Caffeine	Needs Printing
615171	278008	278008	U	UP	52	Xtra Urine1	Needs Printing
615171	278008	278008	U	UP	139	Xtra Urine2	Needs Printing
615171	278008	278008	W	BP	1	PbCadHgSeMn	Needs Printing
615171	278008	278008	W	BP	3	RBC Folate	Needs Printing
615171	278008	278008	W	BP	4	Glycohem	Needs Printing
615171	278008	278008	W	BP	5	Mercury	Needs Printing
615171	278008	278008	P	BP	91	Sm Pest	Needs Printing
615171	278008	278008	S	BP	70	Vit D/FA	Needs Printing
615171	278008	278008	S	BP	122	HAV	Needs Printing
615171	278008	278008	S	BP	17	Cotinine	Needs Printing
615171	278008	278008	S	BP	21	Lipids	Needs Printing
615171	278008	278008	S	BP	77	HPV Serum	Needs Printing
615171	278008	278008	S	BP	18	Biochem	Needs Printing
615171	278008	278008	S	BP	12	Vit B12/MMA	Needs Printing
615171	278008	278008	S	BP	22	HIV	Needs Printing
615171	278008	278008	S	BP	24	HSV	Needs Printing
615171	278008	278008	S	BP	127	IgA-TTG/EMA	Needs Printing
615171	278008	278008	S	BP	137	TST	Needs Printing
615171	278008	278008	S	BP	34	Xtra Sera3	Needs Printing
615171	278008	278008	S	BP	35	Xtra Sera4	Needs Printing
615171	278008	278008	S	BP	36	Xtra Sera5	Needs Printing
615171	278008	278008	S	BP	37	Xtra Sera6	Needs Printing

Status Legend
 Printed
 Needs Printing
 Session Changed (Reprint Needed)

8.3.12 Label Action

If an SP’s profile has changed and the labels have already been printed, the SP line will turn red on the heads-up display and show “Label Action Required.” Blood processing won’t be enabled until the label action is performed.

SP ID	Sample ID	Status	Type	Gender	Age	Name	Process Status						HPV			
							UC	U	P	CB	B	PC	F	M		
329869	329869	SC	P	F	12	HOWARD, CHARLES S	<input type="radio"/>	<input type="radio"/>	<input type="radio"/>	<input type="radio"/>	<input type="radio"/>	<input type="radio"/>	<input type="radio"/>	<input type="radio"/>	<input type="radio"/>	<input type="radio"/>
386827	386827	SC	P	F	26	DEEGAN, DOUG O	<input type="radio"/>	<input type="radio"/>	<input type="radio"/>	<input type="radio"/>	<input type="radio"/>	<input type="radio"/>	<input type="radio"/>	<input type="radio"/>	<input type="radio"/>	<input type="radio"/>
416714	416714	SC	P	F	16	BAILEY, ANTHONY J	<input type="radio"/>	<input type="radio"/>	<input type="radio"/>	<input type="radio"/>	<input type="radio"/>	<input type="radio"/>	<input type="radio"/>	<input type="radio"/>	<input type="radio"/>	<input type="radio"/>
499508	499508	SC	P	F	5	DEEGAN, MARK	<input type="radio"/>	<input type="radio"/>	<input type="radio"/>	<input type="radio"/>	<input type="radio"/>	<input type="radio"/>	<input type="radio"/>	<input type="radio"/>	<input type="radio"/>	<input type="radio"/>
525757	525757	SC	P	M	3	LAST NAME, PAT M	<input type="radio"/>	<input type="radio"/>	<input type="radio"/>	<input type="radio"/>	<input type="radio"/>	<input type="radio"/>	<input type="radio"/>	<input type="radio"/>	<input type="radio"/>	<input type="radio"/>
745052	745052	SC	P	F	12	TIM, SP FIRST NAME M	<input type="radio"/>	<input type="radio"/>	<input type="radio"/>	<input type="radio"/>	<input type="radio"/>	<input type="radio"/>	<input type="radio"/>	<input type="radio"/>	<input type="radio"/>	<input type="radio"/>
767995	767995	SC	P	F	39	NAME, LAST M	<input type="radio"/>	<input type="radio"/>	<input type="radio"/>	<input type="radio"/>	<input type="radio"/>	<input type="radio"/>	<input type="radio"/>	<input type="radio"/>	<input type="radio"/>	<input type="radio"/>
836040	836040	SC	P	M	54	TORRES, LUCAS T	<input type="radio"/>	<input type="radio"/>	<input type="radio"/>	<input type="radio"/>	<input type="radio"/>	<input type="radio"/>	<input type="radio"/>	<input type="radio"/>	<input type="radio"/>	<input type="radio"/>
849425	849425	SC	P	F	16	CAMPBELL, VINNIE N	<input type="radio"/>	<input type="radio"/>	<input type="radio"/>	<input type="radio"/>	<input type="radio"/>	<input type="radio"/>	<input type="radio"/>	<input type="radio"/>	<input type="radio"/>	<input type="radio"/>
919919	919919	SC	P	M	57	PAYNE, IMA L	<input type="radio"/>	<input type="radio"/>	<input type="radio"/>	<input type="radio"/>	<input type="radio"/>	<input type="radio"/>	<input type="radio"/>	<input type="radio"/>	<input type="radio"/>	<input type="radio"/>

Open up the Lab printing application.

The session will be displayed in the tree in green, which indicates something needs to be printed. Click on the SP ID in the tree; the SP will also be displayed in green because labels will need to be printed and some will need to be discarded. Labels that need to be discarded are displayed in red.

NHANES - Lab Vessel Printing Utility

Details Filter Information:
 (Stand ID: 615)(Session Start Date: 10/9/2010)(Session End Date: 10/9/2010)(Session ID: 615440)(SP ID: 197633)

Session	SP	Sample	Type	Module	Vessel	Test Name	Status
615440	197633	197633	W	BP	3	RBC Folate	Printed
615440	197633	197633	W	BP	4	Glycohem	Discard Label
615440	197633	197633	W	BP	5	Mercury	Printed
615440	197633	197633	P	BP	9	Glucose	Discard Label
615440	197633	197633	S	BP	136	Se/Cu/Zn	Printed
615440	197633	197633	S	BP	70	Vit D/FA	Printed
615440	197633	197633	S	BP	122	HAV	Printed
615440	197633	197633	S	BP	17	Cotinine	Printed
615440	197633	197633	S	BP	21	Lipids	Printed
615440	197633	197633	S	BP	18	Biochem	Discard Label
615440	197633	197633	S	BP	23	Insulin	Discard Label
615440	197633	197633	S	BP	12	Vit B12/MMA	Discard Label
615440	197633	197633	S	BP	118	Thyroid	Discard Label
615440	197633	197633	S	BP	127	IgA-TTG/EMA	Printed
615440	197633	197633	S	BP	137	TST	Printed
615440	197633	197633	S	BP	110	Folate 1	Printed
615440	197633	197633	S	BP	32	Xtra Sera1	Needs Printing
615440	197633	197633	S	BP	33	Xtra Sera2	Needs Printing
615440	197633	197633	S	BP	34	Xtra Sera3	Discard Label
615440	197633	197633	S	BP	35	Xtra Sera4	Discard Label
615440	197633	197633	S	BP	36	Xtra Sera5	Discard Label
615440	197633	197633	S	BP	37	Xtra Sera6	Discard Label
615440	197633	197633	S	BP	29	Pers Pest1	Discard Label
615440	197633	197633	S	BP	89	Pers Pest2	Discard Label
615440	197633	197633	S	BP	90	Perfluor	Discard Label
615440	197633	197633	S	BP	92	BFR1	Discard Label
615440	197633	197633	S	BP	93	BFR2	Discard Label
615440	197633	197633	P	TT	98	OGTT	Discard Label
615440	197633	197633	C	OR	129	HPV Rinse	Discard Label

Status Legend
 Printed
 Needs Printing
 Session Changed (Reprint Needed)
 Retrieve from Shelf
 Discard Label

Lab Vessel Printing Utility (Version: 1.5)

Start | Lab Subsystem | NHANES - Lab Vessel P... | 3:30 PM

Click on the printer icon and print what is needed. Right-click on a line that is displayed in red to mark label as discarded. Two options are available for discarding, either individually or all.

train-05
NHANES - Lab Vessel Printing Utility

Details Filter Information:
(Stand ID: 615)(Session Start Date: 10/9/2010)(Session End Date: 10/9/2010)(Session ID: 615440)(SP ID: 197633)

Session	SP	Sample	Type	Module	Vessel	Test Name	Status
615440	197633	197633	U	UP	45	Alb/Creat	Printed
615440	197633	197633	U	UP	86	Spc Arsenic	Printed
615440	197633	197633	U	UP	62	Urin Merc	Printed
615440	197633	197633	U	UP	50	Heavy Metal	Printed
615440	197633	197633	U	UP	66	PAH	Printed
615440	197633	197633	U	UP	67	Phthalates	Printed
615440	197633	197633	U	UP	102	Per/VOC/TCY	Printed
615440	197633	197633	U	UP	121	NNAL	Printed
615440	197633	197633	U	UP	52	Xtra Urine1	Printed
615440	197633	197633	U	UP	139	Xtra Urine2	Printed
615440	197633	197633	W	BP	1	PbCadHgSeMn	Printed
615440	197633	197633	W	BP	3	RBC Folate	Printed
615440	197633	197633	W	BP	4	Glycohem	Discard Label
615440	197633	197633	W	BP	5	Mercury	Printed
615440	197633	197633	W	BP	6	Glucose	Discard Label
615440	197633	197633	W	BP	7	Se/Cu/Zn	Printed
615440	197633	197633	W	BP	8	Vit D/FA	Printed
615440	197633	197633	W	BP	9	HAV	Printed
615440	197633	197633	S	BP	17	Cotinine	Printed
615440	197633	197633	S	BP	21	Lipids	Printed
615440	197633	197633	S	BP	18	Biochem	Discard Label
615440	197633	197633	S	BP	23	Insulin	Discard Label
615440	197633	197633	S	BP	12	Vit B12/MMA	Discard Label
615440	197633	197633	S	BP	118	Thyroid	Discard Label
615440	197633	197633	S	BP	127	IgA-TTG/EMA	Printed
615440	197633	197633	S	BP	137	TST	Printed
615440	197633	197633	S	BP	110	Folate 1	Printed

Status Legend
Printed
Needs Printing
Session Changed (Reprint Needed)

After completing the Label Action, return to heads-up display and allow the display to update before proceeding. After update, the SP will change from red to black and blood processing can be accessed.

SP ID	Sample ID	Status	Type	Gender	Age	Name	Process Status						HPV	
							UC	U	P	CB	B	PC	F	M
329869	329869	SC	P	F	12	HOWARD, CHARLES S	<input type="radio"/>	<input type="radio"/>	<input type="radio"/>	<input type="radio"/>	<input type="radio"/>	<input type="radio"/>	-	-
386827	386827	SC	P	F	26	DEEGAN, DOUG O	<input type="radio"/>	<input type="radio"/>	<input type="radio"/>	<input type="radio"/>	<input type="radio"/>	-	<input type="radio"/>	-
416714	416714	SC	P	F	16	BAILEY, ANTHONY J	<input type="radio"/>	<input type="radio"/>	<input type="radio"/>	<input type="radio"/>	<input type="radio"/>	<input type="radio"/>	<input type="radio"/>	-
499508	499508	SC	P	F	5	DEEGAN, MARK	<input type="radio"/>	<input type="radio"/>	-	<input type="radio"/>	<input type="radio"/>	-	-	-
525757	525757	SC	P	M	3	LAST NAME, PAT M	<input type="radio"/>	<input type="radio"/>	-	<input type="radio"/>	<input type="radio"/>	-	-	-
745052	745052	SC	P	F	12	TIM, SP FIRST NAME M	<input type="radio"/>	<input type="radio"/>	<input type="radio"/>	<input type="radio"/>	<input type="radio"/>	-	-	-
767995	767995	SC	P	F	39	NAME, LAST M	<input type="radio"/>	<input type="radio"/>	<input type="radio"/>	<input type="radio"/>	<input type="radio"/>	-	<input type="radio"/>	-
836040	836040	SC	P	M	54	TORRES, LUCAS T	<input type="radio"/>	<input type="radio"/>	-	<input type="radio"/>	<input type="radio"/>	-	-	<input type="radio"/>
849425	849425	SC	P	F	16	CAMPBELL, VINNIE N	<input type="radio"/>	<input type="radio"/>	<input type="radio"/>	<input type="radio"/>	<input type="radio"/>	<input type="radio"/>	<input type="radio"/>	-
919919	919919	SC	P	M	57	PAYNE, IMA L	<input type="radio"/>	<input type="radio"/>	-	<input type="radio"/>	<input type="radio"/>	<input type="radio"/>	-	<input type="radio"/>

For SPs that canceled or did not show for their appointment and have rescheduled to a new session, the label print application will trigger the SP to be shelved. These SP will be displayed in orange in the tree in the label print application. Find the corresponding rack from the top shelf in workstation 1 and right click to bring up the action box, click Retrieved All Shelved Labels.

Details Filter Information:
(Stand ID: 615)(Session Start Date: 11/15/2010)(Session End Date: 11/15/2010)(Session ID: 615810)(SP ID: 545182)

Session	SP	Sample	Type	Module	Vessel	Test Name	Sub-Sample	Status
615810	545182	545182	S	BP	23	Insulin		Printed
615810	545182	545182	P	TT	98	OGTT		Printed
615810	545182	545182	P	BP	9	Glucose		Printed
615810	545182	545182	S	BP	137	TST-Ea/SHBG		Shelved
615810	545182	545182	S	BP	13	CRP		Shelved
615810	545182	545182	S	BP	24	Urea		Shelved
615810	545182	545182	S	BP	77			Shelved
615810	545182	545182	S	BP	18			Shelved
615810	545182	545182	S	BP	21			Shelved
615810	545182	545182	S	BP	25			Shelved
615810	545182	545182	S	BP	29		Feet2/Pefflor1	Shelved
615810	545182	545182	C	OR	129	HPV Rinse		Shelved
615810	545182	545182	S	BP	90	Pefflor	Feet1 and Doone/Feet2/Pefflor1	Shelved
615810	545182	545182	S	BP	35	Xtra Sens4		Shelved
615810	545182	545182	S	BP	34	Xtra Sens3		Shelved
615810	545182	545182	S	BP	37	Xtra Sens5		Shelved
615810	545182	545182	S	BP	36	Xtra Sens5		Shelved
615810	545182	545182	S	BP	17	Cobmine		Shelved
615810	545182	545182	U	UP	67	Phthalates	Phthalates	Shelved
615810	545182	545182	U	UP	43	Organophos	Organophosphate Pesticide	Shelved
615810	545182	545182	U	UP	139	Xtra Urine2		Shelved
615810	545182	545182	U	UP	52	Xtra Urine1		Shelved
615810	545182	545182	U	UP	46	Chien/Toch		Shelved
615810	545182	545182	U	UP	45	Abi/Creal		Shelved
615810	545182	545182	U	UP	48	Prior Post	EPA Priority Pesticide	Shelved
615810	545182	545182	U	UP	217	Fluoride		Shelved
615810	545182	545182	S	BP	110	Folate-1		Shelved
615810	545182	545182	P	BP	155	Fluoride		Shelved
615810	545182	545182	S	BP	122	Hep profile		Shelved
615810	545182	545182	S	BP	70	Vitamin D		Shelved
615810	545182	545182	W	BP	3	RBC Folate		Shelved
615810	545182	545182	W	BP	1	Pb/Cd/Hg/Se/Mn	Pb/Cd/Hg/Se/Mn/ Hg/Me/E	Shelved
615810	545182	545182	W	BP	5	Mercury	Pb/Cd/Hg/Se/Mn/ Hg/Me/E	Shelved

Status Legend
 Shaded
 Needs Printing
 Session Changed (Reprint Needed)
 Cancelled
 Discard Label

8.3.13 Label Printing Cheat Sheet

Open Lab Vessel Printing Utility

- Select session number you wish to print.
 - Click on print button at the top.
 - Print screen will default to print all needed.
 - Click on print button at the bottom of print screen.

2. If the session is blue in color:
 - Click on (+) sign before session number; this will open up the session and allow you to see what needs to be done.
3. If there is a gold-colored number you need to find this in the rescheduled area or in a session that is already printed.
 - You will need to reprint urine, HPV oral rinse labels, OGTT, and acrylamide labels. Highlight the SP number, click print button, change needed to all, deselect blood, Click print button.
 - You then need to retrieve all shelved labels. Select any gold test and right-click; a box will appear. Click on the line that says “Retrieve all shelved labels,” and wait.
4. If there is more than one gold number:, you then need to retrieve all shelved labels.
 - Select any gold test and right-click; a box will appear. Click on the line that says “Retrieve all shelved labels,” and wait. This will retrieve all the gold-colored SP labels.
5. Green SP numbers:
 - These need to be printed.
 - Select session number and Click print button.
6. Red SP numbers: This means there is a vial that you need to pull from rack and scan to discard.
7. To get more days to appear:
 - Click the magnifying glass.
 - Select the day that you want to see in both slots.

NOTE: The fewer days you select, the quicker the filter will work.

8.4 Create New Container Labels

Store processed vessels and biological samples in boxes and bags (containers). Print and assign container labels using the Create New Container Labels module. Once a label has been created, the container is designated as “open” in the database; it is available for slot assignments as vessels are marked as filled.

At the beginning of each stand, print and assign one new container ID for each vessel using either the Print module or the Shipping module. Print additional labels as needed. Each stand is allocated a maximum of 999 labels. The actual container label will include the vessel name, vessel ID, the size of the container (9 x 9 x 2-inch box, etc.), and the container number.

Chlam/GC (46)
5x5 3 inch box



Prior Pest (48)
5x5 3 inch box



Use the Shipping module within the laboratory application to print and assign new container ID numbers or labels.

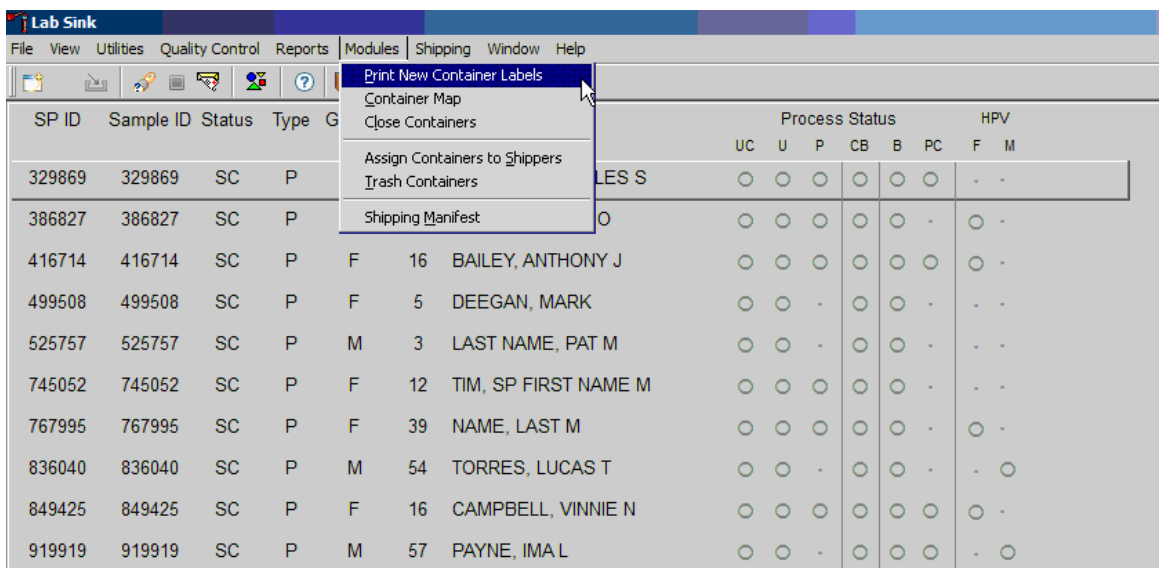

To access the Print New Container Labels module, direct the mouse arrow to Shipping in the menu bar and left-click, drag the mouse arrow to Print New Container Labels, and left-click.

There are three instances when it is appropriate to use this module. At the start of each stand, create one new container label for each vessel ID or “group.” Use the same module to create a new label for a vessel after the last slot in an open container is filled. Use this module to print additional labels at any time.

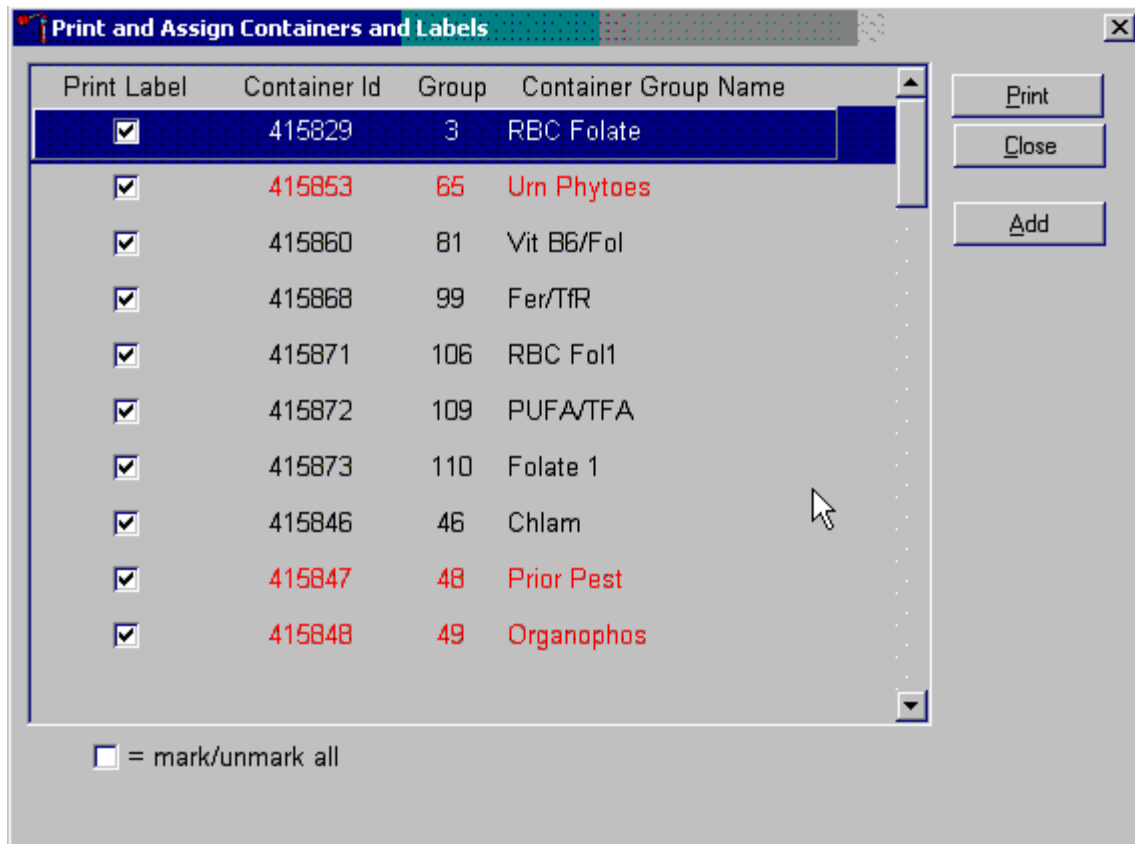

The Print and Assign Containers and Labels window displays once the “Print New Container” module is accessed. The window includes checkboxes to mark or identify specific groups, new Container Ids that are assigned to the Groups, the number of the Group, and the Container Group Name or vessel name. The Group and corresponding Container Group Name listed in this screen represent the Group where the container has been “closed” and a new label has not been created. This screen also includes a “mark/unmark all” checkbox and three buttons: Print, Close, and Add. Use the “Print” button to print the container labels, use the “Close” button to exit the module without printing any labels or assigning Container IDs to the Groups, and use the “Add” button to open another window that allows the user to add additional or multiple labels for any vessel. The information for the containers that do not close weekly is displayed in red.

Individually mark the Print Label checkbox to identify vessels that require labels.

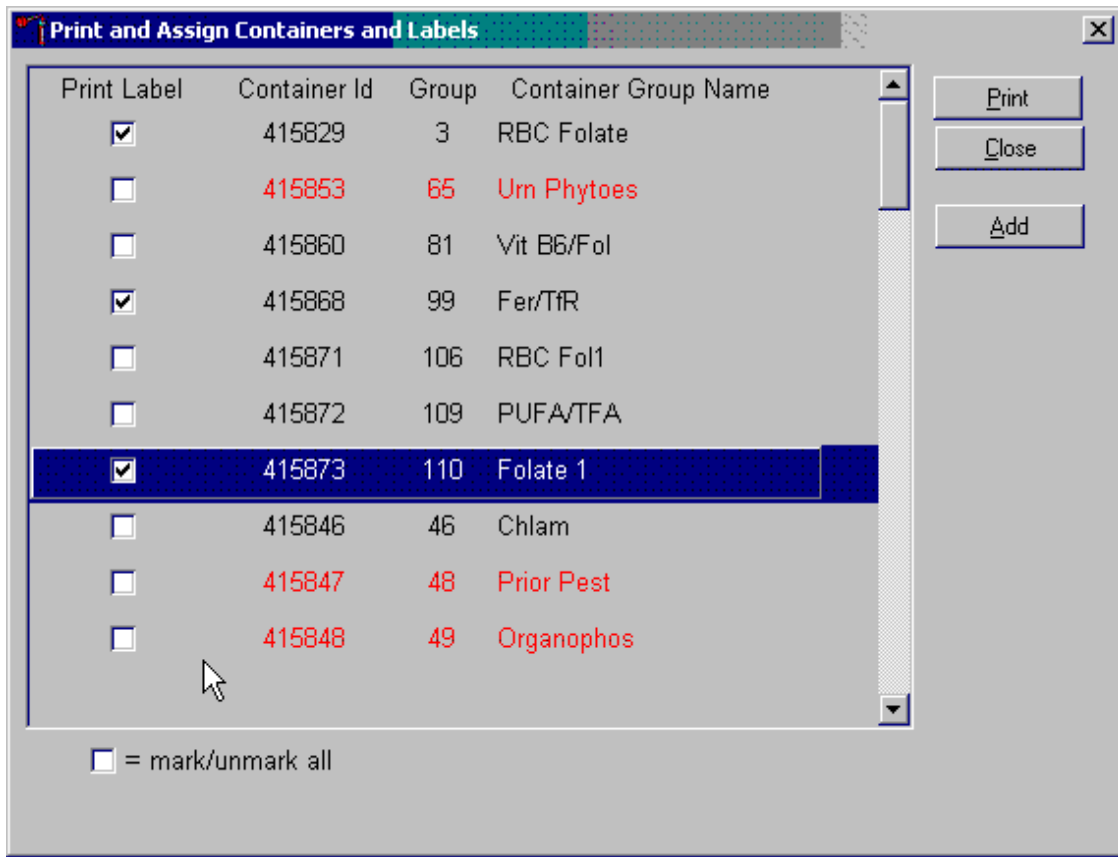

To begin the process of printing and assigning new Container IDs, mark the individual check boxes that correspond to the Group (vessel) of interest. To add a checkmark to the Print Label checkbox, direct the mouse arrow to the Print Label checkbox and left-click.

Collectively mark all the Print Label checkboxes for all the Groups listed in the window.

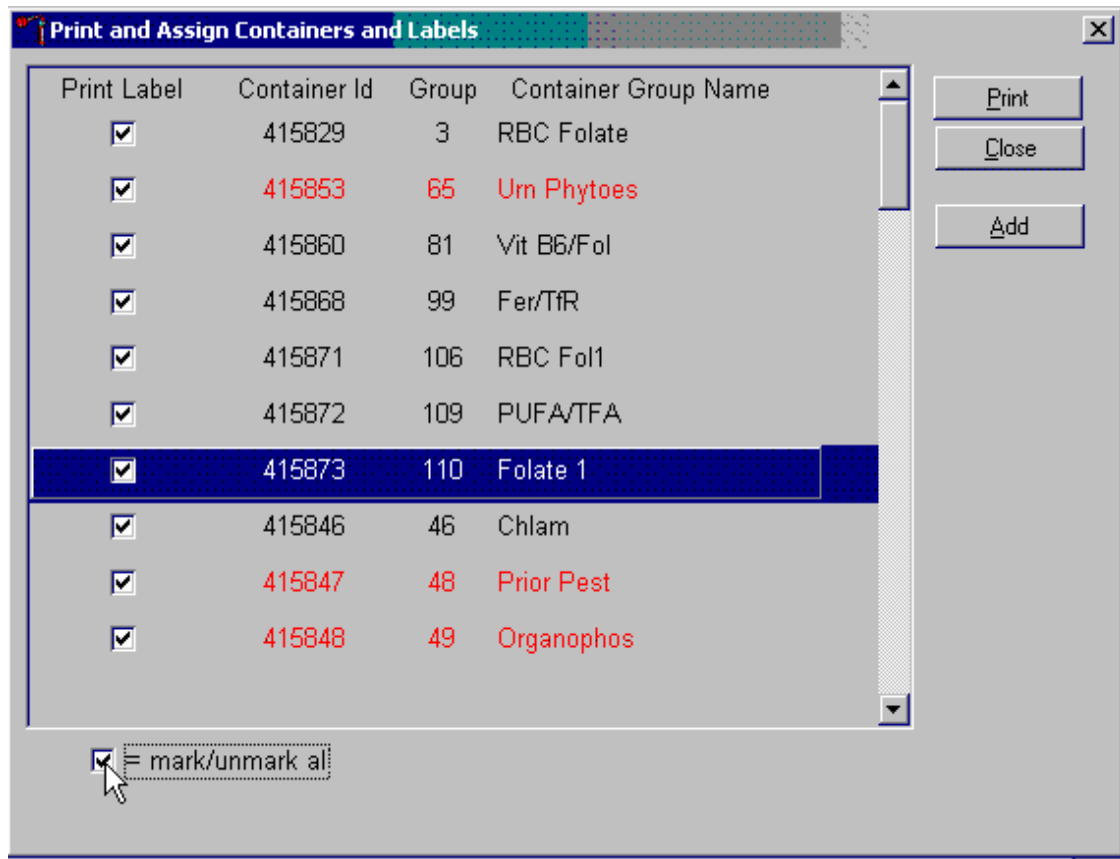

To collectively mark all the checkboxes, direct the mouse arrow to the mark/unmark all checkbox and left-click. To collectively unmark all the checkboxes, direct the mouse arrow to the mark/unmark all checkboxes and left-click.

Access the Generate Additional Containers window to print additional labels for any Group at any time.

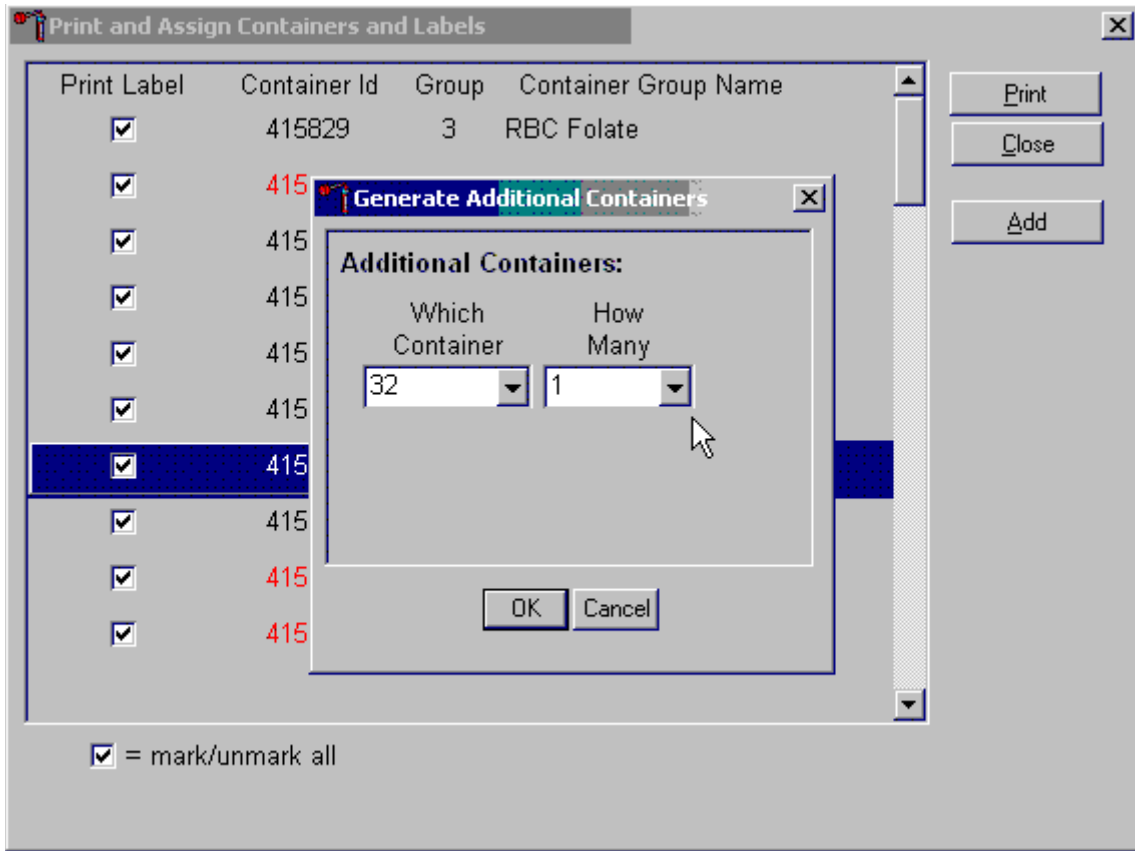

To access the Generate Additional Containers window, direct the mouse arrow to the “Add” button and left-click.

The Generate Additional Containers window displays.

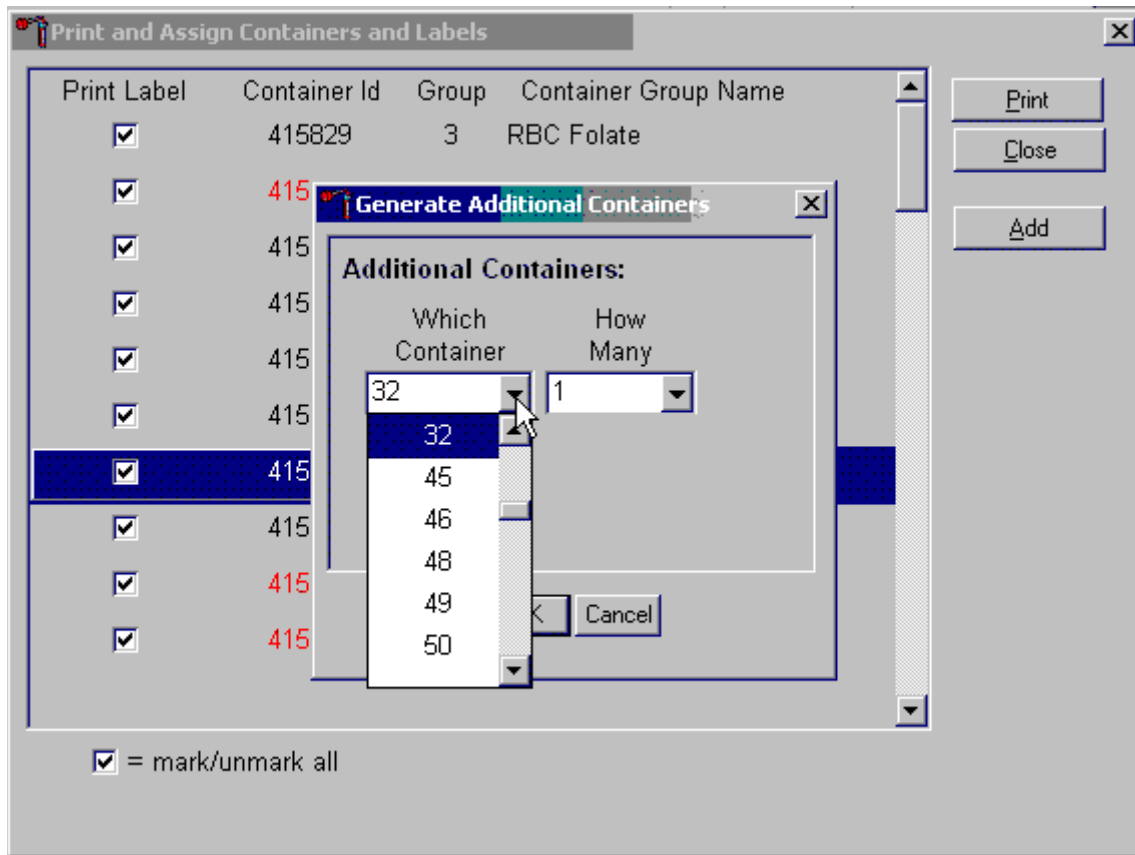

The Generate Additional Containers window includes two text boxes with drop-down lists: Which Container and How Many. The Which Container text box defaults to vessel 32. To select a vessel other than 32, direct the mouse arrow to the drop-down arrow and left-click, drag the arrow to the desired choice and left-click. Use the scroll bar to view all the choices.

Select the number (1-5) of additional container labels.

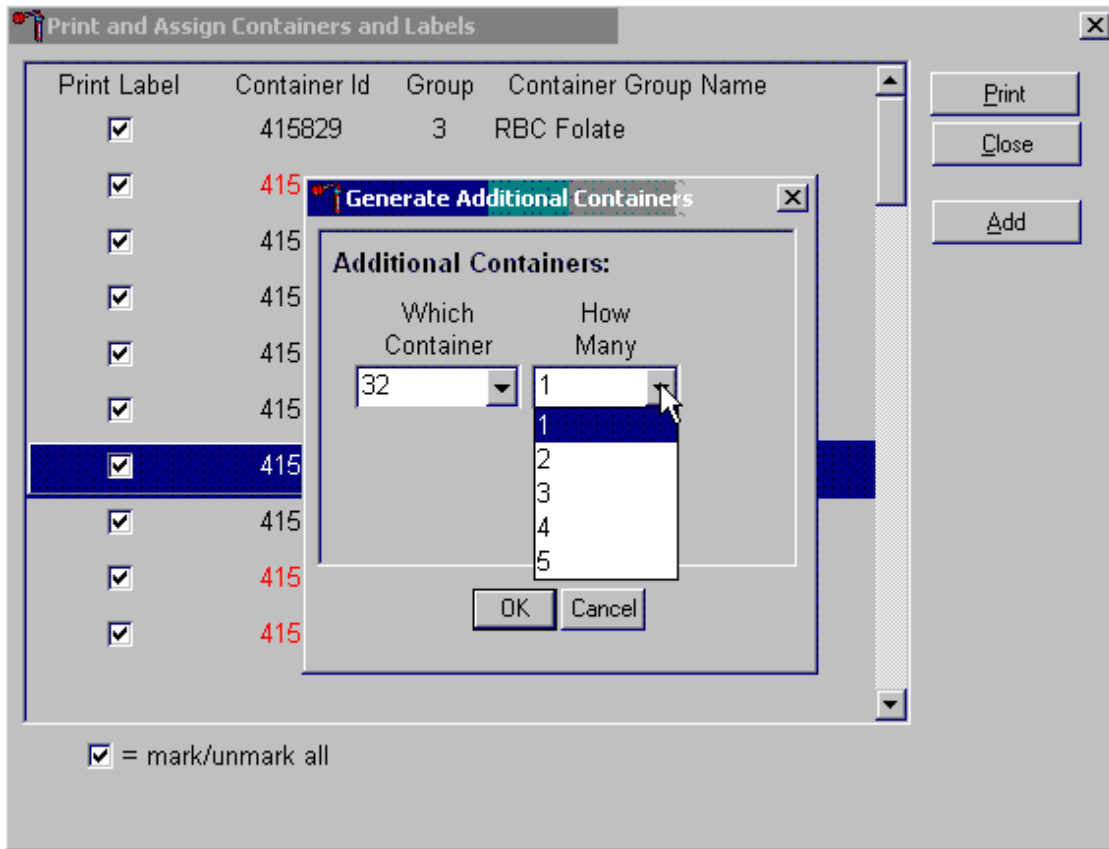

The How Many text box defaults to vessel 1. To select 2, 3, 4, or 5, direct the mouse arrow to the drop-down arrow and left-click, then drag the arrow to the desired choice and left-click. Use the scroll bar to view all the choices.

Add these vessels to the Print and Assign Containers and Labels window or cancel the action.

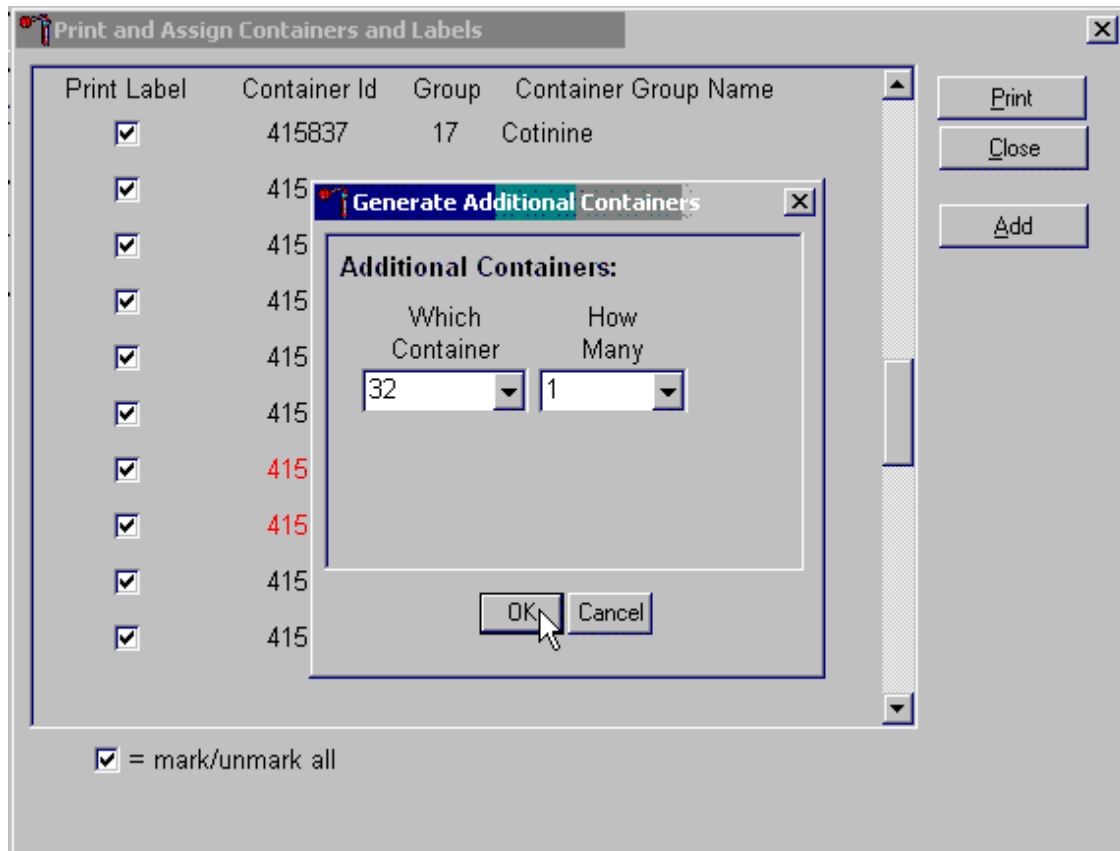

To accept the choices displayed in the Generate Additional Containers window, direct the mouse arrow to the OK button and left-click or type [Enter]. To close the window without creating a new container, direct the mouse arrow to the Cancel button and left-click.

If the OK button is selected, then the containers are added to the Print and Assign Containers and Labels window.

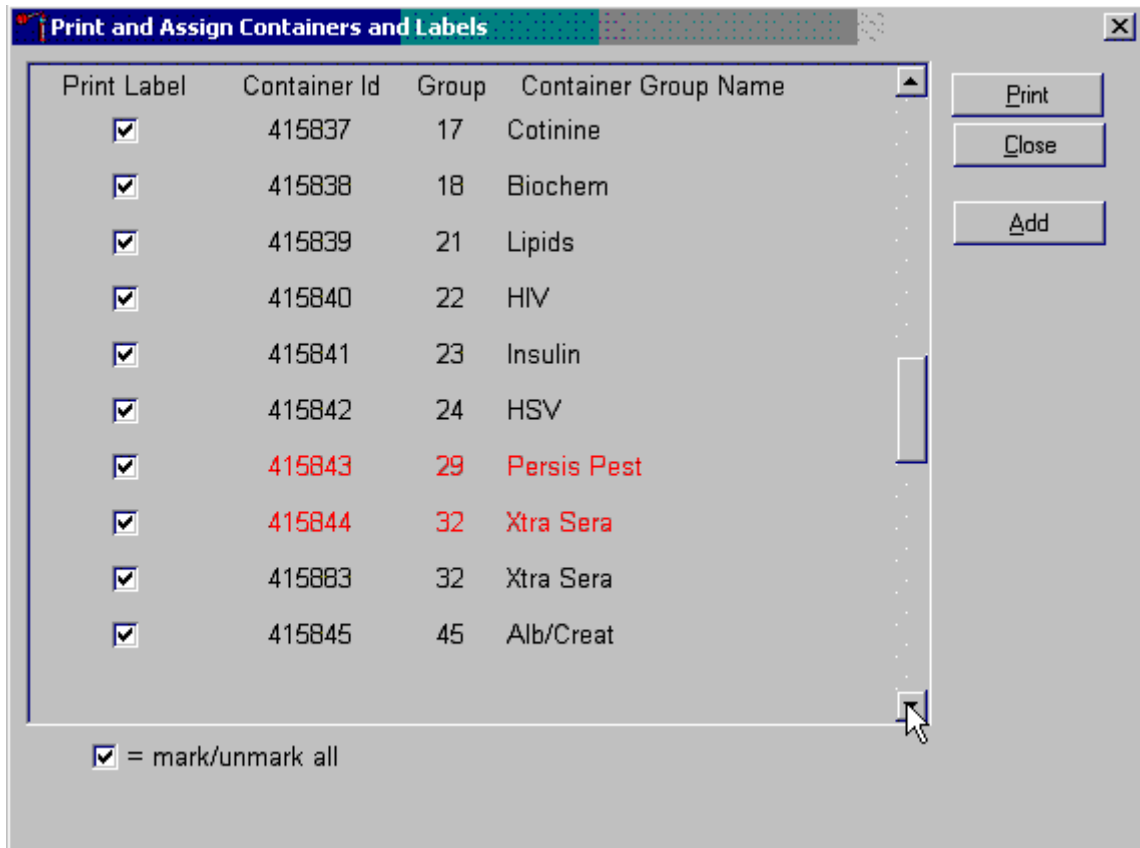

Review the information on the screen.

Complete the assignment process and print the labels.

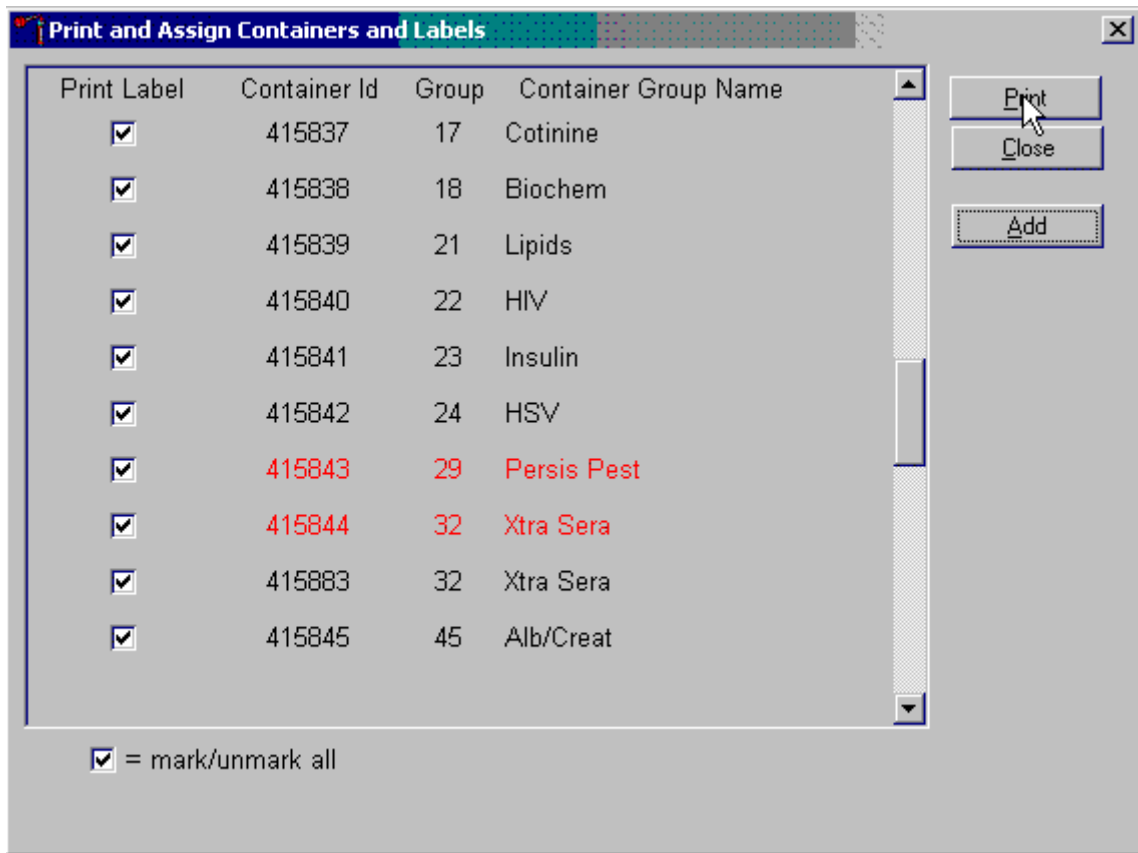

After reviewing the screen, print the labels. To print the labels, direct the mouse arrow to the “Print” button and left-click. To exit the window without printing any labels, direct the mouse arrow to the “Close” button and left-click. Affix the container ID label(s) to the container(s) of the correct type.

If the “Close” button is selected before the labels have been printed, then a Print and Assign Containers and Labels window displays.

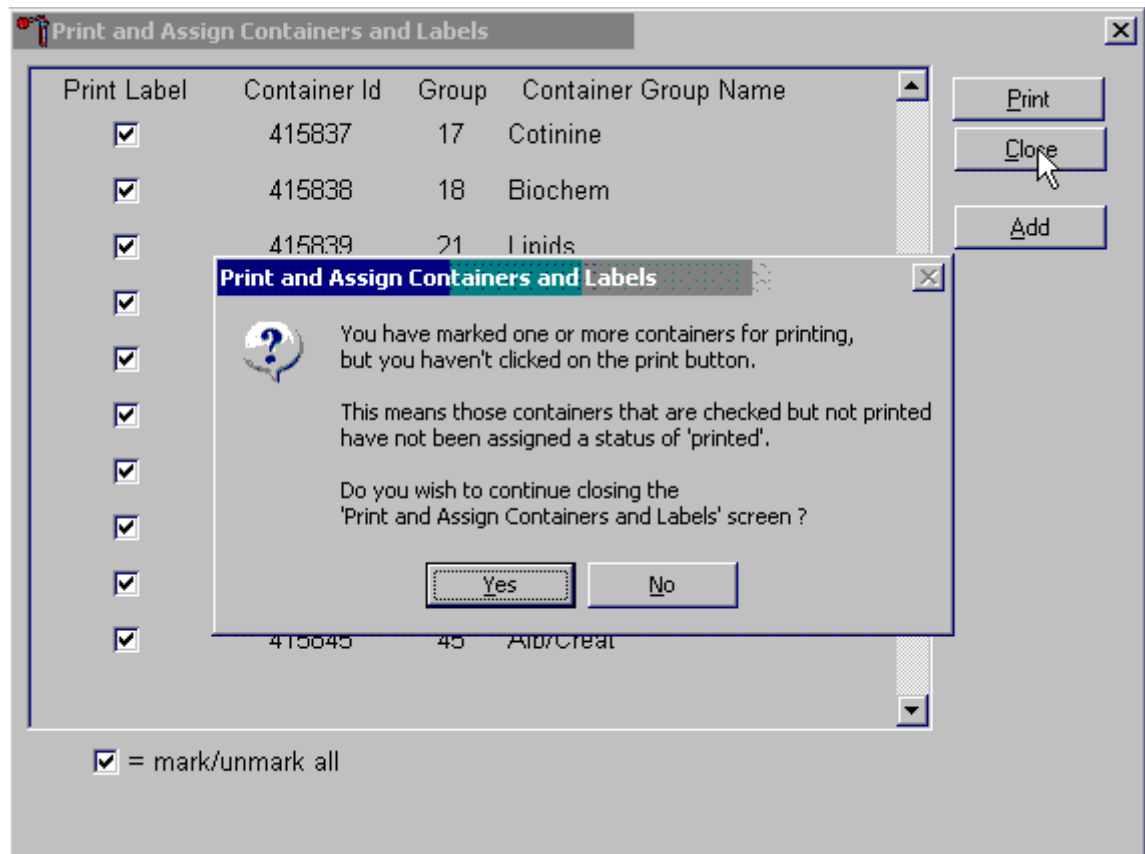

Review the text. To close the Print and Assign Containers and Labels screen, select the “Yes” button. To return to the Print and Assign Containers and Labels screen, select the “No” button.

When a container is full, the container will automatically “close,” and the Print and Assign Containers and Labels window opens with that vessel displayed and the check mark prefilled. Alternatively, open a new container to replace the closed container by using the Print and Assign Containers and Labels window.

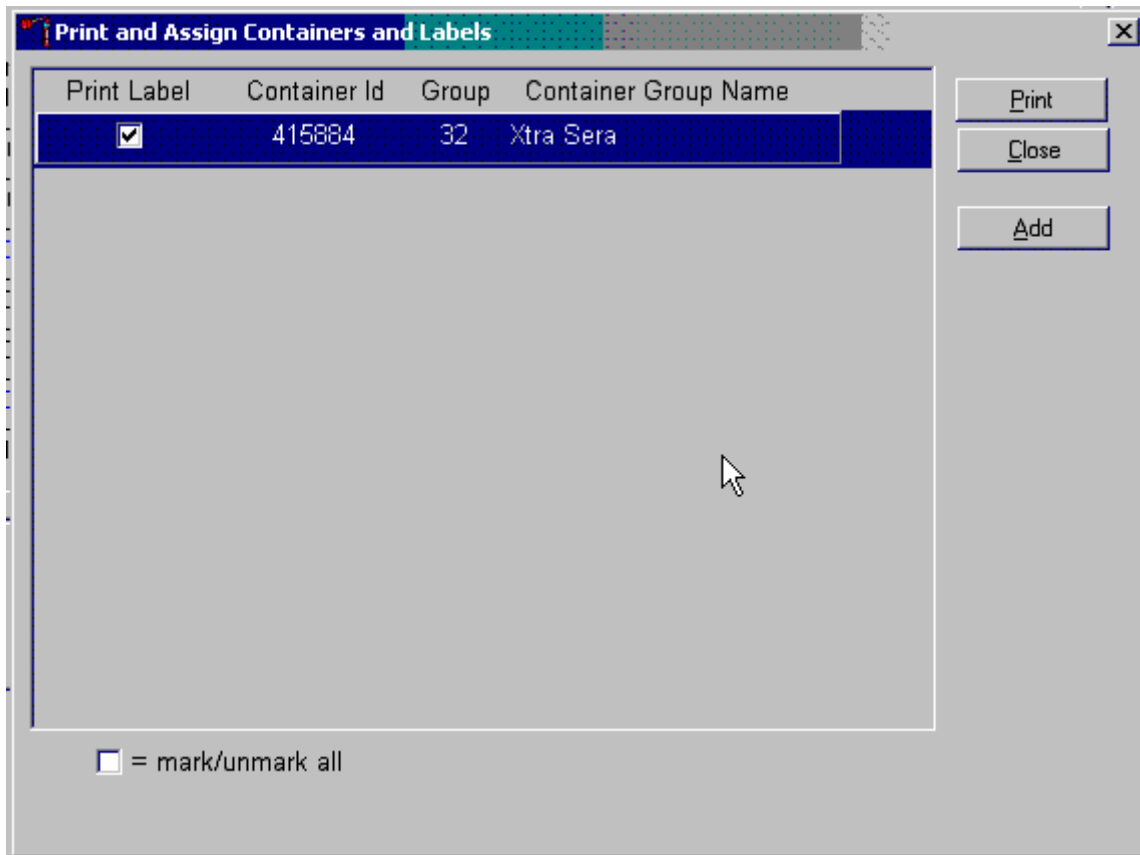

When a container is full, an opportunity to open a new container is automatically displayed on the “Print and Assign Container and Labels” window. Repeat the process of marking the checkbox and selecting the “Print” button.

8.5 Close Containers

Use the shipping module with the laboratory application to close containers.

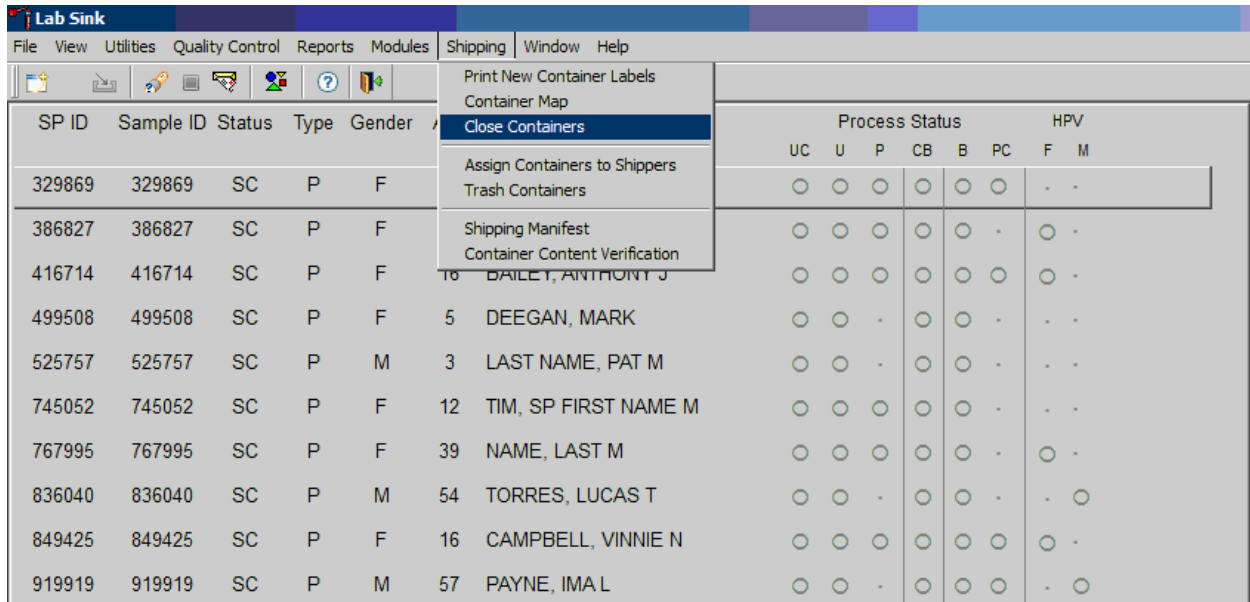

To access the {Close Containers} module, direct the mouse arrow to {Shipping} in the menu bar and left-click, drag the mouse arrow to {Close Containers} and left-click.

This module will be utilized every time the lab ships out any specimens to the testing labs. Close containers, once all the specimens have been processed in the lab for that session. The application defaults to weekly, as the frequency of shipped samples.

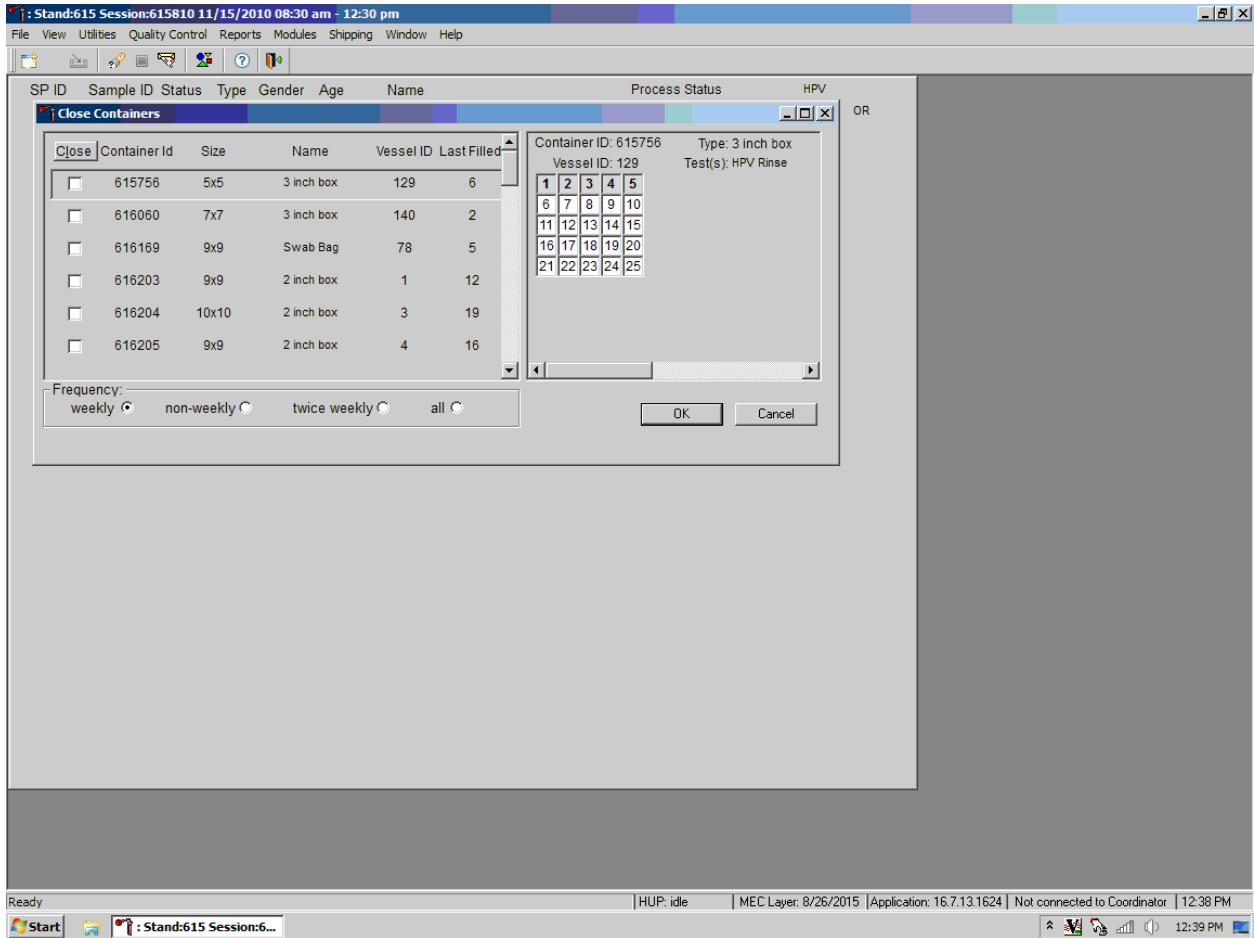

The non-weekly shipping frequency functions show the containers that are shipped when full or at the end of the stand.

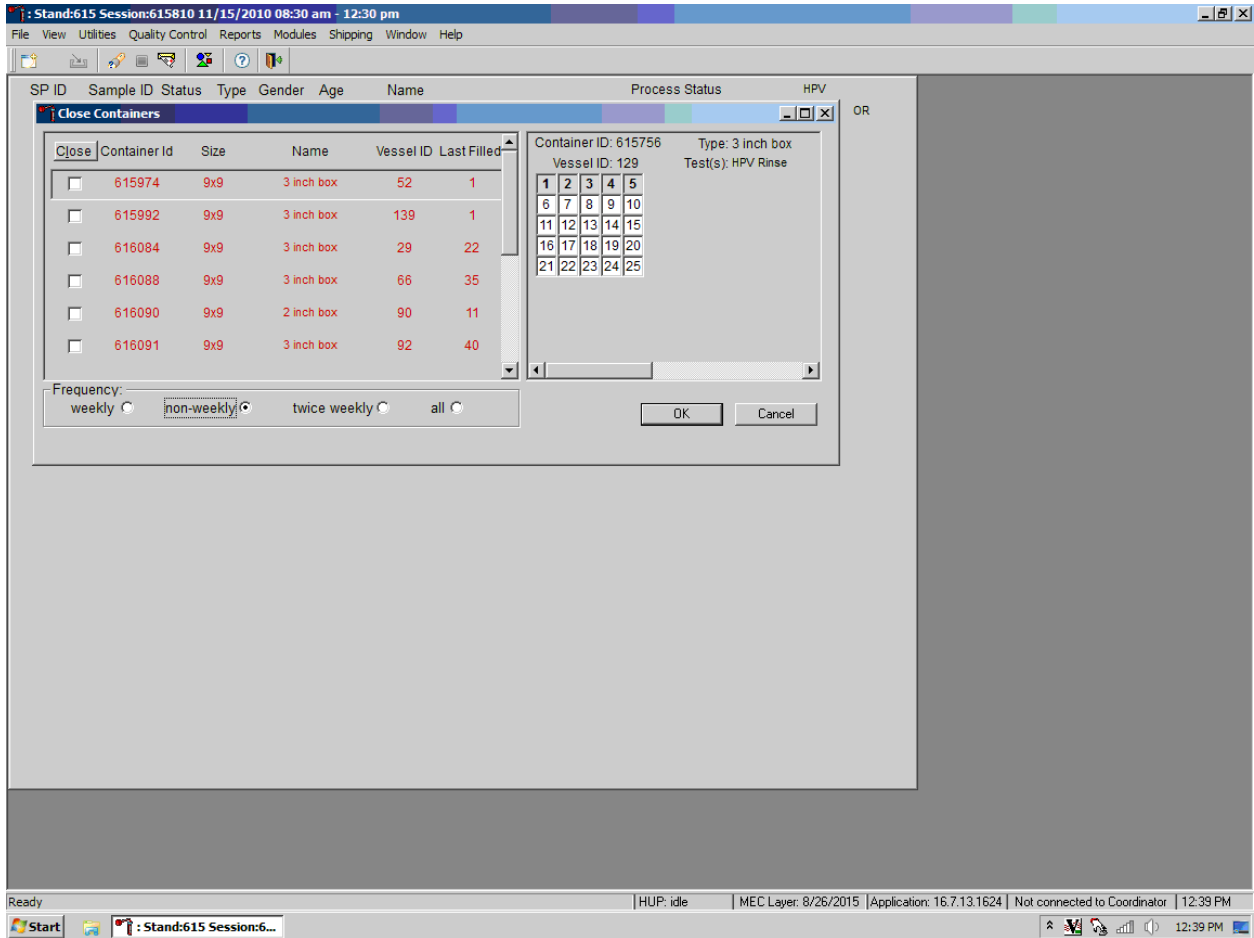

Use this function at the end of the stand, select all to close all the containers to ship out to the testing labs.

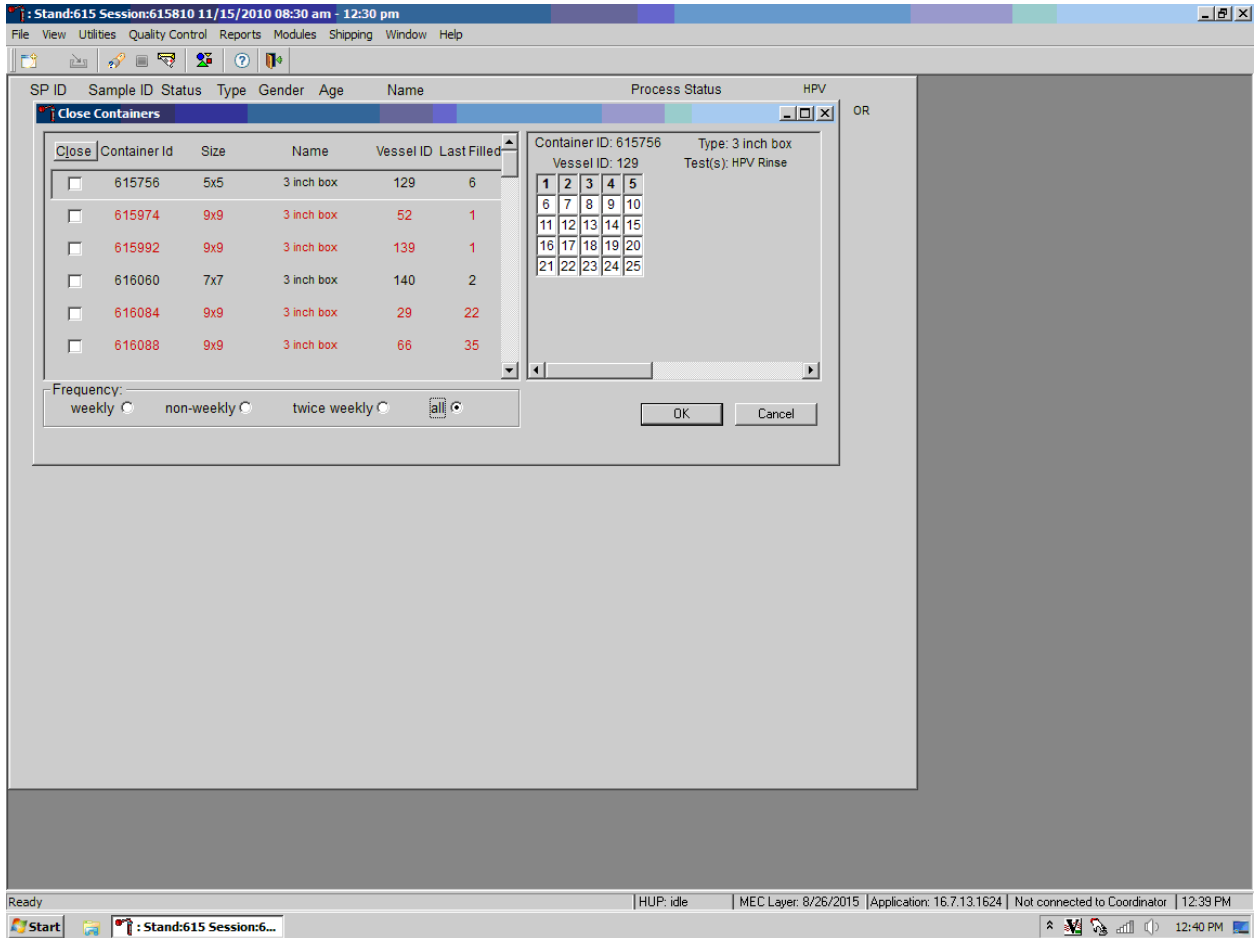

To close the containers, place a checkmark in the “Close” column, which will close these containers in the system so no more samples can be added to these containers.

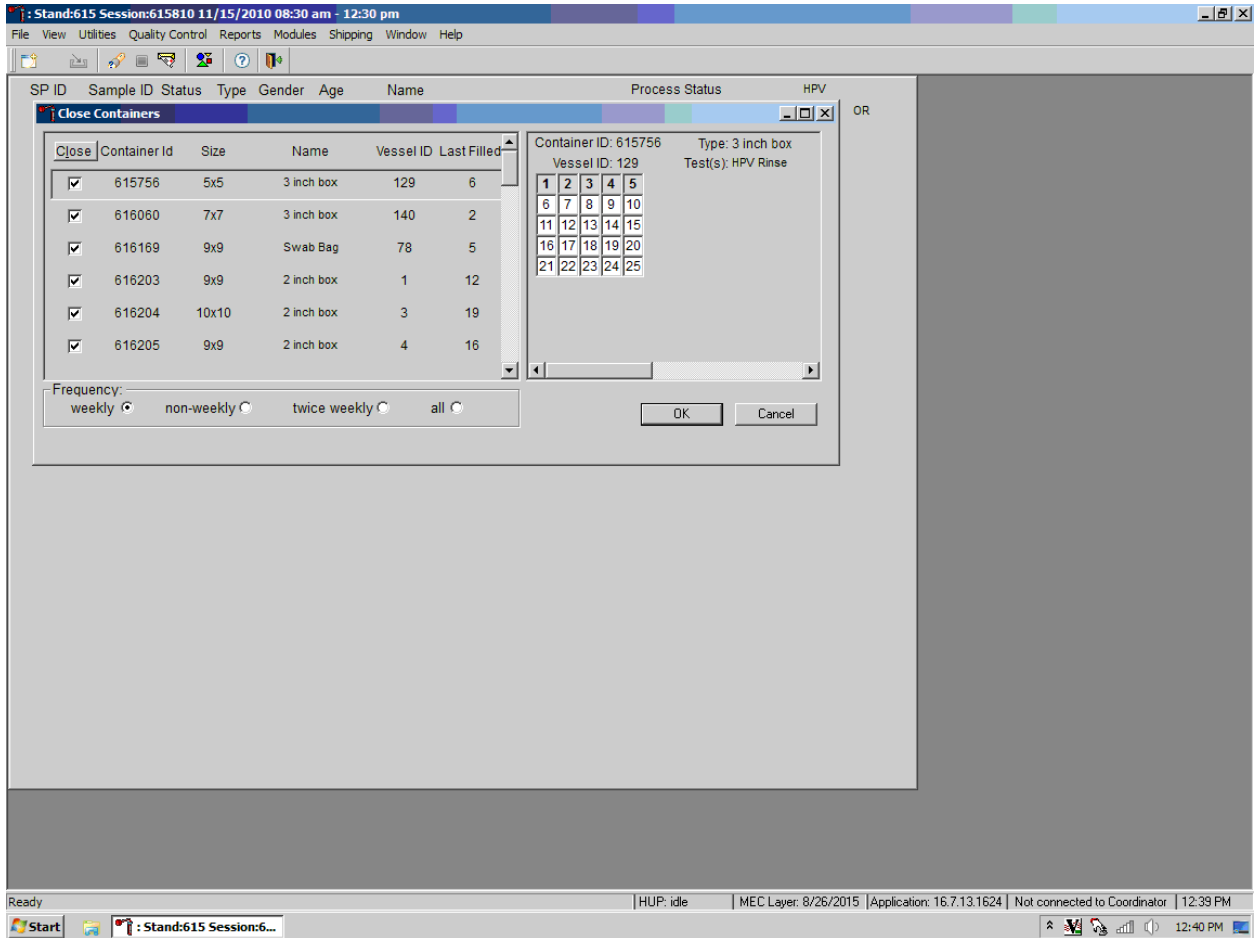

After the containers are closed, a list will be displayed of the containers that need labels printed before any specimens can be put into the new containers.

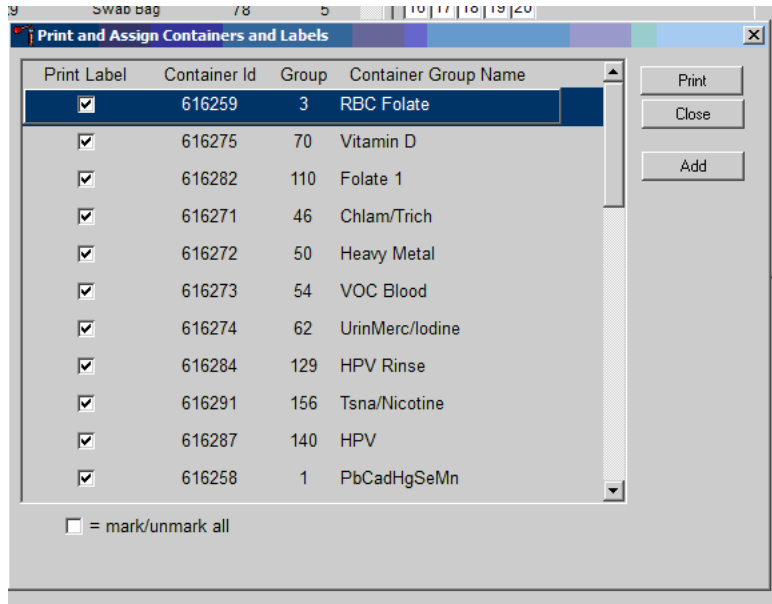

8.6 Trash or Reprint Container Labels

Each stand is allocated a maximum of 999 container IDs.

If unused container labels become lost or damaged, use the Trash Containers module to delete the container IDs. Access the Trash Containers module.

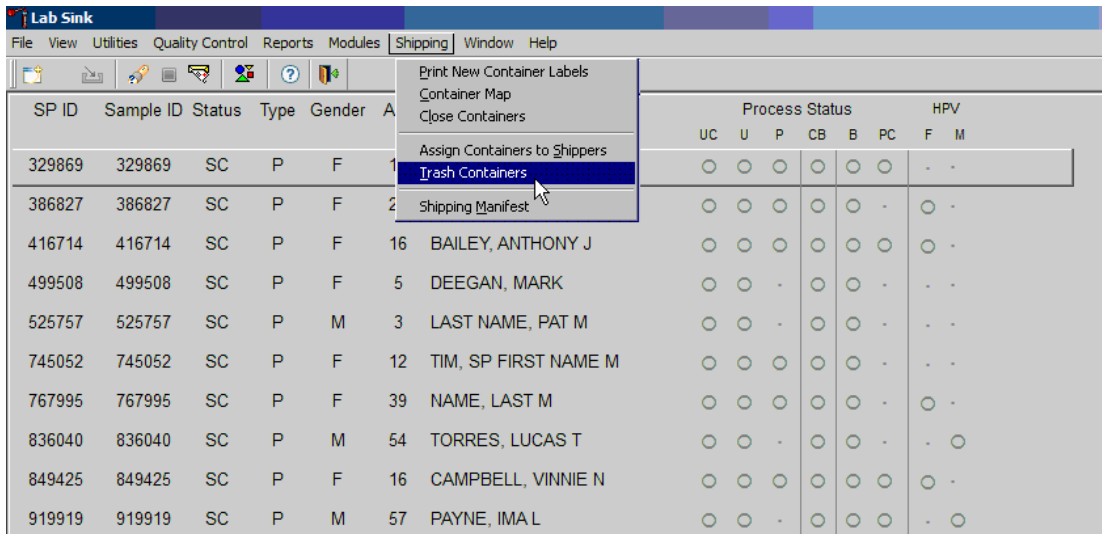

To access the Trash Containers module, direct the mouse arrow to Shipping, left-click, drag the arrow to Trash Containers, and left-click.

The Trash Unused Containers window displays.

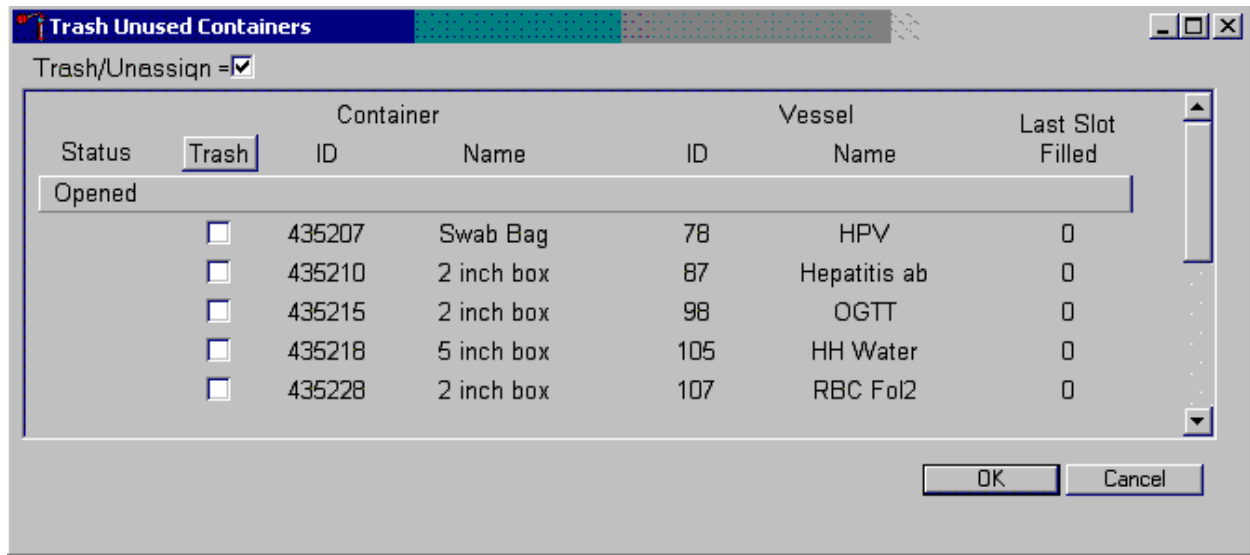

The status of each container ID is “Opened.” To individually mark the container IDs for deletion, direct the mouse arrow to the checkboxes and individually left-click on specific boxes or, to mark all outstanding container IDs for deletion, direct the mouse arrow to the “Trash” button and left-click. To collectively mark ALL containers, direct the mouse arrow to the Trash header and left-click.

As the container IDs are marked for deletion, the status changes from “Opened” to “Trashed.”

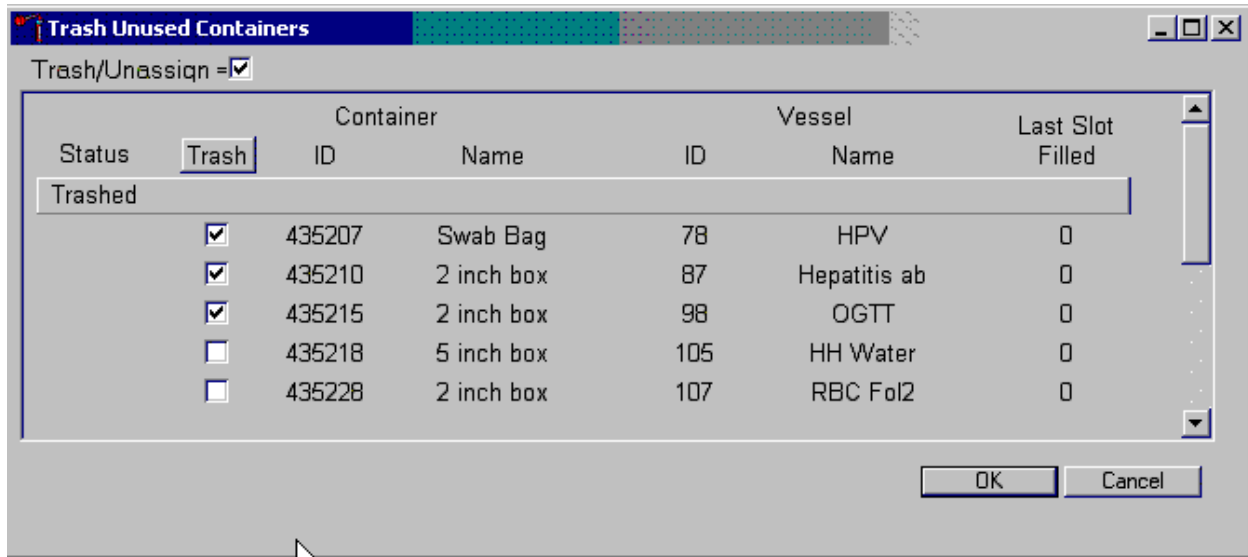

To record these actions and execute the Trash Unused Containers function, direct the mouse arrow to the OK button and left-click, or select Enter. To exit the Trash Unused Containers module without recording or executing the Trash Containers function, direct the mouse arrow to the Cancel button and left-click.

8.6.1 Reprint Container Labels for Existing Containers

Reprint labels for existing, not shipped containers.

Reprinting Container Labels from the Container Map Screen

. Right-click on the Container ID you wish to reprint, select Print Container Label. The label will print to the associated dymo printer.

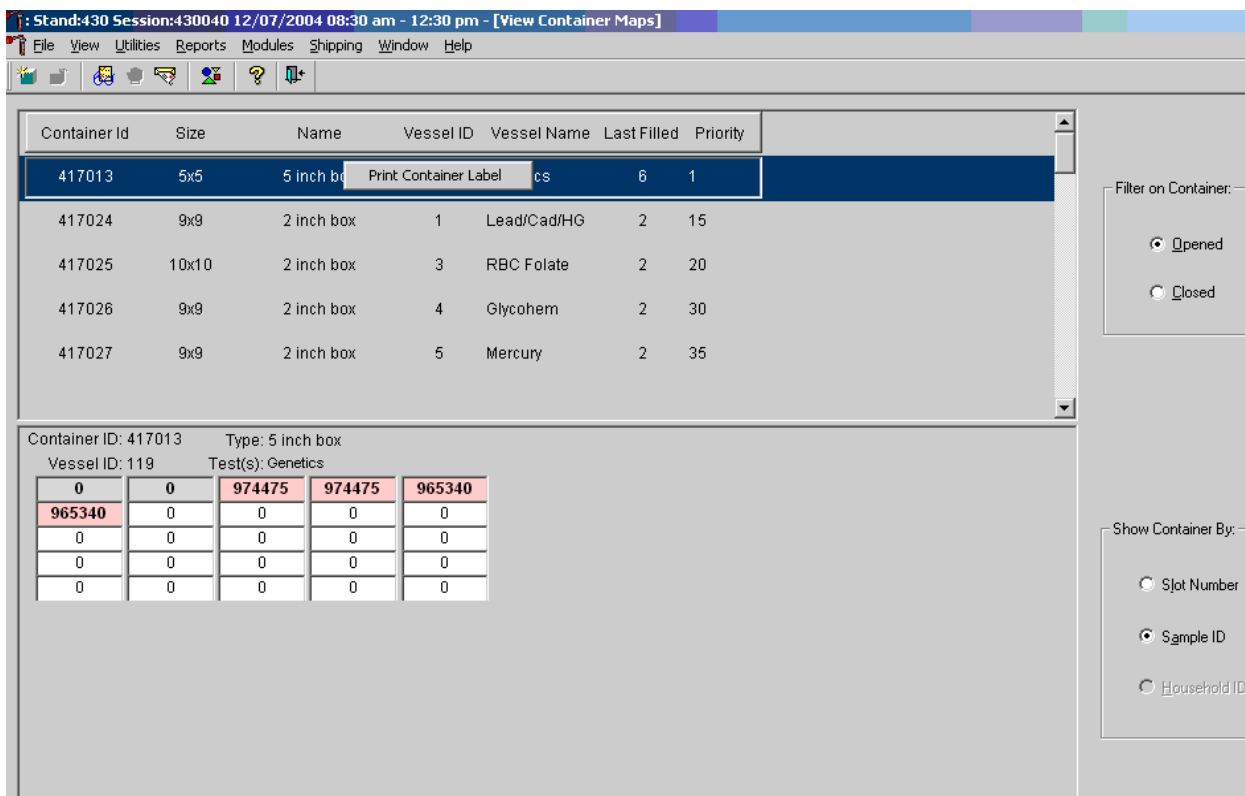

8.7 Shipping Overview

The integrity of laboratory specimens is critical to NHANES. Storage temperatures have been established for each analyte in consultation with the National Center for Health Statistics (NCHS) and contract laboratories. It is critical to maintain these established conditions throughout specimen storage and shipping and until their ultimate receipt by the contract laboratories. Maintain these conditions by using documented procedures, which include using sufficient dry ice, refrigerant packs, and sending specimens by FedEx priority overnight.

FedEx Priority Overnight guarantees next-business-day delivery by 10:30 a.m. to most U.S. addresses and by noon, 4:30 p.m., or 5 p.m. in remote areas. Delivery by FedEx can be delayed due to a weekend or holiday. This extraordinary circumstance usually occurs at the end of a stand or just before vacation. In any case, ship all specimens before vacations. The following actions are intended to mitigate unforeseen delay:

- Consider adding extra dry ice. Use a medium shipper for all international shipments.
- Use dry ice in blocks instead of pellets since blocks sublimate at a slower rate.
- Increase the number of refrigerant packs from four to at least six per shipper.

The shipping technologist is primarily responsible for packing and shipping the specimens to various contract laboratories on a designated day. As necessary, other medical technologists assist in performing each of the steps listed below to complete the shipping procedures.

Prior to the next stand, the laboratory staff creates address labels with the next stand's MEC address to use on the Class 9 labels. Place the next stand's MEC address label in the upper left of the Class 9 label and place the appropriate Lab label in the upper right of the Class 9 label. Enter the appropriate dry ice weight in kilograms (kg) in the blank space next to kg. Trim both labels to fit in the space so they don't cover up any information. Prepare Class 9 labels with the MEC address and Lab address for each shipping week.

Shipping Procedures:

- Create airbill return packets.
- Create airbills before designated shipping day.

- Retrieve Class 9', Keep Frozen and Refrigerated labels.
- Close containers and print new container labels when session prior to shipping is complete.
- Print shipping manifest and place in the airbill return packet.
- Collect the shippers from the compartments under the MEC.
- Pack the shippers with the containers, absorbent material, newsprint (padding), plastic bags, and a sufficient supply of dry ice or refrigerant packs as appropriate.

Place the appropriate paper manifest into the preprinted FedEx return airbill packet and place the plastic bag on top of the Styrofoam shipper lid.

- Label each shipper with the appropriate FedEx label and shipping labels.
- Call Fedex for pickup.
- When the contract laboratory personnel receive the shippers, they unpack the specimens and return the shippers and refrigerant packs to the warehouse.

8.8 Assign Containers to Shippers

Assign closed containers to or associate closed containers with a specific airbill. To associate a specific closed container to the airbill for that laboratory, use the Assign Container to Shippers module.

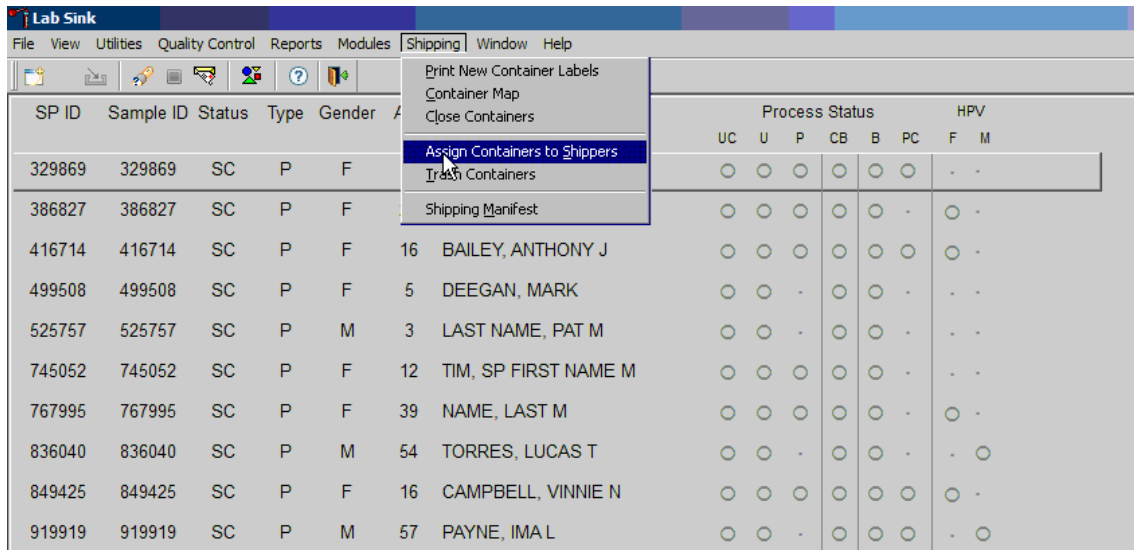

To access the Assign Containers to Shippers module, direct the mouse arrow to Shipping in the top menu bar, left-click, drag the mouse arrow to Assign Container to Shippers, and left-click.

The Assign Containers to Shippers window displays.

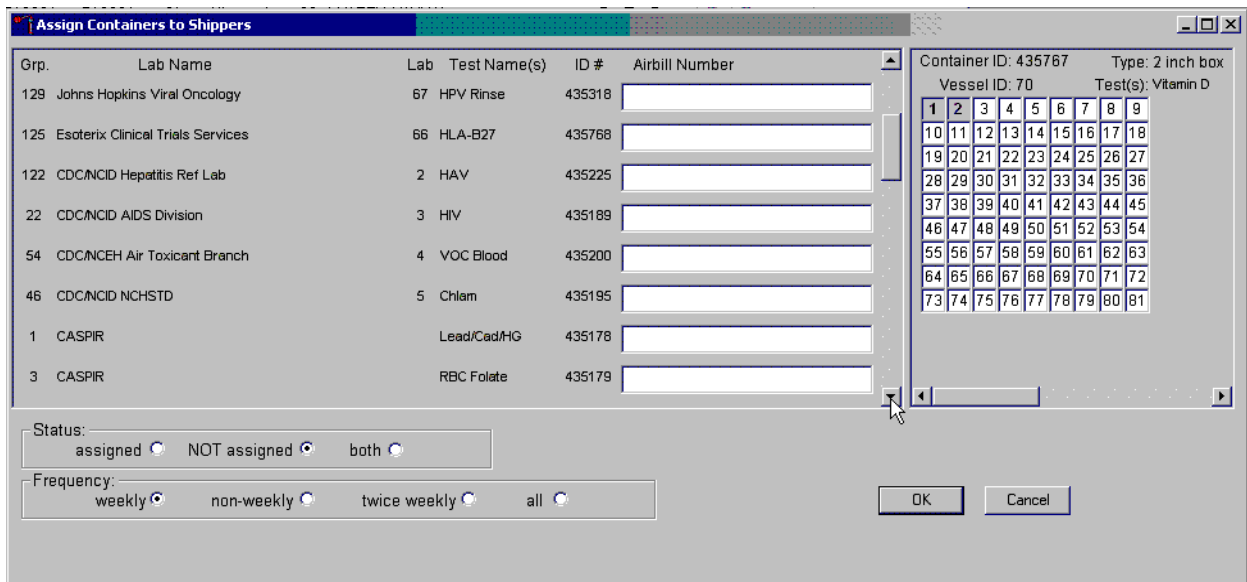

This left side of the screen includes columns for a group designation (which represents a Vessel ID), Lab designation, Test Name(s), Container ID number, and Airbill Number. The container line within the rectangular box is the active container. The right side of the screen displays the corresponding container map for the active container. The left side of the bottom of the window

contains three “Status” filters (radio buttons): “assigned,” “NOT assigned,” and “both.” The second line on left side of the bottom of the window contains three “Frequency” filters (radio buttons): “weekly,” “non-weekly,” “twice weekly,” and “all.” Use the column titles to sort the rows. To sort the rows, direct the mouse arrow to the desired column title and left-click. The window updates based on the selection.

Enter an airbill number into each Airbill Number text box. Ensure the cursor is in the left side of the text box. There are three ways to enter the airbill number:

- Use the barcode gun to scan the barcode from the FedEx Ship Manager airbill. The barcode is located in the bottom of the top half of the folded airbill. It is the tallest on the airbill. Hold the gun in the right hand, squeeze the trigger, and move the gun up and down to adjust the laser light so that it covers the width of the barcode. Once the gun successfully scans the barcode, an audible beep is emitted.
- Use the barcode gun to scan the barcode on the second page (Recipient’s Copy) of the two-part Form ID 0215. This barcode is located on the lower left-hand side toward the bottom of the form. Hold the gun in the right hand, squeeze the trigger, and move the gun up and down to adjust the laser light so that it covers the width of the barcode. Once the gun successfully scans the barcode, an audible beep is emitted.
- Use the keyboard keys to type the airbill number from either the FedEx Ship Manager airbill or the FedEx airbill form 0215.

To assign a container to the corresponding airbill:

- Set the Status filter to: “NOT assigned”; and
- Set the Frequency to: weekly, non-weekly, or both, depending on the shipping situation.

Set the Status and Frequency filters.

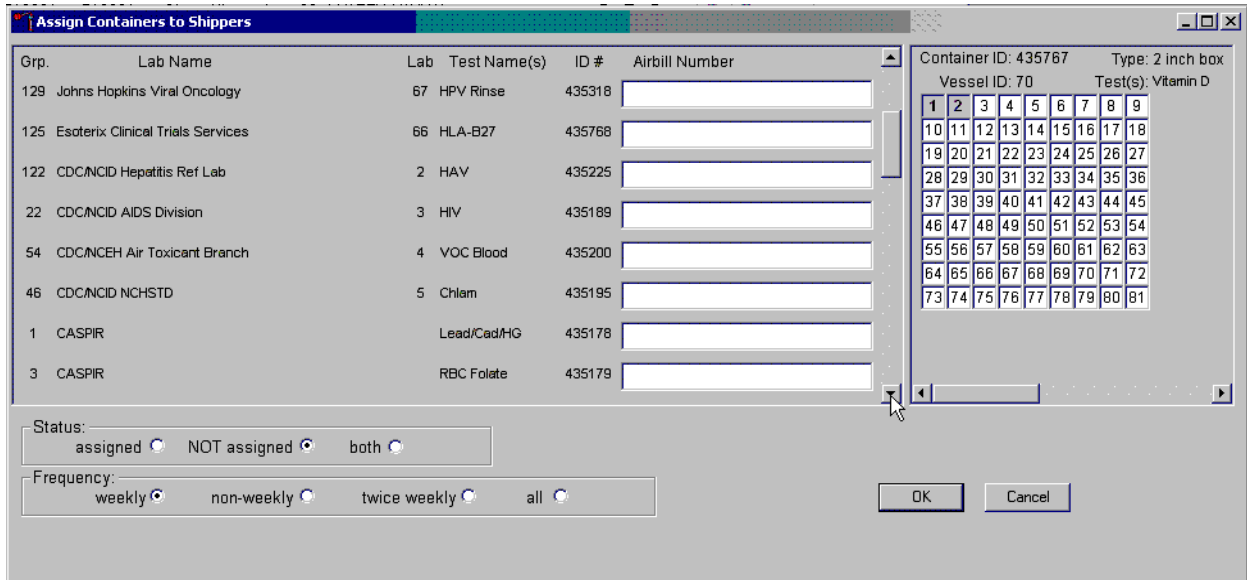

To select the Status filter, direct the mouse arrow to the “assigned,” “NOT assigned,” or “both,” radio button and left-click. To select the shipping Frequency, direct the mouse arrow to weekly, non-weekly, twice weekly, or all, and left-click.

Sort the rows by Lab Name.

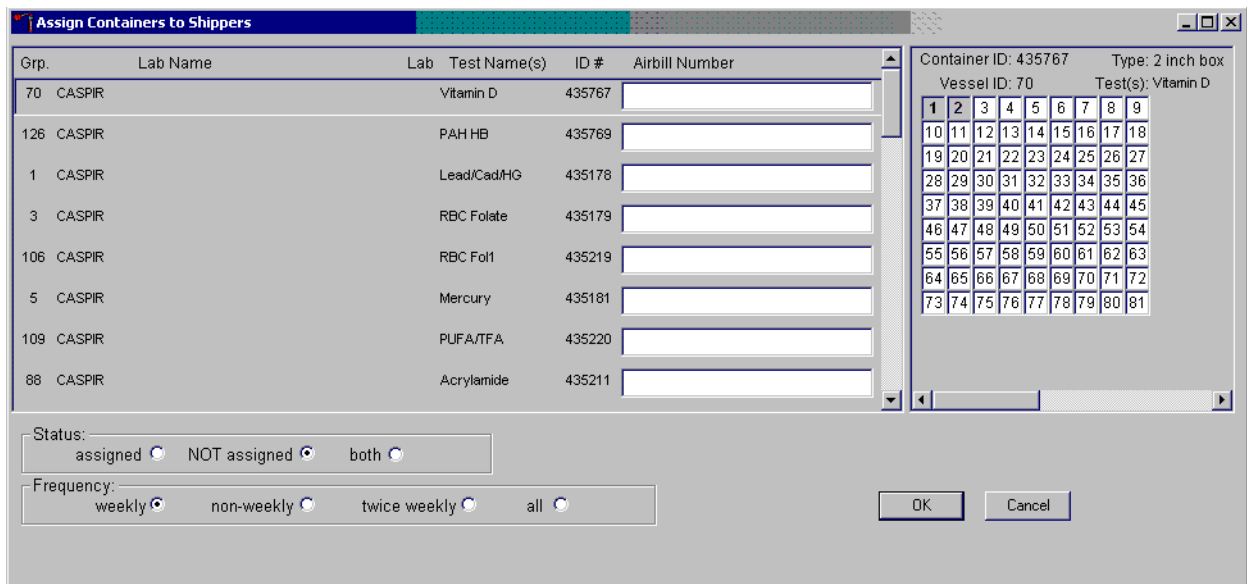

To sort the rows by lab Name, direct the mouse arrow to the top header “Lab Name” and left-click. All containers associated with a specific lab will be grouped together in ascending order.

Click on the left side of the airbill number to activate the cursor. Enter the airbill number into the Airbill Number text box.

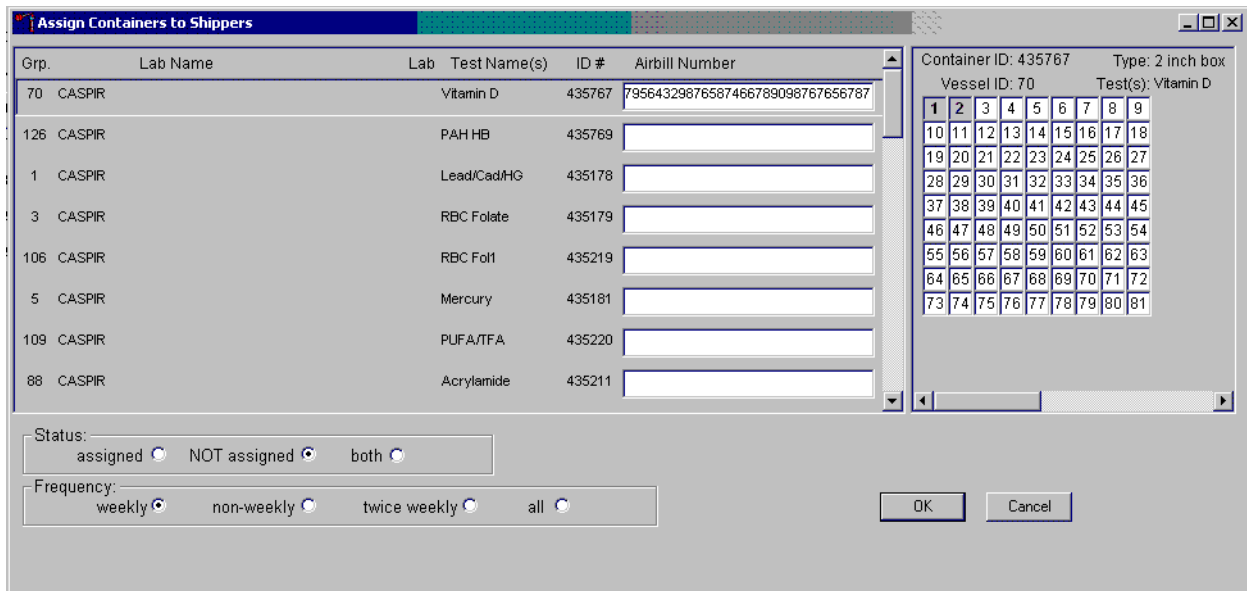

Use the barcode gun to scan the airbill number. The scanned number contains 20 extra digits. The actual 12-digit airbill number is embedded in the 32-digit scanned number. Select the Tab key to move to the next text box. Do not select the Tab key until the application has been allowed to enter the entire number into the text box. Once the Tab key is selected, the program edits the first airbill number to delete the extra numbers.

Continue the assignment process.

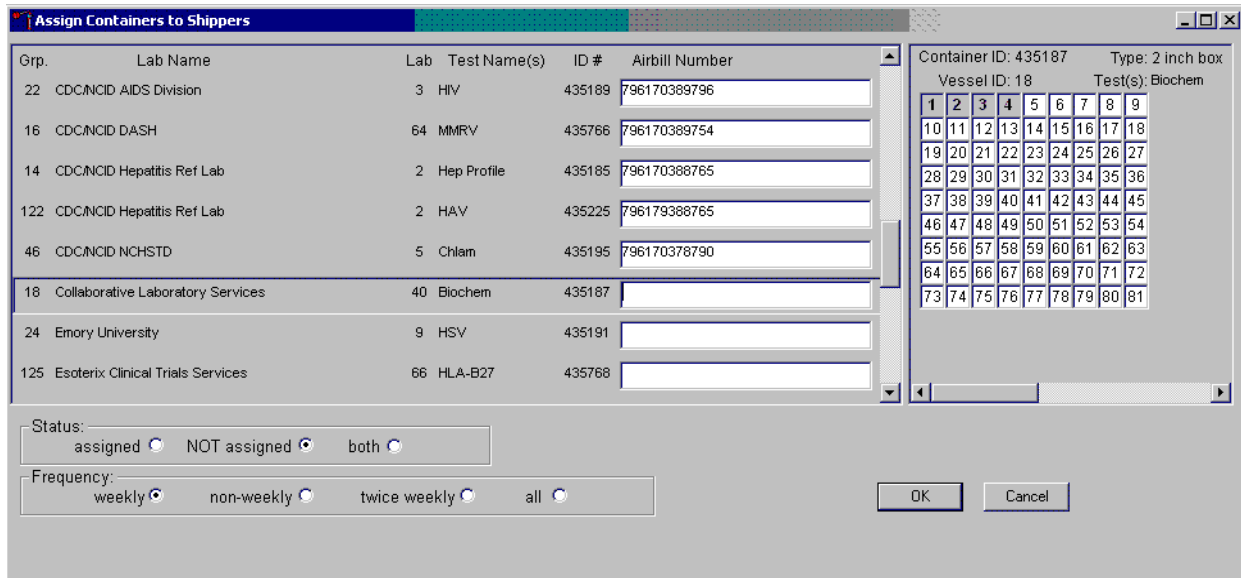

Continue scanning the barcodes and selecting the Tab key until all closed containers are assigned to airbills.

Complete the assignment process.

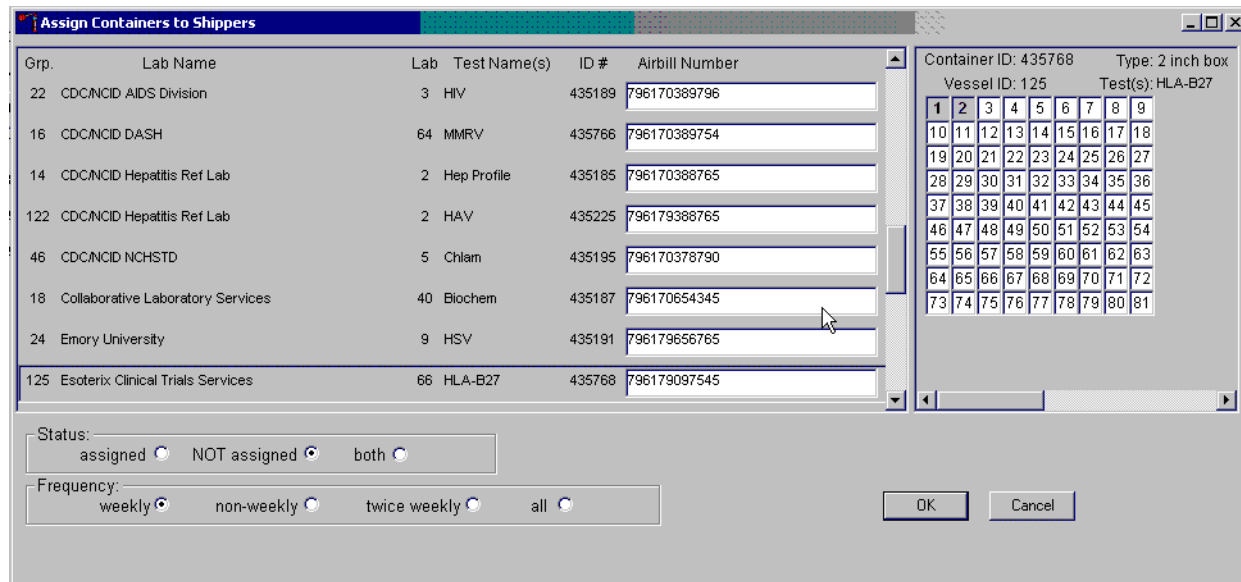

To record the assignment of containers to shippers, direct the mouse arrow to the OK button and left-click. **This step is required to save the information.** To exit the Assign Containers to

Shippers module without recording any assignments, direct the mouse arrow to the Cancel button and left-click.

8.9 Create Shipping Manifests

Each shipper must include a paper manifest, which lists the inventory of the specimens in the shipping boxes. In addition, each laboratory receives an identical electronic file. Follow the steps listed below to prepare the paper manifest and to send the electronic file.

Access the Shipping Manifest module.

The screenshot shows the 'Lab Sink' application window. The 'Shipping' menu is open, displaying options: 'Print New Container Labels', 'Container Map', 'Close Containers', 'Assign Containers to Shippers', 'Trash Containers', and 'Shipping Manifest'. The 'Shipping Manifest' option is highlighted. Below the menu is a table with columns for specimen information and process status.

SP ID	Sample ID	Status	Type	Gender	A	Process Status							
						UC	U	P	CB	B	PC	F	M
329869	329869	SC	P	F		<input type="radio"/>	<input type="radio"/>	<input type="radio"/>	<input type="radio"/>	<input type="radio"/>	<input type="radio"/>	-	-
386827	386827	SC	P	F		<input type="radio"/>	<input type="radio"/>	<input type="radio"/>	<input type="radio"/>	<input type="radio"/>	-	<input type="radio"/>	-
416714	416714	SC	P	F	16	BAILEY, ANTHONY J	<input type="radio"/>	<input type="radio"/>	<input type="radio"/>	<input type="radio"/>	<input type="radio"/>	<input type="radio"/>	-
499508	499508	SC	P	F	5	DEEGAN, MARK	<input type="radio"/>	<input type="radio"/>	-	<input type="radio"/>	<input type="radio"/>	-	-
525757	525757	SC	P	M	3	LAST NAME, PAT M	<input type="radio"/>	<input type="radio"/>	-	<input type="radio"/>	<input type="radio"/>	-	-
745052	745052	SC	P	F	12	TIM, SP FIRST NAME M	<input type="radio"/>	<input type="radio"/>	<input type="radio"/>	<input type="radio"/>	<input type="radio"/>	-	-
767995	767995	SC	P	F	39	NAME, LAST M	<input type="radio"/>	<input type="radio"/>	<input type="radio"/>	<input type="radio"/>	<input type="radio"/>	-	<input type="radio"/>
836040	836040	SC	P	M	54	TORRES, LUCAS T	<input type="radio"/>	<input type="radio"/>	-	<input type="radio"/>	<input type="radio"/>	-	<input type="radio"/>
849425	849425	SC	P	F	16	CAMPBELL, VINNIE N	<input type="radio"/>	<input type="radio"/>	<input type="radio"/>	<input type="radio"/>	<input type="radio"/>	<input type="radio"/>	-
919919	919919	SC	P	M	57	PAYNE, IMA L	<input type="radio"/>	<input type="radio"/>	-	<input type="radio"/>	<input type="radio"/>	-	<input type="radio"/>

To access the Shipping Manifest module, direct the mouse arrow to Shipping in the top menu bar, left-click, drag the mouse arrow to Shipping Manifest, and left-click

A Shipping Manifest window displays either after the Shipping Manifest module is accessed or after a positive response is recorded to the IC Informed Consent Exclusion window.

The screenshot shows a software window titled "Shipping Manifest". At the top, there is a "Filter:" section with two radio buttons: "Unprocessed" (selected) and "Previously Processed". Below this is a table with columns: "Mark for Processing", "Airbill Number", "Shipment Date", and "Ship to Lab".

Mark for Processing	Airbill Number	Shipment Date	Ship to Lab
<input type="checkbox"/>	796170388765	12/11/2008	CDC/NCID Hepatitis Ref Lab (2)
<input type="checkbox"/>	796179388765	12/11/2008	CDC/NCID Hepatitis Ref Lab (2)
<input type="checkbox"/>	796170389796	12/11/2008	CDC/NCID AIDS Division (3)

Below the table is a checkbox labeled "= mark/unmark all". To the right of the table are "Process" and "Close" buttons.

The lower portion of the window displays a shipping label for the "DEPARTMENT OF HEALTH AND HUMAN SERVICES" and "Centers for Disease Control and Prevention". The label includes the "National Health and Nutrition Examination Survey" logo and text, and a "Shipping Manifest Report" with a barcode.

Below the label is a detailed report with the following information:

- Shipment ID: 796170388765
- Shipment Date: 12/11/2008
- Survey Year: 2007
- Lab Name: CDC/NCID Hepatitis Ref Lab
- Lab ID: 2
- Address: 1600 Clifton Road, Bldg 18 Floor 3 Rm 218 MS A33, Atlanta, GA 30329
- Contact: Annemarie Wasley
- Phone: (404)639-3103
- E-Mail:

At the bottom, there is a table with columns: "Container Id", "Size", "Type", "Test(s)", and "Hep Profile".

Container Id	Size	Type	Test(s)	Hep Profile
435185	9x9	2 inch box		Hep Profile

Below this is another table with columns: "Slot Id", "Sample/Vessel Id", "Astro Id", "Date Collected", and "Age Group".

Slot Id	Sample/Vessel Id	Astro Id	Date Collected	Age Group
1	184869014	0000KW0A	10/20/2008	2
2	312716014	0000KWVS	12/9/2008	2
3	244969014	0000KWBP	12/10/2008	2

The upper portion of the Shipping Manifest Report contains two filters “Unprocessed” and “Previously Processed” and one row for each airbill assigned in the Assign Container to Shipper module. The row includes a Mark for Processing checkbox, the Airbill Number, Shipment Date, and Ship to Lab ID, and one checkbox to mark or unmark all airbills.

The lower portion of the window includes the Shipment ID or airbill number, Shipment Date, Lab Name, Lab ID number, Address, Contact personnel, Survey Year, Container ID associated with the shipment ID, container Size, container Type, Test(s) associated with the container, and a list by Slot ID of the Sample/Vessel ID, Astro ID, and Date Collected.

Select one of the filters.

Filter: Unprocessed Previously Processed

Mark for Processing	Airbill Number	Shipment Date	Ship to Lab
<input type="checkbox"/>	796170388765	12/11/2008	CDC/NCID Hepatitis Ref Lab (2)
<input type="checkbox"/>	796179388765	12/11/2008	CDC/NCID Hepatitis Ref Lab (2)
<input type="checkbox"/>	796170389796	12/11/2008	CDC/NCID AIDS Division (3)

= mark/unmark all

DEPARTMENT OF HEALTH AND HUMAN SERVICES
Centers for Disease Control and Prevention
National Health and Nutrition Examination Survey
National Center for Health Statistics
3311 Toledo Road, Rm 4323
Hyattsville, Maryland 20782

Shipping Manifest Report

Shipment ID: 796170388765 Survey Year: 2007
Shipment Date: 12/11/2008

Lab Name: CDC/NCID Hepatitis Ref Lab Lab ID: 2
Address: 1600 Clifton Road Bldg 18 Floor 3 Rm 218 MS A33 Atlanta, GA 30329
Contact: Annemarie Wasley Phone: (404)639-3103 E-Mail:

Container Id:	Size:	Type:	Test(s):
435185	9x9	2 inch box	Hep Profile

Slot Id	Sample/Vessel Id	Astro Id	Date Collected	Age Group
1	184869014	000OKW0A	10/20/2008	2
2	312716014	000OKWVS	12/9/2008	2
3	244969014	000OKWBP	12/10/2008	2

Set the filter to “Unprocessed” to print manifests and generate email files for shipments created but not previously processed using this module. Set the filter to “Previously Processed” to reprint an airbill or to re-create an electronic file for shipments previously processed using this module. To filter on unprocessed airbills, direct the mouse arrow to the “Unprocessed” radio button and left-click. To filter on previously processed airbills, direct the mouse arrow to the “Previously Processed” radio button and left-click.

Select one or more manifests by placing a checkmark in the Mark for Processing checkboxes.

Filter: Unprocessed Previously Processed

Mark for Processing	Airbill Number	Shipment Date	Ship to Lab
<input checked="" type="checkbox"/>	796170388765	12/11/2008	CDC/NCID Hepatitis Ref Lab (2)
<input checked="" type="checkbox"/>	796179388765	12/11/2008	CDC/NCID Hepatitis Ref Lab (2)
<input type="checkbox"/>	796170389796	12/11/2008	CDC/NCID AIDS Division (3)

= mark/unmark all

DEPARTMENT OF HEALTH AND HUMAN SERVICES
Centers for Disease Control and Prevention
National Health and Nutrition Examination Survey
National Center for Health Statistics
3311 Toledo Road, Rm 4323
Hyattsville, Maryland 20782

Shipping Manifest Report

Shipment ID: 796170388765 Survey Year: 2007
Shipment Date: 12/11/2008

Lab Name: CDC/NCID Hepatitis Ref Lab Lab ID: 2
Address: 1600 Clifton Road Contact: Annemarie Wasley
Bldg 18 Floor 3 Rm 218 MS A33 Phone: (404)639-3103
Atlanta, GA 30329 E-Mail:

Container Id: 435185	Size: 9x9	Type: 2 inch box	Test(s):	Hep Profile
Slot Id	Sample/Vessel Id	Astro Id	Date Collected	Age Group
1	184869014	0000KW0A	10/20/2008	2
2	312716014	0000KW0S	12/9/2008	2
3	244969014	0000KW0P	12/10/2008	2

To select or mark one manifest for printing and email, direct the mouse arrow to the checkbox and left-click. Repeat this process to include other airbills. Use the scroll bar to display all existing airbills. The lower portion of the window updates to display only marked airbills.

Collectively mark or unmark all the airbills.

Filter: Unprocessed Previously Processed

Mark for Processing	Airbill Number	Shipment Date	Ship to Lab
<input checked="" type="checkbox"/>	796170388765	12/11/2008	CDC/NCID Hepatitis Ref Lab (2)
<input checked="" type="checkbox"/>	796179388765	12/11/2008	CDC/NCID Hepatitis Ref Lab (2)
<input checked="" type="checkbox"/>	796170389796	12/11/2008	CDC/NCID AIDS Division (3)

mark/unmark all

DEPARTMENT OF HEALTH AND HUMAN SERVICES
Centers for Disease Control and Prevention
National Health and Nutrition Examination Survey
National Center for Health Statistics
3311 Toledo Road, Rm 4323
Hyattsville, Maryland 20782

Shipping Manifest Report

Shipment ID: 796170388765 Survey Year: 2007
Shipment Date: 12/11/2008

Lab Name: CDC/NCID Hepatitis Ref Lab Lab ID: 2

Address: 1600 Clifton Road
Bldg 18 Floor 3 Rm 218 MS A33
Atlanta, GA 30329

Contact: Annemarie Wasley
Phone: (404)639-3103
E-Mail:

Container Id	Size	Type	Test(s)	Hep Profile
435185	9x9	2 inch box		

Slot Id	Sample/Vessel Id	Astro Id	Date Collected	Age Group
1	184869014	000OKW0A	10/20/2008	2
2	312716014	000OKWVS	12/9/2008	2
3	244969014	000OKWBP	12/10/2008	2

To collectively mark all the airbills, direct the mouse arrow to the mark/unmark all checkbox and left-click. To collectively unmark all the airbills, direct the mouse arrow to the mark/unmark all checkbox and left-click a second time. The lower portion of the screen will update to display the marked airbills.

The right side of the window includes two buttons: Process and Close. Process the shipping manifests using the “Process” button.

Filter: Unprocessed Previously Processed

Mark for Processing	Airbill Number	Shipment Date	Ship to Lab
<input checked="" type="checkbox"/>	796170388765	12/11/2008	CDC/NCID Hepatitis Ref Lab (2)
<input checked="" type="checkbox"/>	796179388765	12/11/2008	CDC/NCID Hepatitis Ref Lab (2)
<input checked="" type="checkbox"/>	796170389796	12/11/2008	CDC/NCID AIDS Division (3)

mark/unmark all

DEPARTMENT OF HEALTH AND HUMAN SERVICES
Centers for Disease Control and Prevention
National Health and Nutrition Examination Survey
National Center for Health Statistics
3311 Toledo Road, Rm 4323
Hyattsville, Maryland 20782

Shipping Manifest Report

Shipment ID: 796170388765 Survey Year: 2007
Shipment Date: 12/11/2008

Lab Name: CDC/NCID Hepatitis Ref Lab	Lab ID: 2
Address: 1600 Clifton Road Bldg 18 Floor 3 Rm 218 MS A33 Atlanta, GA 30329	Contact: Annemarie Wasley Phone: (404)639-3103 E-Mail:

Container Id	Size	Type	Test(s)
435185	9x9	2 inch box	Hep Profile

Slot Id	Sample/Vessel Id	Astro Id	Date Collected	Age Group
1	184869014	000OKW0A	10/20/2008	2
2	312716014	000OKWVS	12/9/2008	2
3	244969014	000OKWBP	12/10/2008	2

Selecting the “Process” button will generate and print the Shipping Manifest Report(s). To print the manifests, direct the mouse arrow to the Process button and left-click. To exit the module without printing the manifest, direct the mouse arrow to the “Close” button and left-click.

8.10 Informed Consent Exclusions

The Informed Consent Exclusions window displays either when the Close Container or Shipping Manifest module is accessed. It displays when the following conditions have been met:

1. SPs initially signed their consent form, thereby agreeing to have their samples tested for HIV, HPV, and STD testing;
2. They consent to have their vessels stored for future research;
3. They subsequently revoke either consent; and
4. The associated vessels have already been processed.

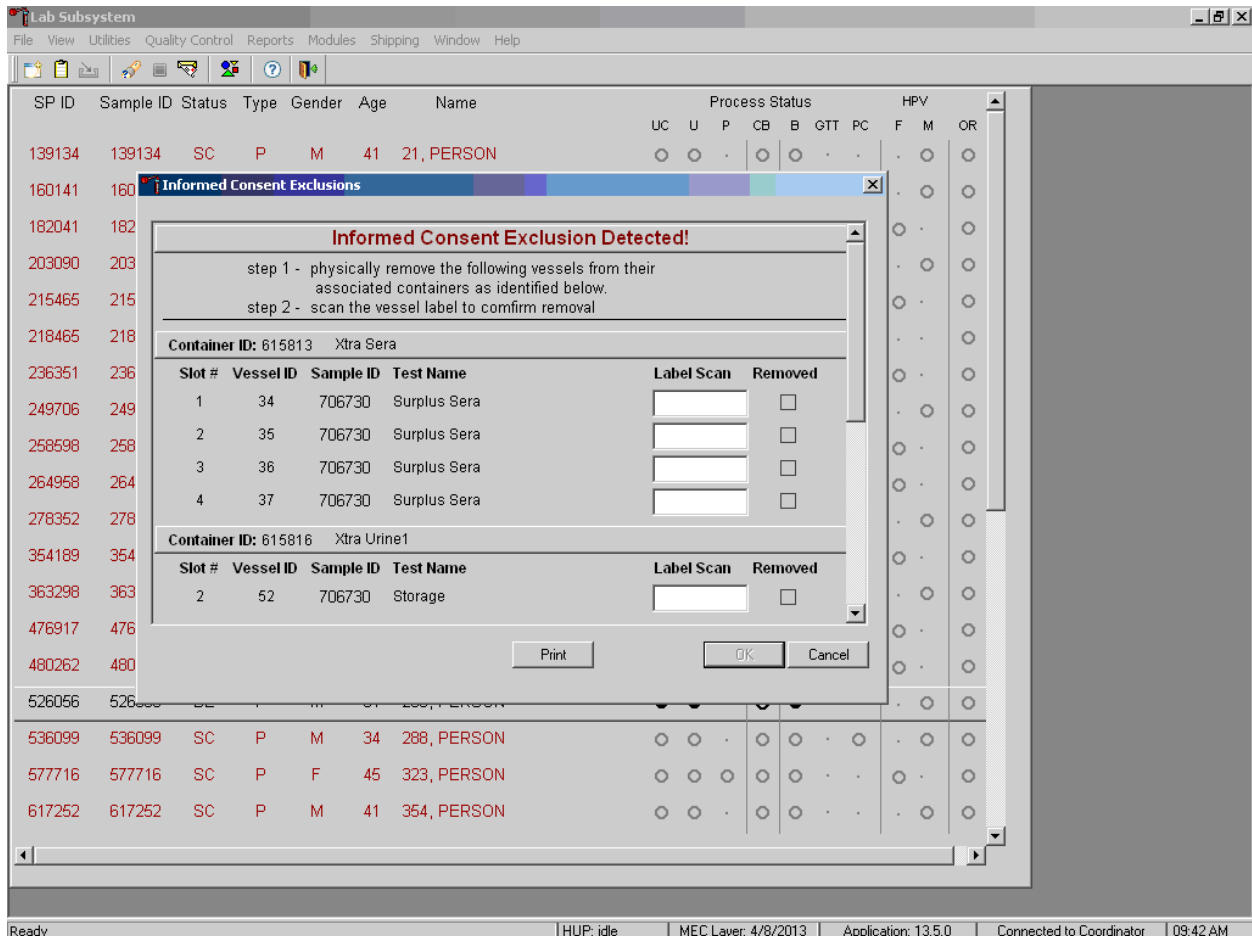

The window contains two steps that must be taken in order to resolve the inconsistencies. It includes the specific container ID and slot number within the container where the vessels are located, the sample ID, and the test name. Each row represents a vessel that must be marked as removed by scanning the barcode of that sample, which will place an “x” in the removed checkbox. A “Print” button on the bottom of the screen allows the list to be printed.

These vessels must be removed from the container and destroyed before the container is shipped. Follow the **exact** instructions indicated in the window—“Physically remove the following vessels from their associated containers as identified below.”

Affirm the actions taken to resolve these exclusions.

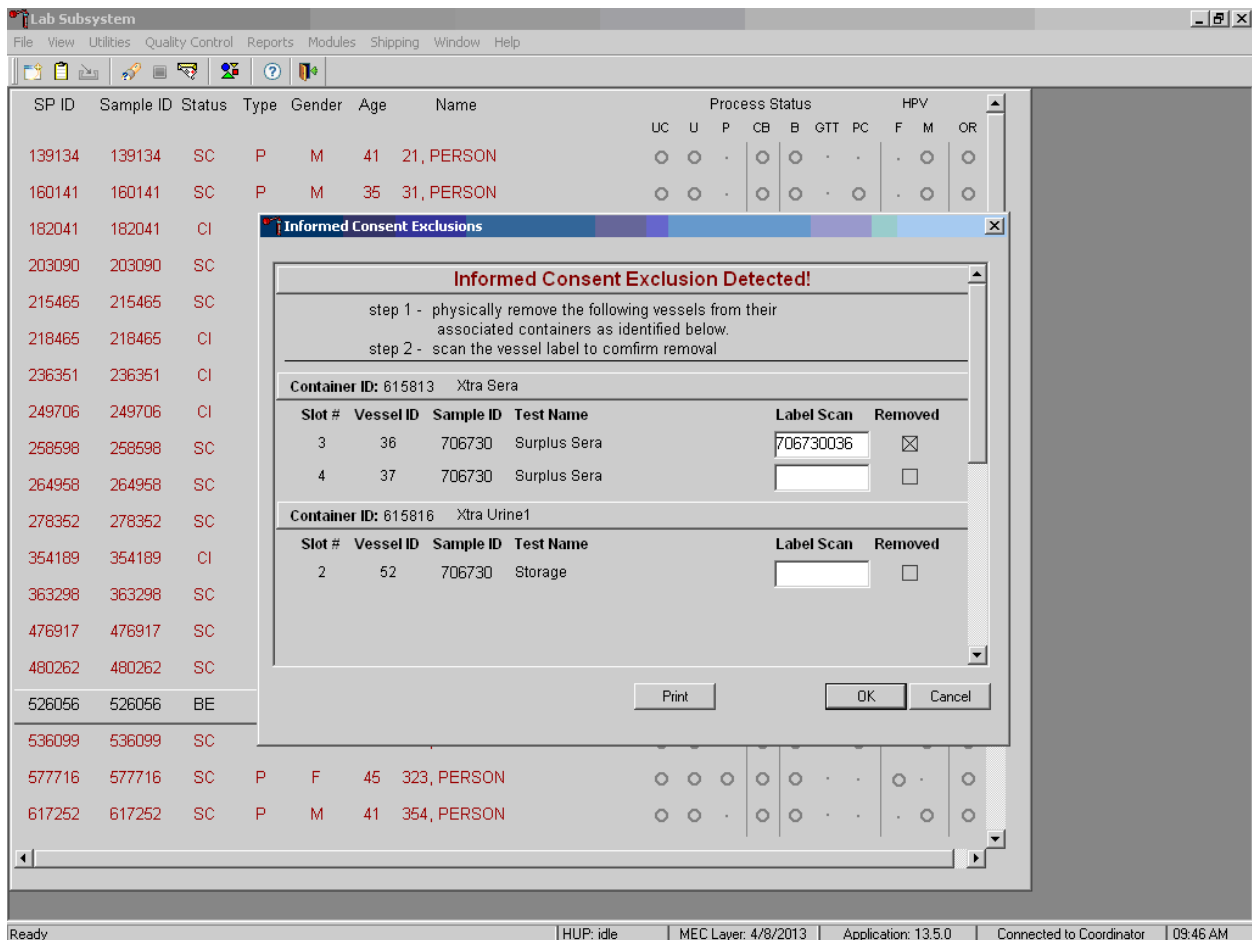

After following the exact instructions displayed in the window, record the actions taken to resolve the exclusions. To record these actions, use the barcode gun and scan the barcode for the tube to be removed. This will place an “x” in the removed checkboxes for all the tubes scanned. To record

these actions in the database and to close the Informed Consent Exclusion window, direct the mouse arrow to the OK button and left-click, or select [Enter]. To remove the window and exit without saving the actions to the database, direct the mouse arrow to the Cancel button and left-click.

If all the vessels are not marked, then an Informed Consent Exclusions for Stand XXX warning pop-up box displays.



The system tracks each vessel in the Informed Consent Exclusion module to ensure that every vessel is marked as removed. Follow the instructions in the pop-up box: “Please physically remove these containers and mark them removed before proceeding.” To acknowledge the message, direct the mouse arrow to the OK button and left-click, or type Enter.

8.11 Packing Procedure for the Shippers

Most of the shipments require dry ice to keep the specimens frozen during shipment. Some shipments require reusable refrigerant packs to keep specimens cold but not frozen. Store reusable refrigerant packs in the freezers. (Distribute the refrigerant packs across all freezers if space is limited.) The FES will make contact with the local dry ice manufacturer and place the order for dry ice delivery, giving the specific weekly dates for delivery. It is the chief medical technologist’s responsibility to confirm with the FES the amount and dates of delivery of dry ice pellets or blocks for shipping specimens. Use sliced blocks whenever possible since these sublimate less than pellets. Store the dry ice in the large blue insulated container provided by the dry ice facility. When handling dry ice, wear cryo gloves to avoid burning hands. Also, wear an eye shield when filling bags with ice chips or breaking blocks into chunks. Exhibit 8-3 is a list of all contract laboratory addresses.

Exhibit 8-3. Contract laboratory addresses

Laboratory/destination specimen shipment address	Vessels/assays	Conditions	Contact name Telephone number
Lab 2 CDC/NCID Hepatitis Ref Lab Attn: Jan Drobeniuc 1600 CLIFTON RD Bldg. 18 Floor 3 Rm. 218 MS A33 Atlanta, GA 30329-4018 404-639-3103	122 - HIV 87 - Hepatitis B _s ab	Frozen	Jan Drobeniuc 404-639-3103
Lab 3 CDC/NCID AIDS Division Attn: Tim Granade 1600 Clifton Road NE Bldg. 17, Room 3127, MS A-25 Atlanta, GA 30329-4018 404-639-3850	22 - HIV	Frozen	Tim Granade/ Jane Feldman 404-639-3850
Lab 122 CDC/NCEH Air Toxicant Branch Samples Logistic Dept. Attn: David Chambers 3719 N. Peachtree Road Bldg. 109, Sample Logistics Chamblee, GA 30341-2251 770-488-0185	54 - VOC Blood	Refrigerated	Dr. Ben Blount 770-488-4312
Lab 4 CDC/NCEH Tobacco and Volatiles Branch Attn: Dr. Lalith Silva 4770 Buford Highway Bldg. 103 Loading Dock Atlanta, GA 30341-3717 770-488-3559	150 - Aldehyde	Frozen	Dr. Lalith Silva 770-488-3559
Lab 5 CDC/NCID NCHSTD Attn: Christi Phillips 1600 Clifton Road NE Bldg. 23, 3-661 Atlanta, GA 30329-4019 404-639-2164	46 - Chlam/Trichomonas/M. genitalium 154 - Trichomonas/M. genitalium	Frozen Frozen	Christi Phillips 404-639-2164

Exhibit 8-3. Contract laboratory addresses (continued)

Laboratory/destination specimen shipment address	Vessels/assays	Conditions	Contact name Telephone number
<p>Lab 6 CASPIR Attn: Robert White 602 Webb Gin House Road Building C Lawrenceville, GA 30045-5427 770-339-5942</p>	<p>1 - Lead/Cad/HG/Se/Mn 216- Cr/Co 3 - RBC Folate 5 - Mercury 88 - Acrylamide 110 -Fol1 99-Ferritin/Tfr 70 - Vitamin A, D, E, and Carotenoids 79 - Vitamin C 17 - Cotinine 90 - Perfluor1 67 - Phthalates 32-37 - Xtra Sera 29/89 - Persis Pest 92/93 - BFR1/2 48 - Prior Pest/Flame Retardants 49 - Organophos 86 - Spc Arsenic 62 - Urn Merc/Iodine 50 -Metals 66 - PAH 102 - Perchlorate/VOC/Thio 156 - TSNA/NNAL/NAs 152 - Aromatic Amines 220 - As/Cr/Ni 218-Dilsocyante 52/139 - Xtra urine</p>	<p>Frozen</p>	<p>Robert White 770-339-5942</p>
<p>Lab 9 Emory University Theda Gibson 2015 UPPERGATE DR. Lab 510E Atlanta, GA 30322-0001 404-727-5678</p>	<p>24 - HSV</p>	<p>Frozen</p>	<p>Theda Gibson 404-727-6604</p>
<p>Lab 10 Attn: Alethea Tennill Diabetes Diagnostic Laboratory University of MO - Columbia 1 Hospital Dr. Rm. M772 Columbia, MO 65201 (573)882-2708</p>	<p>4- Glycohemoglobin 9 - Glucose 23 - Insulin</p>	<p>Refrigerated Frozen</p>	<p>Alethea Tennill (573) 882-2708</p>

Exhibit 8-3. Contract laboratory addresses (continued)

Laboratory/destination specimen shipment address	Vessels/assays	Conditions	Contact name Telephone number
Lab 16 University of Minnesota Attn: Susan Kupcho 515 Delaware Street SE Room 13-219 - MOOS Tower Minneapolis, MN 55455-0357 612-624-6153	45 - Alb/Creat	Frozen	Susan Kupcho 612-624-6153
Lab 37 CDC/Human Papillomavirus Laboratory Attn: Mariela Scarbrogh 1600 Clifton Road NE MS G41 Bldg./Rm. 1/1355 Atlanta, GA 30329-4018 404-639-1389	78 - HPV Female Swab 140 - HPV Male Swab	Refrigerated Refrigerated	Mariela Scarbrogh 404-639-1389
Lab 51 NHANES Lipid Laboratory University of Minnesota (ARDL) Attn: Jean Buksa 1200 Washington Ave S Suite 175 Minneapolis, MN 55415 612-625-5040	21 - Lipids 18 - Biochem 13 - CRP 11 - Iron/TIBC/% Saturation	Frozen	Jean Buksa 612-625-5040
Lab 52 CDC/DVRD HPV Attn: Gitika Panicker 1600 Clifton Rd NE MS G-41 Bldg. 23, Rm. 4-410 Atlanta, GA 30329-4018 404-639-2269	77 - HPV Serum	Frozen	Gitika Panicker 404-639-2269
Lab 116 CDC/NCIRD Cytomegalovirus Diagnostic Lab 1600 Clifton Rd NE Bldg 18, Room 6-133, Mailstop G18 Atlanta, GA 30333 (404) 639-2178	138 - Cytomegalovirus	Frozen	Sheila Dollard (404) 639-2178

Federal regulations require packaging all blood, urine, and other liquid diagnostic specimens according to certain regulations and packaging procedures. A complete description of these regulations is contained in Appendix A.

8.11.1 Pack Boxed Specimens

Store the blood and urine vessels in 2-, 3-, and 5-inch storage boxes. Separate the vessels with cardboard grids or foam inserts. Secure the top of the cardboard box to the bottom with a rubber band. Place one absorbent sheet under the rubber band. Select the appropriate size STP Biohazard Packaging system: STP 710- 9" x 9" x 2" and 10" x 10" x 2" STP730 for 9" x 9" x 3", 5" x 5" x 3", 7" x 7" x 3" and STP-740 for 5" x 5" x 7" with foam insert. Place the container in the plastic biohazard bag. Remove as much air as possible and seal the bag. Place the wrapped container into the Tyvek biohazard bag. Wrap and seal the Tyvek bag. Place a rubberband around STP730 packages to hold down the edges. Place the wrapped box back into the freezer or refrigerator.

8.11.2 Pack Medium Shipping Containers for Frozen Shipment

- Place a layer 3 inches thick or at least 15 pounds (two blocks of dry ice cut to NHANES specifications) of dry ice slabs in the bottom of a medium-size Styrofoam shipper.
- Place the sealed specimen container boxes on top of the dry ice.
- Pack the specimen storage boxes tightly in the Styrofoam container to prevent movement.
- Place enough dry ice slabs on top so that the Styrofoam container is filled with dry ice to ¼ inch below the rim, or add a minimum of another 15 pounds of dry ice. One more dry ice block cut to NHANES specifications).
- Place the Styrofoam lid on top of the Styrofoam bottom.
- Place a plastic envelope containing the appropriate shipping manifest and return preprinted label on top of the Styrofoam lid.
- Close the box.
- Secure the shipper with 3 pieces of packaging tape across the open flaps.

- Attach the airbill to the top of the box, secure with packaging tape.
- Attach the Class 9
- Verify UP, Frozen, Overpack, and UN3373 labels are attached

8.11.3 Pack Small Shipping Containers for Frozen Shipment

Pack the specimen storage boxes tightly in the Styrofoam container to prevent movement.

- Place a layer 3 inches thick or 1 block of dry ice cut to NHANES specifications in the bottom of a small shipper.
- Place the sealed specimen container boxes on top of the dry ice.
- Place enough chipped dry ice or dry ice blocks on top so that the Styrofoam container is filled with dry ice to ¼ inch below the rim, or add a minimum 1 block of dry ice cut to NHANES specifications..
- Place the Styrofoam lid on top of the Styrofoam bottom.
- Place a plastic envelope containing the appropriate shipping manifest and return preprinted label on top of the Styrofoam lid.
- Close the box.
- Secure the shipper with 3 pieces of packaging tape across the open flaps.
- Attach the airbill to the top of the box, secure with packaging tape.
- Attach the Class 9.
- Verify UP, Frozen, Overpack, and UN3373 labels are attached.

8.11.4 Pack Medium Shipping Container for Refrigerated Shipment

Some shipments require a coolant to keep the specimens cold but not frozen during shipment. For these shipments, use reusable refrigerant packs. Add enough frozen refrigerant packs to the shipper to keep specimens cold for at least 48-72 hours. Keep approximately 24 refrigerant packs in the freezers at all times, replacing as necessary. Pack all refrigerated containers in Styrofoam shippers.

Pack the specimen storage boxes tightly in the Styrofoam container to prevent movement.

- Seal the 9 x 12 zip-closable plastic bag or the pressure vessel containing the boxes.
- Place at least two large frozen refrigerant packs in the bottom of a shipper.
- Add a layer of crumpled newsprint.
- Place the pressure vessel containing the boxes on top of the newsprint.
- Add a second layer of crumpled newsprint on top of the pressure vessel. Place two additional refrigerant packs on top of the container(s).
- Place the Styrofoam lid on top of the Styrofoam bottom.
- Place the appropriate shipping manifest, one return FedEx preprinted airbill and a blank white 8.5" x 11" Avery label into a 9 x 12 plastic bag and seal. Place this plastic bag containing the manifest and label on top of the Styrofoam lid.
- Vessel 54 shipped to Lab 122 is packed with 4 refrigerant packs on the bottom. Add a layer of crumpled newsprint, then a blue chuck with the white padding facing up. Place the pressure vessel on the white side of the blue chuck, then wrap another blue chuck around the pressure vessel top with the white padding facing the pressure vessel. Place another layer of crumpled newsprint on top of the second blue chuck. Place the Styrofoam lid on and proceed as above.
- Small shippers with refrigerant packs are packed the same as medium shippers with 2 refrigerant packs on bottom, a layer of crumpled newsprint, the pressure vessel, another layer of crumpled newsprint and 2 more refrigerant packs.

8.11.5 Label Shippers

For all destinations, include a preprinted FedEx barcoded airbill containing the Shipping address, account number, package specifications and warehouse return address. Tape the airbill to the top of the shipper.

All shippers must contain a FedEx barcode label and appropriate orientation and warning labels.

Label all shippers with the appropriate warning labels as follows:

- A "Keep Frozen" label and a FedEx Class 9 – Miscellaneous Dangerous Goods label on shippers containing dry ice.
- A "Refrigerate" label on shippers containing refrigerant packs.

- A UN 3373: “BIOLOGICAL SUBSTANCE, CATEGORY B” label on all shippers.
- An “overpack” label on all shippers
- Complete the section of the FedEx label that requests the weight of the contents of the shipper, and if applicable, the section that requests the weight of the dry ice contained in the shipper.
- Place the FedEx label with the appropriate contract laboratory address in a plastic FedEx pouch and attach the window to the cardboard lid of the shipper.
- Add one additional strip of tape across the FedEx pouch.

8.12 Container Protocol and Weekly Shipping List

Exhibit 8-4 illustrates the Container protocol; Exhibit 8-5 illustrates the FedEx shipping list by lab number. Use the container protocol as an aid at the start of each stand when opening new containers. Use the FedEx shipping list as an aid when creating airbills in FedEx Ship Manager.

Exhibit 8-4. Container protocol

2017 Final container protocol					
Lab	Vessel	Test	Lab	Vessel	Container
61	1	Lead/Cad/HG/Se/Mn	CASPIR	2-ml sterile cryovial	9x9 two inch box
61	216	Cr/Co	CASPIR	2-ml sterile cryovial	9 x9 two inch box
54	3	RBC Folate	CASPIR	2-ml cryovial	10x10 two inch box
10	4	<i>Glycohem^a</i>	<i>University of Missouri</i>	<i>2-ml cryovial</i>	<i>9x9 two inch box</i>
61	5	Mercury, Ethyl, & Methyl	CASPIR	2-ml sterile cryovial	9x9 two inch box
60	88	Acrylamide	CASPIR	2-ml cryovial	9x9 two inch box
10	9	Glucose	University of Missouri	2-ml cryovial	9x9 two inch box
54	110	Folate	CASPIR	2-ml cryovial	10x10 two inch box
116	138	Cytomegalovirus	CDC/NCIRD CMV Diagnostic Lab	2-ml cryovial	9x9 two inch box

Exhibit 8-4. Container protocol (continued)

2017 Final container protocol					
Lab	Vessel	Test	Lab	Vessel	Container
54	99	Ferritin/Tfr	CASPIR	2-ml cryovial	9x9 two inch box
54	70	Vitamin A, D, E, & Carotenoids	CASPIR	2-ml cryovial	10x10 two inch box
54	79	Vitamin C	CASPIR	2-ml cryovial	9x9 two inch box
2	122	Hep profile	CDC/NCID Hepatitis Ref Lab	2-ml cryovial	9x9 two inch box
2	87	Hepatit B _s Ab	CDC/NCID Hepatitis Ref Lab	2-ml cryovial	9x9 two inch box
59	17	Cotinine	CASPIR	2-ml cryovial	9x9 two inch box
51	21	Lipids	University of Minnesota	2-ml cryovial	9x9 two inch box
51	11	Iron/TIBC/% Saturation	University of Minnesota	2-ml cryovial	9x9 two inch box
51	18	Biochem ^a	University of Minnesota	2-ml cryovial	9x9 two inch box
10	23	Insulin	University of Missouri	2-ml cryovial	9x9 two inch box
51	13	CRP	University of Minnesota	2-ml cryovial	9x9 two inch box
3	22	HIV	CDC/NCID AIDS Division	2-ml cryovial	9x9 two inch box
9	24	HSV	Emory University	2-ml cryovial	9x9 two inch box
52	77	HPV Serum	CDC/DVRD HPV	2-ml cryovial	9x9 two inch box
4	150	Aldehyde	CDC NCEH Air Toxicant	2-ml cryovial	9x9 two inch box
6	32-37	Xtra sera ^{1b}	CASPIR	2-ml cryovial	9x9 two inch box
28	29/89	Dioxin 1/2 ^b	CASPIR	5-ml cryovial	9x9 three inch box
24	90	Perfluor ^b	CDC/NCEH Environmental Health Lab	2-ml cryovial	9x9 two inch box
28	92/93	BFR1 ^b	CASPIR	5-ml cryovial	9x9 three inch box
16	45	Alb/Creat	University of Minnesota	5-ml cryovial	9x9 three inch box
5	46	Chlam/Trichomonas/M. genitalium	CDC/NCID NCHSTD	5-ml cryovial	9x9 three inch box
5	154	Trichomonas/M. genitalium	CDC/NCID NCHSTD	5-ml cryovial	9x9 three inch box
61	86	Spc Arsenic	CASPIR	2-ml cryovial	9x9 two inch box

Exhibit 8-4. Container protocol (continued)

2017 Final container protocol					
Lab	Vessel	Test	Lab	Vessel	Container
26	48	Prior Pest ^b	CDC/NCEH Pesticide Laboratory	10-ml screwcap	5x5 three inch box
26	49	Organophos ^b	CDC/NCEH Pesticide Laboratory	10-ml screwcap	5x5 three inch box
61	62	Urn Merc/Iodine	CASPIR	10-ml screwcap with green dot	5x5 three inch box
61	50	Metals	CASPIR	5-ml cryovial	9x9 three inch box
61	220	As/Ni/Cr ^b	CASPIR	Five-0 5-ml cryovial	5x5 inch foam box
31	66	PAH ^b	CASPIR	5-ml cryovial	9x9 three inch box
24	67	Phthalates ^b	CDC/NCEH Environmental Health Lab	10-ml screwcap	5x5 three inch box
62	102	Perchlorate/VOC/ Thiocyanate ^b	CASPIR	5-ml cryovial	9x9 three inch box
59	156	TSNA/NNAL/NAs ^b	CASPIR	10-ml screwcap	5x5 three inch box
4	152	Aromatic Amines	CASPIR	5-ml cryovial	9x9 three inch box
4	218	Diisocyanates ^b	CASPIR	5-ml cryovial	9x9 three inch box
6	52	Xtra Urine 1 ^b	CASPIR	5-ml cryovial	9x9 three inch box
6	139	Xtra Urine 2 ^b	CASPIR	5-ml cryovial	9x9 three inch box
4	54	VOC Blood ^a	CDC/NCEH Air Toxicant Branch	7-ml Gray tube	5x5 five inch foam box
37	78	HPV Swab - Female ^a	CDC/Human Papillomavirus Lab	Swab	9x12 Ziploc bag* In shipper with Vessel 140
37	140	HPV Swab - Male ^a	CDC/Human Papillomavirus Lab	Swab	7x7 three inch box
Bold - ship at end of stand				<i>Italics = ship refrigerated</i>	

^a Ship refrigerated. (*Italics*)

^b Ship at end of stand. (**Bold**)

Exhibit 8-5. FedEx shipping list by lab number

2017 FedEx Shipping List by Laboratory Number							
LAB	VESSEL	TEST	LAB	CONDITIONS	Dry Ice (Lbs)	Dry Ice (Kg)	Weight
2	122	Hep Profile ^a	CDC/NCID Hepatitis Ref Lab	Frozen	20	9	25
	87	Hepatitis B _s Ab ^a					
3	22	HIV ^a	CDC/NCID AIDS Division	Frozen	20	9	25
4	150	Aldehyde ^a	CDC/NCEH Air Toxicant Branch	Frozen	20	9	25
5	46	Chlam, Trich, M. <i>genitalium</i> ^b	CDC/NCID NCHSTD	Frozen	30	14	35
	154	Trichomonas, M. <i>genitalium</i> ^b					
6	1	Lead/Cad/HG/Se/Mn ^a	CASPIR	Frozen	30	14	35
	216	Cr/Co ^a					
	3	RBC Folate ^a					
	5	Mercury ^a					
	88	Acrylamide ^a					
	110	Folate1 ^a					
	99	Ferritin/TfR ^a					
	70	Vit A, D, E & Carotenoids ^a					
	79	Vit C ^a					
	17	Cotinine ^a					
	32-37	Xtra Sera ^{a,e}					
	29/89	Dioxin 1/2 ^{a,e}					
	92/93	BFR1 ^{a,e}					
	48	Prior Pest & Flame Retardants ^{b,e}					
	49	Organophos ^{b,e}					
	86	Spc Arsenic ^b					
	62	Urn Merc/Iodine ^b					
	50	Metals ^b					
	66	PAH ^{b,e}					
	102	Perchlorate/VOC/ Thiocyanate ^{b,e}					
	156	TSNA/NNAL/NAs ^b					
	152	Aromatic Amines ^b					
	90	Perfluor ^{a,e}					
67	Phthalates ^{b,e}						
218	Diisocyanates ^{b,e}						
52/139	Xtra Urine ^{b,e}						

Exhibit 8-5. FedEx shipping list by lab number (continued)

2017 FedEx Shipping List by Laboratory Number							
LAB	VESSEL	TEST	LAB	CONDITIONS	Dry Ice (Lbs)	Dry Ice (Kg)	Weight
9	24	HSV ^a	Emory University	Frozen	20	9	25
10	4	Glycohem ^{a, d}	University of Missouri	Refrigerated			10
10	23	Insulin ^a	University of Missouri	Frozen	30	14	35
	9	Glucose ^a					
16	45	Alb/Creat ^b	University of Minnesota	Frozen	20	9	25
37	78	HPV, Female ^{c, d}	CDC/Human Papillomavirus Lab	Refrigerated			10
	140	HPV, Male ^{c, d}					
51	18	Biochem ^{a, d}	University of Minnesota	Refrigerated			10
51	11	Iron, TIBC, %Sat ^a	University of Minnesota	Frozen	30	14	35
51	13	CRP ^a					
51	21	Lipids ^a					
52	77	HPV Serum^{a, e}	CDC/DVRS Lab	Frozen	20	9	25
116	138	CMV ^a	CDC/RDSB STAT Lab Unit 80	Frozen	20	9	25
122	54	VOC Blood ^a	CDC/NCEH Air Toxicant	Refrigerated			10

^a Blood.

^b Urine.

^c Other.

^d Ship refrigerated (shaded).

^e Ship at end of stand or when full (bold).

9.1 Introduction

The purpose of collecting vaginal and penile swabs is to obtain suitable biological specimens to test for human papillomavirus (HPV). Human papillomavirus infection is one of the most common sexually transmitted infections in the United States. Cervical infection with certain types of HPV is a major risk factor for cervical cancer in women. The “high-risk” types of HPV (e.g., HPV 16, 18, 31, 33, 35, 39, 45, 51, 52, 56, 58, 59, 68) are associated with cervical cancer, and the “low-risk” types (e.g., HPV 6, 11, 42, 43, 44) with genital warts. No national surveillance system exists to measure the full burden of HPV infection, and no reliable national population estimate of HPV exists. Therefore, NHANES offers a unique opportunity to assess the prevalence of HPV infection in the general population.

Reducing the prevalence of HPV infection is a Developmental Healthy People 2020 objective: “Reduce the proportion of females with human papillomavirus (HPV) infection.” Detection and typing of HPV DNA in vaginal and penile swabs (in conjunction with testing of NHANES sera for HPV 16 antibody) will allow evaluation of trends in prevalence of type-specific HPV infection by age, sexual behavior, and race/ethnicity. Studies have demonstrated that recovery of HPV from self-collected swabs is comparable to that from physician-collected cervical and penile samples.

HPV vaccine is available, and knowledge of the national prevalence of HPV infection will be critical for planning vaccination strategies in the United States. HPV vaccine is recommended for males and females from 11 to 26 years of age. It protects against new HPV infections; however, it does not cure existing HPV infections or disease.

DNA prevalence data are needed to improve baseline assumptions for models evaluating the impact of a prophylactic HPV vaccine on herd immunity and transmission of HPV 6, 11, 16, and 18, and to monitor the impact of HPV vaccine on prevalence of vaccine as well as nonvaccine types to identify trends indicative of type-replacement or vaccine failures. The objectives of this component are to estimate current HPV infection in the U.S. male population 14-59 years old; to describe relevant characteristics of men with HPV infection; and to provide baseline estimates to measure the impact of prophylactic vaccines.

For females, the HPV Hybrid Capture® II DNA results will be reported to survey participants via the same reporting system as for STD/HIV testing. This system is a respondent-initiated toll-free phone call to the National Center for Health Statistics (NCHS). Results are given to persons tested after a password is provided to verify identity. The HPV-16 serology and the HPV DNA typology will not be reported.

For males, the Roche Linear Array HPV Genotyping results will not be reported to the survey participant via the same reporting system as for STD/HIV testing. If the participant explicitly requests the results for the HPV testing when calling for other STD test results by phone, the health educator will explain that HPV tests take several months to process. If the participant is willing to wait, results will be mailed at a later date.

Primary female and male study participants (SPs) aged 14-59 years collect the HPV swab. The physician prints the appropriate label. Each label includes the test name, six-digit SP ID that correlates with the vessel ID, and the corresponding barcode. The physician counsels each eligible SP and introduces the females to the vaginal collection technique and the males to the penile collection technique using a prepared collection kit.

The female collection kit is designed for SPs aged 14-59 years and includes illustrated collection instructions and one Epicentre® Dacron swab with foam tip. The physician removes the appropriate swab from the collection kit and labels the Epicentre® Dacron swab with the foam tip with the label displaying the vessel ID #78. The physician then places the swab back into the collection kit and gives the collection kit to the eligible SP.

The male collection kit is designed for SPs aged 14-59 years and includes illustrated collection instructions. This kit also includes the Diagene specimen transport media (STM) and Dacron swab. The physician opens the package and places a label on the STM vial, which includes the SP ID and vessel ID 140. The physician then places the swab back into the collection kit and gives the collection kit to the eligible SP.

The SP self-collects the appropriate swab in the mobile examination center (MEC) bathroom. Male SPs place the swab into the labeled vial and place the vial in the designated rack in the bathroom. The assistant coordinator delivers the vial to the laboratory. The female SP places the swab back into the plastic container and returns it to the plastic bag. The assistant coordinator delivers the plastic bag to the laboratory.

The laboratory staff verifies the SP ID and the vessel ID (#78) on the label of the Epicentre® Dacron swab with the foam tip, records the collection in the HPV module, and stores the swab at room temperature. For vessel 140, the laboratory staff verifies the SP ID and correct vessel number on the Diogene STM vial, and checks to verify there is sufficient liquid in the vial and that the cap fits securely. The medical technologist then stores it in a 2-inch box with a 7 x 7 grid in the refrigerator. The laboratory staff ships the specimens weekly to the CDC laboratory.

The laboratory staff also processes serum for vessel 77 (HPV Serum) on SPs aged 14-59 years as part of an SP's blood processing profile. The vessels are stored at -20°C and shipped weekly to the CDC/Human Papillomavirus Laboratory.

9.2 Supplies

The supplies needed for HPV processing and storage are shown in Exhibit 9-1.

Exhibit 9-1. Equipment and supplies—HPV processing and storage

Large padded envelope	Zip closable bag (9" x 12" clear)
7 x 7 three-inch box	

9.3 Protocol

Exhibit 9-2 illustrates the SP's protocol for HPV processing. It is extremely important to follow the processing procedures outlined in these protocols and in this manual. Specimen loss or bias results will occur if the exact procedures are not followed.

Exhibit 9-2. HPV processing protocol

ID	Test name	Ages	Sample	Sample type	Vessel type	Appointment type
78	HPV	14-59 females	1 swab	Vaginal swab	Epicentre® Dacron swab	Primary only
140	HPV	14-59 males	1 swab	Penile swab	Diagene transport media	Primary only

9.4 Labeling Vessels

The physician prints the vessel label.

9.5 HPV Protocol

Process male and female HPV swabs and verify that the swabs are labeled correctly and that the label is legible.

Access the HPV Processing module for all SPs.

- Vessel 78 – HPV (female)
 - Verify that the tip of the Dacron swab in the clear plastic tube is foam. Verify that the SP ID on the label matches the SP ID on the processing screen. Record the processing results in the HPV module and store the swab at room temperature.
- Vessel 140 – HPV (male)
 - Verify that there is sufficient liquid in the bottom of the vial. If not, ask for a re-collection.
 - Verify that the top of the swab is not pressed against the lid so that it loosens the lid.
 - Verify that the lid is tightly on the vial.
 - Record the processing results in the HPV module and store the swab in the refrigerator.

9.6 Record Processing Results

The protocol includes a HPV serum (vessel 77) for primary SPs aged 14-59 years. The volume requirement is 0.5-ml of serum; the storage vessel is a 2-ml cryovial, and it is stored in a 2-inch box with a 9 x 9 grid. The vessel is processed after lipids vessel (vessel 21) and before the biochemistry (vessel 18). The serum vessel is displayed on the blood-processing screen in the correct priority and is recorded in the same manner as the other vessels. Perform container content verification on all vessels processed for each session; for detailed instructions on this process, refer to Chapter 2. This vessel is frozen and shipped when the container is full or at the end of the stand to CDC/DVRD HPV.

Select the correct SP and access the Blood Processing module.

The screenshot shows the Lab Sink software interface. The main window displays a table with columns for SP ID, Sample ID, Status, Type, Gender, Age, Name, Process Status, and HPV. The Process Status column has sub-columns for UC, U, P, CB, B, PC, F, and M. The HPV column has sub-columns for F and M. A context menu is open over the first row (SP ID 329869), listing options: Urine Processing, Blood Processing (highlighted), Q/GTT Processing, Packed Cell Processing, Female HPV Processing, Male HPV Processing, Oral Rinse Processing, Urine Collection, Pregnancy Testing, Hematology, and Refresh.

SP ID	Sample ID	Status	Type	Gender	Age	Name	Process Status							HPV			
							UC	U	P	CB	B	PC	F	M			
329869	329869	SC	P	F	12	HOWARD, CHARLES S											
386827	386827	SC	P	F	26	DEEGAN, DOUG O											
416714	416714	SC	P	F	16	BAILEY, ANTHONY J											
499508	499508	SC	P	F	5	DEEGAN, MARK											
525757	525757	SC	P	M	3	LAST NAME, PAT M											
745052	745052	SC	P	F	12	TIM, SP FIRST NAME M											
767995	767995	SC	P	F	39	NAME, LAST M											
836040	836040	SC	P	M	54	TORRES, LUCAS T											
849425	849425	SC	P	F	16	CAMPBELL, VINNIE N											
919919	919919	SC	P	M	57	PAYNE, IMA L											

To select an SP, use the up and down keys to move up and down the list until the correct SP is highlighted, or drag the mouse arrow to the correct SP and right-click. To access the Blood Processing module, drag the mouse arrow to Blood Processing and left-click.

Record processing results for vessel 77 (HPV Serum) in the Blood Processing module.

Primary SPs aged 14-59 years are eligible for the HPV serum test. Pool the serum and aliquot 0.5-ml into a prelabeled 2.0-ml cryovial. Mark the vessel as Filled –Yes or Filled –No using procedures described in Chapter 8. Store the vessels in a 2-inch tall container with a 9 x 9 grid. Pack the

container in a small shipper, add sufficient dry ice, and ship when full or at the end of the stand to CDC/DVRD HPV. Use existing procedures described in Chapter 8 to pack, label, and ship the shipper.

Select the correct SP and access either the Female or Male HPV Processing module.

Female HPV Module

The screenshot shows the Lab Sink software interface. At the top, there is a menu bar with options: File, View, Utilities, Quality Control, Reports, Modules, Shipping, Window, and Help. Below the menu bar is a toolbar with various icons. The main area contains a table with columns: SP ID, Sample ID, Status, Type, Gender, Age, Name, Process Status, and HPV. The Process Status column has sub-columns: UC, U, P, CB, B, PC. The HPV column has sub-columns: F, M. A context menu is open over the row for SP ID 386827, listing options such as Urine Processing, Blood Processing, OGTT Processing, Packed Cell Processing, Female HPV Processing (highlighted), Male HPV Processing, Oral Rinse Processing, Urine Collection, Pregnancy Testing, Hematology, and Refresh.

SP ID	Sample ID	Status	Type	Gender	Age	Name	Process Status						HPV	
							UC	U	P	CB	B	PC	F	M
329869	329869	SC	P	F	12	HOWARD, CHARLES S	<input type="radio"/>	<input type="radio"/>	<input type="radio"/>	<input type="radio"/>	<input type="radio"/>	<input type="radio"/>	-	-
386827	386827	SC	P	F	26	DEEGAN, DOUG O	<input type="radio"/>	<input type="radio"/>	<input type="radio"/>	<input type="radio"/>	<input type="radio"/>	<input type="radio"/>	-	-
416714	416714	SC	P	F	16	BAILEY, ANTHONY J	<input type="radio"/>	<input type="radio"/>	<input type="radio"/>	<input type="radio"/>	<input type="radio"/>	<input type="radio"/>	-	-
499508	499508	SC	P	F	5	DEEGAN, MARK	<input type="radio"/>	<input type="radio"/>	<input type="radio"/>	<input type="radio"/>	<input type="radio"/>	<input type="radio"/>	-	-
525757	525757	SC	P	M	3	LAST NAME, PAT M	<input type="radio"/>	<input type="radio"/>	<input type="radio"/>	<input type="radio"/>	<input type="radio"/>	<input type="radio"/>	-	-
745052	745052	SC	P	F	12	TIM, SP FIRST NAME M	<input type="radio"/>	<input type="radio"/>	<input type="radio"/>	<input type="radio"/>	<input type="radio"/>	<input type="radio"/>	-	-
767995	767995	SC	P	F	39	NAME, LAST M	<input type="radio"/>	<input type="radio"/>	<input type="radio"/>	<input type="radio"/>	<input type="radio"/>	<input type="radio"/>	-	-
836040	836040	SC	P	M	54	TORRES, LUCAS T	<input type="radio"/>	<input type="radio"/>	<input type="radio"/>	<input type="radio"/>	<input type="radio"/>	<input type="radio"/>	-	-
849425	849425	SC	P	F	16	CAMPBELL, VINNIE N	<input type="radio"/>	<input type="radio"/>	<input type="radio"/>	<input type="radio"/>	<input type="radio"/>	<input type="radio"/>	-	-
919919	919919	SC	P	M	57	PAYNE, IMA L	<input type="radio"/>	<input type="radio"/>	<input type="radio"/>	<input type="radio"/>	<input type="radio"/>	<input type="radio"/>	-	-

Male HPV Module

The screenshot shows the Lab Sink software interface. The main window displays a table of Sample IDs (SPs) with columns for SP ID, Sample ID, Status, Type, Gender, Age, Name, Process Status, and HPV. A context menu is open over the row for SP 836040, showing options for various processing modules. The 'Male HPV Processing' option is highlighted in blue.

SP ID	Sample ID	Status	Type	Gender	Age	Name	Process Status						
							UC	U	P	CB	B	PC	F
329869	329869	SC	P	F	12	HOWARD, CHARLES S	○	○	○	○	○	-	-
386827	386827	SC	P	F	26	DEEGAN, DOUG O	-	-	-	-	○	-	-
416714	416714	SC	P	F	16	BAILEY, ANTHONY J	-	-	-	○	○	-	-
499508	499508	SC	P	F	5	DEEGAN, MARK	-	-	-	-	-	-	-
525757	525757	SC	P	M	3	LAST NAME, PAT M	-	-	-	-	-	-	-
745052	745052	SC	P	F	12	TIM, SP FIRST NAME M	-	-	-	-	-	-	-
767995	767995	SC	P	F	39	NAME, LAST M	-	-	-	-	-	○	-
836040	836040	SC	P	M	54	TORRES, LUCAS T	-	-	-	-	-	-	○
849425	849425	SC	P	F	16	CAMPBELL, VINNIE N	○	○	○	○	○	○	-
919919	919919	SC	P	M	57	PAYNE, IMA L	○	○	-	○	○	-	○

Use the scroll bar to view all SPs scheduled into the session. The active SP is contained in a rectangular box. Use the heads-up display to select the correct SP. Select a different SP if the active SP is not the correct SP.

To select an SP, use the up and down keys to move up and down the list until the correct SP is highlighted, or drag the mouse arrow to the correct SP and right-click. To access the HPV Processing module, drag the mouse arrow to HPV Processing and left-click. Alternatively, use the up and down keys to move up and down the list until the correct SP is highlighted, right-click, and drag the mouse arrow to the correct module.

Document processing results.

Female HPV Swab Processing Screen

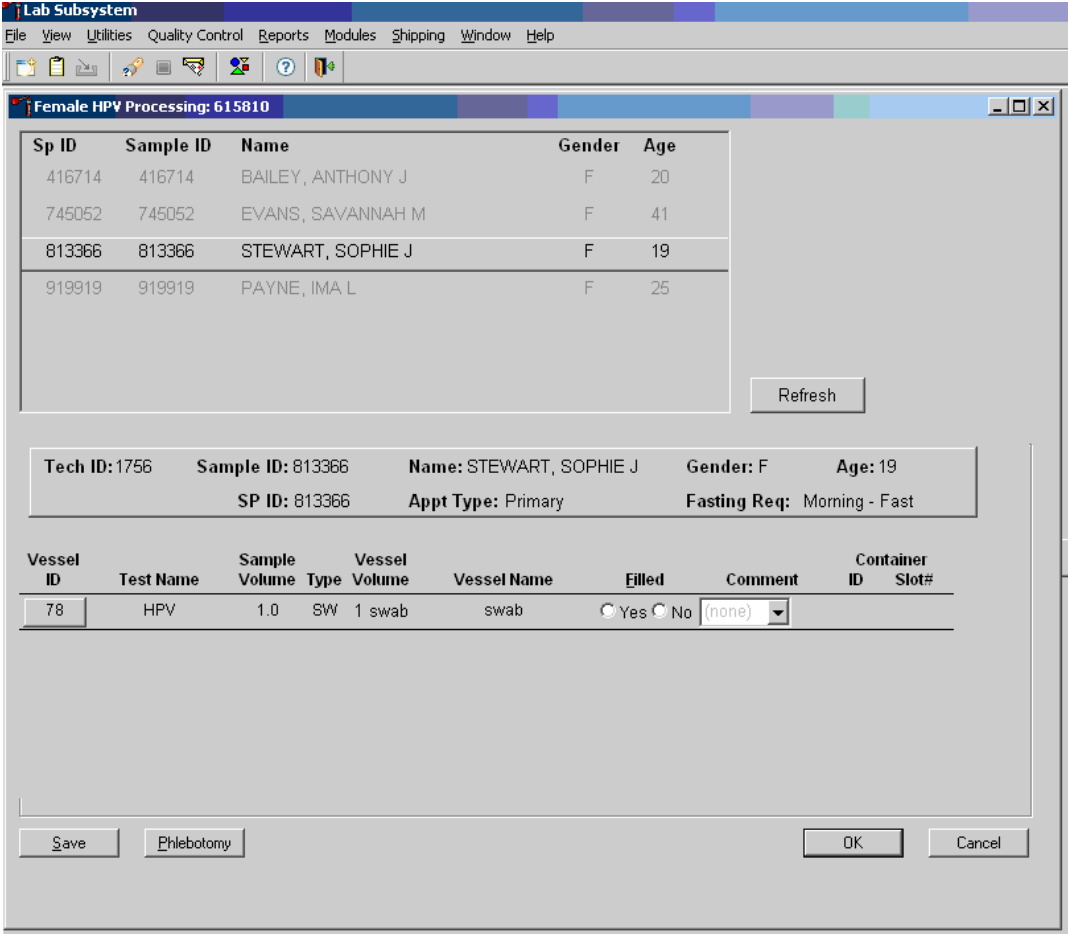

Male HPV Swab Processing Screen

Lab Subsystem

File View Utilities Quality Control Reports Modules Shipping Window Help

Male HPV Processing: 615810

Sp ID	Sample ID	Name	Gender	Age
553872	553872	WRIGHT, LAYLA B	M	21
767995	767995	MURPHY, ISAAC N	M	15
784174	784174	GONZALEZ, SIENNA N	M	50
836040	836040	TORRES, LUCAS S	M	19
861215	861215	SMITH, MICAH S	M	18

Refresh

Tech ID: 1756 Sample ID: 836040 Name: TORRES, LUCAS S Gender: M Age: 19
 SP ID: 836040 Appt Type: Primary Fasting Req: Morning - Fast

Vessel ID	Test Name	Sample Volume	Type	Vessel Volume	Vessel Name	Filled	Comment	Container ID	Slot#
140	HPV	1.0	SW	1 swab	swab	<input type="radio"/> Yes <input type="radio"/> No	(none)		

Save Phlebotomy OK Cancel

Both the Female and Male HPV Processing windows contain the following information for SPs: Tech ID, Sample ID, SP ID, Name (last, first), Gender, Age, Appt (appointment) Type, and Fasting Req. There are columns that list the Vessel ID, Test Name, Sample Volume, Type (SW = swab), Vessel Volume, Vessel Name, Filled (Yes or No) radio buttons, Comment drop-down box, and a Container ID and Container Slot# column. There is one row associated with vessel 78. Use radio buttons to record the processing results, Filled – Yes or Filled – No. If necessary, attach a comment using the Comment drop-down box, and store the vessel in the assigned Container ID and Slot#.

Mark vessel 78 as Filled – Yes if the swab was collected.

Vessel ID	Test Name	Sample Volume	Vessel Type	Vessel Volume	Vessel Name	Filled	Comment	Container ID	Slot#
78	HPV	1.0	SW	1 swab	swab	<input checked="" type="radio"/> Yes <input type="radio"/> No		0415803	1

To mark vessel 78 as collected or Filled – Yes, direct the mouse arrow to the “Yes” radio button and left-click. As a vessel is marked as Filled – Yes, it is automatically assigned to a slot in an existing (open) container.

Mark vessel 78 as Filled – No if the swab was not collected.

Vessel ID	Test Name	Sample Volume	Type	Vessel Volume	Vessel Name	Filled	Comment	Container ID	Slot#
78	HPV	1.0	SW	1 swab	swab	<input type="radio"/> Yes <input checked="" type="radio"/> No	(none)		

To mark vessel 78 as not collected or Filled – No, direct the mouse arrow to the “No” radio button and left-click.

Enter a quality control (QC) comment for vessel 78 when the swab is dry and the judgment is that the SP did not attempt to collect the sample.

NOTE: Send any swab that looks as if it was collected, including bloody swabs and no comment is required.

Sp ID	Sample ID	Name	Gender	Age
140024	140024	PIERCE 4, KIM	F	45
148180	148180	AGUFA 2, DOREEN	F	30
180977	180977	YOUNS 2, ZOYA	F	22
278331	278331	GROFT 2, PAM	F	55
323221	323221	AGUFA 4, DOREEN	F	30
324782	324782	LIU 1, YAN YU	F	41

Tech ID: 2169 Sample ID: 140024 Name: PIERCE 4, KIM Gender: F Age: 45
SP ID: 140024 Appt Type: Primary Fasting Req: Afternoon - No Fast

Vessel ID	Test Name	Sample Volume	Type	Vessel Volume	Vessel Name	Filled	Comment	Container ID	Slot#
78	HPV	1.0	SW	1 swab	swab	<input type="radio"/> Yes <input checked="" type="radio"/> No	(none)		

Save Phlebotomy OK Cancel

Ready HUP: idle MEC Layer: 4/8/2013 Application: 13.5.0 Connected to Coordinator 11:57 AM

To record an “inadequate sample” comment or “no sample received,” direct the mouse arrow to the drop-down list, click to display the comment codes, drag the mouse arrow to “inadequate sample” or “no sample received,” and left-click.

Store the Epicentre® Dacron swab in the assigned 9” x 12” plastic bag at room temperature; review the information in the HPV Processing window, and save the data to the database.

Vessel ID	Test Name	Sample Volume	Type	Vessel Volume	Vessel Name	Filled	Comment	Container ID	Slot#
78	HPV	1.0	SW	1 swab	swab	<input checked="" type="radio"/> Yes <input type="radio"/> No		0415803	1

To record this action or save the data to the database, direct the mouse arrow to the Save button and left-click. To record this action or save the data to the database and exit the module, direct the mouse arrow to the OK button and left-click. To close the window without saving any data in the database, direct the mouse arrow to the Cancel button and left-click.

The process status circle in the heads-up display fills in completely for SPs whose vessel 78 is recorded as collected or Filled – Yes. Do not enter a result until the swab arrives in the laboratory. At the end of each session, review the results for each SP. **Access each record still enabled and enter the Filled – No result for all vessels for SPs for whom no swab was received, and choose the comment “no specimen received.”**

For vessels 78 and 140, perform container content verification on all vessels processed for each session. (For detailed instructions on this process, refer to Chapter 2.)

9.7 Specimen Storage

Record the processing result for the Epicentre® Dacron swab and store the swab in a 9" x 12" plastic bag at room temperature. Store vessels in numbered storage containers according to each vessel as indicated in Exhibit 9-3.

Store each vessel in the appropriate slot in the correct container immediately after processing. Check the slot assignment of containers associated with vessel 78 at the end of each session by accessing the Container Map report. Verify the contents of each container against the container map.

Exhibit 9-3. Storage protocol for HPV

Shipping location	Vessel	Condition	Vessel storage
CDC/DVRD HPV	77 HPV Serum	Frozen	9 x 9 two-inch box
CDC/Human Papillomavirus Laboratory	78 HPV Swab, female	Room temperature	9" x 12" plastic bag
CDC/Human Papillomavirus Laboratory	140 HPV Swab, male	Refrigerated	7 x 7 three-inch box

9.8 Shipping Procedures

Ship vessels 77 and 140 according to procedures described in Section 8.13. Vessel 78 should be placed in a Ziploc bag, then in a biohazard bag, and lastly in the padded envelope, which is placed inside the shipper with vessel 140. Place a barrier (newsprint/blue chuck) between the U-teks and the female swabs. Include a copy of a shipping manifest, which contains a list of the items contained in the shipment and certain demographic information with each shipment. Exhibit 9-4 illustrates the specifications for the shipment of biological specimens to each contract laboratory.

Exhibit 9-4. Shipping protocol

Laboratory	Vessel	Test name	Vessel storage	Shipping frequency
CDC/DVRD HPV	77	HPV Serum	Frozen	End of stand or when full
CDC/Human Papillomavirus Laboratory	78	HPV Swab, female	Refrigerated	Weekly
CDC/Human Papillomavirus Laboratory	140	HPV Swab, male	Refrigerated	Weekly

9.8.1 Pack and Ship Vessel 78

- Place the plastic bag that contains the specimens into a biohazard bag and then into the large padded envelope.
- Place the padded envelope in the shipper with vessel 140. Place a barrier (blue chuck/newsprint) between the U-teks and the female HPV swabs.
- Place the appropriate shipping manifest in a 9" x 12" plastic bag and seal.
- Place a plastic envelope containing the appropriate shipping manifest into the shipper.

9.8.2 Label Shippers

All shippers must contain a FedEx bar-coded label and appropriate orientation and warning labels. Label all shippers with the appropriate warning labels as follows:

- Complete the section of the FedEx label that requests the weight of the contents of the shipper.
- Place the FedEx label with the appropriate contract laboratory address in a plastic FedEx pouch and attach the window to the cardboard lid of the shipper.
- Add one additional strip of tape across the FedEx pouch.

9.9 How to Deal With System Failure

If the computer system fails, record results on a preprinted HPV Processing worksheet (Exhibit 9-5). Complete a Workstation 2 worksheet for each SP while processing the HPV specimens. Enter the results after the system is operational. Send the worksheets to the home office at the end of the stand.

Exhibit 9-5. HPV Processing worksheet

HPV SWAB PROCESSING

SP ID _____

ID	Name	Ages/gender	Sample ml	Sample type	Filled ✓	Slot #
78	HPV Swab, female	14-59 females	1 swab	Epicentre® Dacron Swab		
140	HPV Swab, male	14-59 males	1 swab	Diagene Swab w/Transport Media		

Quality Control and Quality Assurance—Policies and Procedures

10

This policies and procedures quality control and quality assurance chapter is an adjunct to the Westat Policies Manual.

10.1 Safety

10.1.1 Introduction

The National Center for Health Statistics (NCHS) and Westat maintain an ongoing Health and Safety Committee that acts in cooperation with the CDC Office of Health and Safety to ensure safe working conditions for technologists in the NHANES mobile examination center (MEC). Safety precautions for all methods are documented in the Biosafety appendix in the NHANES Laboratory Procedures Manual (LPM). This manual is readily available to all laboratory staff. In addition to annual safety training, the NCHS Biomedical Engineer performs safety inspections at the beginning of each location. The technical supervisor ensures that the primary laboratory analyst reads and is familiar with safety precautions.

10.2 Specimen Submission and Handling

10.2.1 Introduction

The goal of specimen submission and handling is to optimize the accurate and reliable measurement of analytes of interest. Each analytical procedure used in NHANES is documented in the LPM. Each method in the LPM specifies the procedure to be used for preparation of the survey participant, specimen collection, labeling, processing, and preservation, as well as conditions for specimen transport that are appropriate for that method. The methods may refer to the NHANES blood collection protocol or urine collection protocol, noting any special requirements specific to the particular method. These protocols are a starting point due to the special contamination requirements needed for collection of specimens analyzed for metals and volatile organic compounds (VOCs).

10.2.2 Identification of Specimens

Personal identifiers (e.g., names) are not included on test specimens, with the exception of the primary urine containers. The labels that contain the survey participant's (SP's) name and SP ID are destroyed or blacked out with a sharpie before placing the container in the trash receptacle.

NHANES uses a random internal specimen ID number to identify and track individual samples. The Integrated Survey Information System (ISIS) system at Westat and NCHS maintains information that links the specimen ID number to the SP's name.

10.2.3 Questions on Specimen Submission and Handling

The chief medical technologist addresses questions concerning specimen collection, including handling and testing.

10.3 Test Requisition

10.3.1 Introduction

Under a congressional mandate (Section 306 of the Public Health Service Act 42 U.S.C.242k) since 1960, NCHS has collected data on the health of the people of the United States through interviews and extensive physical examinations. Seven surveys using health examination procedures have been completed since 1960. As in previous NHANES programs, the survey's primary purpose is to produce descriptive statistics that can be used to measure and monitor the health and nutritional status of the civilian, non-institutionalized U.S. population. Data collection for this survey involves about 7,000 survey participants per year, of whom about 5,000 per year are expected to be examined. Data collection occurs in 15 different locations (stands) per year.

NHANES performs a complete blood count on survey participants 1 year and older, and urine and/or serum pregnancy tests on female SPs aged 12-59 years, and on girls 8-13 who report that they are menstruating when asked during the home interview. If a urine pregnancy test is positive on any female SP aged 8-17 years, a secondary test is performed using serum. If no blood is drawn, the urine test is repeated. The physician is notified through the ISIS observation function of the second positive or negative secondary test result or of the inability to perform a second test.

A record of the test result report is maintained for a period of 7 years by Westat (the primary NHANES contractor) and by NCHS for an indefinite period.

10.3.2 Laboratory Tests

“Critical” or abnormally high CBC results are reported to the survey participant. The report includes laboratory tests that will be performed. The NCHS medical officer or MEC physician involved in the measurement may also confer with the SP to obtain any other pertinent information that might facilitate the laboratory measurement process.

10.3.3 Human Subjects Review

The NCHS ethics review board (ERB), as defined by the CDC institutional review board (IRB) criteria, shall allow any laboratory analyses conducted on human specimens that are part of a “survey” only after approval of the survey.

10.4 Test Records

10.4.1 Introduction

The purpose of test records is to ensure correct and reliable identification of survey participant specimens and to report accurate test results. The laboratory test record system is distinguished from the test report referred to as the Report of Findings (ROF) that is provided to the survey participant.

10.4.2 Components of Test Records

Test records include:

- Person performing the test (may be identified by initials);
- Printed or electronically stored output from instrumentation that the technical supervisor judges as necessary to document the analytical result;

- Date of specimen analysis;
- Date and time that specimen was collected by the laboratory; and
- Condition of specimens that did not meet criteria for acceptable specimens (e.g., hemolyzed or insufficient quantity for test).

Test records are maintained for a minimum of 7 years. Records may be bound in laboratory notebooks, bound in loose-leaf form, or stored electronically.

10.5 Test Report

10.5.1 Introduction

The laboratory Report of Findings, which gives the results of the tests performed on the mobile exam center (in-house), is provided promptly to the SP as soon as the quality control has been reviewed and approved. The laboratory maintains confidentiality of the survey participant results since it identifies samples only by a specimen ID number. Westat and NCHS maintain the link between the specimen ID number and the identity of the survey participant.

10.5.2 Review, Approval, and Release of Test Results

Upon completion of laboratory testing, the laboratory staff is responsible for reviewing of the quality control results and ensuring that the measurement process was within control limits for each of the participants' analyses.

For NHANES surveys, the initial evaluation of quality control (QC) results is accomplished electronically by comparing the QC results to QC limits stored in a relational database. The laboratory staff performing the complete blood count (CBC) reviews these QC performance results and ensures that only acceptable SP data are reported.

Review and approval of the CBC and pregnancy test results by the MEC physician are documented. Review by the MEC physician includes an evaluation of the consistency of survey participant results with information that may be available on the survey participant (e.g., age, sex). All SPs' CBC samples are run in duplicate, whenever possible. If inconsistent results are noted, and an adequate

sample is available, the test is repeated in duplicate a second time. If the amount of sample is inadequate for repeat, then the survey participant is informed verbally and in writing of the inconsistent result.

Laboratory reports are released only to the authorized SP. Each method includes a description of actions taken, such as when results are markedly elevated or are “panic values.” The SP is contacted immediately by the MEC physician with such results. The data is stored electronically for a minimum of 7 years.

10.5.3 List of Methods and Method Details

NHANES maintains a Laboratory Procedures Manual (LPM), which includes detailed descriptions of each analytical procedure, including analytical sensitivity, specificity, and accuracy, interfering substances, and other information.

10.5.4 Format of the Test Report

The test report includes:

- Name and address of NCHS;
- Test result with a footnote attached representing the name and address where the laboratory test was performed;
- Units of measurement;
- Reference range for each analyte, if available;
- Condition of specimens not meeting the laboratory’s criteria for acceptability; and
- Signature of the NHANES medical officer.

The laboratory report consists of the following;

- 1st page: a cover letter;
- 2nd page: an analysis summary table; and
- 3rd page: to define the key of the name and address where the laboratory test was performed.

A corrected laboratory report has the same format, except the words “corrected laboratory results” replace the words “laboratory results” in the letter and title of the pages. In addition, in the text of the cover letter, the date of the previous laboratory report is noted.

10.5.5 Format for the Laboratory Report Cover Letter

An example of the laboratory report cover letter (Report of Findings) is available upon request.

10.5.6 Format for Listing of Laboratory Results

An example of the laboratory results is available upon request.

10.6 Quality Control

10.6.1 Introduction

Most quantitative analytical procedures involve several operations, or steps, and each operation is subject to some inaccuracy or imprecision or to the possibility of a mistake. The immediate aim of quality control is to ensure that the analytical values produced by a clinical laboratory are sufficiently reliable for their intended purpose. A broader objective is to ensure that all laboratories produce analytical values that meet acceptable standards of precision and accuracy.

Quality control (QC) in laboratory medicine is the monitoring of the analytical measurement process to determine if it is performing correctly and patient results are reportable. An alternate term, “quality assurance,” represents the techniques available to ensure with a specified degree of

confidence that the result reported by the laboratory is correct. Both “precision control” (the agreement between replicate measurements) and “accuracy control” (the agreement between the mean estimate of a quantity and its true value) are evaluated to establish this degree of confidence.

A QA program also monitors laboratory performance to detect excessive random or systematic error. Random error is defined as any deviation from an expected result. There is acceptable or expected random error as defined by standard deviation. There is also unacceptable or unexpected random error that is any data point outside the expected population of data; for example, a data point that is outside of ± 3 SD from the expected result. Factors contributing to random error are those that affect the reproducibility of the measurement. These include instability of the instrumentation; variations in the temperature; variations in reagents and calibrators; handling techniques such as pipetting, mixing, and timing; and operators. Terms used to describe random error include precision, imprecision, reproducibility, and repeatability.

Systematic error describes the error that is consistently low or high, as evidenced by a change in the mean of a control value. The change in the mean may be gradual and demonstrated by a trend in the control values, either above or below the mean. A trend may be caused by the accumulation of debris in tubing or reagent, aging of reagents, gradual deterioration of the control material, or gradual deterioration of the calibration. A change in the mean may be sudden and demonstrated as a shift in control values. Factors that contribute to systematic error are independent of the analyte concentration. Examples of these factors include change in reagent lot, major instrument maintenance, change in room temperature or humidity, failure in the sampling system, or inaccurate calibration.

Exhibit 10-1 presents examples of shifts and trends in QC data.

Exhibit 10-1. Example of shifts and trends in QC data

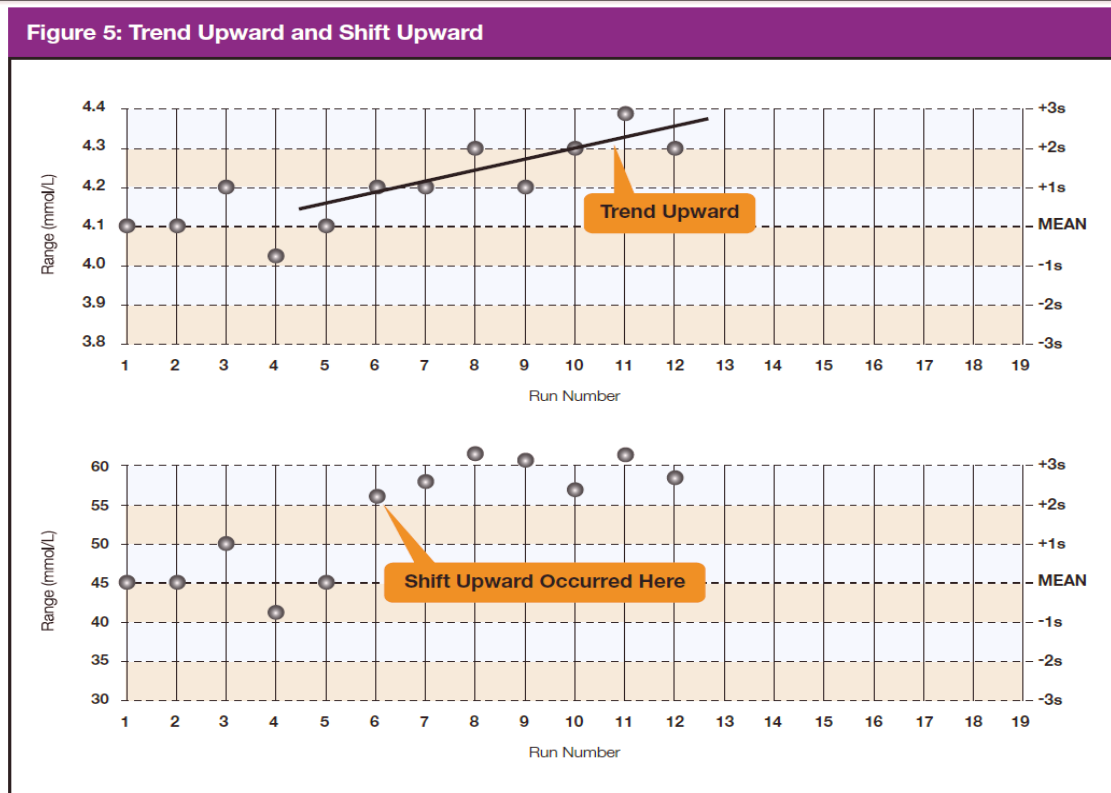

A QC program includes both internal (intralaboratory) and external (interlaboratory) surveillance and monitors the following five parameters:

1. **Clerical Error.** This includes properly documented acknowledgment of transmittal and receipt of specimens (for example, “logging-in”), proper labeling of all specimens, correct assignment of laboratory values to the proper SP ID number, and maintenance of proper records for all specimens for future reference.
2. **Techniques.** This includes continued assurance that all personnel performing an assay understand the principles underlying a particular assay and are cognizant of the proper technique for that assay; that all personnel use the same technique for a particular assay; that there is ready access to a current technique manual; and that periodic review is undertaken to ensure use of the most current and reliable techniques.
3. **Reagents and Materials.** This includes confirmation of commercial standards and controls before they reach the bench; proper labeling of reagents, particularly those prepared in the laboratory; ensuring all reagents in use are not outdated; having an adequate supply of current reliable reagents; and proper calibration of equipment, such as pipettes.

4. **Bench Performance.** This includes the use of controls and standards for each assay performed, a technique based on sound statistical principles that allows the technologist performing the assay to detect error outside of previously determined limits before reporting data; documentation of daily bench performance for detection of less obvious error (particularly those that tend to accumulate over time, so-called “drift”); and established procedures to be followed wherever error is found to exceed previously determined limits.
5. **Instrumentation.** This includes periodic preventive maintenance of all instruments in use in the laboratory and documentation that each instrument is maintaining a previously determined level of each performance at each check.

In this context, QC procedures monitor and evaluate the quality of the analytical testing process of each method to ensure the accuracy and reliability of test results. Thus, QC procedures referenced here refer to the analytical phase of testing and not to the pre-analytic or post-analytic phases.

Quality assurance (QA) addresses all three phases of measurement: pre-analytic, analytic, and post-analytic. QC is therefore viewed here as one part of the overall QA process.

10.6.2 Method-Specific QC Procedures

Specific QC procedures exist for each analytical laboratory procedure in the LPM. The following are some general aspects of QC procedures.

10.6.3 QC Definitions

Internal (“Bench”) Quality Control

For purposes of this document, internal quality control is the evaluation of analytical performance that includes QC bench samples for which the analyst knows the expected measurement result.

Internal commercial quality control materials contain predetermined amounts of analyte in the matrix, qualify under Clinical Laboratory Improvement Amendments (CLIA) as “calibration materials,” and may be used as a “calibration verification” as defined by CLIA.

- **External (“blind”) Quality Control.** For purposes of this document, external quality control is the evaluation of analytical performance that includes QC samples for which the analyst does *not* know the expected measurement result. The analyst is “blind” to the expected measurement result. Examples include proficiency testing samples.

- **Interlaboratory Quality Assurance Program (IQAP).** For purposes of this document, NHANES participates in Beckman Coulter’s® IQAP program. Beckman Coulter issues a report that contains a statistical analysis to evaluate performance. The IQAP compares NHANES 6C Cell controls results to those of other laboratories that use the same instrument.
- **Proficiency Testing.** For purposes of this document, proficiency testing is one method of external quality control in which the analytical performance of a method is evaluated using specimens provided on a periodic basis (usually every 3 months).
- **Analytical Run (Sometimes Simply Referred to as a Run).** An analytical run is a set of samples analyzed in a time within which the measurement system is considered to have stable accuracy and precision. The time for a run may not exceed 24 hours. An analytical run usually consists of both quality control specimens and survey participant specimens.
- **Calibration.** Defined by CLIA as “the process of testing and adjusting an instrument, kit, or test system to provide a known relationship between the measurement response and the value of the substance that is being measured by the test procedure.”
- **Calibration Material.** Defined by CLIA as “a solution which has a known amount of analyte weighed in or has a value determined by repetitive testing using a reference or definitive test method.” Many standards are therefore calibration materials.
- **Calibration Verification.** Defined by CLIA as “the assaying of calibration materials in the same manner as survey participant samples to confirm that the calibration of the instrument, kit, or test system has remained stable throughout the laboratory’s reportable range for survey participant test results.”
- **QC Requirements of Each Analytical Run.** Analysis of survey participant samples is organized into analytical runs. The minimum QC requirement for an analytical run, which is analyzing survey participant specimens, is that the run includes at least two internal (“bench”) QC specimens that meet the NHANES-specified Westgard rules.

10.6.4 Overview of the Relationship Between Internal QC, Proficiency Testing, and External QC

A Beckman Coulter technical representative performs DxH 800 instrument setup and verification and performs and verifies QC checks according to their procedure at the beginning of each stand. Medical technologists perform instrument calibration.

Most laboratory quality control programs include running internal (“bench”) QC with each analytical run to ensure each analytical run is in control. The laboratory participates in proficiency testing programs administered by an outside scientific group to be sure on a periodic basis that accuracy

and precision are within acceptable limits. The IQAP compares NHANES 6C cell control results to other laboratories. These QC systems are used within NHANES. The linearity of the instrument is evaluated at least once a year.

In addition to these systems, NHANES uses calibration materials at the beginning of each stand to standardize the three Beckman Coulter DxH 800 instruments and to provide additional objective evaluation of the quality of specimen analysis. S-CAL® is a calibration material as defined by CLIA (i.e., “a solution, which has a known amount of analyte or has a value determined by repetitive testing using a reference or definitive test method”) that is useful for monitoring method performance.

10.6.5 Internal (“Bench”) QC

Complete Blood Count

The goal of internal QC is to provide a rapid feedback to the analyst on the performance of the measurement process to ensure that the analytical results and factors affecting analytical results are within acceptable limits. At least three internal QC specimens (6C® Cell Control) are included in each analytical run. The QC material used as internal QC specimen has levels of the analyte, which are useful for monitoring method performance.

The 6C Cell Control is a hematology reference control used to monitor the performance of instruments with complete CBC and VCS differential technology. The 6C Cell Control consists of stabilized human blood, so that repeated measurements to monitor daily performance of the instrument system are possible. The 6C Cell Control Tri-Pack contains three levels—when used with Beckman Coulter’s DxH diluent, DxH Lyse Reagent, DxH Diff Pack, they serve as a check on the accuracy of dilution, WBC counts, RBC counts, platelet counts, hemoglobin determinations, and differential counts.

The assigned staff members run all three levels at the beginning of each session to monitor the precision of the instrument following procedures described in Chapter 6.

Standard Levey–Jennings QC charts are maintained for this internal QC specimen. A separate QC chart should be maintained for each QC material used for this internal QC specimen. Standard criteria for run rejection based on statistical probabilities are used to declare a run either in-control

or out-of-control. No results for a given analyte are reported from an analytical run that has been declared out-of-control for that analyte as assessed by internal (“bench”) QC. Rejection criteria are described in each method procedure in the LPM. Quality control results are captured by and stored in the ISIS. Any remedial actions for out-of-control conditions are documented in a QC logbook.

In addition, a latex control (Latron® CP-X control) is used to monitor the volume, conductivity, and light scatter (VCS) of the diff mode only. This control is run at the beginning of each day.

The Latron CP-X control is a ready-to-use suspension of latex particles used to monitor differential parameters on the Beckman Coulter DxH 800. These particles pass through the flow cell and produce characteristic electrical signals. It measures these signals as volume, conductivity, and light scatter.

10.6.6 Coulter Interlaboratory Quality Assurance Program (IQAP)

All DxH 800 instruments participate in Beckman Coulter’s Interlaboratory Quality Assurance Program (IQAP). The Beckman Coulter Data Management System saves results of 6C cell controls in files. Technologists transfer the files to a CD-RW and then send the disk to the Westat laboratory study manager, who uploads the data in the Beckman Coulter IQAP system and compares the results to those from other laboratories. Beckman Coulter issues a report that contains a statistical analysis to evaluate performance. The technologists perform this procedure at the end of each stand, using procedures described in Chapter 6.

The chief technologist will review all Levey–Jennings charts weekly to watch for shifts or trends using the following Westgard rules (Exhibits 10-2 through 10-6).

Exhibit 10-2. Westgard Rule 1_{2s}

Rule 1_{2s}. A single control measurement exceeds 2 standard deviations of control limits either above or below the mean. This rule is used as a warning rule to trigger careful inspection of the control data.

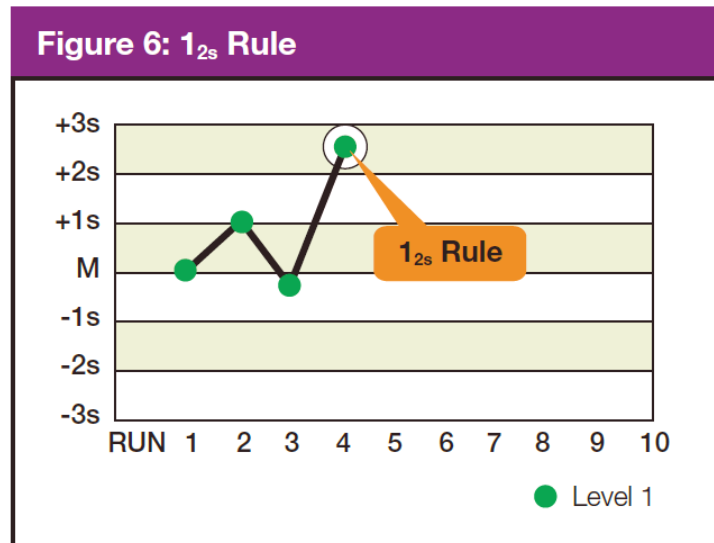
**Exhibit 10-3. Westgard Rule 1_{3s}**

Rule 1_{3s}. Identifies unacceptable random error or possibly the beginning of a large systematic error. Any QC outside ± 3 SD violates this rule. A run is rejected when a single control measurement exceeds the mean ± 3 control limits.

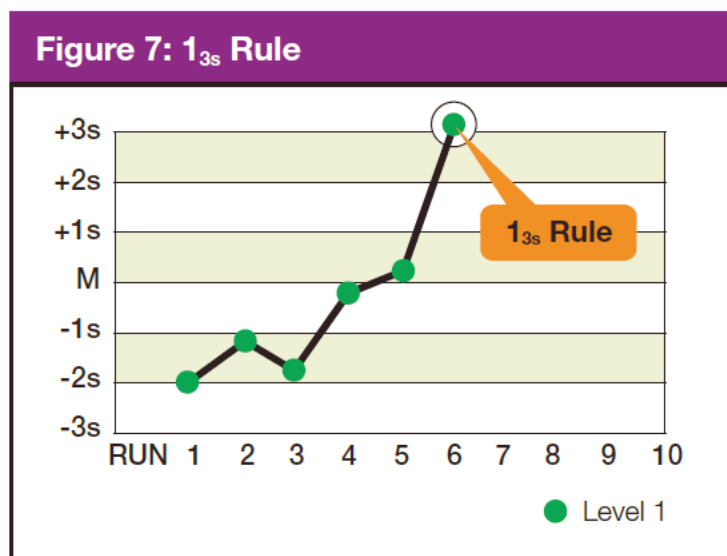

Exhibit 10-4. Westgard Rule 2_{2s}

Rule 2_{2s}. There are two rejection criteria for this rule: two consecutive QC results that are greater than 2 SD that are on the same side of the mean. Violation within the run indicates that systematic error is present and that it potentially affects the entire analytical curve. Violation across the run indicates that only a single portion of the analytical curve is affected by the error. The control run is rejected with two consecutive control measurements are greater than 2 standard deviations of control limits on the same side of mean within or across the run, with this rule.

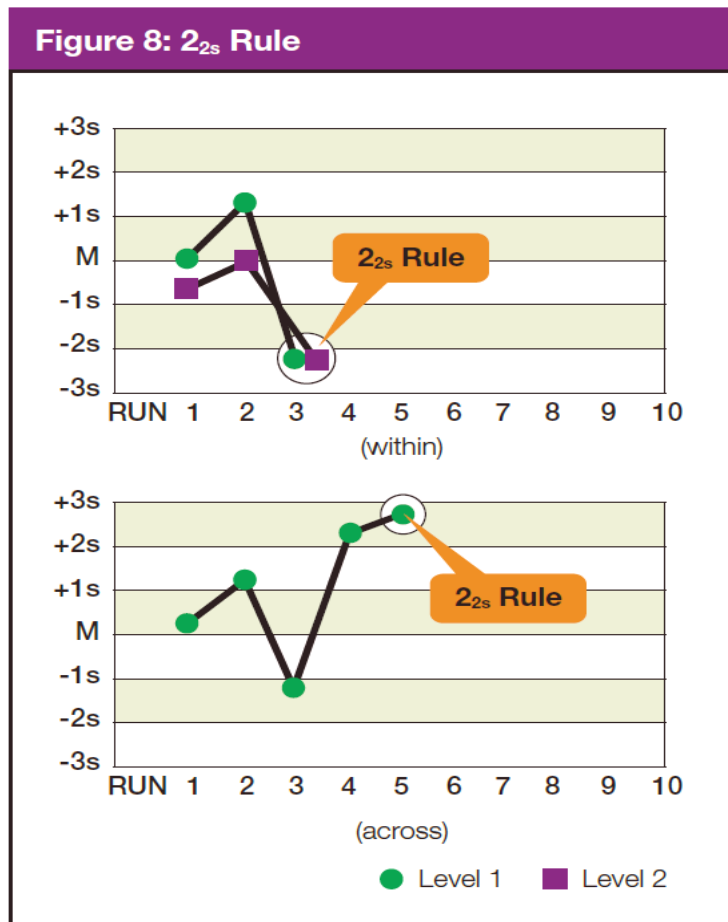
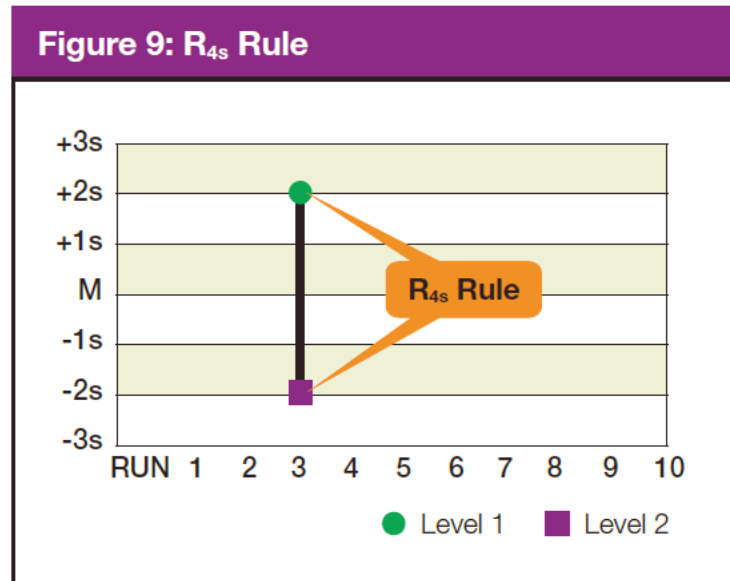

Exhibit 10-5. Westgard Rule R_{4s}

Rule R_{4s} . This rule rejects a run if there is at least a 4 SD difference between control values within a single run. For example, Level 1 control is +2.9 SD above the mean and Level 2 is -1.4 SD below the mean. The total difference between the two control levels is greater than 4 SD. This rule identifies random error and is applied only within the current run.



NOTE: Violation of any of the following rules does not necessarily require rejection of the analytical run. These violations typically identify smaller systematic errors or analytical bias that is not often clinically significant or relevant. Analytical bias may be eliminated by performing calibration or instrument maintenance.

Exhibit 10-6. Westgard Rule 4_{1s}

Rule 4_{1s} . This rule is violated with the 4th consecutive control measurement exceeding 1 standard deviation on the same side of the mean. Troubleshooting action includes calling the Coulter hotline to see if other labs are reporting a bias with the same lot number of control. Perform any suggested diagnostic action or recalibrate if suggested by Coulter.

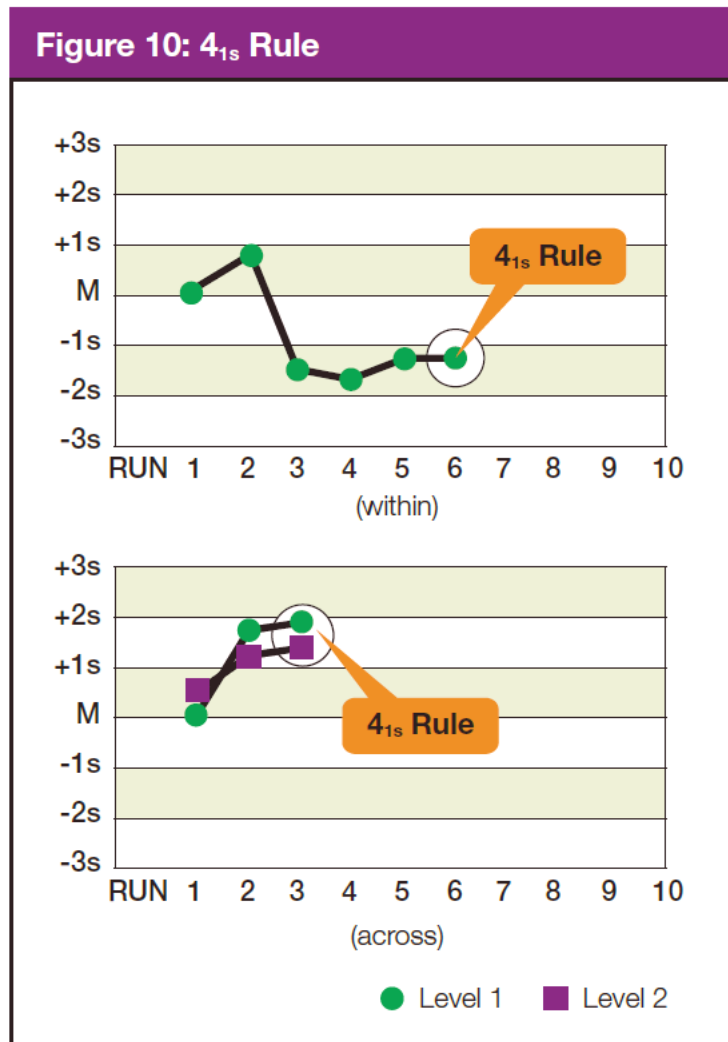

10.6.7 Calibration and Calibration Verification

10.6.7.1 Introduction

Calibration and calibration verification are specified in the documentation of the CBC analytical procedure, in Chapter 6.

10.6.8 Proficiency Testing

Participation in the College of American Pathologists (CAP) proficiency-testing (PT) program is part of the comprehensive quality control program. Each MEC submits results for CAP specimens for evaluation. CAP compares the results to established values and issues a report.

The laboratory will satisfactorily participate in the HCFA-approved PT program for each method used to analyze human samples. Performance in the PT program, along with documentation of remedial action taken for unacceptable performance, is documented in a QC logbook that is available for review.

CAP samples are sent three times a year for hematology. Each shipment includes five 2.5-ml whole blood specimens. Duplicate Beckman Coulter CBC determinations are performed on each whole blood sample using procedures described in Chapter 6. PT samples are handled and analyzed in a manner identical to SP samples. Results are entered and submitted electronically via the CAP website (www.CAP.org); a copy is also sent to the Westat home office.

CAP samples are submitted three times a year for qualitative serum and urine hCG. Each serum shipment includes five lyophilized sera specimens and each urine shipment contains five liquid specimens. PT samples are handled and analyzed in a manner identical to SP samples.

After results have been sent to CAP, but while the CAP samples are still fresh, other technologists will run the samples in the same manner and send their results to the technical supervisor as part of Quality Assurance of each individual tech. A log will be maintained as to the frequency and correctness of these blind runs.

10.6.8.1 CAP Proficiency Testing

For purposes of this document, proficiency testing is one method of external quality control in which the analytical performance of a method is evaluated using specimens provided on a periodic basis (usually every 3 months).

Participation in the CAP EXCEL proficiency-testing program is part of the comprehensive quality control program. Each MEC submits results for CAP specimens for evaluation. CAP compares the results to established values and issues a report.

These samples should be handled and analyzed in a manner identical to SP samples. Results are recorded on the CAP forms and are entered directly on the CAP website. A copy of the CAP form is sent to the home office at the end of the stand.

Results are recorded on the CAP forms and sent to the address specified by CAP Surveys Program Support with a copy to NCHS at the following address:

Renee Storandt – Associate Service Fellow – Laboratory
National Center for Health Statistics
3311 Toledo Road
Hyattsville, MD 20782

Running CAP Proficiency Samples in the Mobile Examination Center

To make barcode labels:

- Utility on desktop
- “Dymo test labels”
- Highlight the label shown
 - Click on “Properties” in far upper right
 - Symbology – choose “Code 128 Auto” this should be the only thing to change but check the following:
 - Data: Barcode – delete “Click ME” or “0000001” and type in proficiency sample number, i.e. FH6-01
 - Align: Center
 - Size: Medium
 - Show Barcode Text: Below
 - OK

- Double click on “Click Me”
- Under Data: Barcode Data, delete “click ME’ and type in proficiency sample number, i.e., FH601
- OK
- Print – will print on Dymo label maker
- Repeat for all five samples
- Exit out
- “No” “Do you want to save?”

To auto-print results for Proficiency samples:

- Verify that “Disable all auto printed reports” box is UNCHECKED in Menu> Setup> System> Printers> Printer set up (it should always be unchecked).
- Menu
- Reporting
- Auto Report
- box “Print Lab Report as Each Analysis is Complete”
- OK
- BE SURE to uncheck box after you have finished running and printing the samples

10.6.8.2 Comparison of Methods Performed on Multiple Instruments or at Multiple Sites

Coulter DxH 800 Comparisons Using American Proficiency Institute Proficiency Testing Samples, Blinded Samples and Beckman Coulter 6C Cell Control Materials

All three DxH 800 instruments will be compared for MEC#1 vs. MEC#2, MEC#2 vs. MEC#3, and MEC#1 vs. MEC#3 two times each year.

NHANES compares DxH 800 analyzers using the following products: American Proficiency Institute proficiency survey samples, blinded samples, and Beckman Coulter 6C Cell Controls.

Optimally, one would compare the CBC with differential between instruments with whole blood specimens, but this is not feasible in NHANES since the MECs are not at the same location. In addition, we can compare only two DxH 800 analyzers at a time since the third MEC is traveling to a new location and its DxH800 is not operational during travel status.

All DXH 800 analyzers can be compared using the American Proficiency Institute's Hematology – 5C surveys that are provided three times each year. Each Hematology – 5C survey challenge contains five whole blood samples. These samples will be run on each MEC in duplicate (similar to participant specimens). We will also use five blinded samples, if the MECs are within driving distance of each other. For the blinded samples, we will draw five EDTA whole blood samples from random participants. These samples will be run in duplicate and compared to the second DxH 800 instrument. Also, we will use the 6C Cell Control provided by Beckman Coulter. The 6C Cell Control contains three levels of material that will be run in duplicate and compared to the second instrument.

We will compare the two or three DxH 800 instruments for each test and results (3-5 results/test) using either a percent difference or absolute difference criteria (see Exhibit 12-7). The percent difference will be calculated as $\text{absolute } (x_1 - x_2) / \text{mean } (x_1, x_2)$. An example calculation of the percent difference is the following: WBC: MEC 1=3.1 and MEC 2 =3.2. The percent difference is $|3.1 - 3.2| / ((3.1 + 3.2) / 2) = 0.1 / 3.15$ or 3.2 percent. The absolute difference will be calculated as $\text{absolute } (x_1 - x_2)$. An example calculation of the absolute difference is the following: Eosinophil %: MEC 1=6.4 and MEC 2=6.7. The absolute difference is $|6.4 - 6.7| = 0.3$. The percent difference and absolute difference criteria were derived from bench quality controls for the DxH 800 from January-May 2013 or from the Beckman-Coulter DxH 800 imprecision data from the Beckman Coulter Hematology Performance Verification Manual. The following criteria (Exhibit 10-7) will be used:

Exhibit 10-7. CAP hematology survey comparison criteria

Test	Percent difference(%)	Absolute difference
WBC	7	NA
RBC	7	NA
Hgb	7	NA
Hct	6	NA
MCH	5	NA
MCHC	5	NA
MPV	7	
MCV	5	
RDW	5	
Platelet	10	
Neut%	7	
Neut#	11	
Lymph%	10	
Lymph#	12	
Mono%	25	
Mono#	35	
Eos%	NA	1.0
Eos #	NA	1.0
Baso%	NA	1.0
Baso#	NA	1.0
nRBC%	NA	1.0
nRBC#	NA	1.0

10.6.9 Calibration Verification

Calibration verification is defined by CLIA as “the assaying of calibration materials in the same manner as survey participant specimens to confirm that the calibration of the instrument, kit, or test system has remained stable throughout the laboratory’s reportable range for survey participant test results.” Thus, calibration verification ensures that the accuracy of the measurement process across the reportable range is maintained over time. For methods approved by the FDA, calibration verification is performed according to the manufacturer’s specification and at the frequency recommended by the manufacturer.

Note that the calibration materials must bracket the reportable range; that is, results should not be reported as a numerical value unless they are within the reportable range. If a result is higher than the upper end of the reportable range and the method permits sample dilution, the sample may be diluted to bring it within the reportable range. If dilution has been necessary, the reported value will exceed the upper end of the reportable range. Each analytical procedure specifies acceptable limits for results of analyses of the calibration materials based on the method precision of these materials.

The reliability of analytical values obtained when using a procedure often depends on the quality of the standards and the calibration procedure. The College of American Pathologists suggests that automated instruments be calibrated using multiple analytical whole blood specimens or a certified, stabilized whole-blood type preparation. The International Committee for Standardization of Hematology (ICSH), by its definition, requires that a calibrator “be based on or traceable to a reference preparation or material.”

Beckman Coulter provides the S-CAL calibrator to meet these requirements. The DxH 800 uses the S-CAL kit that requires a calibrator to convert electronic measurements of each sample into accurate results expressed in clinical terms. The S-CAL calibrates the WBC, RBC, Hgb, MCV, Plt, and MPV parameters. It is a stabilized human-blood preparation. The S-CAL is an acceptable alternative to whole blood calibration. Hct, MCH, MCHC, RDW, and the DIFF parameters do not require calibration.

Calibration is a procedure to standardize the instrument by determining its deviation from calibration references and to apply any necessary correction factors. The calibration procedure uses replicate measurements of S-CAL calibrator. The S-CAL divides the average result into the calibrator Assigned Value to give an Adjustment Factor. Then it obtains and adjusts an instrument reading according to the Adjustment Factor.

The S-CAL is used to calibrate the Beckman Coulter DxH 800 at the beginning of each stand (once every 6-8 weeks), after replacing any component dealing with dilution preparation, if the Beckman Coulter representative suggests it, if controls demonstrate unusual trends or are outside limits, or when the temperature varies by more than 10°F (5.5°C) from the room temperature during the last calibration.

Instructions for the performance of calibration procedures using S-CAL calibration are in Chapter 6.

10.6.10 Linearity

The linearity controls verify the reportable range of Beckman Coulter hematology systems. Linearity is performed at installation, at least yearly, and whenever experiencing an altitude change of 1 mile or more between locations using Beckman Coulter Lin-X™.

Beckman Coulter Lin-X linearity controls are human blood components from which repeated measurements verify the reportable range of Beckman Coulter hematology systems that use both Beckman Coulter® III diluent and Lyse S® III diff lytic reagent. Controls contain one each of Ultra Low Range, Low Range, Mid-Range, High Range, and Ultra High Range. Lin-C™ verifies ranges for the following parameters: WBC, RBC, Hgb, and Plt. Beckman Coulter Lin-C™.

10.6.11 Quality Control Records

Records of all quality control results are maintained for at least 7 years. Quality control results are captured and stored in the ISIS and are available via the IntraWeb. A QC logbook is maintained that documents out-of-control conditions and remedial actions taken to correct out-of-control conditions. The QC logbook also includes copies of results for proficiency testing and calibration.

New lot number crossover studies are performed on Coulter 6C® Cell Controls. The new lot is run against the old lot 20 times before the new lot is put into use.

10.7 Test Methods, Equipment, Reagents, Supplies, and Facilities

10.7.1 Introduction

Analytical procedures use equipment, reagents, materials, and supplies that are appropriate for achieving acceptable accuracy, precision, analytical sensitivity, and analytical specificity from the methods performed in-house. The documentation of individual analytical procedures included in the LPM specifies acceptable equipment, reagents, materials, and supplies. If special requirements concerning water quality, temperature, humidity, electrical power, or other conditions are required for acceptable method performance, then these are described for each procedure in the LPM. Special procedures to monitor these requirements are also included in the documentation of the individual procedure. A lack of requirements in the documentation of the analytical procedure means that the expected day-to-day variation in any of these parameters is acceptable for proper method performance.

Documentation of problems with conditions required (e.g., water quality) for acceptable method performance is maintained in the logbook of the primary instrument used in the analysis. This documentation includes remedial action.

10.7.2 Labeling of Reagents, Solutions, and Other Supplies

Reagents, solutions, and other supplies are labeled to indicate the identity of contents, the concentration (if significant), the recommended storage requirements, the preparation and expiration date, technologist's initials, and any other pertinent information required for proper use. Reagent, solutions, and other supplies are not used when they have exceeded their expiration date.

If a method uses a manufacturer's kit, components of reagent kits of different lot numbers are not interchanged unless otherwise specified by the manufacturer.

Beckman Coulter reagents are monitored and documented in the Beckman Coulter Data Management System and are additionally located on the instrument daily checks report. A copy of all startup results is filed in the quality control notebook and sent back to the home office at the end of each stand. The technologist documents any unusual occurrence in the automated Unusual Occurrence Log or repair of the Beckman Coulter DxH 800 in the automated Equipment Tracking System.

Logs are maintained for reagents other than Beckman Coulter.

10.7.3 Facilities

Laboratories are arranged to ensure that adequate space, ventilation, and utilities are available for all phases of testing: pre-analytic, analytic, and post-analytic.

10.8 Analytical Procedure Manual

10.8.1 Introduction

All procedures performed in the mobile examination center laboratory, on human specimens, are documented in the LPM. A copy of the LPM is maintained at the Westat home office and at NCHS. The individual procedure is also available at or nearby the bench site where the procedure is performed on each MEC.

10.8.2 Contents of the Analytical Procedure Documentation

Each analytical procedure includes the following, when applicable:

- Requirements for specimen collection and processing including criteria for specimen rejection;
- Step-by-step performance of the procedure including test calculations and interpretation of results;
- Preparation of reagents, calibrators, controls, solutions, and other materials used in testing;
- Calibration and calibration verification procedures;
- The reportable range for survey participant test results;
- Quality control procedures;
- Remedial action to be taken when calibration or control results are outside acceptable limits;
- Limitation in methods, including interfering substances;
- Reference range (normal values);
- Life-threatening or “critical values”;
- Pertinent literature references;
- Specimen storage criteria;
- Protocol for reporting critical values;

- Course of action if test system becomes inoperable; and
- Safety considerations for performing the method.

10.8.3 Approval and Record Maintenance

Each procedure is reviewed, approved, signed, and dated by the clinical consultant and technical supervisor and laboratory director of NHANES. Procedures are reapproved, signed, and dated if the director changes. Each change in a procedure is approved, signed, and dated by the current director. The procedure includes the dates of initial use and discontinuance, if discontinued. The procedure documentation is maintained for 7 years after discontinuance of the method.

10.8.4 Method Performance Specifications

Method performance specifications for each analytical method are established or verified:

- **Accuracy** of each analytical method will be determined by analysis of calibrators and yearly linearity checks as described in the section of the LPM on quality control.
- **Precision** of each analytical method is determined by analysis of QC reference materials as described in the section of this manual on quality control.
- **Analytical specificity** is determined for each method including effects of potential interfering substances by the manufacturer. This may be verified by testing the effect of potential interfering substances in method development, by analyzing reference materials, by comparing results on split samples with a method considered more definitive, and/or by analyzing a sample of persons ($n > 20$) and examining the measurement output searching for interference. The appropriate procedures for verifying analytical specificity will vary by analytical method. Substances that interfere with the analysis in the reportable range are listed in the method procedure.
- **The reportable range of test results** is described in the documentation of the analytical procedure.
- **Reference range (normal range)**— if available, the reference range of test results is described in the documentation of the analytical procedure and on the test report.
- **Other pertinent performance specifications** that are required for adequate method performance are specified in the documentation of the analytical procedure.

10.9 Equipment Maintenance and Function Checks

10.9.1 Introduction

Laboratory equipment is checked regularly to ensure acceptable performance. Maintenance (including preventive maintenance) and external checks are documented in the Laboratory and Phlebotomy Quality Control modules in the Integrated Survey Information System (ISIS). The frequency of maintenance and daily checks follows the manufacturer's recommendations, when available. The manufacturer's recommendations are included in the manuals that are located in notebooks in the laboratory.

Each analytical procedure outlines the equipment maintenance and function checks for proper method performance and acceptable results from the checks. These checks must be made at the interval specified in the documentation of the procedure. Failure of a function check is documented in the automated Unusual Occurrence Log.

10.9.2 Laboratory Equipment Calibration

- Eppendorf Pipettes
 - The Eppendorf Xplorer Plus electronic pipettes are calibrated once per year. Pipettes are sent to the manufacturer and calibration certificates are kept on file at the home office.
- Troemner Scale Weights
 - The Troemner Scale Weights are calibrated once per year. Scale weights are sent to the manufacturer and calibration certificates are kept on file at the home office.

10.9.3 Temperature Monitoring

Temperature recordings are required for storage and preservation of reagents and sample material (analytical specimens), as well as quality control and reference materials. A TempGuard system is utilized to constantly monitor the refrigerator and freezer temperature in the laboratory. This system is monitored 24 hours, 7 days per week. If an alarm is not addressed within 10 minutes, a call center will begin calling the FES and MEC Manager to alert them to the alarm. During normal work hours

the medical technologists will respond to the alarms. Room temperature is monitored and recorded during days of operation.

The refrigerators, freezers, and TempGuard systems are calibrated twice per year. The medical technologists record the temperature of each unit, comparing the TempGuard to a NIST-certified thermometer, and the field equipment specialist (FES) uses a certified digital thermometer.

Beckman Coulter, Vacutainer, and Sure-Vue have recommended the following storage conditions for reagents and tubes (Exhibit 10-8). Quality control temperature ranges have been established based on these recommendations.

Exhibit 10-8. Recommended storage conditions for reagents and tubes

Reagent	Manufacturer's recommended storage conditions	Established range
CoulterDxH Lyse DxH Diluent	2-40°C (36-104°F)	15-30°C (59-86°F)
DxH Cleaner DxH Diff Pack	2-25°C (36-77°F)	15-25°C (59-77°F)
S-CAL at room temperature	16-32°C (60-90°F)	15-30°C (59 to 86°F)
S-CAL at refrigerated temperature	2-8°C (35-46°F)	2-8°C (36 to 46°F)
Latron	2-30°C (36-86°F)	15-30°C (59 to 86°F)
6C Cell Control	2-8°C (36-46°F)	2-8°C (36 to 46°F)
Sure-Vue Urine and Serum hCG Controls	2-8°C (36-46°F)	2-8°C (36-46°F)
Vacutainers	Not greater than 77°F	15-30°C (59 to 86°F)

The following ranges have been established for monitoring instrument quality control (Exhibit 10-9).

Exhibit 10-9. Established ranges for monitoring instrument quality control

Instrument	Manufacturer's instrument range or limit	Established range
Beckman centrifuge (refrigerated)	<-5 to +30°C (23-86°F)	2-8°C (35 to 46°F)
Beckman centrifuge (room temperature)	-5 to +30°C (23-86°F)	17-30°C (62 to 86°F)
Revco freezer	-30°C (-22°F) Limit	-26 to -34°C (-15 to -29°F)
Jewett freezer	-20°C (-4°F) Limit	-18 to -23°C (0 to -10°F)
Jewett refrigerator	2-5°C (35 to 41°F)	2-8°C (35 to 46°F)
LFBS	0.450	0.350 to 0.550
Phlebotomy refrigerator	None	2-8°C (35 to 46°F)
Mettler Toledo Scale	One 100g weight (start of stand QC)	+/- 1.0 grams
Mettler Toledo Scale	Two 300g weights (start of stand QC)	+/- 6.0 grams
Mettler Toledo Scale	One 500g weight (daily QC)	+/- 5.0 grams
Mettler Toledo Scale	One 20g weight (daily QC)	+/- 0.2 grams

Two thermometers monitor ambient temperature in the laboratory and one thermometer monitors ambient temperature in the phlebotomy room. The allowable temperature range for these rooms is 15 - 30°C (59 - 86°F).

The acceptable temperature range for refrigerators used for storage of CLIA-regulated specimens and reagents is 2-8°C and is checked and recorded daily. This is monitored daily by the TempGuard system and is recorded in the Laboratory Information System.

Freezer temperatures are monitored daily by an automated TempGuard system. The range of allowable temperature for the -20°C Jewett model is -18 to -23°C. The range of allowable temperature for the -30°C Revco model is -26 to -34°C.

An automated continuous TempGuard system monitors the room temperature and the internal temperature of the laboratory refrigerators and freezers. When the system detects a significant increase in the temperature, it begins calling designated staff. The MEC managers and Facilities and Equipment Specialists (FES) have been identified as those individuals responsible for responding to the call by typing in a response code. The temperature increase could be confined to one freezer or refrigerator, to multiple units, or all units. The temperature increase could be due to any number of circumstances such as a loss of power because a circuit breaker tripped, a compressor malfunctioned, or a system failed. The MEC manager or data manager implements corrective actions that are warranted to prevent loss of biological specimens.

Freezers and refrigerators are regularly monitored for excessive ice deposit, inoperative cooling fans, and frayed or worn electrical power connections. Problems are reported to the FES, MEC manager, and the Laboratory Study Manager.

10.9.4 Humidity Monitoring

Humidity monitoring is required because unusually high, low, or extreme fluctuations in humidity can cause deterioration of reagents and test components, and can affect the rate of chemical reactions and specimen interaction. This reading will be recorded daily in the daily lab QC in the LIS. A range of <80% is acceptable to operate the laboratory.

10.10 Troubleshooting

10.10.1 Introduction

Troubleshooting actions are taken and documented when:

- Test systems perform outside acceptable performance specifications. Troubleshooting is documented in the appropriate QC manual.
- Results of control materials and calibration materials fail to meet quality control criteria. Troubleshooting is noted in the appropriate QC logbook.
- The laboratory cannot report survey participant test results within its established period. If the reporting of data will exceed the agreed upon timeframe, the MEC and final Report of Findings indicate the test results are not available.
- Errors in the reported SP test results are detected. When errors are detected in the reporting of survey participant results, the MEC physician notifies the survey participant by phone, followed by the issuance of a corrected report within a time period suitable to the survey participant, but not to exceed 1 week. The corrected report clearly shows the corrected results in the title. Exact duplicates of the original as well as the corrected report are maintained for 7 years.

10.11 Integrated Survey Information System (ISIS)

10.11.1 Introduction

One of the purposes of the ISIS is to store survey participant results for retrieval in a period acceptable for the intended use of the data. Survey participant test results are stored in a database. The ISIS consists of the PC databases used for storing survey participant results. This form for the ISIS facilitates the interfacing of varied and complex instrumentation used in many of the analytical procedures. The MEC LAN hardware serves as the hardware for the ISIS. The identification of the survey participant result is by specimen ID number, and the result is accessible by this number.

The minimum amount of data stored for each analytical result is the specimen ID number, the analyte name, and the measured result. If the specimen ID does not provide sufficient information to relate the measured result to the QC data for the run, then the run number and run date must also be stored. The specimen ID, run date, and run number should be sufficient information to relate the measured result to the quality control information for that run. Access to the ISIS database is password protected so that only the persons authorized by Westat and NCHS may access the data.

10.11.2 Integrated Survey Information System Data Down Times

Each laboratory method is able to run and temporarily store results even if the MEC LAN is inoperable.

10.11.3 Maintenance of LAN Hardware

After failure of a LAN component, ISIS should be able to be repaired or replaced within a day by a functioning component. LAN hardware is readily available. PC components and the infrequent problems with this hardware are readily correctable in this period. Westat participates in the standard service contract arranged for NHANES for service of failing or failed computer equipment.

10.11.4 Backup Schedule of Integrated Survey Information System Data

ISIS data stored on LAN hard disk drives are backed up to tape once each weekday (Monday through Friday). If ISIS data are stored on local PC or minicomputer hard drives, they are archived to a second hard disk, tape, optical diskette, or CD-ROM at least once a week.

10.12 Communications and Complaints

10.12.1 Introduction

Good communication between the laboratory and persons reviewing laboratory analyses is essential for proper use of laboratory results. NHANES encourages collaborative relationships between technologists and physicians utilizing laboratory data. This collaborative interaction is the primary mechanism by which NHANES evaluates the effectiveness of laboratory protocols and other laboratory communications. If the laboratory has a persistent problem with meeting laboratory criteria (e.g., inadequate amount of specimen), the MEC manager, technical supervisor, or laboratory director will discuss the problem with the person in a collaborative spirit. The technical supervisor is the laboratory component specialist from Westat, whereas the laboratory director is the laboratory specialist from NCHS.

Similarly, complaints of laboratory performance are carefully considered. Usually, these complaints are fixed with minor adjustment or explanation. Each member of the laboratory staff is responsive to complaints that have merit and relate to her or his responsibilities. Nontrivial complaints are reported to supervisors, who will decide appropriate actions, including investigation and remedial action. The technical supervisor maintains documentation of nontrivial complaints concerning laboratory performance that are reported to her or him.

10.13 Quality Promotion

10.13.1 Introduction

High-quality laboratory results are generated when all phases of the measurement process (i.e., pre-analytic, analytic, and post-analytic) are conducted properly. Factors that promote high quality results include:

- Competent, well-trained, and motivated laboratory staff;
- Quality laboratory facilities;
- Well-maintained, high-quality laboratory equipment;
- High-quality laboratory analytical methods; and
- Clear commitment of management to quality laboratory results.

NHANES is committed to supporting each of these factors to enhance quality.

10.14 Quality Assurance Program

10.14.1 Introduction

The goal of the NHANES Quality Assurance Program (QAP) is to monitor and evaluate the overall quality of the testing process including pre-analytic, analytic, and post-analytic phases.

The initial database and reporting system design included the following requirements:

- All data are released in a timely manner relative to its intended use. All CBC results are provided to the SP in a preliminary Report of Findings when the SP checks out of the MEC. If the results are not available by the time the SP checks out of the MEC, they are reviewed by the MEC physician as soon as they are available, and the SP is notified by telephone of any abnormal results. A hard copy of the CBC results is included in the final Report of Findings sent to the SP 6-12 weeks after the MEC examination. In the case where no blood was drawn, the preliminary or final Report of Findings states, “Not done.” In the case where blood was drawn (but it was not possible to run, CBCs within 24 hours of collection and no results were transmitted), the preliminary or final Report of Findings states, “Data not available at this time.”

- The preliminary and final Report of Findings are ISIS-generated and are based on results in the database; they are not predefined reports stored in the system. The format for the English and Spanish preliminary and final Report of Findings is tested annually to determine if the generic format is legible.
- The preliminary and final Report of Findings format includes reference ranges, units of measure, or notation for inadequate specimen. Sample preliminary and final English and Spanish Report of Findings are printed and the format is tested annually.
- NCHS is responsible for sending the final Report of Findings to each survey participant. Mailing labels are printed, the mailing label is matched to the final Report of Findings, and the final Report of Findings is inserted into the envelope. NCHS monitors communications from SPs who report that they have received the incorrect Report of Findings.
- All results are generated based on results stored in the database. The ISIS system prohibits the MEC technologist from changing data in the database after the SP has checked out of the MEC or if the MEC Report of Findings has been printed. All subsequent copies of results should match the original results. If any result is ever changed in the database, a back-end editing request system form is submitted, tracked, and maintained by ISIS.
- A comprehensive security system guards against unauthorized access. A complete description of this system is maintained by and is available through NCHS.

The basic mechanism for the QAP is the quality audit. The quality audit is conducted by the NHANES technical supervisor or laboratory director, who maintains documentation of the results of the quality audits, including remedial actions taken to address conditions that merited corrective action.

10.14.2 Quality Audit: Survey Participant Test Management

The quality audit for survey participant test management is conducted at least yearly and consists of:

- A survey of the laboratory staff, and of the analytical procedures used in NHANES. The survey includes requests for information on:
 - Any changes that need to be made in survey participant preparation, specimen collection, labeling, preservation, and transportation;
 - Any changes that need to be made in completeness and relevance of survey participant information obtained at the time the specimen is acquired, and the use and appropriateness of specimen rejection criteria based on their experience and interactions with persons requesting the tests;

- Laboratory-reporting errors encountered since the last survey;
- Whether the performance of the Integrated Survey Information System (ISIS) is adequate for their measurement systems; and
- Nontrivial complaints from outside the laboratory about performance of the lab.

The technical supervisor and laboratory director assess the results of the audit and implement corrective actions that are warranted.

10.14.3 Quality Audit: Quality Control

Quality control addresses the analytic phase of measurement. The purpose of the internal (“bench”) quality audit is to ensure that the QC analyses were performed and appropriate actions were taken when out-of-control conditions occurred. The quality audit of quality control shall be conducted at least yearly by the technical supervisor and laboratory director and shall consist of:

- A review of a random 10 percent sample of 6C Cell and Latron control results. The review evaluates whether appropriate corrective action was performed and documented for out-of-control conditions.
- An analysis of the proficiency testing results. The analysis and review will assess PT performance and, if unsatisfactory, whether the deficiencies have been adequately addressed. The technical supervisor and laboratory director compare results to determine the correlation coefficient. This correlation must be greater than 0.95, or the laboratory director may give written approval that the methods are sufficiently similar for the intended use of the data.
- The review of documents that demonstrate that at least once every 6 to 8 weeks the S-Cal calibrator was run on three instruments.

The technical supervisor and laboratory director assess the results of the audit and, in consultation with Beckman Coulter, implement corrective actions that are warranted.

10.14.4 Quality Audit: Personnel

Well-trained and competent personnel are essential components of good laboratory performance. The quality audit of personnel is conducted at least yearly by the technical supervisor and laboratory director and shall consist of:

- A review of the 6C Cell and Latron control (“bench”) results or IQAP QC results for 10 percent of the total control runs covering a period of not less than 1 year. The internal (“bench”) QC reflects the performance of persons performing the method. If out-of-control conditions occur with a frequency more than twice the expected statistical probability (e.g., 95% control limits would normally be exceeded by 5% of the analytical runs), the technical supervisor and laboratory director will assess whether the unacceptable performance is due to the performance of the person in question or other factors (e.g., failing equipment). If the personnel performance is the cause, the technical supervisor and laboratory director determine and implement appropriate remedial action (e.g., training).
- A review of all remedial action since the last audit to assess the effectiveness of the action. Acceptable performance of the method by the person involved for 1 month after remedial action is acceptable evidence of the effectiveness of remedial action.
- The technical supervisor and laboratory director audit the documentation of personnel training and evaluation to check whether the analyst has been appropriately evaluated in the last year (or 6 months if in the first year performing a new method). The evaluation criteria are described in the Personnel Training and Evaluation section of the LPM (Chapter 10, Section 10.16). The technical supervisor maintains documentation of the results of the audit.

10.14.5 Quality Assurance Review with Staff

The technical supervisor and laboratory director prepare a report of the results of quality audits within 3 weeks of the completion of the audit. The technical supervisor and laboratory director review pertinent information with appropriate staff to ensure that effective remedial actions are taken. The technical supervisor and laboratory director also notify staff members who have been involved in the audit if their performance was acceptable and that no remedial action is needed. At least once every 6 months, the technical supervisor and laboratory director review the results of quality audits.

10.15 Personnel Training and Evaluation

The technical supervisor ensures that persons performing laboratory tests receive appropriate training. The performance of persons performing laboratory tests is evaluated every 6 months for the first year testing is performed and annually thereafter. The evaluation shall consist of:

- Direct observation of test performance, including survey participant preparation (if applicable), specimen handling, specimen processing, and testing;
- Direct observation of the recording and reporting of test results;
- Review of QC results, IQAP, PT, and linearity results and preventive maintenance records;
- Direct observation of performance of instrument maintenance and function checks;
- Assessment of testing performance using blind QC materials; and
- Assessment of problem-solving skills.

The technical supervisor maintains documentation of the evaluations for at least 7 years. If remedial action is warranted, the technical supervisor shall discuss the results of a personnel evaluation with the person evaluated and implement appropriate action (e.g., training).

10.16 Competency Assessment

10.16.1 Introduction

Competency is the ability of personnel to apply their skill, knowledge, and experience to perform their laboratory duties correctly. Competency assessment is used to ensure that the laboratory personnel are fulfilling their duties as required by Federal regulation.

The following six (6) procedures are the minimal regulatory requirements for assessment of competency for all personnel performing laboratory testing:

1. Direct observations of routine patient test performance, including patient preparation, if applicable, specimen handling, processing, and testing;
2. Monitoring the recording and reporting of test results;

3. Review of intermediate test results or worksheets, quality control records, proficiency testing results, and preventive maintenance records;
4. Direct observations of performance of instrument maintenance and function checks;
5. Assessment of test performance through testing previously analyzed specimens, internal blind testing samples or external proficiency testing samples; and
6. Assessment of problem-solving skills.

Competency assessment, which includes the six procedures, must be performed for testing personnel for each test that the individual is approved by the laboratory director to perform.

Documented competency assessment is required for individuals fulfilling the following personnel responsibilities outlined in Subpart M of the CLIA regulations: clinical consultant (CC), technical consultant (TC), technical supervisor (TS), general supervisor (GS), and testing personnel (TP). Clinical consultants, technical consultants, technical supervisors, and general supervisors who perform testing on patient specimens are required to have the six required procedures in their competency assessment in addition to a competency assessment based on their Federal regulatory responsibilities.

The Technical Consultant for moderate complexity testing (42 CFR §493.1413(b)(8)) is responsible for performing and documenting competency assessments. The competency assessments may also be performed by other personnel who meet the regulatory qualification requirements for TC for moderate complexity testing.

Evaluating and documenting competency of personnel responsible for testing is required at least semiannually during the first year the individual tests patient specimens. Thereafter, competency assessment must be performed at least annually. Competency assessment can be done throughout the entire year by coordinating it with routine practices and procedures to minimize impact on workload.

NOTE: If test methodology or instrumentation changes, an individual's competency must be reevaluated to include the use of the new test methodology or instrumentation prior to reporting patient test results.

10.16.2 NHANES Competency Assessment Plan

The competency of the staff will be evaluated and documented by the technical supervisor, using the competency assessment (testing personnel) form shown below (Exhibit 10-10). All aspects of the NHANES Laboratory that fall under CLIA regulations will be assessed and documented. Competency assessments will occur every 6 months for new hires and annually after that.

Exhibit 10-10. NHANES competency assessment plan

CDC - NHANES Westat 1600 Research Blvd. Rockville, MD 20850					
Competency Assessment (Testing Personnel)					
Name:		Job Title(s):		Lab Section:	
Elements of Competency Applicable to Test System	1. Direct Observation of Testing 2. Review/Reporting Results/Critical Values		3. Review QC, PT, PM 4. Direct Observation PM		5. Blind Testing (PT, QC, RS) 6. Evaluate problem-solving skills
Test System	Component/Process/Analyte	Elements to Assess	Acceptance Criteria	Acceptable/Comments	Date Completed
Chemistry Specimen Processing <input type="checkbox"/> Waived <input type="checkbox"/> Non-Waived	Routine Specimen Collection/Transport/Processing	1,6	Pass Specimen Processing Quiz (Score >90%)		
	Criteria for Accepting/Rejecting Specimens	1,2	Evidence of daily work must demonstrate 100% proficiency with recognizing unacceptable specimens and the appropriate disposition.		
Beckman Coulter ICON 25 <input type="checkbox"/> Waived <input type="checkbox"/> Non-Waived	Beckman Coulter ICON 25 hCG Combo Test	1	Complete direct observation checklist for ICON 25 hCG combo test kit and score 100%. <ul style="list-style-type: none"> ■ ICON hCG Combo Test ■ Qualitative Serum hCG ■ Qualitative Urine hCG 		
		3	Review urine and serum hCG QC log		
		4	Review test reporting		
		5	Successfully participate in CAP PT for both serum and urine hCG		

Exhibit 10-10 NHANES competency assessment plan (continued)

CDC - NHANES Westat 1600 Research Blvd. Rockville, MD 20850					
Competency Assessment (Testing Personnel) (continued)					
Name:		Job Title(s):		Lab Section:	
Elements of Competency Applicable to Test System	1. Direct Observation of Testing 2. Review/Reporting Results/Critical Values		3. Review QC, PT, PM 4. Direct Observation PM		5. Blind Testing (PT, QC, RS) 6. Evaluate problem-solving skills
Test System	Component/Process/Analyte	Elements to Assess	Acceptance Criteria	Acceptable/Comments	Date Completed
<input type="checkbox"/> Waived <input type="checkbox"/> Non-Waived	Routine Specimen Collection/Transport/Processing	1,6	Pass Specimen Processing Quiz (Score >90%)		
	Criteria for Accepting/Rejecting Specimens	1,2	Evidence of daily work must demonstrate 100% proficiency with recognizing unacceptable specimens and the appropriate disposition.		
<input type="checkbox"/> Waived <input type="checkbox"/> Non-Waived	Beckman Coulter DxH 800 ■ WBC ■ nRBC ■ RBC ■ HGB ■ HCT ■ PLT ■ 5-Part Diff ■ Segmented neutrophils ■ Monocytes ■ Lymphocytes ■ Eosinophils ■ Basophils	1	Complete direct observation checklist for DxH 800 system and score 100%		
		2	Review of test results and critical value reporting.		
		3	Review QC results.		
		4	Completed direct observation for DxH 800 maintenance and maintenance documentation.		
		5	Successfully participate in CAP PT.		
		6	Complete problem-solving scenarios.		

Abbreviations

NCHS	National Center for Health Statistics
CAP	College of American Pathologists
CDC	Centers for Disease Control and Prevention
NHANES	National Health and Nutrition Examination Survey
MEC	mobile examination center
LPM	NHANES Laboratory Procedures Manual
U.S.	United States
CBC	complete blood count
ERB	ethics review board
QC	quality control
QA	quality assurance
IQAP	Interlaboratory Quality Assurance Program
PT	proficiency testing
CLIA	Clinical Laboratory Improvement Amendments of 1988
HCFA	Health Care Financing Administration (now referred to as the Centers for Medicare and Medicaid Services)
ISIS	Integrated Survey Information System
PC	personal computer
LAN	local area network
SP	survey participant

11.1 Start of Stand Activities

The Westat warehouse manager sends supplies for all stands, schedules shipments so that they arrive on or before setup day, and ships supplies requiring refrigeration to the local field office so that they arrive the day before setup. Laboratory supplies are stored in the laboratory cabinets or in the mobile examination center (MEC) trailer compartments.

The advance arrangement staff may assist in completing some setup activities. On setup day, the phlebotomists and medical technologists work together to complete all activities. These tasks include assisting in unpacking the warehouse pallets and boxes, sorting the laboratory supplies by storage location, completing an inventory of all existing and new supplies, organizing and storing all inventoried supplies in MEC cabinets or trailer compartments, and setting up each work area by stocking the area with appropriate supplies. Medical technologists and phlebotomists:

- Perform maintenance on and test the functionality of all instruments and equipment.
- Notify the MEC manager if additional supplies are required.
- Document all instrument and equipment malfunctions in the automated Unusual Field Occurrence utility.
- Mark and store miscellaneous hardware and original packing boxed in a safe location in the laboratory until the end of stand. Hardware includes wood blocks with Velcro (or split foam tubing), refrigerator and freezer bottle caps, restraining straps, and straps for the Beckman Coulter® DxH 800 instrument and printer.

Phlebotomy Room

- The phlebotomists' responsibilities include the following tasks:
 - Inventory consumables and non-consumables.
 - Check the sink for hot and cold running water and proper drainage.
 - Remove the wood block (or foam tubing) from the refrigerator door. (FES)
 - Unlock all cabinets.
 - Release the phlebotomy chair restraint.
- Pull up on the black lever on the lock and loosen just enough to separate the S bolts.
 - Turn on the refrigerator in phlebotomy. (FES)
 - Verify the refrigerator's operation.
 - Clean the refrigerator.
 - Check the function of the telephone intercom. (FES)
 - Clean all work surfaces and storage areas.
 - Stock and organize supplies.
 - Check the computer operations.
 - Store the chair restraint and the wood block in the bottom right drawer.

Laboratory

- Medical technologists' responsibilities include the following tasks:
 - Inventory consumables and non-consumables.
 - Add received dates to all reagents and supplies with expiration dates and/or lot numbers.
 - Check the sink and eyewash for cold running water and proper drainage; done by the facilities and equipment specialists (FES).
 - Install portable phone and Emergency Alert radio; done by FES.

- Check telephones operation; done by FES.
- Remove the wood door blocks from the refrigerators and freezers and store; done by FES.
- Replace the freezer temperature probe solid bottle caps with the caps with holes and save solid caps for reuse at the end of the stand; done by FES.
- Place the freezer temperature probes back into the bottles; done by FES.
- Power on the refrigerators and freezers; done by FES a week ahead.
- Verify freezer and refrigerator operation.
- Check light, blowers, and magnehelic pressure gauge reading in the Laminar Flow Biological Safety Cabinet (LFBSC).
- Remove and release the restraining strap on the Beckman Coulter® printer and store the straps until the end of the stand. (FES)
- Contact Beckman Coulter® at 1-800-526-7694 to schedule instrument verification by a service technician, at least 7 days prior to setup day. Provide the current address and instrument system ID.
- Perform all Beckman Coulter® beginning of stand operations as described in Chapter 6; this includes installing and priming all new reagents, performing a start-up procedure, and reviewing and verifying the system setup.
- Calibrate the Beckman Coulter® DxH 800. Complete the calibration, carryover, and repeatability studies prior to running the QC material. Verify that the instrument is working within acceptable parameters before performing routine CBCs on study participants (SPs). Unpack the Mettler Toledo scale and store the carrying case in an easily accessible area. Perform the QC on the Toledo Scale and complete the QC before performing routine urine flow rates on SPs.
- Assemble both centrifuges and perform maintenance as detailed in Section 13.5.
- Unpack and set up the vortex in the safety hood.
- Refrigerate the serum and urine pregnancy controls, and Beckman Coulter® Latron and 6C Cell controls as soon as they arrive.
- Clean and disinfect all work surfaces and storage areas.
- Stock and organize supplies.
- Clean the interior and exterior of refrigerators, freezers, centrifuges, and LFBSC.

- Open and label all new specimen containers using the laboratory application.
- Mentally step through labeling, blood processing, urine processing, pregnancy testing, complete blood count, and specimen storage to make sure all the necessary equipment is functioning and all supplies are available in the phlebotomy/laboratory area.
- Document all readings and activities in the Laboratory QC module.
- Call FedEx to check availability (1-800-463-3339).
- Duties by Workstation are presented in the following pages.

WORKSTATION 1

Setup

- Print inventory sheets.
- Count outside inventory (all incoming start of stand stock).
- Count, cut open, and store all shippers in the designated belly compartments.
- Organize the laboratory belly compartments.
- Fully stock the laboratory and assist in putting all supplies away.
- Place receive date stickers on all reagents, consumables with expiration and/or lot numbers.
- Rotate stock based on expiration dates.
- Open new specimen containers using the laboratory application and assign container IDs; print and adhere labels to containers store in refrigerators/freezers.
- Discard any laboratory-generated trash outside (i.e., boxes, plastic, etc.)
- Call FedEx and obtain the following information:
 1. The latest available time to call and schedule a pickup;
 2. Pickup window for the area;
 3. When are the last available pickup times Monday thru Friday, as well as the weekend; and
 4. Is there is a local facility accepting dangerous goods (i.e. dry ice for late dropoff)

- Make racks for the dry run session (with the assistance of the phlebotomist). For dry run SPs, put a yellow cryodot on when labeling the vessels for that session.
- Ensure that Workstation 1 is neat, clean, and organized in preparation for the start of examinations.

Daily

- Review session and prepare racks for each session (place all urine labels in workstation 3).
- Make any newly appointed SP racks or pull any rescheduled racks that have been added to the current session.
- Keep “Heads Up” session printout up to date.
- Process blood for first 45 minutes of each session.
- Make all racks for each upcoming session (through at least the first session after the upcoming weekend).
- Assist holding children in phlebotomy.
- Prepare for weekly shipping: make airbills and return packets.
- Keep workstation clean, organized, and stocked.

Weekly

- Ensure that there are enough frozen U-tek refrigerant packs for shipping.
- Wipe templates with Sani-Cloth Plus disposable wipes.
- Ensure that there are enough return shipment packets for shipping.

Shipping Day

- Work morning session in workstation 3.
- Pull and label shippers.
- Assign containers to shippers.
- Perform functions of the “*Outside person.*” Pack all frozen containers into shippers with dry ice.
- Have the evening session **OFF!**

End of Stand/Teardown

- Make Class 9 labels for the next stand.
- Print inventory sheets.
- End of stand inventory (outside, cabinets above workstation 1 computer, below the back counter, and high shelf above the centrifuges). Do not count reagents and consumable supplies that will expire before the next stand that this MEC will be operational.
- Prepare for the final shipment.
- Wipe templates with Sani-Cloth Plus disposable wipes.
- Assign containers to shippers.
- On Shipping Days perform functions of the “*Outside person*”: Pack all frozen containers into shippers with dry ice).
- Clean freezers #5 and #6.
- Tear down workstation (shutdown and secure computer, turn off the UPS, strap down printer, and unplug Dymo printer and scanner (store in phlebotomy bin), unplug zebra printer and store in original box under counter, and wipe down back countertop).
- Shred the remaining preprinted airbills.
- Lock all cabinets and drawers in the work area.
- Help strap down and secure refrigerators and freezers for transport.

WORKSTATION 2

Setup

- Count inventory in workstations 1 and 2.
- Assist in putting away new start of stand inventory.
- Place receive date on all reagents and consumables with expiration dates and/or lot numbers.
- Rotate stock based on expiration dates.
- Set up the laminar flow biological safety cabinet (LFBSC).

- Set up the centrifuges (apply paint-on graphite to buckets, grease the black cup rings, and wipe out the drums to remove excess oil).
- Set up pipettes, check settings on pipettes, esp. purple volumes.
- Set up the vortex in the LFBSC.
- Place new labeled specimen containers in refrigerators and freezers.
- Ensure that workstation 2 is neat, clean, and organized in preparation for the start of examinations.

Daily

- Report to work 45 min after the start of the session (with the exception of Dry Run- **everyone reports to work at 8:30 a.m.**).
- Process blood specimens (whole blood, plasma, and serum).
- Container mapping (**after each session**). Verify cryodots have been applied to dry run, guest and non-consented for future studies SP samples.
- Stay late to finish any processing if necessary
- At the end of each exam day, discard any MPA remaining in the 14-mL Falcon snap cap tube.
- Keep workstation clean, organized, and stocked.

Shipping Day

- Wrap all weekly or automatically closed whole blood and serum specimen containers for shipping.

End of Stand/Teardown

- End of stand inventory (cabinets below centrifuges, below hood, and below workstation 2 computer). Do not count reagents and consumable supplies that will expire before the next stand that this MEC will be operational.
- Clean Eppendorf Pipettes.
- Tear down and clean centrifuges.
- Wipe down the mini vortex with a Sani-Cloth Plus; store for transport.
- Tear down and clean the laminar flow hood.
- On Shipping Days perform functions of the “*Inside Person*”: Pack up all refrigerated shippers and HPV swabs; assemble frozen packages for outside shipping person).

- Clean freezer #4 and refrigerator #2.
- Tear down workstation (shut down and secure computer, turn off the UPS, strap down printer, unplug Dymo printer and scanners (store in phlebotomy bin) and wipe down workstation countertop).
- Help strap down and secure refrigerators and freezers for transport.
- Lock all cabinets and drawers in the work area.

WORKSTATION 3

Setup

- Set up the Beckman-Coulter service call before arriving at the next stand (Rep should “wet the analyzer” and adjust the Flow Cell, if needed).
- Count old inventory in workstation 3.
- Place receive date on all reagents and consumables with expiration dates and/or lot numbers.
- Rotate stock based on expiration dates.
- Put away all new inventory.
- Set up and calibrate the DxH 800.
- Set up the scale.
- Perform Start of Stand QC and enter into **“Start of Stand”** module in ISIS.
- Perform Start of Stand maintenance on DxH and record actions on log.
- Obtain new Hematology Troubleshooting Log and DxH Maintenance log from blank forms from LAB section in ISIS Network> Staff>Lab..
- Ensure that all freezers have antifreeze and are wiped free of dust and dirt from traveling.
- Ensure that the workstation is neat, clean, and organized in preparation for the start of examinations.

Daily

- Make ascorbic acids (1% and 7%) and prepare 6% MPA for daily use by transferring 8-mL of the MPA reagent from the 50-mL Falcon tube to a 14-mL Falcon snap cap tube. Keep the remainder of the solution in the 50-mL Falcon tube refrigerated.

- Verify Daily Checks on DxH 800 and Run and Review QC (**1st Session:** Latron and 6C controls; **2nd Session:** 6C controls only).
- Perform pregnancy QC and record results in the “**Pregnancy QC**” module.
- Enter Daily QC in “**Daily QC**” module in ISIS (scale weights, laminar flow hood pressure, humidity, and room temps).
- Review and initial printed Daily Checks printout.
- Weigh and process urines (as they are brought into the laboratory).
- Perform urine pregnancy tests ASAP.
- Run CBCs.
- Process VOC, , and male and female HPV swabs.
- Container mapping (**after each session**).
- Keep workstation clean, organized, and stocked.
- Log off DXH at the end of the day

Weekly

- Reconstitute 6% MPA in 50-mL water once every 7 days (store in refrigerator).
- Perform and enter Weekly QC into “**Weekly QC**” module in ISIS.
- Transmit Coulter QC into ISIS.
- Wash all racks (Nalgene cryovial racks and Nalge 13mm and 16 mm half racks), centrifuge cups, and rocker pads at the end of the week.
- Perform weekly DxH maintenance.

Shipping Day

- Have the morning session **OFF!**
- Come in at 12:15 p.m. and help wrap any containers, if applicable.
- Shipping: “**Inside Person**”: Pack up all refrigerated shippers and HPV swabs; assemble frozen packages for Outside Shipping Person).
- Call FedEx and schedule a pickup.
- Label new containers and put them into their respective freezers or refrigerators.

- Wait for the scheduled FedEx pickup.
- Work the evening session.

End of Stand/Teardown

Schedule Extended Shutdown with Coulter at least one week prior to teardown.

- Follow the DxH End of Stand Instructions (Print off all graphs, QC, transmit, clean analyzer, etc.).
- Prepare End of Stand FedEx Box to be sent to the lab component study manager at the home office.
- Prepare box(es) of miscellaneous supplies to be returned to warehouse (CJ).
- Conduct end of stand inventory of supplies in work area. Do not count reagents and consumable supplies that will expire before the next stand that this MEC will be operational.
- Wash EVERYTHING, including all racks (Nalgene cryovial racks and Nalge 13 mm and 16 mm half and full racks), centrifuge cups, and rocker pads, and all Tupperware.
- Unplug scale, clean platform and remove. Place cone on platform head. Place all in hard case, and then store case in a cabinet.
- Clean freezer #3 and refrigerator #1.
- Help ship by assisting in the packaging of refrigerated specimens.
- Inform chief technologist of any reagents that are needed for startup for the next stand.
- Tear down workstation (shut down and secure computer, turn off the UPS, strap down printer, unplug Dymo printer and scanners (store in phlebotomy bin) and wipe down workstation countertop).
- Be available for the Extended Shutdown of the DxH by the Beckman Coulter representative.
- Strap down and secure the DxH as well as the DxH computer.
- Lock all cabinets in the work area.

NCHS biomedical engineer (annual) responsibilities include the following tasks:

- Determine the rpm of the centrifuges using a strobe or tachometer.
- Perform a timer check.

- Verify that both centrifuges are operating at 4-8°C.
- Enter the results in the Laboratory QC module.

11.2 End of Stand Activities

At the end of a stand, shut down all equipment and inventory all supplies. Ensure that there is at least one unopened container of Diff Pack, Lyse, cleaner and 2 Coulter diluents remaining on board for the start of the next stand. On teardown day, the phlebotomist and medical technologists work together to complete all activities. Carefully wrap all breakable supplies in preparation for the move. Lock all cabinets and drawers. Safely discard all biohazardous waste. Repack the Mettler Toledo scale in the blue carrying case.

Packing Phlebotomy Room

- Phlebotomists' responsibilities include the following tasks:
 - Inventory consumables and non-consumables.
 - Discard and do not inventory any consumable—including Vacutainer® vials – that will expire before the next stand of this particular MEC.
 - Turn off and clean the refrigerator in the phlebotomy room.
 - Place wood blocks with Velcro strips on the refrigerator doors to prevent the doors from closing or moving. Be careful not to damage the rubber gasket on the door.
 - Pack all juice and crackers in drawers.. Discard any loose juices (not in original 8 pack wrapping). Discard and do not inventory any juice packs or crackers that will expire before the start to the next stand for that particular MEC.
 - Remove all loose supplies (clock, telephone handset, etc.) and equipment from the countertops; pack loose supplies in the cupboards above the counter. If these areas are full, place the boxes in the designated compartments under the trailers. Do not store Vacutainer® tubes in these trailer compartments.
 - Bolt the room doors in the open position.
 - Close and lock all cabinets.
 - Lock all needles in the cabinets.

- Restrain the phlebotomy chair.
 1. Attach the S bolt on the end of the orange belt to each of the two wall brackets (under the drop-down chair).
 2. Attach the center S bolts to each other in the center of the orange belt.
 3. Tighten the belt by pulling on the free end of the belt.

Packing the Laboratory

- **Medical technologists' responsibilities include the following tasks:**
 - Close and ship all containers to appropriate contract laboratories.
 - Inventory consumables and non-consumables. Discard and do not inventory any consumables that will expire before the next session of this MEC. This may be done 1-2 days prior to teardown, if usage on the last days is accounted for.
 - Perform the Beckman Coulter® end of stand procedures as described in Chapter 6; these include the following:
 - Review and then export to a CD the Event, Data Summary, Maintenance, and Audit logs on the Coulter. Clear the logs after exporting.
 - Review and then export the IQAP files to a second CD.
 - Print Latron and 6C Cell control cumulative statistics (files) and graphs.
 - Export Patient Log (Database) to a third CD.
 - Clean the DxH aspiration probe and STM.
 - Clean exterior of the instrument and handheld bar code scanner using Sani-Cloths.

Check the expiration dates on the Beckman Coulter® Latron, Beckman Coulter® 6C Cell control, pregnancy test kit, and pregnancy controls. If unopened and they will not expire before the beginning of the next stand, pack them in a shipper with refrigerant packs, print a label using FedEx Ship, and ship back to the warehouse.

- Turn off the centrifuges.
- Turn off printers.
- Shut down all computers using the desktop computer X-shutdown icon.
- Turn off all uninterruptible power sources (UPS).

- Turn off all freezers and refrigerators by flipping the corresponding wall switch to the left of the units. Turn off after all shipping is complete.
- Clean refrigerators and freezers with Sani-Cloths or Bleach Rite solution.
- Replace the refrigerator temperature probe bottle caps (with holes), with the bottle caps without holes, and save the caps with holes for reuse at the start of the next stand. Place the glycerin temperature probe bottle in the sink. Clean the temperature probes and wrap securely with terri wipes. Leave probes securely in place.
- Place wood blocks with Velcro strips or foam inserts on each refrigerator and freezer door to prevent the door from closing or moving. Be careful not to damage the rubber gasket on the door.
- Turn off the Mettler Toledo scale. Disconnect the scale from the tan serial cable and black AC adapter power cord. Tape the serial cable and power cord to the countertop. Repack the Mettler Toledo scale in the blue carrying case, making sure to remove and store the weigh pan in the lid of the carrying case, and cover the scale cone with the plastic cone protector. Store the carrying case in one of the cabinets.
- Disinfect and clean the pipettes. See Section 11.12 for detailed instructions.
- Clean and power down the LFBSC; refer to Section 11.8.
- Remove centrifuge rotors, clean and pack in foam-lined bins. Remove and clean metal rotor buckets and store in same foam-lined bin. Clean and store in a drawer the plastic Aerosolve Canisters and sample holders. Clean interior and exterior of centrifuges. Close centrifuge lids and turn off centrifuges.
- Pack all tube rockers and Zebra printer securely in boxes.
- Power down and secure with a strap the HP printer in workstation 1.
- Remove all small supplies from the counters and LFBSC and pack in boxes or cabinets. Store mini vortex in original box keeping with other like items.
- Disconnect all bar code readers and Dymo label printers. Store in plastic bin in phlebotomy room.
- Tape to counter or clip all computer cables to secure.
- Power down computers using the “X-Shutdown” icon under utilities.
- Remove the clock from the wall. Remove the battery and tape it to the back of the clock. Place clock in available space in drawer.
- Cover computers with padded sleeves and strap with bungee cord to the wall, placing the monitor and mouse securely inside the straps against the padding.

- Close all cupboards and drawers and then lock.
- Clean all counters, the LFBSC, and equipment with 1:10 bleach solution.
- Remove all trash, and place regular waste cans flat on their side under a counter. Remove all biohazard waste.
- Place chairs upside down or lay them down on the floor.
- After DxH has been decontaminated by Coulter FSE, attach strap around the bottom front of the DxH 800. (Do not apply too much pressure.)
- Secure the Beckman Coulter® printer by strapping it to the printer shelf.

Sending Laboratory Files and Supplies

At the end of each stand, use FedEx to create a label to send the following hard-copy documentation to the study manager of the laboratory component at the home office and place a printout cover sheet for each bulleted item listing its contents:

- Beckman Coulter® Latron and 6C Cell Control cumulative statistic and graph printouts.
- Beckman Coulter® Daily checks printouts.
- Beckman Coulter® Calibration, repeatability and carryover printouts.
- Beckman Coulter® Linearity printouts.
- Proficiency testing copies (hematology, urine, and serum hCG).
- CD Discs with IQAP, Event logs, and SP data.
- Insert sheets for Coulter QC, Latron, and Calibration materials.
- Troubleshooting Log (make a copy and keep it with the instrument log book).

At the end of each stand, use FedEx to create a label to send the following supplies to the warehouse supervisor using the “Transfer Inventory to Warehouse Manifest”:

- Unopened pregnancy test kits.
- Unopened pregnancy urine controls – refrigerated.
- Unopened pregnancy serum controls – refrigerated.

Pack supplies using procedures described in Chapter 8.

11.3 Inventory Procedures and Supplies

At the start and end of each stand, take a complete inventory. The warehouse uses this inventory to stock the MEC for the next stand.

The equipment and supplies associated with the MEC laboratory are listed in Exhibit 11-1, Equipment and supplies.

Exhibit 11-1. Equipment and supplies

Four Revco freezers ULT 430A18	Laminar flow biological safety cabinet
Two Beckman Coulter Allegra X-15R centrifuges	One Jewett refrigerator (phlebotomy)
	Mettler Toledo scale
One solar wall thermometers (lab)	One solar wall thermometer (phlebotomy)
Two Jewett refrigerators UC5B	Thermometer (centrifuge calibration)
TempGuard monitoring system	Humidity monitor

Store supplies in the trailer compartments.

11.3.1 General Inventory Procedures

- Since item units can change, verify the “unit of measure” each time you record a count. Examples of units are pack, each, bag, box, case, roll, tray, bottle, pair, and pouch.
- Do not redefine or reiterate the Unit of Measure.
- “Par level” represents the number of units with which the component is to begin a stand. Par levels are set and adjusted by home component staff only. All recommendations to adjust an item’s par level should be directed to the home component staff.
- Do not write any notes, comments, etc. on the Start-of-Stand Inventory Count Sheets or the End-of-Stand Inventory Count Sheets. Write comments or concerns on a separate sheet of paper and attach it to the inventory sheet.
- Rotate items by first using what you have in the rooms, then items in the belly compartment. Place items you just received in the back of the stock, unless you need them immediately. When you are out of items in your room, restock your rooms only with items that were just shipped to the stand. Many items such as gloves, alcohol prep

pads, Sani-Cloth wipes, and blood tubes deteriorate over time. Always use inventory with the closest expiration date first.

- Multiple inventory items onboard the MEC contain lot numbers and expiration dates. When performing physical inventory counts, pay close attention to these items and mark inventory sheets accordingly for each lot number/expiration date per item.
- Do not count reagents and consumable supplies that will expire before the next stand that this MEC will be operational.
- Do not purchase items listed on the inventory sheets. Every item listed on the inventory sheet is supplied by the NHANES Warehouse. Purchasing items locally creates chaos with the Inventory Management System.
- Do not borrow items from other components. Any additional inventory needed by a component should be requested from the NHANES Warehouse. Inventory usage is tracked by component. The “Counted By” tech ID is entered into the database to track inconsistencies and trends. Everyone is accountable for his or her component counts.

11.3.2 End of Stand Inventory Procedures

The End of Stand Inventory Count Sheet (EOSCS) includes the stand number, Site ID (MEC number), a “Counted By” line, and Exam Supply columns for item number, general item description, Unit designation, par level, and a count box. The MEC manager prints these EOSCSs for every component. **The MEC staff is responsible for accurately counting (inventorying) exam supplies and entering this number into the count box.** The MEC staff gives the completed sheets back to the MEC manager who sends them to the warehouse manager. The warehouse manager enters the item counts into the Inventory Management System.

- Print only one name in the “Counted By” field. This is the person responsible for taking and verifying the inventory count. Please write legibly for all counts.
- Place a number in each “count” box. **Do not leave any count box empty.** If there is no stock remaining for a specific item, enter a “zero” in the count box.
- Do not count partial units; record only whole numbers in the count box. **Do not** write entries such as: ½, partial, some, many, a few, couple, .5, or multiple.
- If the PAR for an item is more than one (1) and the “unit of measure” is open, do not count that container. Count only the remaining number of items that have not been opened.

- If the PAR for an item is only one (1) unit and it is more than half empty, enter a zero (0) in the count box. A full unit will be supplied to the component at the opening of the next site.
- All active lot numbers and expiration dates are listed on the inventory count sheets if they are applicable for that item. Record the number of supplies remaining for each lot number/expiration date in the count box. If there is no inventory remaining for a listed lot number/expiration date, enter a “zero” in the count box.
- Any item that has expired during the MEC site, or will expire before the MEC re-opens at its next location, should be removed from the component. If an item is removed, a “zero” should be entered in the count box on the End of Stand Inventory Count Sheet for that item. A Delete/Expired Inventory Count Sheet must be filled out, per component, showing the quantity for each item removed from the component. This additional inventory sheet must be attached to the End of Stand Inventory Count Sheet for that component when turned into the MEC manager.

11.3.3 Mid-Stand Inventory Procedures

Mid-Stand Inventory is performed by each component on the MEC, approximately 2-2½ weeks into an operating site. A schedule of the appropriate order and delivery date for midstand inventory will be noted on each stand’s calendar by the chief technologist. This date will be set by the warehouse and approved by the laboratory component manager. This inventory provides the opportunity for MEC staff to request additional supplies from the warehouse that will be needed to complete the current MEC site. The Mid-Stand Inventory is conducted via UFO entry (per component).

NOTE: The Mid-Stand Inventory is only to provide additional supplies needed to complete the current site; it is not designed to bring all supplies up to full par level.

- Each component is to review all remaining inventory to determine if additional supplies are needed to complete the current MEC site.
- A “UFO” will be entered (sighted) by one MEC staff member per component.
- MEC staff will enter a “UFO” by component name and then use “Inventory/Supplies” for the type of UFO entry.
- In the description field, the MEC staff member will request the supply(s) needed for the component.
- Entries are to be made as item description, then quantity requested (per item).

- If no additional supplies are needed for the component, write “Nothing Needed” in the description field.
- **Do not** request items in the UFO that are not on the component inventory list.
- **Do not** request changes to set par levels in mid-stand UFOs.
- **Do not** enter equipment issues in a UFO listed as “Inventory/Supplies.”
- All completed UFO entries will be reviewed by the MEC manager for that MEC before the warehouse will pull and ship supplies requested.
- Once the supplies have been pulled by the warehouse and packed for shipping to the MEC, the warehouse manager will finalize the UFO.

11.3.4 Start of Stand Inventory Procedures

The Start of Stand Pull Sheets (SOSPS) include the stand number, Site ID (MEC number), and Exam Supply columns for part number, general item description, Previous EOS Count number, par level, Unit designation, and a Ship to Stand box. The warehouse manager uses this report to bring each item back to par level. For example, if the Previous EOS Count (captured by the IMS) is four and the Par level is five, the Ship to Stand count box will contain the number one. The warehouse manager prints and packs one pull sheet for each component. **The MEC staff is responsible for accurately reconciling the supplies and numbers in the SOSPS.** The MEC staff gives the completed sheets back to the MEC manager who returns them to the warehouse manager. The warehouse manager reviews each sheet and sends additional supplies to the field if necessary.

- Reconcile the inventory for each item.
- Verify the Previous EOS Count for each item.
- Verify that the start of stand shipment contains the exact number of each item listed in the Ship to Stand box.
- Previous EOS Count added to the Ship to Stand Count box should equal par level.
- If the total inventory equals the set par level, place a checkmark on the right side of the Ship to Stand Count Box (per item).
- If there is a discrepancy, write the physical count on hand to the right of the Ship to Stand Count box (per item).
- If the quantity for an item is higher than the set par level, the excess should be removed from the component (leaving par) and returned to the warehouse. If an item(s) is being

returned to the warehouse, have the MEC manager print a “Transfer Inventory to Warehouse Count Sheet” for the component. Print your name on the inventory sheet. Mark only the quantities for item(s) that are being returned. Give the excess inventory and the “Transfer Inventory Sheet” to the MEC manager to ship supplies back to the warehouse.

11.3.5 Consumables vs. Non-consumables

Inventory items are divided into two categories—consumable and non-consumable. Inventory both types of items during each inventory. A consumable item is anything that is typically consumed during an examination. A non-consumable item is one that can be used more than once (*example: stopwatches, test tube racks, safety glasses, storage boxes*). There are times when non-consumable items will need to be replaced. These instances would include items that are used in an emergency, when the item expires, or when the item breaks (*example: physician medical kit supplies, stopwatches, thermometers, CPR masks*).

11.3.6 Shipping Excess Inventory Back to the Warehouse

When shipping excess inventory back to the warehouse, please use the “Transfer Inventory to Warehouse Manifest” which is found on the Portal and can be printed by the MEC manager. This form looks similar to the “End of Stand Count Sheets.” Print your name in the “Counted By” field and mark only the items (with quantity being returned) in the count boxes that are being shipped back to the warehouse. Give the items to be returned along with the “Transfer Inventory to Warehouse Inventory Sheet” to the MEC manager to ship back to the warehouse. This information is entered into the Inventory Management System by the warehouse manager and is used to adjust the stand inventory and usage information and to increase the warehouse inventory counts.

11.3.7 Tracking Expired and Broken Inventory

Complete the “Delete Expired/Broken Inventory Report” whenever inventory has expired and must be destroyed or has broken and is no longer usable. Print your name in the “Counted By” field and mark only the item(s) in the count box that have expired or broken, and which are being removed from the MEC. This report is found on the Portal and should be completed and forwarded to the warehouse manager so that the expired or broken inventory can be removed from the stand

inventory. Unless the item is a tool (piece of equipment), under most circumstances it can be disposed of in the field and there is no need to return it to the warehouse. Check with the MEC manager or call the warehouse manager to verify the need to ship the expired/broken item back to the warehouse.

The chief medical technologist and the phlebotomist are responsible for notifying the MEC manager if additional supplies are needed during the stand. However, each technologist and phlebotomist is responsible for identifying any potential shortage of supplies at each workstation. Contact the warehouse manager directly at 301-212-3759.

11.4 Dry Run

After setting up the phlebotomy and laboratory rooms at each new stand, the staff conducts a “dry run” session using volunteers to verify data and specimen collection and processing procedures. One purpose of the dry run session is to help identify any problem areas, particularly with equipment, and to resolve the problems before the stand begins. Another purpose is to provide the contract laboratories with blind split samples for quality control determinations. Two distinct IDs are assigned to each volunteer—the original SP ID and a second unique Sample ID. Document the results of the dry run session the same way as an actual session except enter the results twice, first using the SP ID, and second using the Sample ID.

Procedures

- Collect the amount of blood specified in the Dry Run Venipuncture Protocol. This amount is less than the blood required from a routine examinee.
- Prepare split samples for each volunteer.
 - Collect 6-ml of urine and process as specified in Dry Run Urine Processing Protocol. Process the blood as directed in the protocols Store these split samples and ship them to contract laboratories for analysis with the first routine shipment.

11.4.1 Phlebotomy Protocol and Procedures

The dry run venipuncture protocol (Exhibit 11-2) is dependent on the last digit in the SP ID. If the last digit is an odd number, the volunteer’s protocol includes four 4-ml EDTA, two 2-ml gray, and

two 15-ml red-top tubes. If the last digit is an even number, the volunteer's protocol includes two 4-ml EDTA, two 2-ml gray, and two 15-ml red-top tubes.

Exhibit 11-2. Dry run venipuncture protocol

Tube type (in priority order)	Last digit in SP ID = Odd	Last digit in SP ID = Even
4-ml EDTA	4	2
2-ml gray	2	2
15-ml red	2	2

On dry run day, the phlebotomist refers to the following instructions to conduct the phlebotomy procedures:

- Access the phlebotomy application; open the exam, and wand the dry run volunteer into the component.
- Conduct the phlebotomy interview and administer the fasting questionnaire as described in Chapter 3.
- Perform the venipuncture using procedures described in Chapter 3.

The last digit in the SP ID determines the dry run volunteer's venipuncture protocol. The correct venipuncture automatically displays. Note that there are two IDs—an SP ID (110355), and a Sample ID (616625). Both IDs display under the "Obtained all" check box.

train-05

Phlebotomy: Stand:615 Session:615100 09/05/2010 08:30 am - 12:30 pm

SP ID: 440292 Name: HILPERT, RICH Age: 45 years Gender: Male Date: 01/17/2013 Time: 04:32 PM

Venipuncture

4 ml lavender 2 of 2

2 ml gray 2 of 2

15 ml red 2 of 2

Obtained all

440292

138976

Comment:

Enter the venipuncture results using procedures described in Chapter 3. Enter any reasons for a tube not being drawn according to protocol, and any comments about the venipuncture. Refer to Chapter 3 for specific instructions.

Label the Vacutainer® tubes for each volunteer; label half of the tubes with the SP ID and the other half with the Sample ID. If only one tube is drawn, discard it. If less than two of the 15-ml red tubes are successfully drawn, label the first tube with the original SP ID and the second one with the Sample ID. If an odd number of tubes are drawn, discard the odd tube.

For dry run volunteers with the SP ID and Sample ID ending in an odd number:

- Place one label with the original SP ID on two of the four 4-ml EDTA tubes and the other labels with the Sample ID on the other two 4-ml EDTA tubes.
- Place the label with the original SP ID on one tube of the pair of 2-ml gray tubes and the label with the Sample ID on the other 2-ml gray tube.
- Place the label with the original SP ID on one of the two 15-ml red tubes and the label with the Sample ID on the other 15-ml red tube.

For dry run volunteers with the SP ID and Sample ID ending in an even number:

- Place one label with the original SP ID on one of 4-ml EDTA tubes and the other label with the Sample ID on the other 4-ml EDTA tubes.
- Place the label with the original SP ID on one tube of the pair of 2-ml gray tubes and the label with the Sample ID on the other 2-ml gray tube.
- Place the labels with the original SP ID on two of the four 15-ml red tubes and the labels with the Sample ID on the other two 15-ml red tubes.

11.4.2 Urine Processing and Pregnancy Testing

Access the laboratory application and logon using the MEC Logon window.

SP ID	Sample ID	Status	Type	Gender	Age	Name	Process Status							
							UC	U	P	CB	B	PC	F	M
440292	138976	CI	D	M	45	HILPERT, RICH	-	<input type="radio"/>	-	<input checked="" type="radio"/>	<input checked="" type="radio"/>	-	-	-
440292	440292	CI	D	M	45	HILPERT, RICH	<input checked="" type="radio"/>	<input type="radio"/>	-	<input type="radio"/>	<input type="radio"/>	-	-	-
449811	131529	CI	D	M	49	BROWN, JOHN	-	<input type="radio"/>	-	<input type="radio"/>	<input type="radio"/>	<input type="radio"/>	-	-
449811	449811	CI	D	M	49	BROWN, JOHN	<input checked="" type="radio"/>	<input type="radio"/>	-	<input type="radio"/>	<input type="radio"/>	<input type="radio"/>	-	-

Two distinct IDs are assigned to each volunteer—the original SP ID and a second unique Sample ID.

Place urine and pregnancy labels at workstation 3. Each volunteer has two unique blood processing racks—one with labels containing the SP ID and the second with labels containing the Sample ID.

Assemble and label the blood processing racks for each dry run volunteer using procedures described in Chapter 8.

Review the laboratory heads-up display. Use the heads-up display to view the modules for which the dry run volunteer is eligible and the current process status.

The screenshot shows a software window titled "Lab Subsystem" with a menu bar (File, View, Utilities, Quality Control, Reports, Modules, Shipping, Window, Help) and a toolbar. The main area contains a table with the following data:

SP ID	Sample ID	Status	Type	Gender	Age	Name	Process Status						HPV	
							UC	U	P	CB	B	PC	F	M
440292	138976	CI	D	M	45	HILPERT, RICH	-	○	-	○	○	-	-	-
440292	440292	CI	D	M	45	HILPERT, RICH	○	○	-	○	○	-	-	-
449811	131529	CI	D	M	49	BROWN, JOHN	-	○	-	○	○	○	-	-
449811	449811	CI	D	M	49	BROWN, JOHN	○	○	-	○	○	○	-	-

The heads-up display lists each dry run volunteer twice. Note the difference between the SP ID and the Sample ID and the types of tests for which the dry run volunteer is eligible. Dry run volunteers with an SP ID and Sample ID ending in either an odd or even digit are eligible for urine collection and processing, CBC, blood processing, and the pregnancy test (if female.) The urine and blood protocols constitute a limited subset of the primary SP's test protocol. Each test has the same age and gender restrictions as a primary SP. Notice that one urine collection result and one pregnancy test are required for each dry run volunteer when the SP ID and Sample ID end in an odd or even digit.

Collect 6-ml urine from all dry run volunteers. The MEC coordinator instructs each volunteer to void as soon as he or she feels able to provide a urine specimen. The coordinator or local assistant transports the initial specimen to the laboratory. All dry run volunteers are eligible for at least one urine test.

Place the urine collection cup on the scale and scan in the urine collection specimen bar code as described in Chapter 4, Section 4.4.

Document the urine collection in the laboratory application.

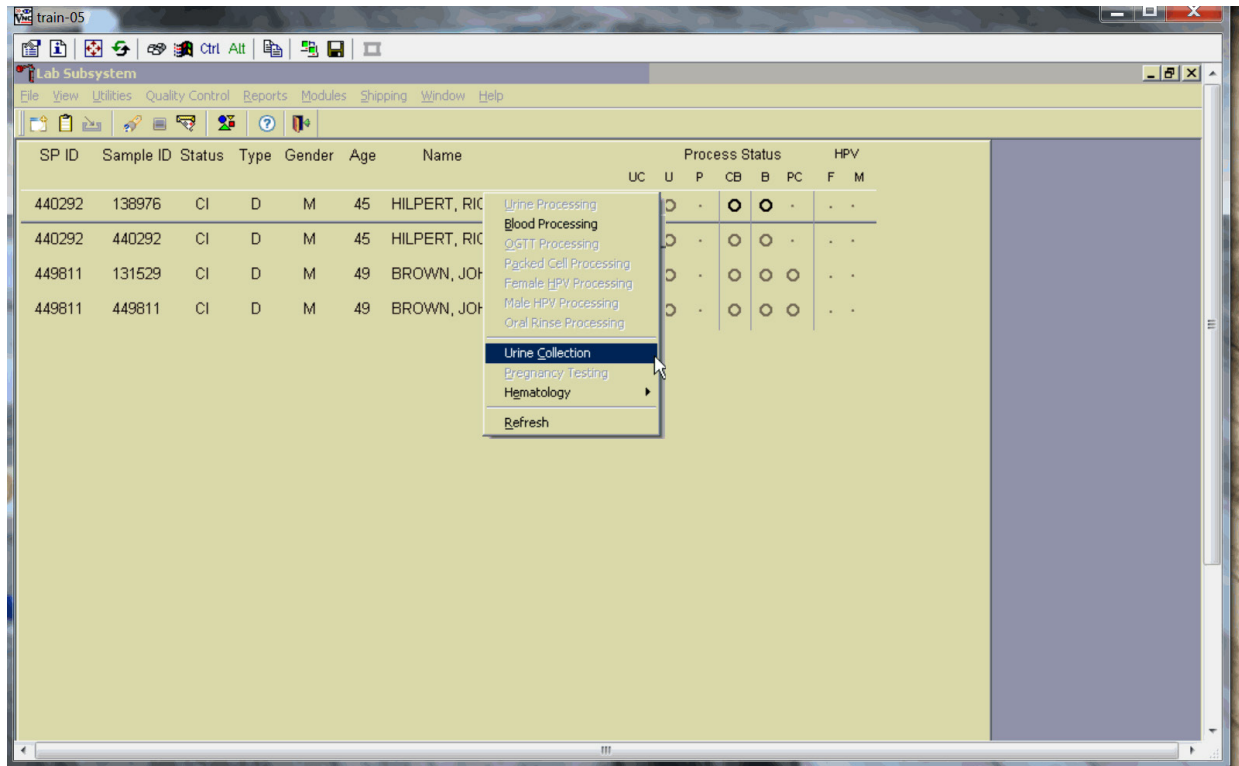

To select the correct dry run volunteer's record, locate the record in the heads-up display that contains the urine collection circle. To access the urine collection module, use the up and down keys to move up and down the list until the correct record is highlighted or drag the mouse arrow to the correct volunteer and right-click. Continue by dragging the mouse arrow to {Urine Collection}, then left-click.

The urine collection window displays.

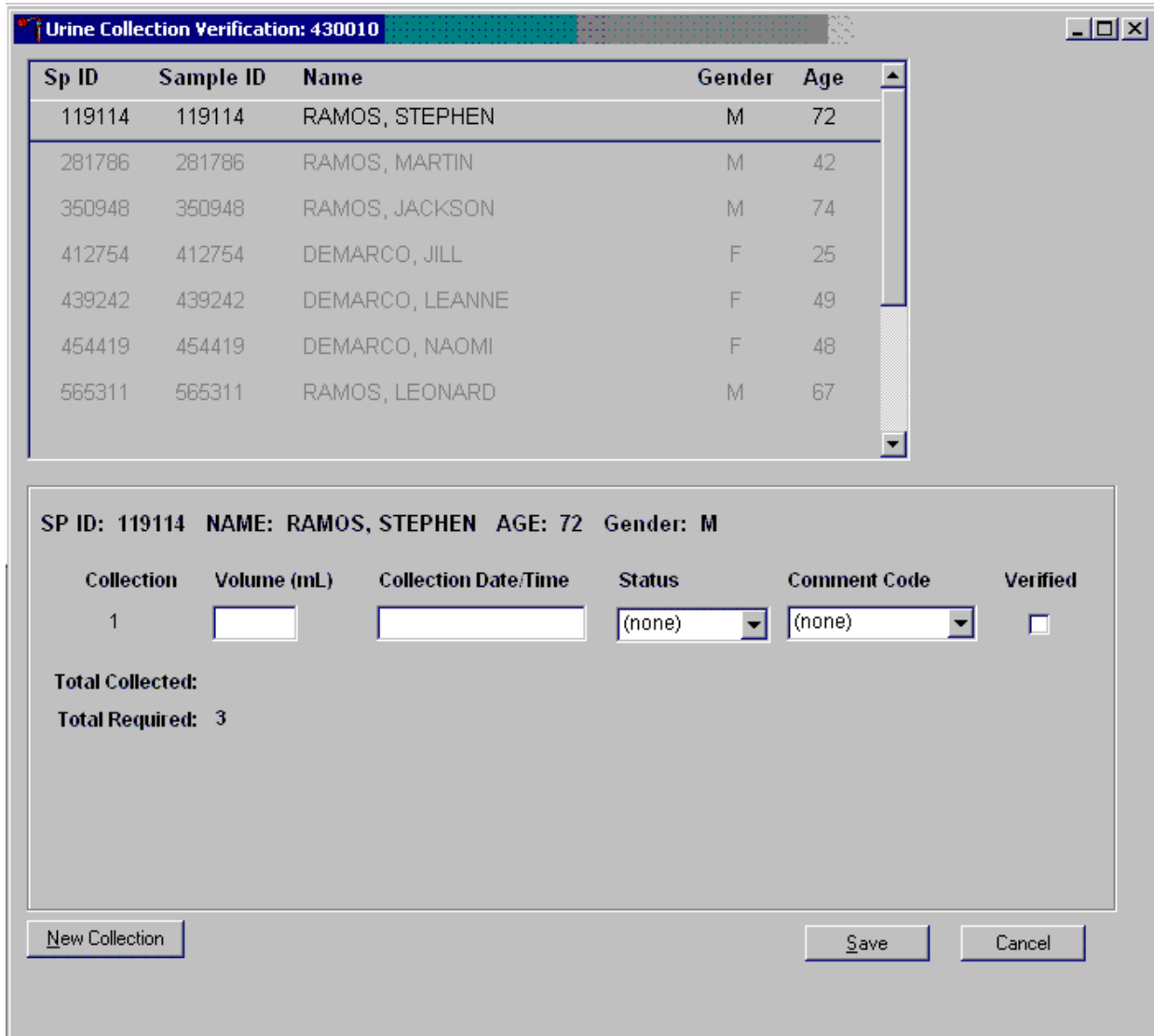

The top of the urine collection window contains columns for the SP ID, Sample ID, person name (last, first), gender, and age. The row for checked-in SPs is indicated in black, while SPs who have not checked into the MEC session are gray. Only dry run volunteers who have checked into the MEC session are available for processing. SPs who have a urine collection ready for verification display in blue. Use the scroll bar to view all SPs scheduled into the session.

Verify the sufficiency of the quantity of urine received in the laboratory. Use the measuring tool to verify the amount of urine reported from the scale.

Sp ID	Sample ID	Name	Gender	Age
119114	119114	RAMOS, STEPHEN	M	72
281786	281786	RAMOS, MARTIN	M	42
350948	350948	RAMOS, JACKSON	M	74
412754	412754	DEMARCO, JILL	F	25
439242	439242	DEMARCO, LEANNE	F	49
454419	454419	DEMARCO, NAOMI	F	48
565311	565311	RAMOS, LEONARD	M	67

SP ID: 119114 NAME: RAMOS, STEPHEN AGE: 72 Gender: M

Collection	Volume (mL)	Collection Date/Time	Status	Comment Code	Verified
1	138	12/13/2008 09:30 AM	Yes	(none)	<input type="checkbox"/>

Total Collected: 138
Total Required: 3

Buttons:

If the SP has submitted a urine collection that has been weighed and scanned into the database, the volume, collection status, and collection date and time will automatically display in the lower portion of the urine collection screen.

If the collection did not meet the minimum protocol requirement, the application will automatically insert “QNS” in the Status result text field and “quantity not sufficient” in the Comment Code text box.

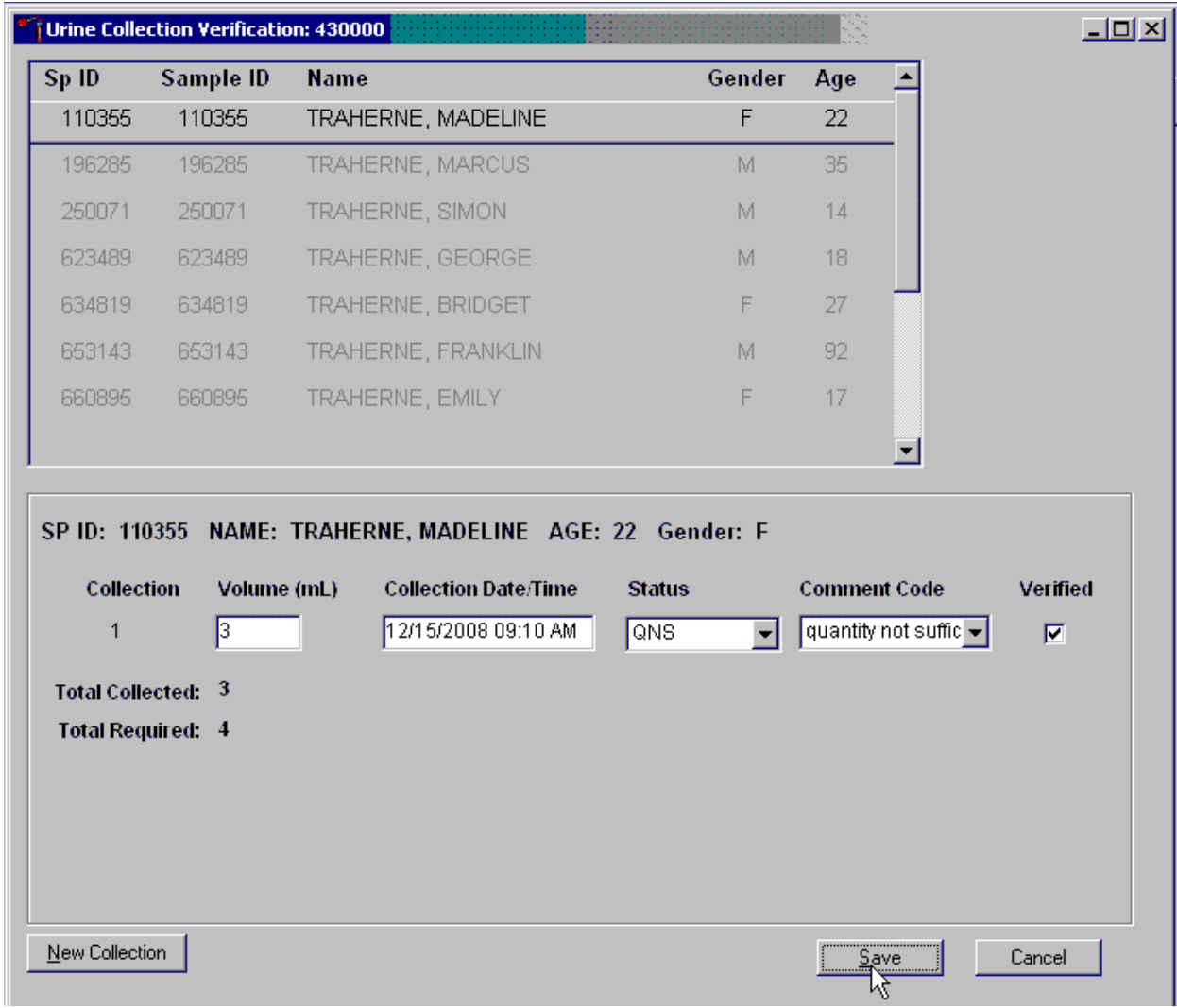

A QNS status immediately prompts and notifies the coordinator to ask the SP for an additional urine sample.

A second instance of urine collection for the first QNS sample or third instance of urine collection for the second QNS sample will appear below the current sample.

Urine Collection Verification: 430000

Sp ID	Sample ID	Name	Gender	Age
110355	110355	TRAHERNE, MADELINE	F	22
196285	196285	TRAHERNE, MARCUS	M	35
250071	250071	TRAHERNE, SIMON	M	14
623489	623489	TRAHERNE, GEORGE	M	18
634819	634819	TRAHERNE, BRIDGET	F	27
653143	653143	TRAHERNE, FRANKLIN	M	92
660895	660895	TRAHERNE, EMILY	F	17

SP ID: 110355 NAME: TRAHERNE, MADELINE AGE: 22 Gender: F

Collection	Volume (mL)	Collection Date/Time	Status	Comment Code	Verified
1	3	12/15/2008 09:10 AM	QNS	quantity not suffic	<input checked="" type="checkbox"/>
2	25	12/15/2008 10:30 AM	Yes	(none)	<input type="checkbox"/>

Total Collected: 28
Total Required: 4

New Collection Save Cancel

If the quantity of urine collection meets the requirement of the urine protocol, the application will automatically select a status of “Yes,” and no additional collections will appear.

Evaluate the quantity of urine received in the laboratory. Compare the number displayed in the Total Collected line and the actual volume of urine in the cup.

Urine Collection Verification: 430000

Sp ID	Sample ID	Name	Gender	Age
110355	110355	TRAHERNE, MADELINE	F	22
196285	196285	TRAHERNE, MARCUS	M	35
250071	250071	TRAHERNE, SIMON	M	14
623489	623489	TRAHERNE, GEORGE	M	18
634819	634819	TRAHERNE, BRIDGET	F	27
653143	653143	TRAHERNE, FRANKLIN	M	92
660895	660895	TRAHERNE, EMILY	F	17

SP ID: 110355 NAME: TRAHERNE, MADELINE AGE: 22 Gender: F

Collection	Volume (mL)	Collection Date/Time	Status	Comment Code	Verified
1	3	12/15/2008 09:10 AM	QNS	quantity not suffic	<input checked="" type="checkbox"/>
2	25	12/15/2008 10:30 AM	Yes	(none)	<input type="checkbox"/>

Total Collected: 28
Total Required: 4

Adjust the Volume (ml) if necessary by directing the mouse arrow to the text box under the Volume (ml) column. Right-click on the text box to enable the cursor. Make changes using the number pad on the keyboard. Once any necessary adjustments have been made, direct the mouse arrow to the box under the Collection Date/Time column or press the Tab key.

A prompt will pop up asking if you would like to subtract the weight of the cup. If the volume of the sample was transmitted from the scale and you have made a manual adjustment to that reading, select "No."

Do not enter a result until urine arrives in the laboratory. At the end of each session, review the results for each dry run volunteer. Enter "No" in the Status Result Field for all volunteers who have

not produced a urine sample. Record a result other than “(none)” for all records. Record a comment for all insufficient urine collections.

The laboratory application will automatically assign the comment code “quantity not sufficient” for all urine collections that are calculated as QNS by the scale application. The laboratory technician may also assign this comment code to all samples that are changed to QNS during the verification process.

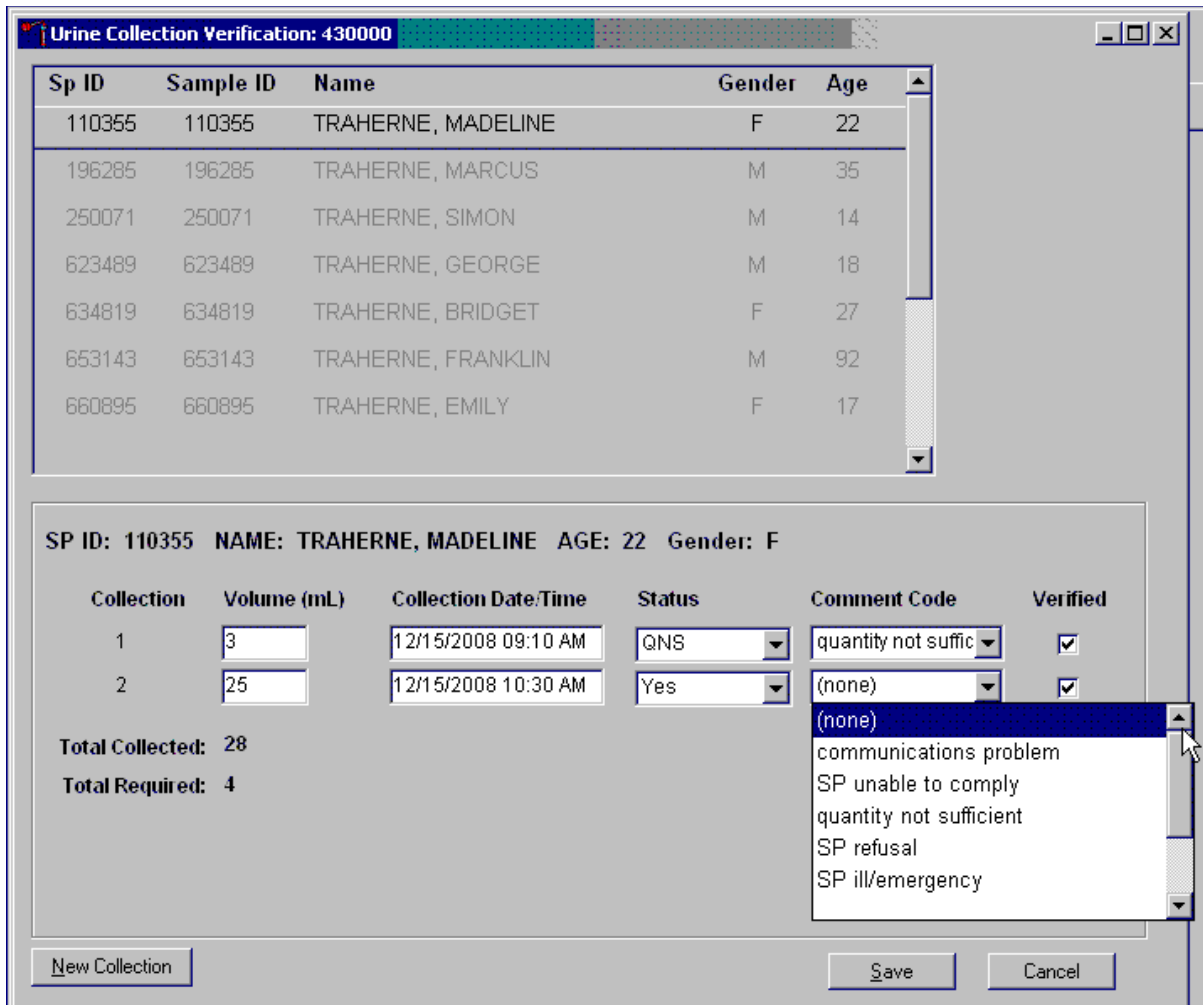

To record a comment, direct the mouse arrow to the drop-down list, click to display the comment codes, and select the most appropriate choice. Alternatively, use the up and down keyboard arrows to scroll through the choices or type the first letter of the desired comment code and, when the correct choice is highlighted, left-click.

Verify the results of the urine collection.

Sp ID	Sample ID	Name	Gender	Age
110355	110355	TRAHERNE, MADELINE	F	22
196285	196285	TRAHERNE, MARCUS	M	35
250071	250071	TRAHERNE, SIMON	M	14
623489	623489	TRAHERNE, GEORGE	M	18
634819	634819	TRAHERNE, BRIDGET	F	27
653143	653143	TRAHERNE, FRANKLIN	M	92
660895	660895	TRAHERNE, EMILY	F	17

SP ID: 110355 NAME: TRAHERNE, MADELINE AGE: 22 Gender: F

Collection	Volume (mL)	Collection Date/Time	Status	Comment Code	Verified
1	3	12/15/2008 09:10 AM	QNS	quantity not suffic	<input checked="" type="checkbox"/>
2	25	12/15/2008 10:30 AM	Yes	(none)	<input checked="" type="checkbox"/>

Total Collected: 28
Total Required: 4

Buttons:

To verify, direct the mouse arrow to the “Verify” check box. Left-click on the check box and a checkmark will appear in the box. Verifying the results will save the results to the database.

To save a result to the database without exiting the module or removing the window, direct the mouse arrow to the “Verify” check box. Left-click on the check box. Alternately, direct the mouse arrow to the “Save” button and left-click or press [Enter] when it is highlighted. To save a result to the database and exit the module and remove the window, direct the mouse arrow to the “OK” button and left click. To exit the module and remove the window without saving any information to the database, direct the mouse arrow to the “Cancel” button and left-click. To exit the module or close the window after saving results to the database, and without recording any further actions, direct the mouse arrow to the Close Window button and left-click.

11.4.3 Urine Processing

Use the urine processing labels printed in advance to label the SP's urine vessels. The urine processing protocol is displayed in Exhibit 11-3. Dry run volunteers are eligible for at least one vessel – 45. There are two sets of labels for each dry run volunteer. Label one set of vessels with the first set of labels (SP ID) and the second set with the second set of labels (Sample ID).

Exhibit 11-3. Dry run urine processing protocol

ID	Assay	Sample size ml	Vessel
45	Alb/Creat	3	5-ml cryovial

Procedures for Dry Run Volunteers

- Label one 5-ml cryovial for the first test – #45. Label one tube with the volunteer's original SP ID. Label the other tube with the volunteer's Sample ID.
- Aliquot 3-ml of urine into each of the two #45 vessels using a large plastic transfer pipette.
- Enter the results of urine processing for the original SP ID and again for the Sample ID.

After filling the urine specimen vessels for each dry run volunteer, use the Urine Processing module to enter the urine processing status results.

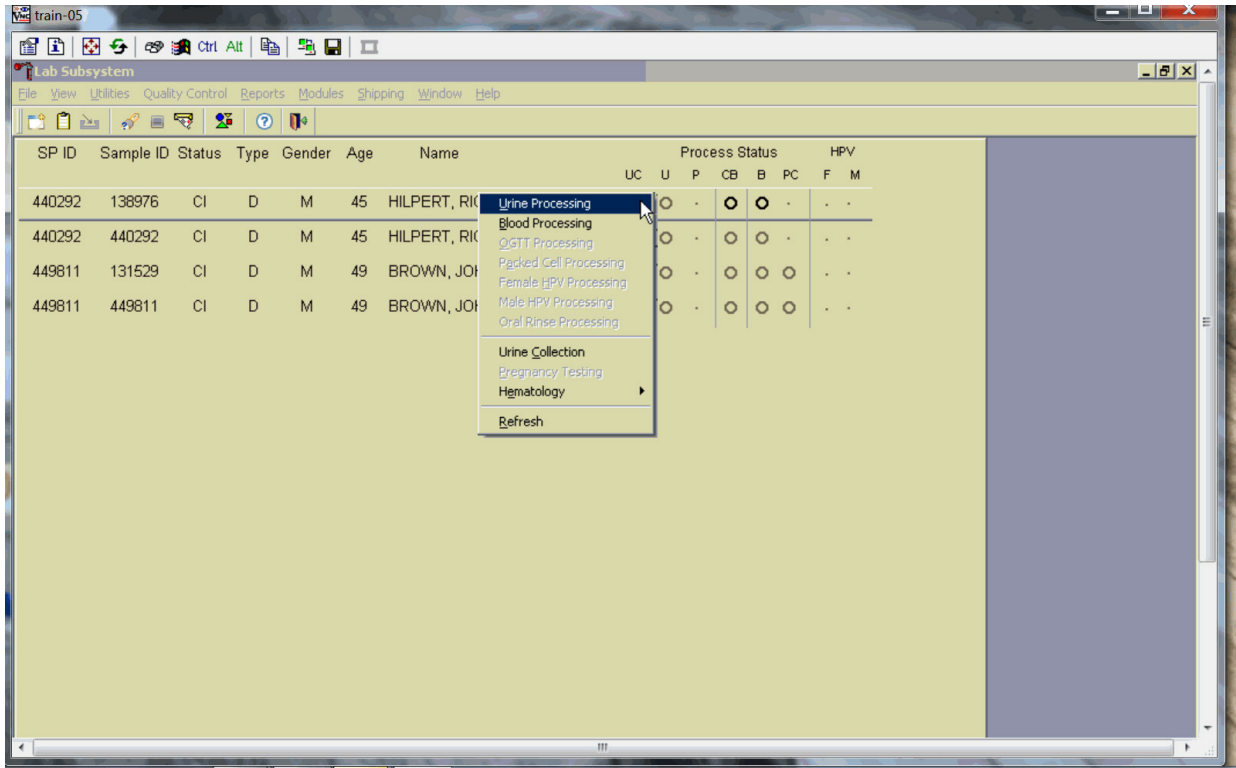

To access the Urine Processing module, direct the mouse arrow to the correct volunteer, right-click, drag the mouse arrow to {Urine Processing}, and right-click.

The volunteer’s urine processing screen displays.

UR: 119114
U processing

Tech ID: 1700 Sample ID: 119114 Name: RAMOS, STEPHEN Gender: M Age: 72
 SP ID: 119114 Appt Type: Dry Run Fasting Req: Morning - Fast

Vessel ID	Test Name	Sample Volume	Vessel Type	Vessel Volume	Vessel Name	Filled	Comments	Container ID	Slot#
45	Albi/Creat	3.0	U	5 ml	Nalge Cryovial	<input checked="" type="radio"/> Yes <input type="radio"/> No	(none)		

Save OK Cancel

To mark an individual urine vessel as collected or Filled – Yes, direct the mouse arrow to the “Yes” radio button and left-click. As each vessel is marked as Filled – Yes, it is automatically assigned to a slot in an existing (open) container. To mark an individual urine vessel as not collected or Filled – No, use the mouse to direct the mouse arrow to the “No” radio button and left-click. As each vessel is marked as Filled – No, the comment, “quantity not sufficient” is automatically entered in the Comments column. To collectively mark all vessels as Filled – Yes, use the mouse to direct the mouse arrow to the Filled button above the radio buttons, left-click, and drag the arrow to {Fill All} and left-click. To mark all vessels as Filled – No, direct the mouse arrow to the “Filled” button above the radio buttons, left-click, drag the mouse arrow to {Not Filled All}, and left-click.

Use the quality comment code to indicate if blood is present. Store each filled vessel in the assigned slot in the assigned container. To record this action or to save the data to the database, direct the mouse arrow to the Save button, and left-click. To record this action or to save the data to the database and exit the module, use the mouse to direct the mouse arrow to the “OK” button and left-click. To close the window without saving any data in the database, direct the mouse arrow to the Cancel button, and left-click.

Access the Sample ID record on the heads-up display and record the processing results.

UR: 491426
U processing

Tech ID: 1126 Sample ID: 491426 Name: RAMOS, STEPHEN Gender: M Age: 72
 SP ID: 119114 Appt Type: Dry Run Fasting Req: Morning - Fast

Vessel ID	Test Name	Sample Volume	Type	Vessel Volume	Vessel Name	Filled	Comments	Container ID	Slot#
45	Alb/Creat	3.0	U	5 ml	Nalge Cryovial	<input checked="" type="radio"/> Yes <input type="radio"/> No	(none)	0415789	4

UR: 119114
U processing

Tech ID: 1126 Sample ID: 119114 Name: RAMOS, STEPHEN Gender: M Age: 72
 SP ID: 119114 Appt Type: Dry Run Fasting Req: Morning - Fast

Vessel ID	Test Name	Sample Volume	Type	Vessel Volume	Vessel Name	Filled	Comments	Container ID	Slot#
45	Alb/Creat	3.0	U	5 ml	Nalge Cryovial	<input checked="" type="radio"/> Yes <input type="radio"/> No	(none)	0415789	3

Save OK Cancel

Remember to process vessels in pairs and, if the quantity of urine is insufficient to fill both vessels, do not record either vessel as filled. Place a yellow cryodot on each vessel filled during the Dry Run to insure these samples are not shipped to the CDC biorepository by the labs after testing. Store the vessels in a manner identical to vessels processed during a regular session.

Discard any remaining urine specimen at the end of each session. Pour urine down the drain in the laboratory sink. Flush the sink with water. Discard urine cup in the trash.

The urine-processing technologist performs the pregnancy test on female dry run volunteers aged 8-59 years and documents the results following the procedures described in Chapter 5.

11.4.4 Hematology

The technologist at workstation 3 runs two CBCs, in duplicate, for each dry run volunteer after the blood processing technologist processes whole blood from the 4-ml EDTA tubes according to the whole blood processing protocol (see Exhibit 13-4). Run the first CBC in duplicate on the first 4-ml EDTA tube with the original SP ID on the tube. Evaluate results, and save the data using procedures described in Chapter 7.

Exhibit 11-4. Dry run processing protocol—whole blood

ID	Test name	Groups	Sample (mL)	Sample type	Collection type	Vessel type
1	Lead/Cad/HG/Se/Mn	Both	0.4	Whole blood	4-ml EDTA	2-ml
3	RBC Folate	Even	0.1	Whole blood	4-ml EDTA	2-ml
4	Glycohem	Odd	0.4	Whole blood	4-ml EDTA	2-ml
5	Mercury	Even	0.5	Whole Blood	4-ml EDTA	2-ml
88	Acrylamide	Odd	1.0	Packed cells	4-ml EDTA	2-ml

Run the second CBC in duplicate on the second 4-ml EDTA tube using the Sample ID. Evaluate results and save the data using procedures described in Chapter 7. For SPs whose SP ID ends in an odd digit, share the lavender tube with the blood processing workstation.

11.4.5 Blood Processing and Storage

Print blood-processing labels using procedures described in Chapter 8. There are two sets of labels for each dry run volunteer; one set of labels contains the SP ID and the second set contains the Sample ID. Prepare two blood processing racks (one with the SP ID labels and one with the Sample ID labels) using the blood-processing template for ages 12+.

Treat each set of venipuncture tubes and pre-labeled blood processing racks as two independent and separate dry run volunteers. Process the complete first set of venipuncture tubes and blood processing vessels on the dry run volunteer using the original SP ID, and then process the second set of venipuncture tubes and blood processing vessels using the Sample ID.

For volunteers whose SP ID and Sample ID ends in an odd digit, process one of the 4-ml EDTA tubes for Lead/Cad/HG/Se/Mn, Glycohem, and Acrylamide . For volunteers whose SP ID and Sample ID ends in an even digit, process one of the 4-ml EDTA tubes for Lead/Cad/HG/Se/Mn,

RBC Folate, and Mercury. Use processing procedures described in Chapter 7. Match the EDTA tube with the SP ID to the corresponding blood processing rack. Match the second EDTA tube with the Sample ID to the corresponding blood processing rack.

When the SP ID ends in an even or an odd digit, process each of the 2-ml gray-top tubes for glucose using the same procedures described in Chapter 7.

Process pooled serum for the dry run volunteers using the dry run blood processing protocol – serum (Exhibit 11-5).

Exhibit 11-5. Dry run blood processing protocol—serum

ID	Test name	Groups	Sample (mL)	Sample type	Collection type	Vessel type
110	Folate1	Odd	0.7	Serum	15-ml Red	2-ml
99	Ferritin	Odd	0.4	Serum	15- ml Red	2-ml
70	Vitamin D	Odd	0.9	Serum	15-ml Red	2-ml
79	Vitamin C	Odd	0.1	Serum	15-ml Red	2-ml
122	HAV	Even	1.0	Serum	15-ml Red	2-ml
17	Cotinine	Even	1.8	Serum	15-ml Red	2-ml
21	Lipids	Both	1.0	Serum	15-ml Red	2-ml
11	Iron/TIBC/% saturation	Even	0.5	Serum	15-ml Red	2-ml
18	Biochem	Both	0.5	Serum	15-ml Red	2-ml
23	Insulin	Odd	1.0	Serum	15-ml Red	2-ml
13	CRP	Even	0.3	Serum	15-ml Red	2-ml

- Fill each vessel as described in the blood processing protocol.
- Process the complete first set of venipuncture tubes and blood processing vessels on the dry run volunteer using the original SP ID. Continue to use the labeled vessels in the prepared rack.
- Process the second set of venipuncture tubes and blood processing vessels using the Sample ID. Continue to use the labeled vessels in the prepared rack.
- Use the same techniques for spinning and separating the blood as described in Chapter 7.
- Check the labels before filling the vessel, making sure that each vessel has the correct SP ID or Sample ID.

Match the two processing racks to each other. Record the blood processing results.

B processing

Tech ID: 1756	Sample ID: 503985	Name: DR6, SP6	Gender: M	Age: 19
SP ID: 503985		Appt Type: Dry Run	Fasting Req: Morning - Fast	

Vessel ID	Test Name	CAP	Sample Volume	Type	Vessel Volume	Vessel Name	Filled	Comments	Container ID	Slot#
1	PbCadHgSeMn		0.4	W	2 ml	Nalge Cryovial	<input type="radio"/> Yes <input type="radio"/> No			
4	Glycohem		0.4	W	2 ml	Nalge Cryovial	<input type="radio"/> Yes <input type="radio"/> No			
9	Glucose		0.5	P	2 ml	Nalge Cryovial	<input type="radio"/> Yes <input type="radio"/> No			
136	Se/Cu/Zn		1.0	S	2 ml	Nalge Cryovial	<input type="radio"/> Yes <input type="radio"/> No			
70	Vit D/FA	●	0.7	S	2 ml	Nalge Cryovial	<input type="radio"/> Yes <input type="radio"/> No			
21	Lipids	●	1.5	S	2 ml	Nalge Cryovial	<input type="radio"/> Yes <input type="radio"/> No			
18	Biochem		0.8	S	2 ml	Nalge Cryovial	<input type="radio"/> Yes <input type="radio"/> No			
23	Insulin		1.0	S	2 ml	Nalge Cryovial	<input type="radio"/> Yes <input type="radio"/> No			
118	Thyroid		1.0	S	2 ml	Nalge Cryovial	<input type="radio"/> Yes <input type="radio"/> No			
127	IgA-TTG/EMA		0.5	S	2 ml	Nalge Cryovial	<input type="radio"/> Yes <input type="radio"/> No			
137	TST		0.5	S	2 ml	Nalge Cryovial	<input type="radio"/> Yes <input type="radio"/> No			
110	Folate 1		0.7	S	2 ml	Nalge Cryovial	<input type="radio"/> Yes <input type="radio"/> No			

B processing

Tech ID: 1756	Sample ID: 103733	Name: DR6, SP6	Gender: M	Age:
SP ID: 503985		Appt Type: Dry Run	Fasting Req: Morning -	

Vessel ID	Test Name	CAP	Sample Volume	Type	Vessel Volume	Vessel Name	Filled	Comments	Container ID	Slot#
1	PbCadHgSeMn		0.4	W	2 ml	Nalge Cryovial	<input type="radio"/> Yes <input type="radio"/> No			
4	Glycohem		0.4	W	2 ml	Nalge Cryovial	<input type="radio"/> Yes <input type="radio"/> No			
9	Glucose		0.5	P	2 ml	Nalge Cryovial	<input type="radio"/> Yes <input type="radio"/> No			
136	Se/Cu/Zn		1.0	S	2 ml	Nalge Cryovial	<input type="radio"/> Yes <input type="radio"/> No			
70	Vit D/FA	●	0.7	S	2 ml	Nalge Cryovial	<input type="radio"/> Yes <input type="radio"/> No			
21	Lipids	●	1.5	S	2 ml	Nalge Cryovial	<input type="radio"/> Yes <input type="radio"/> No			
18	Biochem		0.8	S	2 ml	Nalge Cryovial	<input type="radio"/> Yes <input type="radio"/> No			

Enter results for the vessels where both vessels are filled for the whole blood, plasma, and serum protocol. Enter the results of blood processing using the correct Sample ID and SP ID numbers and procedures described in Chapter 8, Section 8.8. Place a yellow cryodot on each vessel filled during the Dry Run to ensure these samples are not shipped to the CDC biorepository by the labs after testing. Store the blood vessels in a manner identical to blood vessels processed during a regular session.

11.4.6 Shipping Dry Run Specimens

Ship the split sample blood and urine vessels with samples from the regular sessions following procedures described in Chapter 8.

11.4.7 Workstation Job Aids

Station 3 Quick Reference

Daily:

- Get 6C QC and urine hCG QC out of fridge
- Log into coulter, Place online
- In ISIS, Double click on Coulter, Scale, and Lab icons on desktop. Make sure Coulter and scale icons now show on lower right
- Sign in to ISIS – mecuser, Westat1, lab = last name_ 1st initial, your street # is password
- Place blotter sheet as desired
- Make Ascorbic Acid using DI water under sink and the 50 and 10 mL cylinders over sink
Powdered AA is premeasured in conical tube and a small vial in cabinet over sink
Measure 30 mL DI water and pour into large conical tube. Cap and mix
Measure 2 mL DI water and pour into small vial. Cap and mix
Write date and initial on both vials
Cover vials with Aluminum foil, place on Station 2 rocker to mix

Coulter Start Up

- Check that daily checks passed. If anything failed, repeat daily check once, if still failed, troubleshoot, repeat shut down cycle. If DC still fails, call hotline and troubleshoot. Do not run Latron or QC until Daily checks has passed.
- Log any troubleshooting into DXH and on Troubleshooting log, and on Coulter.
- Run latron, then 6C QC, making sure all passes. Click into each level to accept or not; add comments to show action for anything that did not pass. Exclude any out of range control. Delete only a QNS control. Remix and rerun any failed QC, then troubleshoot if it still fails.
- Initial Daily Checks printout, then place in Coulter Log book under “Start Up” in cabinet to left of Coulter
- Click “menu” then “patients” before running SPs

CBC

- Each CBC sample is automatically run twice in DxH
- Children younger than 3 will only have 1 purple top drawn, so processing takes their aliquots out then gives tube to Coulter. Check volume. But, CBC takes precedence over processing if the volume may be QNS. Fill as many WB vials as possible in priority order making sure there is at least 1 ml left to run CBC.
- Results cross into ISIS. Click on “modules” then “hematology” then “retrieve.”
- Click on SP number, Both runs will be highlighted. Scan results for imprecision, flags, voteouts, high/low or critical values. Click Average.
- If there is a critical WBC, HGB, or Platelet, send an Observation in ISIS to physician stating SP ID, parameter and critical results, tech initials, date and time notified.
- If precision error pops up, check box that control was run, run 1 control, then run sample a third time. Retrieve again, delete the run/runs that do not match and click on “average” again. Click OK that you do indeed want a new average. Never average more than two runs.
- Review the control to ensure it is in range then make a comment that the control was run due to imprecision.error.

To pop up question asking if controls were run and were they in range. Young children may only be able to be run once. Still click “average” and say OK to the message that it is only one run

- If one run has a flag and the other does not, run a third time. Average the two similar results (either both runs must have the same flag, or neither have a flag)
- Tubes are good for 24 hours at RT if Coulter goes down.
- If CBC analysis does not occur due to high room temperature, then bag purple tops in biohazard bag and store in a cool place (generally cabinet in physician room) until lab temperatures are again in acceptable range.
- Discard tubes in red large biohazard container at end of session.

HCG

- Run pos and neg urine controls. Set 3 minutes on timer to read.
- Run serum controls only if doing a serum HCG.
- Record QC in ISIS under Quality Control, Pregnancy Controls, checking lot # of Controls and kit when entering.
- When changing control lot numbers, go into QC, Pregnancy Controls, “ADD” on lower left. Add new lot number.
- If it is a new kit Lot #, cut the corner off the box showing the lot# and place in the slot of the plastic tray holding the test cassettes.
- Do HCG asap, even if urine is QNS. Can’t do DXA until HCG is recorded.

SCALE

SET UP

- Remove cone protector, place in hard case
- Place disc on scale, setting the bar into the notch on the underside
- Level by turning legs – check level bubble
- Unclip cords: plug in scale cords
- Weigh start up weights in weight case (100 grams and 2-300 grams for 600)

DAILY

- Turn on scale on front power button. This also tares it, so replace cover while it is taring.
- Use the flannel cloth, white glove, or tweezers to place weights on the scale. Record reading of 20 and 500 gram weights in ISIS under Daily QC.
- Coordinator starts giving SP water as soon as QNS is recorded so weigh urines ASAP even if you don’t verify right away.

Daily QC

- Record all daily QC in ISIS under QC, Daily.
- Workstation 2 room temp and humidity is from digital thermometer on counter to the right of #2 centrifuge, Workstation 3 RT is from digital thermometer on the right side of Coulter. Record centrifuge refrigerated temps from readout on centrifuges after they have been turned on and run. Hood Magnetron readout from dial.
- Once a “Done” is checked and screen is closed it cannot be edited. Edits and edits can be made by reopening screen if the “Done” box has not been checked, but all boxes must be checked to save Daily QC. Make any subsequent corrections using a UFO.

SP URINES

Place on scale with cover on urine container and clear cover on scale. Scan urine barcode. Weight of urine = Scale weight – Weight of container. ISIS subtracts the weight of container, so if you have to enter weight manually, subtract 48 for 6 and up, 64 for 3-5 YO container. ISIS will indicate QNS by showing blue circle with blue dot. Coordinator sees this even before it is verified, so they know to start giving SP water to drink. ISIS then adds a line for a second collection. If a 12 and up SP collects urine in a 3- 5 YO container, manually enter weight and subtract a tare of 64.

- Perform HCG on the QNS sample if applicable. Weigh and verify 2nd and 3rd sample if necessary. Aliquot only after pooling QNS and 2nd (or even 3rd) samples.
- There is a drop down box for comments such as bloody or turbid. Note these in drop down comment. Still aliquot the bloody or turbid urines and also comment in the urine processing field.
 - Aliquotting – After HCG and weight are completed, label vials with the preprinted labels. See required vials and volumes by right clicking mouse on SP name, left click on Urine processing. The tests, vials, volume and slots are shown. There are 5 size/shapes of vials used.
- Some SP's may opt out of the extra vessels 32-34. Discard these labels, tell Tech at Station 2 which SP opted out of extras, (or discard serum vessel extras yourself).
- MERCURY # 62 must be exactly 5 ml of urine. Tubes have preservative label to indicate mercury tube. Use small transfer pipette to measure urine for HG⁺⁺. For example, pipet 3 + 2 ml, or 2.5 + 2.5 for a total of 5.
- Phthalates must be filled with transfer pipet to exactly 4.5 ml.
- Leave room for expansion after freezing.
- Click Filled, then Fill All; slot is indicated. Place all vials in correct box/slot, then click "OK". IF QNS for some tubes, check "NO" box under filled, then pick QNS comment from drop down menu. "OK" to save and close.
- After box mapping and ensuring all urine tests are completed and aliquotted, black out SP name on urine container, discard urine in sink and dispose of containers in regular trash.

HPV Swab

Take female swab out of plastic bag. Highlight SP name, left click for HPV swab, verify. You can box map these as you receive them. Place swab in hanging plastic bag. Check male HPV vial to ensure there is liquid. If not, do not process. Notify coordinator that male swab must be recollected due to no fluid being in vial.

VOC:

- Place on CBC rocker.
- Ensure all powder on bottom of tube is dissolved.
- Check that tube has 2nd specific VOC barcode label on tube.
- Right click on SP name, blood processing, click on radio button "Yes" under filled beside VOC. DO NOT click "OK", click the "SAVE" button on lower left, then cancel or "X".

End of Session

Log out by closing "X" on upper right of LAB screen.

END of DAY

- Box map, clean counter, scale, mouse and scanners, log out of coulter, reboot computer.
- DxH is set to automatically shutdown and clean at 7 AM every morning.

Weekly :

- ISIS will indicate the day weekly QC is done. This is determined by the day set up was recorded in ISIS.
- Transmit Coulter QC. L-J Icon, "Select Control", highlight one 6C or Iatron control, OK, Transmit button. Choose "All runs in Current Control File, OK. Must go in and highlight then transmit each control separately, but can do it back to back without waiting for each to transmit separately.

Last session before "Weekend"

Fill sink with 10% bleach by using eyewash hose and pouring bleach in. Wash all trays, plastic racks, holders, lids, flipper rack for urines, rubber rocker pads. Place all on absorbent paper between Coulter and Hood. Can reuse paper weekly. Clean centrifuge cups and inserts with 10% Beckman Cleaning Solution.

Perform weekly maintenance on DxH and initial maintenance records on clipboard in front of keyboard.

Running CAP Proficiency Samples

To make barcode labels:

Utility on desktop

- "Dymo test labels"
- Highlight the label shown
 - Click on "Properties" in far upper right
 - Symbology – choose "Code 128 Auto" this should be only thing to change but check following:
 - Data: Barcode delete "Click ME" or "0000001" and type in proficiency sample number i.e. FH6-01
 - Align: Center
 - Size: Medium
 - Show Barcode Text: Below
 - OK
- Double click on "Click Me"
- Under Data: Barcode Data, delete "Click ME" and type in proficiency sample number ie FH601
- OK
- Print – will print on Dymo label maker
- Repeat for all 5 samples
- Exit out
- "No" to "Do you want to save?"

To auto print results for Proficiency samples:

First look to ensure that “Disable all auto printed reports” box is UNCHECKED in Menu> Setup> System> Printers> Printer set up. It should always be unchecked.

- Then: Menu> Reporting> Auto report
- ✓ box “Print Lab Report as Each Analysis is Complete”
- OK
- BE SURE to uncheck box “Print Lab Report as Each Analysis is Complete” after you have finished running and printing the samples

Run Proficiency samples in cassette (will be run twice under current set up and each result will print separately)

Average results on “Heme CAP spreadsheet.xlsx”

Save as KitName-KitNumber_YYYY-MMDD_MEC#_TechInitials_S (for secondary) or P (primary)

If Primary operator: Enter results on CAP paperwork>Enter results in CAP site on computer – use personal log in created for CAP>Have another tech proof your computer entry before final Send> Print CAP computer site results for your record

Keep a copy of the worksheet (and CAP Computer worksheet if primary). Record on your Annual CAP Survey Check Sheet. Indicate if primary or secondary operator.

Don’t finish or verify other tech’s work without their permission even when they are on break. Make sure you are signed in under your name when in ISIS.

Work Schedule for shipping:

Station 1 – Work AM in Hematology, Help wrap containers, close, assign manifests, do the outside shipping. Off the evening session

Station 2 – Work usual times both shifts.

Station 3 – Off until 12:15 PM. Help finish wrapping containers, do inside shipping. Stay till Fed Ex has picked up packages, call Fed Ex if they don’t show by stated time. Leave then come back and work in Heme at 5:30.

11.5 Centrifuges Allegra X-15R—Equipment Maintenance

Technologists are responsible for inspecting the centrifuges at the beginning of each stand, and inspecting and cleaning the centrifuges at the end of each stand and whenever necessary. Clean the interior of the chamber with a mild soap, as time permits. Rinse thoroughly and dry completely.

Centrifuge Cleaning

Clean the centrifuge as needed and at the end of each stand. Always clean up spills when they occur to prevent corrosives or contaminants from drying on component surfaces.

- To prevent accumulations of sample dust, and/or glass particles from broken sample tubes, keep the chamber clean and dry by frequent wiping with a cloth or paper towel.
- For thorough cleaning, wash the chamber using a mild detergent such as a 1:10 dilution of Beckman Solution 555.
- Rinse thoroughly and dry completely.
- Clean the centrifuge exterior surfaces by wiping with a cloth dampened with a 1:10 dilution of Beckman Solution 555.
- Remove the rotor from the centrifuge and clean the drive hub regularly using a 1:10 dilution of Beckman Solution 555 and a soft brush.

Rotor Care and Maintenance

NOTE: Do not use sharp tools on the rotor that could cause scratches in the rotor surface.

Corrosion begins in scratches and may open fissures in the rotor with continued use.

- At the start of stand, inspect the rotor yoke and buckets, especially inside cavities, for rough spots or pitting, white powder deposits—frequently aluminum oxide—or heavy discoloration.
- If any of these signs are evident, do not run the rotor.
- Contact your Beckman Coulter representative for information about the Field Rotor Inspection Program and the rotor repair center.

- At the start of stand and after cleaning, wipe the rotor pins and pin sockets with a paper towel, and then coat the sockets with Paint-On Graphite lubricant (Exhibit 11-6).
- Allow the lubricant to dry for at least 5 minutes before installing the rotor in a centrifuge.

Store the rotor inside of the foam-lined bin, at the end of stand. Place the white, cross-shaped hard foam piece onto the rotor spindle after removing the rotor. The hard foam should remain in place until the start of the next stand.

Exhibit 11-6. Lubrication points

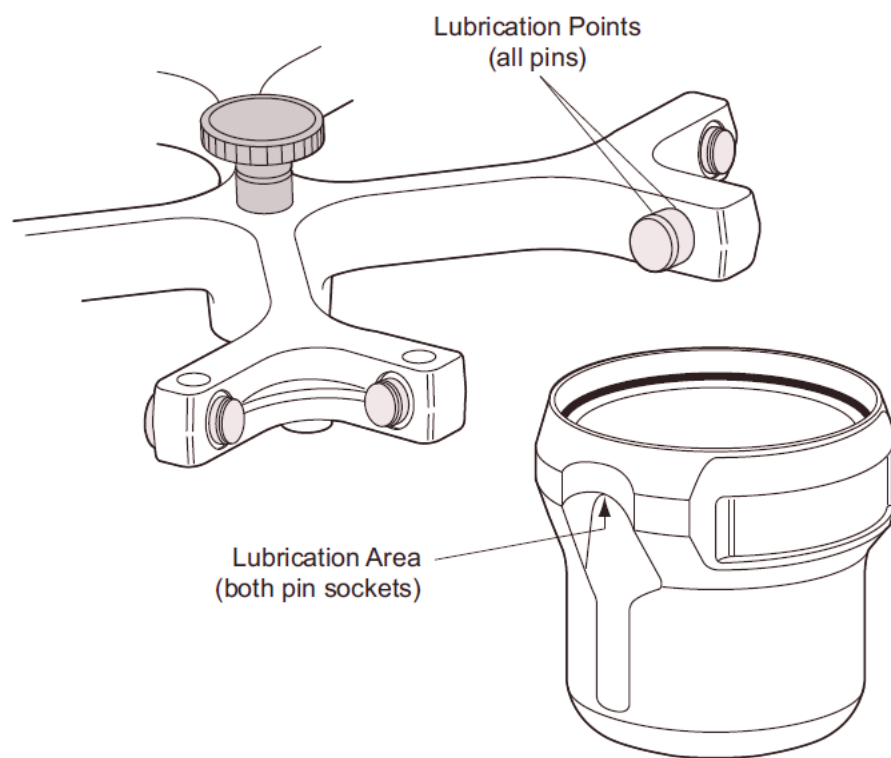

Cleaning the Rotor

NOTE: Do not wash the rotor components or accessories in a dishwasher. Do not soak components in detergent solution for long periods, such as overnight.

- If spillage has occurred, or if salt solutions or other corrosive materials are used, clean the rotor and components immediately and at the end of each stand.
- Do not allow corrosive materials to dry on rotor components.

- After cleaning or at the start of each stand, clean the pins and bucket pin sockets and then lubricate as described under Rotor Care and Maintenance.
- At the end of stand, remove the rotor from the centrifuge for cleaning and lubrication to prevent buildup of residues.
- Use a 1:10 dilution of Beckman Solution 555 and a soft brush to clean the rotor yoke and tie-down knob.

Before reinstalling the rotor, lightly lubricate the drive hole of the rotor (middle hole in the center of the underside) with Anti-Seize (Spinkote) to prevent the rotor from sticking, as follows:

- Apply the lubricant onto a swab.
- Draw the coated swab through a paper towel to remove excess lubricant.
- Lightly coat the inside of the drive hole with the lubricant remaining on the swab.

Care and Maintenance for Buckets

- Clean the buckets, at the end of each stand, with a 1:10 dilution of Beckman Solution 555, and then rinse thoroughly and dry completely.
- After cleaning the buckets, lubricate bucket pin sockets with Paint-On Graphite Lubricant as described under Rotor Care and Maintenance.

Care and Maintenance for the Aerosolve Canisters

- Remove the O-ring from the canister before cleaning.
- Clean the canister and O-ring, at the end of each stand, with a 1:10 dilution of Beckman Solution 555, then rinse thoroughly and dry completely.
- Coat the O-ring with a light film of silicone vacuum grease.
- Place the O-ring on the ledge inside the canister.

Items needed for care and maintenance of the buckets and canisters of the Allegra X-15R include the Vacuum Grease Silicone, Paint-On Graphite, and Spinkote lubricant.



The NCHS biomedical engineer certifies both centrifuges annually. The NCHS engineer determines the rpm of the instruments using a strobe light or a tachometer. The engineer records multiple readings for each centrifuge. The Beckman Coulter Allegra X-15R centrifuge should exceed 3,750 rpm to ensure adequate centrifugal force development. The engineer checks each centrifuge timer against a stopwatch and records the values in the Laboratory QC module—NCHS QC.

Document beginning and end of stand cleaning procedures in the Laboratory QC module.

11.6 Refrigerators and Freezers—Equipment Maintenance

The freezers require proper ventilation in order to operate efficiently, and the air around the freezers must be free to circulate.. Do not store anything between the freezers or between rack supports and the freezer. Do not store anything on the top grill.

Quality Control (QC) procedures for the refrigerators and freezers include cleaning them at the beginning and end of the stand and whenever necessary. Continuously monitor the temperatures of refrigerators and freezers on a daily basis, using the TempGuard system, which automatically captures and graphs the refrigerator and freezer temperatures, and is available in real time.

11.7 Use of the Temperature Recording Instrument

The TempGuard system is a multiple device monitor and alarm system that is equipped with an integrated autodialer and data logging capabilities. The TempGuard system automatically monitors the interior temperature of the refrigerators, freezers, and room temperature.

The system can monitor up to eight temperature sensors and each sensor must have a probe submerged into a bottle of resin.

The TempGuard system has been programmed with the following: upper and lower limits for all units including the room temperature and a 60-second delay for the allowable time the freezer door can be left open before the system will alarm. The system has the capability to send out calls and emails to alert staff to temperature issues.

Checking TempGuard Sensors

All temperature sensors connected will have their temperature readings displayed next to the sensor number on the display.

Disabling Alarm

1. Push the black button on the left side of the TempGuard for MEC 1 and 3 to see any alarm conditions. For MEC 2, the black button is on the top of the TempGuard unit.
2. Hold the button for 5 seconds to confirm the alarm condition.
3. Alarm conditions must be confirmed individually.
4. The alarm relay will de-energize, and the TempGuard will stop making callouts for the current alarm condition.

Start of Stand Setup (performed by the Facilities Equipment Specialist)

Programming the Autodialer Functions:

(The MEC manager phone number needs to be updated at each stand.)

1. Enter the “Full Access” PIN (Enter **0000**).
2. From the Program Menu, Select **1** to set telephone numbers.

3. You will hear “**Select contact.**”
4. Select **1** for the first contact number (FES phone #).
 - Enter your phone number, using this format “**1 + area code + 7 digit #**”
5. You will hear “Contact 1 is xxxxxxx” or “Contact x is Empty, press one to change.”
6. Press 1 to make a change or enter a telephone number.
7. You will hear “Enter number, then press pound.”
8. Enter the number, followed by the # key.
 - Entering the # key will erase the currently programmed contact telephone number.
9. You will hear the telephone number you just entered.
10. You will be prompted to select another contact to program.
11. Select 2 for the second contact number (MEC manager’s number).
 - For Balde, enter **1-240-205-0193**
 - For Mary, enter **1-240-620-2313**
12. Press **0** to return to the Program Menu.

The acceptable temperature range for refrigerators used for storage of Clinical Laboratory Improvement Amendments (CLIA)-regulated specimens and reagents is 2–8°C and is checked and recorded daily.

Freezer temperatures are monitored daily by visual inspection of either a thermometer or graphs and recorded. All freezers are monitored automatically by built-in visual systems (with thermographic or digital reading), which is determined by the probe in the antifreeze solution. The range of allowable temperature for the -30 Revco model is -26 to -34°C. If the range is exceeded, the technologist contacts the MEC manager.

Digital thermometer verification process

1. Check the NIST traceable thermometers to ensure the expiration date has not been exceeded. If the thermometer’s certificate is expired, contact the warehouse to have a new thermometer delivered.

2. Place the appropriate thermometer in the refrigerator, freezer, or next to the room temperature digital thermometer. The same thermometer can be used for the refrigerators and room temperature checks.
3. Allow the thermometer to remain in the environment for 2 hours to equilibrate. Avoid opening and closing the refrigerator and freezer doors during this time.
4. After 2 hours, record the temperature from the traceable thermometer and the digital thermometer on the Laboratory NIST Temperature Check Sheet.
5. Calculate the difference between the two temperatures.
6. If the temperatures differ (+/-) by more than 2°C, contact the FES to have the digital temperature reading adjusted to be within the 2°C limits.
7. After the adjustment is completed, repeat the process and record the temperature on a new Laboratory NIST Temperature Check Sheet.

Repeat this process until all refrigerator, freezer, and room temperature digital readings are within 2°C of the traceable thermometers.

11.8 Use of the Class II Type A Biological Safety Cabinet

The Labgard Model NU-425 Class II, Type A2, Laminar Flow Biological Safety Cabinet (LFBSC), with proper technique, provides an effective partial containment system for safe manipulation of moderate- and high-risk microorganisms (see Exhibit 13-7). The vertical laminar airflow barrier prevents contaminated air from entering or escaping from the open-front work chamber, protecting the cabinet contents and the technologist. A high-efficiency filter system decontaminates both the incoming air and the exhaust.

Installation, Certification, and Maintenance

The NCHS biomedical engineer arranges for a certified engineer to perform the required annual certification that includes replacement of High Efficiency Particulate Air (HEPA) filters as necessary.

The basic concept of the LFBSC is to take air through a blower system, pressurize a plenum, and force air through a filter. Built-in supply and exhaust blowers come with separate HEPA filters. The

recirculating airflow pattern directs a portion of the HEPA filtered air straight down over the central work area driving the airborne contaminants into the surrounding grills, allowing a pollution-free environment for particular specifications. If a filter is defective, the filtration system no longer filters and becomes a vacuum cleaner, taking in gross contamination and exploding it through the defective filter onto and around the critical work area. The filter of the LFBSC is a permanent part of the disposable plenum. A manometric gauge is calibrated in “inches of water gauge” pressure (w.g.). The gauge indicates when the supply HEPA filter is clogged. As the filter loads with particulate matter, the amount of pressure registered on the gauge will increase. The initial pressure reading is approximately 0.4 w.g. \pm 0.05 w.g. depending on the altitude from sea level.

Clean the LFBSC at the beginning and end of each stand. Lift the front glass and wash both the interior and exterior glass with Windex. Remove all contents from the interior of the cabinet. Remove and wash the front grill with Sani-Cloth Plus cloths or Bleach-Rite. Lift the cover to the table and wash the base underneath. Put table cover and grill back into cabinet. Wash the bottom outside floor and legs of the hood where splashes from the biohazard container may have contaminated the surface. Lock front glass into place. Document these activities in the Laboratory QC module. Take and record the pressure reading in the Laboratory QC module at the beginning of stand and at the start of each session.

Document all unscheduled maintenance for the LFBSC in the automated Unusual Field Occurrence utility.

Exhibit 11-7. Operating the laminar flow biological safety cabinet**Operating the NU-425, Laminar Flow Biological Safety Cabinet*****1.1 Operator Controls and Indicators**

The following is a description of the controls and indicators found on both the front panel (see Drawing BCD-05322) and cabinet.

1.1.1 Circuit Breaker-Blower (Top of Control Center)

The motor/blower is protected with a circuit breaker. The circuit breaker in conjunction with the motor's thermal protector is designed to open under locked rotor or half-wave power conditions. Should the circuit breaker open (pop-out button will appear), merely depress to reset. If the circuit breaker continually opens, a failure has occurred in the motor or solid-state speed controller. Consult a qualified repair technician or NuAire, Inc. for replacement.

1.1.2 Circuit Breaker-Outlets (Top of Control Center)

The duplex outlet located in the sidewall of the work area is protected with a 3-amp circuit breaker. The circuit breaker may trip at 110 percent of load rating but will trip at 145 percent of load rating in less than 2 seconds. Should the circuit breaker open, (pop-out button will appear), unplug the appliance plugged into the outlet and merely depress the pop-out button to reset.

1.1.3 Fluorescent/U.V. Light Switch

This switch provides on/off control for the fluorescent light and/or the ultraviolet (UV) light if present (optional). With the UV light option, the switch provides for on-center off-on operation so that both the fluorescent light and the UV light cannot be energized at the same time. The UV light is also interlocked, so it will only operate if the sliding window is closed. Proper care should be exercised when the UV light is on.

* Adapted from *Operation and Maintenance Manual* by NuAire, Inc., 2005.

Exhibit 11-7. Operating the laminar flow biological safety cabinet (continued)**1.1.4 Outlet Switch**

This switch provides on/off control for the 115 VAC power available in the outlet(s) within the cabinet work zone.

1.1.5 Blower Switch

The blower switch applies power to the internal motor/blower when in the ON position. The blower switch also has a second set of poles, which are available for use as a contact closure for an exhaust system. In addition, power can be applied to the accessory outlet located on the upper left corner of the cabinet, behind the front window assembly.

The purpose of the outlet is to provide “switched” power for the following (see also 8.1.11):

- Exhaust transition with integral blower; or
- Low power appliance, such as the low airflow alarm or power capper.

The rating of the outlet is 115 VAC at 2 amp maximum.

1.1.6 Indicator Light

An indicator light is located above the blower on/off switch and indicates when power is applied to the blower.

Exhibit 11-7. Operating the laminar flow biological safety cabinet (continued)

1.1.7 Audible Alarm Enable

As the sliding window is raised above its normal working height, a micro switch located in the glide channel activates both an audible and visual alarm. This switch disables the audible alarm but will not disable the red indicator visual alarm.

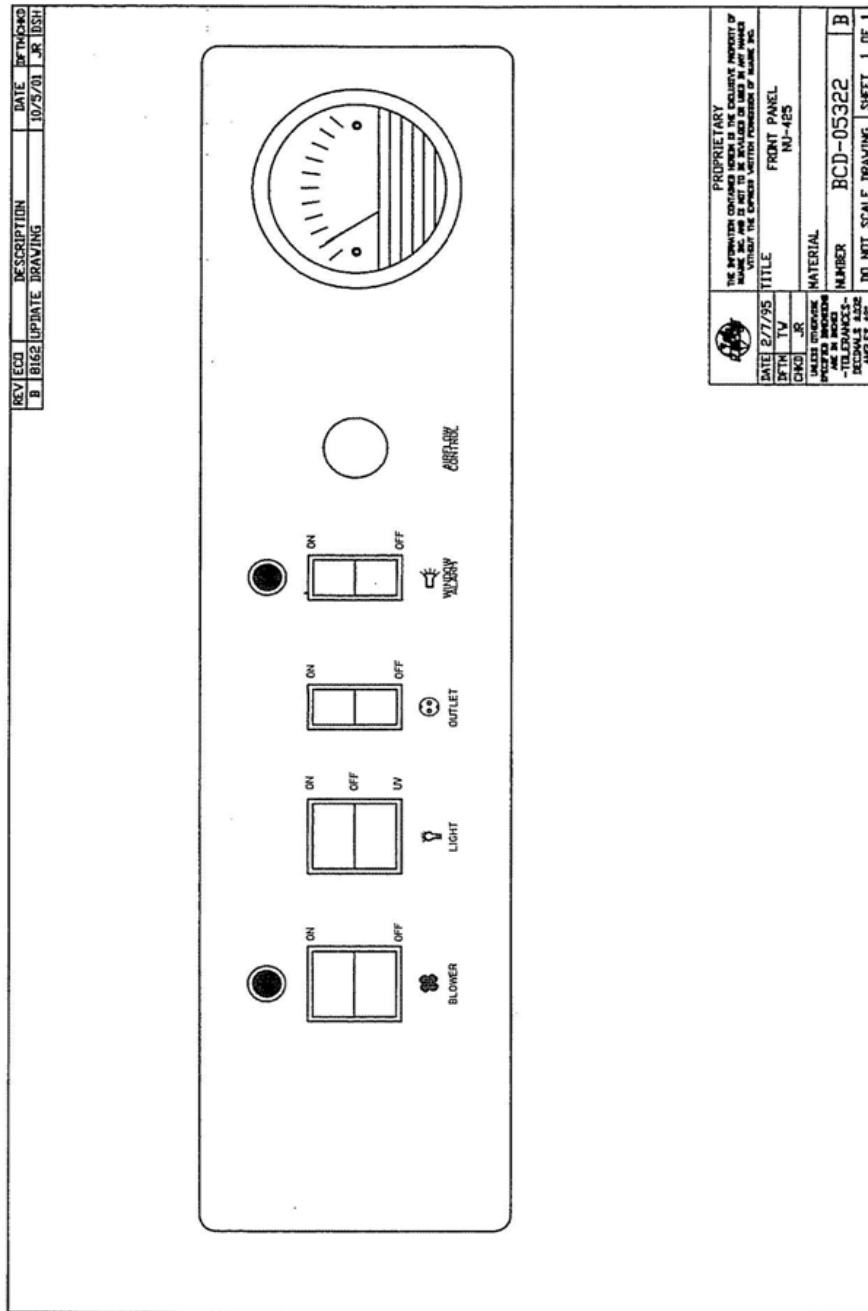

Exhibit 11-7. Operating the laminar flow biological safety cabinet (continued)**1.1.8 Airflow Control**

The operating airflows within the cabinet (i.e., 70 LFPM (.35 m/s) downflow and 105 LFPM (.53 m/s) air inflow barrier) are controlled by a potentiometer and an exhaust damper. The potentiometer controls the operating voltage applied to the motor/blower. The potentiometer is adjustable over 270 degrees with a slotted screwdriver, which varies the applied voltage from 70 to 115 VAC. THIS ADJUSTMENT SHOULD ONLY BE MADE BY A QUALIFIED TECHNICIAN EMPLOYING THE PROPER INSTRUMENTS IN ORDER TO INSURE AIRFLOWS PER NSF STD. NO. 49.

1.1.9 Magnehelic Gauge

The unit is equipped with a magnehelic gauge. The magnehelic gauge displays the static pressure within the pressure plenum supplying the downflow and exhaust filters. The gauge is calibrated in “inches of water gauge” pressure. As the HEPA filters load with particulate matter, the amount of static pressure will increase, giving an indication of the “health” of the cabinet. The initial pressure reading will be approximately 0.05-0.550 w.g. depending on altitude from sea level.

1.1.10 Sliding Window Operation

The cabinet has a full counter balanced and removable sliding tempered glass window with two operational features. As the window is raised above its specified operating height, an audible alarm alerts the operator of possible compromised personnel protection. At the same time, an audible and visual alarm is activated. The audible alarm may be switched off while the visual alarm remains until lowered to the safe operating position. When the window is lowered below 2 inches (50 mm), the motor/blower automatically shuts down, to prevent stress on the motor/blower in the form of overheating. The maximum window height is 19 1/2 inches (495 mm).

Exhibit 11-7. Operating the laminar flow biological safety cabinet (continued)**1.1.11 Convenience/Accessory Outlet**

A convenience/accessory outlet is located in the upper left hand corner in back of the window assembly. The outlet is normally wired “hot” through the motor/blower circuit breaker. If an accessory is purchased, the outlet is defined as an accessory outlet supplying 115 VAC at 2.0 Amp maximum, and is wired to the blower switch (see electrical schematic).

1.2 Operating Guidelines

The intent herein is to present general operational guidelines that will aid in the use of the Laminar Flow Biological Safety Cabinet (LFBSC) to control airborne contaminants of low to moderate risk as stated in Technical Report No. FPS 56500000001 prepared by Dow Chemical U.S.A. for the National Cancer Institute, May 1, 1972.

Procedure protocols defined in terms of the barrier or control concepts unique to LFBSC must be developed in order to obtain a maximum potential for safety and protection. The pre-planning necessary to develop these protocols is based on several fundamental considerations, each of which will contribute to optimum benefits from the equipment:

- Know your “safe working area”
- Minimize disruption of “air curtain”
- Minimize room activity
- Utilize unidirectional airflow
- Employ aseptic techniques

Exhibit 11-7. Operating the laminar flow biological safety cabinet (continued)**1.2.1 Know Your “Safe Working Area”**

The LFBSC safe working area is basically the worktray or depressed area. All work should be performed on or above the worktray. The area on or above the front grill is a non-safe working area.

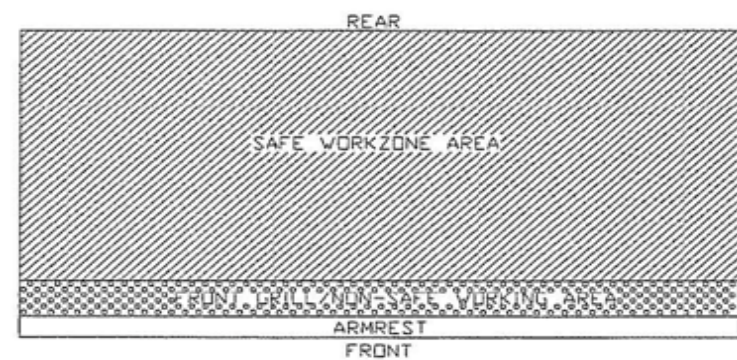
**1.2.2 Minimize Penetration of “Air Curtain”**

The minimum number of items necessary should be placed into the cabinet to prevent overloading, but the work should also be planned to minimize the number of times an operator’s hands and arms must enter and leave the air curtain at the open face. The ideal situation is to have everything needed for the complete procedure placed in the hood before starting, so that nothing need pass in or out through the air barrier at the face until the procedure is completed. This is especially important in working with moderate risk agents.

Unnecessary raising of the hands inside the cabinet above the level of the work opening should be avoided. This presents an inclined plane from hands to elbows along which the downflow of air may run to, and possibly out, the open face.

NOTE: When working with agents of lower risk, it is not as important for all materials to be placed in the cabinet before starting, or for the procedure to be completely finished before materials are removed. Also, the time period for a unit may be continued over a more extended period during which entries and withdrawals from the cabinet may be made.

Exhibit 11-7. Operating the laminar flow biological safety cabinet (continued)**1.2.3 Minimize Room Activity**

Activity in the room itself should be held to a minimum. Unnecessary activity may create disruptive air currents as well as interfere with the work of the operator. A person walking past the front of a cabinet can cause draft velocities up to 175 fpm (.89 m/s), **which are sufficient to disrupt the air balance of the laminar flow unit.**

1.2.4 Utilize Unidirectional Air Flow

The operator must keep two important facts in mind: (1) The air, as supplied to the work area through filters from the top, is contaminant free and (2) Airborne contamination generated in the work area is controlled by the unidirectional flow of parallel air streams in a top-to-bottom direction.

A solid object placed in a laminar air stream will disrupt the parallel flow and consequently, the capability of controlling lateral movement of airborne particulates. A cone of turbulence extends below the object and laminarity of the air stream is not regained until a point is reached downstream, approximately equal to three to six times the diameter of the object. Within the parameters of this cone, particles may be carried laterally by multidirectional eddy currents.

Transfer of viable materials and manipulations which may generate aerosols should not be performed above sterile or uninoculated materials. Items should be localized on the work surface in “clean” and “dirty” groups.

Exhibit 11-7. Operating the laminar flow biological safety cabinet (continued)**1.2.5 Employ Aseptic Technique**

The operator must not assume an attitude of “let the cabinet do it” when performing procedures within a LFBSC. Properly balanced and properly used cabinets will do an excellent job of controlling airborne contamination and containing viable agents, but the cabinet will not eliminate contact transmission of contamination. Normal laboratory contamination control procedures and basic aseptic techniques are necessary to obtain maximum benefit from the cabinet. For example, open bottle, tube or flask mounts should be kept as parallel as possible to the downflow to minimize capture of chance particulates. This precaution is merely an extension of good aseptic technique as practiced on open bench tops. The good laboratory practices designed to minimize creation and/or release of aerosols to the environment should not be discontinued.

Items of equipment in direct contact with the etiologic agent must remain in the cabinet until enclosed or until surface-decontaminated. Trays of discard pipettes must be covered before removal from the cabinet (aluminum foil may substitute for fabricated covers).

If an accident occurs which spills or splatters suspensions of etiologic agent around the work area, all surfaces and items in the cabinet must be surface-decontaminated before being removed.

1.3 Operating Sequence**1.3.1 Start Up**

Turn on cabinet blower and lights, check air intake and exhaust portals of the cabinet to make sure they are unobstructed.

Good procedure includes the decontamination or wipedown of cabinet surfaces with chemical disinfectant before work commences. This practice eliminates the need for UV lights, whose primary utility in this application is inactivation of surface contamination since the filters effectively remove all airborne contaminants. UV lights, therefore, are not recommended in the LFBSC.

Exhibit 11-7. Operating the laminar flow biological safety cabinet (continued)

Allow blowers to operate for a minimum of 15 minutes before aseptic manipulations are begun in the cabinet. If the filtered air exhausted from the unit is discharged into the room, as in some installations, an additional advantage is obtained from purification (filtration) of the room air circulated through the equipment. Because of this characteristic contributing to the quality of the laboratory environment, some owners of LFBSC leave them in operation beyond the time of actual use.

1.3.2 Wipedown

The interior surfaces of the workspace should next be disinfected (see cleaning procedures) by wiping them thoroughly with 70% alcohol or similar noncorrosive antimicrobial agents. USE OF CHLORINATED OR HALOGEN MATERIALS IN THE CABINET MAY DAMAGE STAINLESS STEEL.

1.3.3 Materials and Equipment

The apparatus and materials should next be placed into the cabinet. Care must be exercised that no items be placed over the front intake grills. Materials should be arranged so that clean, dirty (used), and virus materials are well separated. Passage of contaminated materials over uninoculated cultures or clean glassware should be avoided and transfer of viable materials should be performed as deeply into the cabinet (away from open face) as possible.

1.3.4 Air Purge

Additional purging of the workspace without user activity should be allowed for 2-3 minutes after materials and apparatus have been placed in it. This will rid the area of all “loose” contamination that may have been introduced with the items.

Exhibit 11-7. Operating the laminar flow biological safety cabinet (continued)**1.3.5 Perform Work**

The work can now be performed. The technician performing the work is encouraged to wear a long-sleeved gown with knit cuffs and rubber gloves. This will minimize the shedding of skin flora into the work area and concurrently protect the hands and arms from viable agent contamination. At a minimum, the hands and arms should be washed well with germicidal soap before and after work in the cabinet.

1.3.6 Terminal Purging and Wipedown

Following completion of work, allow the cabinet to run for a 2-to 3- minute period without personnel activity to purge the unit. The decontamination of the interior surfaces should be repeated after removal of all materials, cultures, apparatus, etc. A careful check of grills and diffuser grids should be made for spilled or splashed nutrients which may support fungus growth and resulting spore liberation that contaminates the protected work environment.

1.3.7 Shut Down

Turn off blowers and lights. Do not use cabinet as a depository for excess lab equipment during periods of non-operation.

Exhibit 11-7. Operating the laminar flow biological safety cabinet (continued)**1.4 Ergonomics**

Ergonomics, the study or accommodation of work practices is extremely important for proper cabinet usage and user health and safety. An evaluation of normal work practices should be performed with each user when working in a cabinet. Evaluation criteria should be at a minimum:

- Proper user posture
- Effective work zone layout for work practice
- Vision or sightlines

For each of the above evaluation criterion, several aids may be supplied to accommodate the user.

Ergonomic chair – Be sure feet are resting on the floor, chair foot support or foot rest. Also be sure back is fully supported with proper chair adjustments.

- Forearm/armrest support – The cabinet is provided with a forearm support on the work access opening. Periodic mini-breaks during work practice should be taken resting the forearm to avoid stress and fatigue.
- Effective work zone layout – Always prepare your work procedure to minimize reach to avoid neck and shoulder stress and fatigue. Rotating tables are optional to maximum work zone and minimize reach.
- Vision and sightline – Always prepare your work procedure to eliminate glare and bright reflections on the window. Keep your window clean and sightlines clear to your effect work zone.

Exhibit 11-7. Operating the laminar flow biological safety cabinet (continued)**1.5 Cleaning Procedures**

Cleaning the cabinet is an important function in terms of both containment and sterility. Use the following procedure to effectively clean or surface-disinfect the cabinet work zone surfaces.

- Raise the sliding window to a full-open position, if desired.
- Press the audible alarm silence or cleaning key on the front control panel to silence the audible alarm during the cleaning process.
- Apply appropriate disinfecting solution to cabinet surfaces. Most surface disinfectants require a specific contact time, depending upon the microbiological agents used within the cabinet. **Consult appropriate disinfectant documentation for proper application and safety precautions.**
- **NOTE:** Disinfectants that use chlorides and halogens will cause damage to the stainless steel surfaces if left on for long periods of time.
- After the specified contact time, wipe up excess disinfectant.

11.9 Ambient Air Temperature

Two thermometers monitor ambient temperature in the laboratory. Quality control procedures for ambient air temperatures involve checking these thermometers for damage, monitoring the temperature during each session, and documenting any unusual occurrences. Check the two wall thermometers for damage at the beginning of each stand. Notify the warehouse manager of any damage and request a new monitor.

The allowable ambient temperature range for the laboratory is 15–30°C (59–86°F).

NOTE: If the room temperature is out of allowable range since the last reading, document this in the automated Unusual Field Occurrence (UFO) utility and inform the MEC manager immediately. If using the portable air conditioner, document use for each session by way of a UFO.

11.10 Humidity Monitor

One humidity monitor monitors the humidity in the laboratory. Quality control procedures for room humidity monitoring involve checking the monitors for damage, monitoring the humidity during each session, and documenting any unusual occurrences. Check the humidity monitor for damage at the beginning of each stand. Notify the warehouse manager of any damage and request a new monitor.

The allowable room humidity range for the laboratory is <80%.

11.11 Mettler Toledo Scale

The Mettler Toledo PL 602E scale is a very sensitive precision weighing instrument with a weighing limit of 610 grams. Handle the scale with care at all times. Do not weigh anything on the scale other than urine cups and specimens. The weigh pan will get dirty during use. Clean the weigh pan as needed by removing the metal plate from the scale and cleaning with Windex. Replace the weigh pan when clean.

Always use the clear acrylic scale cover to protect the scale from damage while not in use. Use the scale cover to protect from drafts when weighing samples.

11.11.1 Initial Scale Interface Setup

1. Press and hold MENU key until the word BASIC appears.
 - Press Cal key until display shows INT.FACE
 - Press MENU key (this becomes your enter key)
2. R5232 will appear on display.
 - Press Cal key until BAUD shows Press Menu key.
 - Press Cal key until 2400 appears then hit Menu key.
3. Press Cal key until BIT.PAR shows on display. Press Menu key.
 - Press Cal key until “7/EVEN” shows. Press Menu key.
4. Press Cal key until “STOPBIT” shows. Press Menu key.
 - Press Cal key until “1 BIT” shows Press Menu key.
5. Press Cal key until “HD.SHK” shows. Press Menu key.
 - Press Cal key until “OFF” shows. Press Menu key.
6. Press Cal key until “RS.TX.E.O.L.” shows. Press Menu key.
 - Press Cal key until “CR.LF” shows. Press Menu key.
7. Press Cal key until “RS.CHAR” shows. Press Menu key.
 - Press Cal key until “ANSI.WIN” shows. Press Menu key.
8. Press and Hold Menu key until SAVE: Yes shows. Press Menu key.

The scale never really shuts off. It will go to darkened display with the words MT.GREEN. There are three ways to turn the scale on:

1. The Scale application being turned on via the computer;
2. Touching the scale plate; and
3. Pressing the on/off button.

This scale has no warm-up time and zeroes itself each time it turns on. So to wake it up via touching the scale plate, don't place urine on plate until it has zeroed itself.

11.11.2 Scale Setup

- Open the blue carrying case.
- Remove scale from case and place on the counter next to the bar code scanner.
- Verify that the scale is free of dust and debris. Clean scale with Windex and lint-free clothes.

Locate the tan serial cable taped to the counter. The serial cable has a broad end with a trapezoid input with a screw on either side. It looks like this:



Insert the male end of the cable into the back of the scale. Use the screws to firmly fasten the cable to the back of the scale.

Locate the black AC adapter power cord taped to the counter. Place the round end in the round hole labeled "Power" on the back side of the scale. The LCD display on the front of the scale should say "OFF." Remove the small, round, plastic cone protector from the top of the scale. Be sure to place the cone protector back into the blue carrying case so that it does not get lost.

Remove the weigh pan from the case lid. Gently place the pan on top of the scale, being sure to align the notch on the bottom of the pan with the bump on the right side of the cone. The pan should fit snugly and not wobble around when properly seated.

NOTE: Never move or turn over the scale without first placing the cone protector on the scale's cone.

Balance the scale using the liquid level in the back right corner of the scale. Adjust the feet of the scale by screwing them in or out until the bubble in the liquid level stays within the center circle.

11.11.3 Scale Teardown

Place the carrying case on the counter near the scale. Turn off the scale by pressing and holding the On/Off button. Hold until "OFF" appears on the LCD display. Gently remove weigh pan from scale. Slide weigh pan back into slot in lid of carrying case. Remove the protective cone cover from the carrying case and place over the cone.

Turn the scale around on the counter so the back of the scale is visible. Unplug the AC adapter power cord from the back of the scale. Tape the end of the power cord to the counter so it is easily found at the next setup.

Unplug the serial cable from the back of the scale by unscrewing the two screws and gently pulling the end of the serial cable away from the back of the scale. Tape the cord to the counter so it is easily found at the next setup.

Place the scale in the protective carrying case. Close the lid and snap black locks tightly closed so that the lid and bottom of the case do not come apart. Place the carrying case into a cabinet during relocation of the MEC between stands.

11.12 Eppendorf Pipette Care, Sterilization, Maintenance, and Calibration

The MEC laboratory has three Eppendorf Xplorer Plus electronic pipettes: one 5-100 μl , one 50-1,000 μl , and one 0.2-5.0 ml. The lab also uses 100 μ and 1,000 μl Biopur pipette tips and 5-ml bulk pipette tips. Charge the pipettes in the 4-stand charger.

Care and Maintenance

- Never use corrosive cleaning fluids, strong solvents, or abrasive polishes.
- Do not use acetone to clean the Xplorer Plus pipette.

NOTE: Do not use sharp objects to clean the Xplorer Plus pipette. Remove any contamination on the outside of the Xplorer Plus with a wet Sani-Cloth or alcohol wipe.

Disinfecting

- Carefully wipe off the outer surfaces, tip cone, and ejector sleeve with a disinfectant, such as 70% alcohol solution or a Sani-Cloth.

Xplorer Pipette Assembly and Disassembly

Exhibit 13-8 presents information and diagrams on this process.

Exhibit 11-8. Explorer pipette assembly and disassembly for pipettes < 5ml

7.5.1.1 Removing the lower part

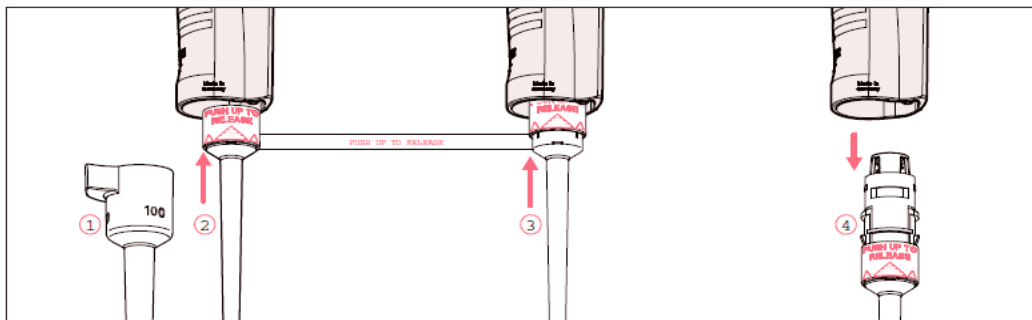

1. Keep the ejector pressed and remove the ejector sleeve ①.
2. ② and ③: On the lower part, slide the ring marked "PUSH UP TO RELEASE" up by about 5 mm until the lower part comes off.
3. ④: Remove the lower part from the upper part.

70 Eppendorf Xplorer®/Eppendorf Xplorer® plus
English (EN)

7.5.1.2 Deactivating the spring-loading action of single-channel pipettes

You can deactivate the springs of the tip cones if you want to use pipette tips which require a higher attachment force. The spring-loading action of the tip cone can be deactivated by installing the locking ring. The locking ring is included in the delivery package.

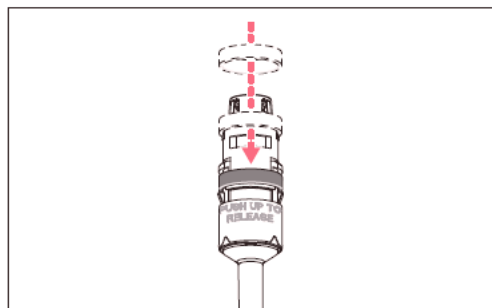

1. Push the black locking ring onto the lower part from the top by slightly squeezing the clamps on the lower part.
2. Insert the lower part into the upper part until it audibly engages.
3. Keep the ejector pressed. The ejector rod protrudes from the upper part.
4. Fit the ejector sleeve onto the ejector rod. If correctly fitted, it will engage slightly.

i Remove the locking ring to reactivate the spring-loading action.

Exhibit 11-8. Explorer pipette assembly and disassembly for pipettes < 5ml—Continued

7.5.1.4 Opening and assembling the lower part ($\leq 1000 \mu\text{L}$)

Prerequisites

The piston is in the basic position.

- i** To avoid confusing the parts, only disassemble and assemble one pipette at a time.

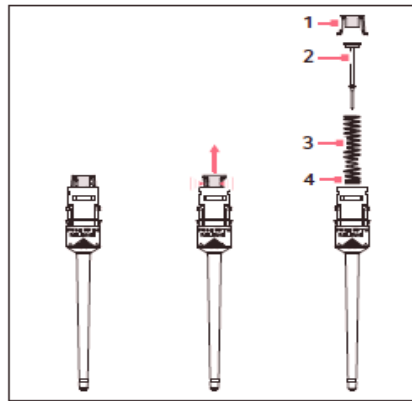
Opening the lower part

1. Slightly push the stop pins together on the piston mount (1).
2. Remove the piston mount.
3. Remove the piston (2) and the piston spring (3). The piston is under spring tension.

- i** The appearance of pistons and piston springs varies according to the individual volume versions.

Assembling the lower part

1. Carefully guide the piston and the piston spring into the cylinder. Make sure that the piston is guided correctly in the piston spring and the cylinder. There must not be any perceptible resistance. **Stop pushing as soon as any resistance is felt**. This may indicate that the piston is not positioned correctly in the cylinder. There is a risk of bending the piston if too much force is applied. Carefully pull out the piston and repeat the process correctly. In the case of piston springs with double windings (4), these windings must point downwards.
2. Keep the piston and the piston spring pressed.
3. Keep the stop pins on the piston mount pressed with the other hand.
4. Mount the piston mount so that the two stop pins engage in their retainers.
5. Gently press a pipette tip against the inserted piston. The piston must move down in the cylinder without any noticeable resistance.

Exhibit 11-8. Explorer pipette assembly and disassembly for pipettes < 5mL—Continued**7.5.2 5 mL and 10 mL single-channel**

The piston must be in its basic position before separating the lower and upper part. Press the rocker down to move the piston to its basic position.

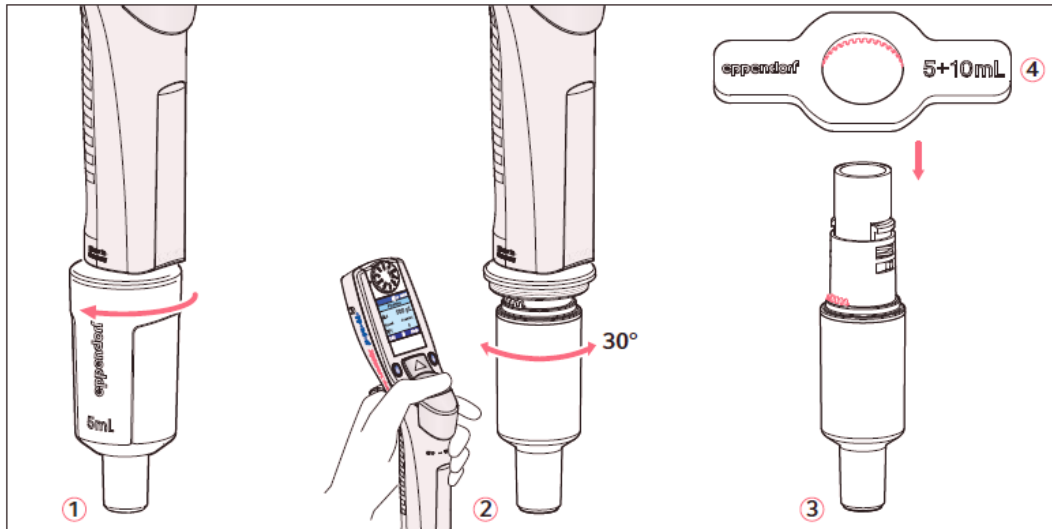

1. ①: Unscrew the ejector sleeve.
2. ②: Keep the ejector pressed and turn the lower part approximately 30° to the left or right. Pull the lower part down to cancel the magnetic coupling of the lower part. The lower part is separated from the upper part.
3. ③: Open the lower part: fit the pipette key ④ (included in the delivery package) onto the lower part. Hold the cylinder and unscrew it from the lower part. The cylinder with the tip cone is separated from the upper part of the lower part. The upper part of the lower part and the piston cannot be disassembled any further. See the next figure.

Exhibit 11-8. Explorer pipette assembly and disassembly for pipettes < 5ml—Continued

The lower part consists of the following:

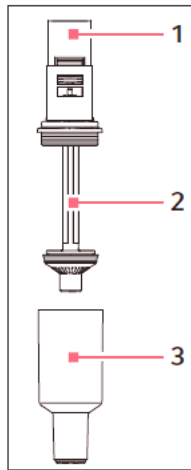

1 Upper part of the lower part

3 Cylinder and tip cone

2 Piston (with seal)
Piston with magnet

Assembly is performed in reverse order. Make sure that the magnet on the piston in the lower part is coupled with the magnet on the spindle in the upper part. After the assembly:

- ▶ Carry out a gravimetric test of the systematic and random errors.
This test ensures that no parts were confused during assembly and that the pipette has been assembled correctly.
- i** For replacing an ejector sleeve, the 5 mL and 10 mL sizes are delivered with an ejector sleeve and ejector carrier. The lower part must be removed in order to install a new ejector carrier.

Yearly Calibration

The Eppendorf Xplorer Plus pipettes are calibrated on an annual basis, while the MEC is on vacation in December. When instructed, package and send the pipettes back to the warehouse (usually the last three stands of the calendar year). The pipettes are sent to Eppendorf for recalibration by the warehouse manager. When the pipettes are received back from Eppendorf, they are sent back to the field and put into use. The calibration report is sent over to the home office to the study manager of the laboratory component.

11.13 Mini Vortex Mixer Care and Storage

The Fisher Scientific Mini Vortex Mixer is to be used inside the LFBSC to mix the MPA with serum for preservation of Vitamin C levels. This is a simple device that is to be wiped down with Sani-Cloths at the end of each day and stored in the original packaging during transport of the MEC.

**Fisher Scientific
Mini Vortex Mixer**
Model 14-955-151 Instruction Manual

The Mini Vortex Mixer is a compact, very powerful, vortex mixer designed for vortexing micro tubes of all sizes (0.4ml to 50ml). It implements dynamic balance technology to provide smooth speed control and quiet operation with low excess vibration.

I. Product Specifications:
Speed: Fixed: 2800 rpm
Operation: TOUCH mix
Head: Rubber cup standard for single tube mixing
Dimensions (WxDxH): 96 x 97 x 64mm
Weight: 0.5kg / 1 lb
Electrical: 100 to 240V, 50-60Hz, 0.6 amps
Operating environment: 4° C to 65° C;
Warranty: 2 years



II. Product Set-Up:
Place the vortex mixer on a clean, flat, stable surface and press down slightly to allow the feet to adhere. Plug the vortex mixer into a properly grounded outlet.

III. Product Operation:
Take the tube/vessel to be mixed and pressed downward against the head to activate the vortex mixing action. When finished mixing, lift the tube upward.

IV. Care and Maintenance:
No routine maintenance is required other than to keep the unit clean. Cleaning can be done with a damp cloth. Avoid the use of solvents as they may attack the rubber cup head or the ABS plastic housing.

11.14 Laboratory Quality Control Module

Document the following items in the Laboratory QC module based on the frequency described in the following table (Exhibit 11-9).

Exhibit 11-9. Laboratory QC table

Frequency	Item	Acceptable result
Start of stand		
	Freezer #3 cleaned	Yes
	Freezer #4 cleaned	Yes
	Freezer #5 cleaned	Yes
	Freezer #6 cleaned	Yes
	Refrigerator #1 cleaned	Yes
	Refrigerator #2 cleaned	Yes
	Centrifuge #1 cleaned	Yes
	Centrifuge #2 cleaned	Yes
	LFBSC cleaned	Yes
	LFBSC magnahelic gauge reading	0.050-0.550
	Class 6 one hundred gram weight +/- 1.0 g	99 - 101
	Two Class 6 three hundred gram weight +/- 6.0 g	594 - 606
Daily		
	Centrifuge #1 refrigerator temperature reading	2 - 8 °C
	Centrifuge #2 refrigerator temperature reading	2 - 8 °C
	LFBSC magnahelic gauge readings	0.050-0.550
	Workstation 2 room temperature reading	15 to 30 °C
	Workstation 3 room temperature reading	15 to 30 °C
	Humidity reading	<80%
	Class F2 twenty gram weight +/- 0.2 g	19.8-20.2
	Class F2 five hundred gram weight +/- 5.0 g	495-505
	1% ascorbic acid	Yes
	7% ascorbic acid	Yes
Weekly		
	HMX Latron and 6C Cell Control QC data transmitted?	Yes
	Flush eyewash for 5 minutes	Yes
	Reconstitute 6% Metaphosphoric Acid (MPA)	Yes
End of Stand		
	Freezer #3 cleaned	Yes
	Freezer #4 cleaned	Yes
	Freezer #5 cleaned	Yes
	Freezer #6 cleaned	Yes
	Refrigerator #1 cleaned	Yes
	Refrigerator #2 cleaned	Yes
	Centrifuge #1 cleaned	Yes
	Centrifuge #2 cleaned	Yes
	LFBSC cleaned	Yes
	Coulter printouts sent to home office	Yes
	DxH Latron and 6C Cell Control QC data transmitted?	Yes

Exhibit 11-9. Laboratory QC table—Continued

Yearly		
	Eppendorf Pipette Calibration	Date
	Hood Certification Expiration Date	Date
	Scale Weight Calibrations	Date
	DxH 800 PM	Date
	Refrigerator #1	Date
	Refrigerator #2	Date
	Freezer #3	Date
	Freezer #4	Date
	Freezer #5	Date
	Freezer #6	Date

Document all instrument quality control activities in the Laboratory QC module.

Access the Laboratory QC module.

SP ID	Sample ID	Status	Type	Gender	Age	Name	Process Status						HPV	
							UC	U	P	CB	B	PC	F	M
329869	329869	SC	P	F	12	HOWARD, CHARLES S	<input type="radio"/>	<input type="radio"/>	<input type="radio"/>	<input type="radio"/>	<input type="radio"/>	<input type="radio"/>	-	-
386827	386827	SC	P	F	26	DEEGAN, DOUG O	<input type="radio"/>	<input type="radio"/>	<input type="radio"/>	<input type="radio"/>	<input type="radio"/>	-	<input type="radio"/>	-
416714	416714	SC	P	F	16	BAILEY, ANTHONY J	<input type="radio"/>	<input type="radio"/>	<input type="radio"/>	<input type="radio"/>	<input type="radio"/>	<input type="radio"/>	<input type="radio"/>	-
499508	499508	SC	P	F	5	DEEGAN, MARK	<input type="radio"/>	<input type="radio"/>	-	<input type="radio"/>	<input type="radio"/>	-	-	-
525757	525757	SC	P	M	3	LAST NAME, PAT M	<input type="radio"/>	<input type="radio"/>	-	<input type="radio"/>	<input type="radio"/>	-	-	-
745052	745052	SC	P	F	12	TIM, SP FIRST NAME M	<input type="radio"/>	<input type="radio"/>	<input type="radio"/>	<input type="radio"/>	<input type="radio"/>	-	-	-
767995	767995	SC	P	F	39	NAME, LAST M	<input type="radio"/>	<input type="radio"/>	<input type="radio"/>	<input type="radio"/>	<input type="radio"/>	-	<input type="radio"/>	-
836040	836040	SC	P	M	54	TORRES, LUCAS T	<input type="radio"/>	<input type="radio"/>	-	<input type="radio"/>	<input type="radio"/>	-	-	<input type="radio"/>
849425	849425	SC	P	F	16	CAMPBELL, VINNIE N	<input type="radio"/>	<input type="radio"/>	<input type="radio"/>	<input type="radio"/>	<input type="radio"/>	<input type="radio"/>	<input type="radio"/>	-
919919	919919	SC	P	M	57	PAYNE, IMA L	<input type="radio"/>	<input type="radio"/>	-	<input type="radio"/>	<input type="radio"/>	<input type="radio"/>	-	<input type="radio"/>

Enter quality control activities and readings.

Select the correct activity (Start of Stand, Daily, Weekly, End of Stand, , or NCHS QC) by directing the mouse arrow to the correct heading on the top of the file, and left-click. At each stand, perform and record weekly activities on the same weekday as setup.

Mark activities as done and enter the result.

Lab Sink

Start of Stand
 Daily
 Weekly
 End of Stand
 Yearly
 NCHS QC

QC Check	Done	Result	Comment
Centrifuge 1 Refrigerator Temperature Reading (2 to 8°C)	<input type="checkbox"/>	<input type="text"/> degrees C	
Centrifuge 2 Refrigerator Temperature Reading (2 to 8°C)	<input type="checkbox"/>	<input type="text"/> degrees C	
LFBSC guage reading (0.050 to 0.550)	<input type="checkbox"/>	<input type="text"/> w.g.	
Workstation 2 room temp reading (15 to 30°C)	<input type="checkbox"/>	<input type="text"/> degrees C	
Workstation 3 room temp reading (15 to 30°C)	<input type="checkbox"/>	<input type="text"/> degrees C	
Lab Humidity Reading (<80%)	<input type="checkbox"/>	<input type="text"/> enter %	
Class F2 twenty gram weight +/- 0.2 g	<input type="checkbox"/>	<input type="text"/> enter weight	

OK Cancel

Lab Sink

Start of Stand
 Daily
 Weekly
 End of Stand
 Yearly
 NCHS QC

QC Check	Done	Result	Comment
Centrifuge 1 Refrigerator Temperature Reading (2 to 8°C)	<input type="checkbox"/>	<input type="text"/> degrees C	
Centrifuge 2 Refrigerator Temperature Reading (2 to 8°C)	<input type="checkbox"/>	<input type="text"/> degrees C	
LFBSC guage reading (0.050 to 0.550)	<input type="checkbox"/>	<input type="text"/> w.g.	
Workstation 2 room temp reading (15 to 30°C)	<input type="checkbox"/>	<input type="text"/> degrees C	
Workstation 3 room temp reading (15 to 30°C)	<input type="checkbox"/>	<input type="text"/> degrees C	
Lab Humidity Reading (<80%)	<input type="checkbox"/>	<input type="text"/> enter %	
Class F2 twenty gram weight +/- 0.2 g	<input type="checkbox"/>	<input type="text"/> enter weight	

OK Cancel

To record an activity as complete or done, use the mouse to direct the mouse arrow to the check box in the “Done” column, and left-click to insert a check mark. Press Tab or Enter to move to the Result text box.

Enter the response or reading in the Result text box.

QC Check	Done	Result	Comment
Centrifuge 1 Refrigerator Temperature Reading (2 to 8°C)	<input type="checkbox"/>	degrees C	
Centrifuge 2 Refrigerator Temperature Reading (2 to 8°C)	<input type="checkbox"/>	degrees C	
LFBSC guage reading (0.050 to 0.550)	<input type="checkbox"/>	w.g.	
Workstation 2 room temp reading (15 to 30°C)	<input checked="" type="checkbox"/>	32 degrees C	Air conditioner not working. Notified FES, Mec Manger and chief MT.
Workstation 3 room temp reading (15 to 30°C)	<input type="checkbox"/>	degrees C	
Lab Humidity Reading (<80%)	<input type="checkbox"/>	enter %	
Class F2 twenty gram weight +/- 0.2 g	<input type="checkbox"/>	enter weight	

OK Cancel

Enter “Yes” or “No” for text responses, whole numbers for rpm measurements, minutes, and seconds for timer readings, three decimals for w.g., and whole negative and positive numbers for thermometer readings in the Result text box. Press Tab or Enter to move to the Comment text box. Type any actions associated with an unexpected result in the Comment text box. Select [Tab] to move to the next line.

A red check mark on the top of the file header indicates that all QC activities associated with that requirement were successfully recorded and saved to the database.

QC Check	Done	Result	Comment
Freezer #3 cleaned?	<input checked="" type="checkbox"/>	yes (yes/no)	
Freezer #4 cleaned?	<input checked="" type="checkbox"/>	yes (yes/no)	
Freezer #5 cleaned?	<input checked="" type="checkbox"/>	yes (yes/no)	
Freezer #6 cleaned?	<input checked="" type="checkbox"/>	yes (yes/no)	

Buttons: OK, Cancel

11.14.1 Unusual Field Occurrence (UFO)

Document any unusual occurrence using the Unusual Field Occurrence utility. The hard-copy Unusual Occurrence Log (see Exhibit 11-10) is available as a backup. Record the date, Tech ID number, an explanation of the incident, and the steps to resolve the incident. Be sure to record the model and the serial number of the instrument.

Exhibit 11-10. NHANES Unusual Occurrence Log

**NHANES
UNUSUAL OCCURRENCE LOG**

Stand Number _____

Beginning Stand Date _____

Technologist Name and ID

Date

Time

Comments or Issue

Action Taken

Resolution

Reviewed by _____

Date reviewed _____

Enter information into the appropriate line(s):

- Stand Number,
- Beginning Stand Date,
- Technologist Name and ID,
- Date,
- Time,
- Comments or Issue,
- Action Taken, and
- Resolution.

NOTE: Do not enter any text in the “Reviewed by” or “Date reviewed” lines.

Print these results and file in the QC notebook. Send to the home office at the end of each stand. The data manager can answer any questions about accessing, saving, and printing this document.

11.15 Hard-Copy Supply Use Control Log

Document the lot number and expiration dates for all Vacutainer® tubes, needles, and reagents in the Supply Use Control activity of the Quality Control module. This hard-copy Supply Use Control Log (Exhibit 11-11) is available as a backup.

Enter information into the appropriate column(s):

- Reagent or Supply Name,
- Beginning Stand Date,
- Lot Number,
- Date in Use,
- Expiration Date, and
- Technologist ID.

Print these results and file in the QC notebook. Send to the home office at the end of each stand. The data manager can answer any questions about accessing, saving, and printing this document.

11.16 Power Loss and Laboratory Operations

Three scenarios may occur if power is lost to the MEC. Scenario 1 occurs when power is lost during an exam session and there is no backup generator. Scenario 2 occurs when power is lost when the MEC is not conducting a session. Scenario 3 occurs when power is lost but there is a backup generator available. Procedures to address each scenario are described in detail.

11.16.1 Scenario 1—Power Loss During Exam Session with No Backup Generator

If a power loss occurs during a MEC session, action must be taken to either continue processing the blood or preserve the integrity of the processed specimens. The phlebotomist should not draw blood during a power loss because of safety concerns due to insufficient light.

Centrifuges

Overview. There are two centrifuges in each MEC: both centrifuges are operated at refrigerated (2-8°C) temperatures. All blood tubes can be spun in the refrigerated centrifuge.

While power is generally required to open or unlock the centrifuge door, an emergency pull cord under the centrifuge will allow the technologists to open the door to retrieve the blood tubes if a power failure occurs.

Consequences. All blood tubes can remain in the locked centrifuge for up to 4 hours.

Actions. During a power failure, pull the emergency pull cord under the centrifuge to open in order to retrieve the blood tubes from the centrifuge. Aliquot the serum and plasma into the vessels if the serum or plasma has sufficiently separated from the cells.

Laminar Flow Hood

Overview. The technologists require the laminar flow hood to process the blood for two reasons: (1) the hood provides an uncontaminated or clean environment for processing environmental blood specimens; (2) the hood is required to provide a full-face shield in case of an accidental blood splash. In addition, the outlet in the hood provides power to the electronic pipettes. The electronic pipette is required to perform an accurate dilution for vessel 3 (RBC Folate).

Consequences. The environmental specimens may become contaminated. The pipette will lose battery power after ~60 minutes.

Actions. Complete an Unusual Occurrence Log to document the SP IDs of the samples processed without a fully functioning hood. This information is subsequently recorded in an annual summary for NCHS.

- Attach the comment “equipment failure” to vessels 3 and 110.
- Process vessel 3 immediately so that the specimens are not lost due to battery failure.

Freezers and Refrigerators

Overview. There are four freezers and two refrigerators in each MEC lab. The refrigerators and freezers are located in a stacked configuration across from the Coulter. Three freezers are stacked on top of the rack and two refrigerators with the remaining freezer are located on the bottom. Refrigerators and freezers are numbered according to which port they are in on the TempGuard system. Freezers are numbered 3-6 and the refrigerators are numbered 1 and 2. Port 7 is for room temperature monitoring. Refrigerant gel packs are distributed and stored in the freezers. Most specimens are stored in various plastic vials and the vials are placed in cardboard boxes with grids; the cardboard boxes are then stored in the freezers and refrigerators. In addition, some blood tubes (vessels 4, 18, and 54), swabs (vessel 140), the HPV oral rinse (vessel 129), the fluoride water (vessel 144), and the Coulter and pregnancy controls are stored in the refrigerator.

Consequences. Specimen integrity is affected if frozen specimens thaw or if refrigerated specimens reach ambient temperature. Some analytes are more sensitive than other analytes. A full freezer takes approximately 3 hours to rise from -20°C to -10°C; a half-filled freezer takes 2 hours and 25 minutes to rise to -10°C; and a one-quarter-filled freezer takes 1 hour and 45 minutes to rise to -

10°C. Once the temperature reaches -10°C the staff has approximately 30 minutes before the specimens thaw.

Actions

- Do not open the freezer or refrigerator doors, if possible.
- **Refrigerators.** After 30 minutes or when the TempGuard reading reaches 7°C, add 14 frozen gel packs (stored in freezer #6) to the center of each refrigerator. Alternatively, add 25 pounds of ice cubes or blocks to each refrigerator. Do not add dry ice to the refrigerators; this will cause the refrigerator to explode.
- **Freezers.** Contact the local dry ice company and order 200 pounds of dry ice or check the dry ice bin from Monday's shipment. Obtain four large ice chests or coolers; each cooler should hold the boxes from one freezer and 50 pounds of dry ice. Within 2 hours or when the TempGuard reading reaches -10°C, move the containers (boxes) to the ice chests and add 50 pounds of dry ice to each ice chest. Alternatively, move the containers to Styrofoam shippers and distribute the dry ice across the shippers. Do not add dry ice to the freezers; this will cause the freezer to explode.

Coulter DxH 800

Overview. The Coulter consists of the DxH 800, the monitor, hard drive, and printer. The DxH will not function without the hard drive and monitor. The blood components for the CBC (complete blood count) are stable for a maximum of 24 hours when stored at room temperature.

Consequences. None.

Actions. None.

11.16.2 Scenario 2—Power Loss When the MEC Is Not Conducting Exams

If the power loss occurs when the MEC is not conducting a session, the freezers and refrigerators require action to protect the integrity of the specimens. The lab staff can continue to ship if all the ISIS processes are complete. If the ISIS processes are not complete, the lab staff can still pack the shippers and complete the ISIS process once power is restored.

Freezers and Refrigerators

Overview. All three MECs now have the Temperature Guard system installed. This system monitors the room temperature and the internal temperature of the refrigerators and freezers in the MEC laboratory. When the system detects a significant increase in the temperatures, it begins calling designated staff. The MEC managers and FES have been identified as those individuals responsible for responding to the call by typing in the response code. The temperature increase could be confined to one freezer or refrigerator, to multiple units, or all units. The temperature increase could be due to any number of circumstances such as a loss of power because a circuit breaker tripped, or due to a compressor malfunction or failure. Whoever enters the code must act to prevent loss of biological specimens. The Temperature Guard temperature trigger was established to allow 30 minutes of travel time. After 30 minutes, frozen specimens may begin to thaw.

Consequences. Same as scenario #1.

Actions

- Examine each TempGuard reading to verify which unit(s) is/are affected.
- **Refrigerators.** If one refrigerator has been affected, move all the specimens to the other refrigerator. If both refrigerators have been affected, keep the specimens cold by adding 14 frozen gel packs (stored in freezer #6) to the center of each refrigerator. Alternatively, add 25 pounds of ice cubes or blocks to each refrigerator. Do not add dry ice to the refrigerators; this will cause the refrigerator to explode.
- **Freezers.** If only one freezer has been affected, move all the specimens from the affected unit to an unaffected unit. If more than one freezer has been affected and there is sufficient space in the unaffected freezers to accommodate the specimens, move the specimens to the other unaffected freezers. If there is insufficient space to accommodate the frozen specimens in the unaffected units, or if all four freezers are affected, try to reach the chief medical technologist or any of the staff medical technologists to assist. Contact the local dry ice company and order 200 pounds of dry ice or check the dry ice bin from Monday's shipment. Obtain four large ice chests or

coolers; each cooler should hold the boxes from one freezer and 50 pounds of dry ice. Within 2 hours or when the TempGuard reading reaches -10°C , move the containers (boxes) to the ice chests and add 50 pounds of dry ice to each ice chest. Alternatively, move the containers to Styrofoam shippers and distribute the dry ice across the shippers. Do not add dry ice to the freezers; this will cause the freezer to explode.

- Leave a note on the unit indicating the new location of the specimens.
- Turn off the affected unit, by flipping the corresponding wall switch to the left of the units.

11.16.3 Scenario 3—Power Loss With a Backup Generator

If the power loss occurs when the MEC is conducting a session and there is a backup generator available, continue to monitor the temperature of the freezers and refrigerators and assess the situation with the MEC manager. If the temperature approached the established thresholds, the FES will:

- Retrieve the generator from the trailer belly compartment,
- Retrieve the power strip,
- Plug the freezers into the power strip,
- Start the generator, and
- If both refrigerators have been affected, keep the specimens cold by adding 14 frozen gel packs (stored in freezer #6) to the center of each refrigerator. Alternatively, add 25 pounds of ice cubes or blocks to each refrigerator.

If a power loss occurs and the MEC is not conducting a session, the freezers and refrigerators require action to protect the integrity of the specimens. The TempGuard system alerts the MEC manager and/or FES that the temperature of the freezers and/or refrigerators has exceeded established thresholds. The MEC manager or FES must respond to the call, travel to the MEC immediately, and do the following:

- Retrieve the generator from the trailer belly compartment.
- Retrieve the power strip.
- Plug the freezers into the power strip.
- Start the generator.

- If both refrigerators have been affected, keep the specimens cold by adding 14 frozen gel packs (stored in freezer #6) to the center of each refrigerator. Alternatively, add 25 pounds of ice cubes or blocks to each refrigerator.

Appendix A

International Air Transport Associate (IATA) Dangerous Goods Regulations January 2017

Appendix A

International Air Transport Association (IATA) Dangerous Goods Regulations

A.1 General Provisions

Dangerous goods can be transported safely by air transport provided certain principles are strictly followed. The International Air Transport Association (IATA) publishes dangerous goods regulations. NHANES shipments fall under these regulations because diagnostic specimens (UN 3373) are packed in dry ice, which is classified as dangerous goods, and shipped via Federal Express, which uses air transport.

Dangerous goods are articles or substances that are capable of posing a significant risk to health, safety, or to property, when transported by air and which are classified as to the type of hazard. The IATA Dangerous Goods Regulations are applicable to all shippers and agents that offer consignments of dangerous goods to airlines. A shipper must comply fully with these regulations when offering a consignment of dangerous goods to IATA member airlines, and to airlines participating in IATA interline agreements for cargo. Before offering any package for air transport, the shipper must comply with the following specific responsibilities (1.3.2).*

- A shipper must provide such information to his employees as will enable them to carry out their responsibilities with regard to the transport of dangerous goods by air.
- The shipper must ensure that the articles or substances are not prohibited for transport by air.
- The articles or substances must be properly identified, classified, packed, marked, labeled, and documented in accordance with IATA regulations.
- Before a consignment of dangerous goods is offered for air transport, all relevant persons involved in its preparation must have received training to enable them to carry out their responsibilities.

The successful application of regulations concerning the transport of dangerous goods and the achievement of their objectives are greatly dependent on the appreciation of all individuals concerning the tasks involved and on a detailed understanding of the regulations. Initial and

* Notations in parentheses throughout this appendix represent the appropriate section in the *IATA Dangerous Goods Regulations*.

recurrent training programs achieve this for all persons concerned in the transport of dangerous goods. Training must be provided or verified upon the employment of a person in a position involving the transport of dangerous goods by air (1.5.0.2). Recurrent training must take place within 24 months of previous training to ensure knowledge is current. There is a provision for a 3-month window that allows for recurrent training conducted within the final 3 months of the 24-month period to be considered to have been completed on the expiry date of the 24-month period (1.5.0.3). A test must be undertaken following dangerous goods training to verify understanding of the regulation. A certificate must be issued confirming successful completion of the test (1.5.0.4).

Training curricula must include (1.5.2.2):

- General familiarization aimed at providing familiarity with IATA general provisions;
- Function-specific training in the requirements applicable to the function for which that person is responsible; and
- Safety training to cover the hazards presented by dangerous goods, safe handling, and emergency response procedures.

A record of training must be maintained, which must include the following (1.5.5):

- The individual's name;
- The most recent training completion date;
- A description, copy, or reference to training materials used to meet the training requirement;
- The name and address of the organization providing the training; and
- Evidence which shows that a test has been completed satisfactorily.

Training Curricula (Table 1.5A)

Aspects of transport of dangerous goods by air with which packers should be familiar, as a minimum include:

- General philosophy;
- Limitations;

- General requirements for shippers;
- Classifications;
- List of dangerous goods;
- General packing requirements;
- Packing instructions;
- Labeling and marking;
- Shipper's Declaration and other relevant documentation; Recognition of Undeclared Dangerous Goods; Provisions for passengers and crew; and
- Emergency procedures.

A.2 Limitations

Some dangerous goods are too dangerous to be carried by aircraft, others may be carried on cargo aircraft only, and some are acceptable on both cargo and passenger aircraft. A number of limitations are placed on dangerous goods which are permitted to be transported by air. These limitations are established by these Regulations (2.0).

The following goods are permitted on aircraft as checked baggage only and with the approval of the operator(s) (2.3.2).

- Dry Ice – Carbon Dioxide, solid (dry ice) in quantities not exceeding 2.5 kg (5 lbs.) per person when used to pack perishables not subject to these Regulations, provided the checked baggage (package) permits release of carbon dioxide gas (2.3.4.5).

A.3 Classifications

Dangerous goods are defined as those goods which meet the criteria of one or more of the nine UN hazard classes and, where applicable, to one of the three UN packing groups according to provisions of IATA regulations. The nine classes relate to the *type of hazard*, whereas the packing groups relate to the *degree of danger* within the class (3.0.1). The nine classes are: **Class 1** Explosives; **Class 2** Flammable Gases; **Class 3** Flammable Liquids; **Class 4** Flammable Solids, Substances Liable to Spontaneous Combustion, Substances Which, in Contact with Water, Emit Flammable Gases; **Class**

5 Oxidizing Substances and Organic Peroxide; **Class 6** Toxic and Infectious Substances; **Class 7** Radioactive Material; **Class 8** Corrosives; and **Class 9** Miscellaneous Dangerous Goods, including dry ice and non-pathogenic genetically modified organisms.

Dangerous goods are assigned to the relevant packing group according to the degree of hazard that they present (3.0.3). The three packing groups are: Packing Group 1 – high danger; Packing Group 2 - medium danger; and Packing Group 3 – low danger.

A.3.1 Division 6.2 – Infectious Substances (3.6.2)

Division 6.2 defines infectious substances as substances which are known or are reasonably expected to contain pathogens. Pathogens are defined as microorganisms (including bacteria, viruses, rickettsiae, parasites, fungi) and other agents such as prions, which can cause disease in humans or animals. (3.6.2.1).

Infectious substances must be classified in Division 6.2 and assigned to UN 2814, UN 2900, or UN 3373, as appropriate (3.6.2.2.1). Infectious substances are divided into two categories, Category A and Category B. Category A is an infectious substance which is transported in a form that, when exposure to it occurs, is capable of causing permanent disability, or life-threatening or fatal disease in otherwise healthy humans or animals. The proper shipping name for UN 2814 is *Infectious substance, affecting humans*. The proper shipping name for UN 2900 is *Infectious substance, affecting animals*. Category B is an infectious substance which does not meet the criteria for inclusion in Category A (3.6.2.2.2.1). Infectious substances in Category B must be assigned to UN3373. The proper name of UN 3373 is *Biological substance Category B* (3.6.2.2.2.2).

Patient specimens for which there is minimal likelihood that pathogens are present are not subject to these Regulations if the specimen is packed in packaging that will prevent any leakage and that is marked with the words “Exempt human specimen” or “Exempt animal specimen” (3.6.2.2.3.8). The packaging must consist of three components: a leakproof primary receptacle(s), a leakproof secondary receptacle, and an outer packaging of adequate strength for its mass and intended use, and with at least one surface having minimum dimensions of 100 mm x 100mm. For liquids, absorbent material in sufficient quantity to absorb the entire contents must be placed between the primary receptacle(s) and the secondary packaging so that, during transport, any release or leak of a liquid substance will not reach the outer packaging and will not compromise the integrity of the cushioning

material. When multiple fragile primary receptacles are placed in a single secondary packaging, they must be either individually wrapped or separated to prevent contact between them (3.6.2.2.3.8).

A.3.2 Class 9 – Miscellaneous Dangerous Goods

Class 9 defines miscellaneous dangerous goods as substances and articles, which, during air transport, present a danger not covered by other classes (3.9.1.1). Included in this class is solid carbon dioxide, or dry ice. Dry ice is regulated by packing instruction 954.

A.3.3 List of Dangerous Goods

UN 3373 *Biological substance Category B* specimens must comply with packing instruction 650 (p. 540).

Dry ice is classified as UN number 1845 and is classified as Class 9 dangerous goods. Shipping packaging must be labeled with a Miscellaneous Class 9 label. A maximum net quantity per package is 200 kg or 441 lb. The relevant packing instruction is 954. A special provision directs that packing tests are not considered necessary and when dry ice is used as a refrigerant for other dangerous goods loaded in a unit load device or other type of pallet, the quantity limits per package of 200 kg do not apply.

A.4 General Packing Provisions

The shipper is responsible for all aspects of the packing of dangerous goods in compliance with these Regulations (5.0.1.1).

Dry ice (solid carbon dioxide) is produced by expanding liquid carbon dioxide to vapor and “snow” in presses that compact the product into blocks. Dry ice is used primarily for cooling and can cause severe burns (its temperature is about -79° C) to skin in case of direct contact. When dry ice (solid carbon dioxide) converts (sublimates) directly to gaseous carbon dioxide, it takes heat from its surroundings. The resulting gas is heavier than air and can cause suffocation in confined areas as it displaces air. Packages containing dry ice must be designed and constructed to prevent buildup of pressure due to release of carbon dioxide gas.

Dangerous goods must be packed in good quality packaging, which must be strong enough to withstand the shocks and loadings normally encountered in transport. Packages must be constructed and closed as to prevent any loss of contents when prepared for transport, which might be caused under normal conditions of transport, by vibration, or by changes in temperature, humidity, or pressure (resulting from altitude, for example) (5.0.2.4.1).

New, remanufactured, reused, or reconditioned packaging must be manufactured and tested under a program of quality assurance to ensure that such packaging meets requirements (5.0.2.5).

Packaging for which retention of liquid is a basic function, must be capable of withstanding, without leakage, an internal pressure that produces a pressure differential of not less than 95 kPa for liquids in packing group III, Class 3, or Division 6.1 (5.0.2.9).

Packaging used for solids, which may become liquid at temperatures likely to be encountered during air transport, must also be capable of containing that substance in the liquid state (5.0.2.10).

Inner packaging – cushioning material: Inner packaging must be packed, secured, or cushioned in an outer packaging in such a way that, under normal conditions of transport, they cannot break, be punctured, or leak their contents into outer packaging and so as to control their movement (5.0.2.12.1).

A.4.1 Packing Instruction 650 - UN 3373

Packaging must be of good quality materials, strong enough to withstand the shocks and loading normally encountered during transport, including trans-shipment between transport units and warehouses as well as removal from a pallet or overpack for subsequent manual or mechanical handling. Packaging must be constructed and closed to prevent any loss of contents when prepared for transport, which might be caused under normal conditions of transport, by vibration, or by changes in temperature, humidity, or pressure.

The packaging must consist of three components:

1. A primary receptacle(s);
2. A secondary packaging; and
3. A rigid outer packaging.

Primary receptacles must be packed in secondary packaging in such a way that, under normal conditions of transport, they cannot break, be punctured, or leak their contents into secondary packaging. Secondary packaging must be secured in outer packaging with suitable cushioning material. Any leakage of the contents must not substantially impair the protection properties of the cushioning material or of the outer packaging.

Packages must be prepared as follows:

650(a) for Liquids

- The primary receptacle(s) must be leakproof and must not contain more than 1 L.
- The secondary packaging must be leakproof.
- If multiple fragile primary receptacles are placed in a single secondary packaging, they must be individually wrapped or separated to prevent contact between them.
- Absorbent material must be placed between the primary receptacle and the secondary packaging. The absorbent material, such as cotton wool, must be in sufficient quantity to absorb the entire contents of the primary receptacle (so that any release of the liquid substance will not compromise the integrity of the cushioning material) or of the outer packaging.
- The primary receptacle or the secondary packaging must be capable of withstanding, without leakage, an internal pressure producing a pressure differential of not less than 95 kPa in the range of -40°C to +55°C (-40°F to 130°F).
- The outer packaging must not contain more than 4 L.

650(b) for Solids

- The primary receptacles must be siftproof and must not exceed the outer packaging weight limit.

- The secondary packaging must be siftproof.
- If multiple fragile primary receptacles are placed in a single secondary packaging, they must be individually wrapped or separated to prevent contact between them.
- The outer packaging must not contain more than 4 kg. This includes ice, dry ice, or liquid nitrogen when used to keep specimens cold.
- If there is any doubt as to whether or not residual liquid may be present in the primary receptacle during transport then a packaging suitable for liquids, including absorbent material, must be used.

Package Testing

- Each completed package must be capable of successfully passing the following drop tests described in 6.5.1.1 except that the height of the drop must not be less than 1.2m. Following the appropriate drop sequence, there must be no leakage from the primary receptacle(s) which must remain protected by absorbent material, when required, in the secondary packaging.

For Liquids and Solids

- An itemized list of contents must be enclosed between the secondary packaging and the outer packaging.
- Packages must have one side with dimensions of not less than 100 mm x 100 mm (4 in. x 4 in.)
- For transport, the mark illustrated below must be displayed on the external surface of the outer packaging on a background of contrasting color and must be clearly visible and legible. The mark must be in the form of a square set at an angle of 45° (diamond-shaped) with each side having a length of at least 50 mm (2 in.), the width of the line must be at least 2 mm and the letters and numbers must be at least 6 mm high.
- The proper shipping name “Biological Substance, Category B” letters at least 6 mm high must be marked on the outer package adjacent to the diamond-shaped mark.



Unless all package markings are clearly visible, the following conditions apply when packages are placed in an overpack:

- The overpack must be marked with the work “Overpack;” and
- The package markings must be reproduced on the outside of the overpack.

Specific Requirements – Refrigerated or Frozen Specimens: Ice, Dry Ice, and Liquid Nitrogen

- When dry ice or liquid nitrogen is used to keep specimens cold, all applicable requirements of these Regulations must be met. When used, ice or dry ice must be placed outside the secondary packaging or in the outer packaging or an overpack. Interior supports must be provided to secure the secondary packagings in the original position after the ice or dry ice (solid carbon dioxide) has been dissipated. If ice is used, the packaging or overpack must be leakproof. If dry ice (solid carbon dioxide) is used, the outside packaging or overpack must be designed and constructed to permit the release of carbon dioxide gas to prevent a build-up of pressure that could rupture the packaging.
- The primary receptacle and the secondary packaging must maintain their integrity at the temperature of the refrigerant used as well as the temperatures and the pressures, which could result if refrigeration were to be lost.
- Infectious substances assigned to UN 3373 which are packed and marked in accordance with this packing instruction are not subject to any other requirement of these regulations except for the following:
 - (a) The name, address, and telephone number of the shipper and consignee must be provided on each package;
 - (b) The name and telephone number of a person responsible must be provided on the air waybill or on the package;
 - (c) The classification must be in accordance to 3.6.2 (see Section A.3.1);
 - (d) The incident reporting requirements in 9.6.1 must be met; and
 - (e) The inspection for damage or leakage requirements in 9.4.1 and 9.4.2.

9.6.1 – An operator must report dangerous goods accidents or incidents to the appropriate authorities of the State of the operator and the State in which the accident or incident occurred, in accordance with the reporting requirements of those appropriate authorities.

9.4.1 – Packages and overpacks containing dangerous goods must be inspected for signs of damage or leakage upon unloading from the aircraft or unit load device. If evidence of damage or leakage is found, the position where the dangerous goods or unit load was stowed on the aircraft must be inspected for damage or contamination and any hazardous contamination removed. The special responsibilities of operators regarding infectious substances are detailed in 9.4.2. (9.4.1)

9.4.2 – If any person responsible for the carriage of packages containing infectious substances becomes aware of damage to or leakage from such a package, that person must:

- Avoid handling the package or keep handling to a minimum;
 - Inspect adjacent packages for contamination and put aside any that may be contaminated;
 - Inform the appropriate public health authority, and provide information on any other countries of transit where persons may have been exposed to danger; and
 - Notify the shipper and/or consignee.
- If an air waybill is used, the “Nature and Quantity of Goods” box should show the text “BIOLOGICAL SUBSTANCE, CATEGORY B.”
 - A Shipper’s Declaration for Dangerous Goods is not required.
 - Clear instructions on filing and closing such packages must be provided by packaging manufacturers and subsequent distributors to the shipper or to the person who prepares the package to enable the package to be correctly prepared for transport.

A.4.2 Packing Instruction 954 - Dry Ice (p. 587)

This instruction applies to UN 1845 on passenger and cargo aircraft. The General Packaging Requirements of 5.0.2 must be met.

Dry ice (solid carbon dioxide), when offered for transport by air, must be in packaging designed and constructed to permit the release of carbon dioxide gas and to prevent a build-up of pressure that could rupture the packaging.

The net weight of dry ice must be marked on the outside of the package.

Arrangements between the shipper and operator(s) must be made for each shipment to ensure that ventilation and safety procedures are followed.

When a Shipper's Declaration is not required, the following information as required by 8.2.3 for dry ice (solid carbon dioxide) must be contained in the "Nature and Quantity of Dangerous Goods" box on the air waybill:

- UN 1845;
- Proper shipping name (**Dry Ice** or **Carbon Dioxide, solid**);
- 9 (the word "Class" may be included prior to the number "9");
- The number of packages; and
- The net weight of dry ice in each package.

The net weight of the dry ice must be marked on the outside of the package.

A.5 Packing Specifications and Performance Tests

Performance tests are designed to ensure that there will be no loss of contents under normal transport conditions. The severity of the tests on a packaging is dependent on the intended contents, taking account of the degree of danger; that is, packing group, relative density (specific gravity), and vapor pressure (for liquids) (6.3.0.2).

The design of each packaging type must be tested as provided in accordance with procedures established by IATA regulation (6.3.1). Tests must be successfully performed on each packaging type before such packaging is used (6.3.1.1.1).

A.6 Marking and Labeling

All markings must be so placed on packages or overpacks that they are not covered or obscured by any part of or attachment to the packaging or any other label or marking (7.1.3.1).

All markings must be:

- Durable and printed or otherwise marked on, or affixed to, the external surface of the package or overpack;
- Readily visible and legible;
- Able to withstand open weather exposure without a substantial reduction in effectiveness; and
- Displayed on a background of contrasting color (7.1.3.2).

Unless all markings representative of all dangerous goods in the overpack are clearly visible, the overpack must be marked with the word “Overpack” (7.1.4).

Each package must be marked durably and legible on the outside with each of the following:

- The proper shipping name of the contents and the corresponding UN numbers (7.1.4.1a) (BIOLOGICAL SUBSTANCE, CATEGORY B is UN 3373 and dry ice is UN 1845);
- The full name and address of the shipper and the consignee (7.1.4.1b);
- The NET Quantity of dry ice contained in each package or overpack must be shown. The quantity must be marked on each package or overpack adjacent to the UN number and Proper Shipping Name (7.1.4.1e)
- The name and telephone number of a responsible person (7.1.4.1f); and
- For packages containing UN 3373: - “BIOLOGICAL SUBSTANCE, CATEGORY B.” (7.1.4.1h).

Empty Packaging

- Other than Class 7, packaging which previously contained dangerous goods must be marked as required for those dangerous goods unless steps such as cleaning, purging of vapors, or refilling with a nondangerous substance are taken to nullify any hazard (7.1.5.6).

There are two types of labels: hazard labels (in the shape of a square set at 45°) which are required for most dangerous goods in all classes and handling labels (in various rectangular shapes), which are required, either alone or in addition to hazard labels for some dangerous goods (7.2.2.2).

A primary hazard label is specified for each listed article and substance. A secondary hazard label or labels must also be applied for each article and substance having subsidiary risk (7.2.3.1). For Class 9

materials, the package must bear the class 9, “Miscellaneous Dangerous Goods” label as required for all dry ice shipments (7.2.3.10).

All labels must be securely affixed or printed on the packaging so that they are readily visible and legible and not obscured by any part of the packaging or by any other label (7.2.6.1a). Each label must be affixed on a background of contrasting color or must have a dotted or solid line outer border (7.2.6.1b). The label must not be folded or affixed in such a manner that different parts of the label appear on different faces of the package (7.2.6.1c). The package must be of such a size that there is adequate space to affix all required labels (7.2.6.1e).

Before empty packaging which had previously contained infectious substances is referred to the shipper, or sent elsewhere, it must be thoroughly disinfected or sanitized and any label or marking indicating that it had contained an infectious substance must be removed or obliterated. (7.2.3.12.2)

Labels must be located on the same surface of the package near the proper shipping name marking if the package dimensions are adequate (7.2.6.2.1).

A.7 Documentation

Except as otherwise specified, a “Shipper’s Declaration for Dangerous Goods” form and an “Air Waybill” must be completed for each consignment of dangerous goods (8.0.1). A “Shipper’s Declaration for Dangerous Goods” is not required for shipments containing diagnostic specimens (p. 463) or dry ice (p. 499).

If a Shipper’s Declaration is not required for dangerous goods, the Nature and Quantity of Goods” box of the Air Waybill must show in sequence (8.2.3):

- UN or ID number;
- Proper Shipping Name;
- Class or Division number;
- Number of packages; and
- Net quantity per package.

For UN 3373, it is only necessary to show the text “BIOLOGICAL SUBSTANCE; CATEGORY B” and “UN 3373.” For dry ice, it is not necessary to show the packing group and packing instruction number on the air waybill.

A.8 References

1. *IATA Dangerous Goods Regulations*, 56th Edition, effective January 1, 2015, ISBN 978-92-9233-006-4
2. *FedEx Service Guide Vol. 1*, effective June 1, 2000.

WESTAT

Certificate of Test Completion

International Air Transport Association (IATA) Dangerous Goods Regulations

Name _____

Date of Successful Exam _____

Examiner _____

Appendix B

**Biosafety
January 2017**

Appendix B

Biosafety

B. Policy for Management of Exposure to Bloodborne Pathogens

Exposure Control Plan for NHANES Training and Examinations

B.1 Introduction

The policy presented in this section is intended to serve as the written policy for the NHANES mobile examination center (MEC) staff training and main study period. It is based on the Occupational Safety and Health Administration (OSHA) Regulations for exposure to bloodborne pathogens as published in the *Federal Register* (29CFR 1910.1030), the Updated U.S. Public Health Service Guidelines for the Management of Occupational Exposure to HBV, HCV, and HIV and Recommendations for Postexposure Prophylaxis (MMWR, June 29, 2001), the CDC recommendations, Immunization of Health-Care Workers: Recommendations of the Advisory Committee on Immunization Practices (ACIP) and the Hospital Infection Control Practices Advisory Committee (HICPAC) (December 1997) and the revised Occupational Exposure to Bloodborne Pathogens: Needlestick and Other Sharps injuries; Final Rule.

This manual describes the procedures required to treat and document blood exposure injuries to MEC staff. Universal precautions are the foundation of standard operating procedures and emergency procedures throughout the exam center. MEC staff, the home office staff, and NCHS monitor compliance with these precautions and the pertinent OSHA regulations.

OSHA's rule applies to all persons occupationally exposed to blood or other potentially infectious materials. Blood means human blood, blood products, or blood components. On NHANES, the only body fluids that are collected are blood, vaginal swabs, and urine. Urine is not considered infectious unless the specimens are visibly contaminated with blood or are known to contain an infectious agent.

OSHA revised the Bloodborne Pathogens standard in conformance with the requirements of the Needlestick Safety and Prevention Act. This Act directs OSHA to: (1) revise the Bloodborne

Pathogens standard to include new examples in the definition of engineering controls along with two new definitions; (2) require that Exposure Control Plans reflect how employers implement new developments in control technology; (3) require employers to solicit input from employees responsible for direct patient care in the identification, evaluation, and selection of engineering and work practice controls; and (4) require certain employers to establish and maintain a log of percutaneous injuries from contaminated sharps.

B.2 Exposure Determination

B.2.1 MEC Employees by Group

Exposure determination is based on the definition of occupational exposure without regard to personal protective clothing and equipment. Job classifications within the work environment are reviewed for exposure and two groups of exposures are identified: Category I job classifications in which **all** the employees have occupational exposure, and Category II classifications in which **some** of the employees have occupational exposure. Where all employees have occupational exposure, it is not necessary to list specific work tasks. Where only some employees have occupational exposure, procedures causing occupational exposure must be listed.

Occupational exposure for NHANES staff is categorized as follows:

Category I Exposures

- Phlebotomist
- Medical technologist
- Dentists

Category II Exposures

- Physician
- MEC manager

The physician may risk exposure in the event of an emergency in the MEC. The physician is expected to respond to any emergency and perform appropriate procedures, but this does not

include the initiation of IV fluids. The MEC manager is responsible for insuring that biohazardous waste is removed and thus may occasionally handle bagged biohazardous waste. The MEC manager is also expected to respond to emergencies and thus may risk exposure if the emergency involves a laceration.

B.3 Methods of Compliance

B.3.1 Control for Category I and Category II Exposures

Risks posed by bloodborne pathogens may be reduced through vaccination, engineering controls, employee work practices, personal protective equipment, and housekeeping procedures. Bloodborne pathogens means pathogenic microorganisms that are present in human blood and can cause disease in humans. These pathogens include, but are not limited to, hepatitis B virus (HBV), hepatitis C virus (HCV), and human immunodeficiency virus (HIV).

Because some infectious diseases can be communicable through contact with SPs and blood, all Category I and Category II staff members are advised to:

- Obtain the hepatitis B vaccine if recommended by Westat for their category of exposure; and
- Use universal precautions (see Section B.3.2) when there is a potential for exposure to blood or body fluids.

B.3.2 General - Universal Precautions

Universal Precautions is an approach to infection control. According to the concept of Universal Precautions, all human blood and certain human body fluids are treated as if known to be infectious for HIV, HBV, and other bloodborne pathogens. Universal precautions are observed to prevent contact with blood or other potentially infectious materials. Other Potentially Infectious Materials means: (1) the following human body fluids: semen, vaginal secretions, cerebrospinal fluid, synovial fluid, pleural fluid, pericardial fluid, peritoneal fluid, amniotic fluid, saliva in dental procedures, any body fluid that is visibly contaminated with blood, and all body fluids in situations where it is difficult or impossible to differentiate between body fluids; (2) any unfixed tissue or organ (other than intact skin) from a human (living or dead); and (3) HIV-containing cell or tissue cultures, organ

cultures, and HIV- or HBV-containing culture medium or other solutions; and blood, organs, or other tissues from experimental animals infected with HIV or HBV. Universal precautions are applied to procedures involving all sample persons.

B.3.3 Engineering and Work Practice Controls

Engineering and work practice controls are the primary methods used to prevent occupational transmission of HBV, HIV, and other bloodborne pathogens. Sharps disposal containers, self-sheathing needles, and biological safety cabinets are examples of engineering controls used in the NHANES.

Biological safety cabinets are similar in appearance to laboratory fume hoods and protect employees from exposure to airborne biohazards by providing an enclosed, mechanically ventilated space for them to work. A laminar flow biological safety cabinet is located in the laboratory in every MEC.

Sharps containers are liquid-tight, puncture-resistant vessels used to minimize the hazards posed by discarded needles, broken glass, scalpels, and other contaminated sharp objects. Light plastic bottles such as those that hold consumer products are unacceptable because the walls are easily penetrated by sharps. Metal, heavy-gauge plastic or laminated multi-ply cardboard containers are a much better choice.

Engineering controls isolate or remove the bloodborne pathogen hazard from the workplace. Work Practice Controls are controls that reduce the likelihood of exposure by altering the manner in which a task is performed (e.g., prohibiting recapping of needles by a two-handed technique). These include procedures for processing and handling blood and blood products, waste disposal, and personal hygiene.

Category I

Specific procedures for preventing exposures in Category I staff are as follows:

- All materials intended for reuse are inspected and decontaminated on a regular basis and are cleaned and decontaminated immediately upon visible contamination.

- Sinks that can be used for hand washing are provided in the bathrooms in trailers 1 and 4 and in the hallways in trailers 1 and 2, in the laboratory, phlebotomy room, and staff lounge in trailer 3, and in the dental exam room in trailer 4. The laboratory and dental sinks include an electronic eye on/off mechanism.
- All MEC exam staff are instructed to wash hands with soap and water after removing gloves or upon accidental skin contact with blood or body fluids, and between each SP exam.
- Employees are instructed to wash hands and any other skin with soap and water, or flush mucous membranes with water immediately or as soon as feasible following contact of such body areas with blood or other potentially infectious materials.
- Sharps should be handled with extreme care and discarded into the needle disposal containers provided in the MEC. Staff members are instructed that contaminated needles and other contaminated sharps shall not be bent, recapped, or removed. Shearing or breaking of contaminated needles is prohibited. They are required to use the shielding mechanism. Contaminated sharps means any contaminated object that can penetrate the skin including, but not limited to, needles, scalpels, broken glass, broken capillary tubes, and exposed ends of dental wires. Use of the safety shielding mechanism is mandatory.
- Discarded needles and other waste sharps must be placed in an "approved" sharps container. Care must also be taken when mounting a sharps container on the walls and cabinets to make sure the container is accessible to everyone. Immediately or as soon as possible after use, contaminated reusable sharps are placed in puncture resistant and leakproof containers until properly reprocessed. These containers are identified as containing potentially infectious materials and are not allowed to overfill.
- Employees are instructed not to eat, drink, smoke, handle contact lenses, or apply cosmetics or lip balm in the exam rooms.
- No food or drinks are kept in refrigerators, freezers, shelves, cabinets, or work surfaces in the examination rooms. An employee lounge with a refrigerator is provided for personal food storage.
- Procedures involving blood or other potentially infectious materials are performed in such a manner as to minimize splashing, spraying, spattering, or aerosolizing. For example, the splattering of blood or serum that occurs when rubber stoppers are pulled out of specimen tubes is minimized by covering the stopper with gauze before removing it and performing this procedure under the biosafety hood.
- Mouth pipetting/suctioning of blood or other potentially infectious materials is prohibited.
- Equipment should be checked and decontaminated before servicing and shipping. Decontamination means the use of physical or chemical means to remove, inactivate, or destroy bloodborne pathogens on a surface or item to the point where it is no longer

capable of transmitting infectious particles and the surface or item is rendered safe for handling, use, or disposal.

- Work surfaces and or equipment contaminated with blood or body fluids are washed with detergent and disinfected with a 1:10 or 1:100 dilution of bleach at the end of every examination session, as described in the examiner manuals.
- Protective coverings used to cover equipment and environmental surfaces are removed and replaced as soon as feasible when overtly contaminated with blood or body fluids during the exam session.
- Broken glassware is never picked up by hand, but swept up with a brush and dustpan. To minimize aerosol formation, broken glass is not dropped into a disposal container but gently placed in the container.

Category II

Although the MEC is not set up to treat or manage medical problems, medical emergencies may occur. If the staff must administer CPR, it is recommended that all staff observe the following procedures to prevent exposures:

- Wear gloves and a lab coat when performing emergency procedures. Disposable impervious lab jackets are available in the lab if needed.
- Use the disposable resuscitation masks found in designated areas.
- Follow the instructions of the MEC physician, who will direct the emergency response.
- Decontaminate and/or dispose of all emergency medical supplies.
- Change any protective equipment contaminated with blood or body fluids.
- Wash hands after removing gloves and before working with the next SP.

B.3.4 Personal Protective Equipment

Personal Protective Equipment is used when occupational exposure remains after instituting engineering and work practice controls. Personal protective equipment is specialized clothing or equipment worn by an employee for protection against a hazard. General work clothes (e.g., uniforms, pants, shirts, or blouses) not intended to function as protection against a hazard are not considered personal protective equipment.

The selection of protective equipment depends on the nature of the potential exposure but generally includes gloves, lab coats, and gowns. If there is a chance for potentially infectious material to splash into the eyes or mouth, staff members are instructed to wear face protection in the form of a mask and/or safety glasses with side shields. The employer provides all protective equipment in appropriate sizes and sufficient quantities for staff use. Hypoallergenic gloves or other alternatives are available to employees with allergic sensitivity to gloves.

Staff members other than those in Categories I or II are not expected to perform work procedures that carry risk for exposure to blood or body fluids but the following precautions are communicated to the staff in training and monitored:

- Staff should not perform any procedure or task for which they have not been trained.
- Gloves, disposable impervious lab jackets, and/or safety glasses are worn when performing venipuncture, and laboratory procedures. Personal protective equipment is provided to the staff. Disposable impervious lab jackets are provided to the medical technologists, phlebotomists, and health technologists performing the oral health examination. Reusable cloth lab coats are provided to the physician and MEC manager and are laundered by the employer if contaminated with blood or body fluids. Safety glasses are optional for the phlebotomist and are available onsite. Disposable, powder-free hypoallergenic nonlatex powder-free gloves are provided to the medical technologists, phlebotomist, and dental examiners. Wear appropriate gloves if contact with blood, or other potentially infective materials is anticipated. Never wash or decontaminate disposable gloves for reuse.
- Gloves are changed after each sample person exam or when visibly soiled with blood and/or body fluids. Disposable impervious lab jackets worn by the laboratory and phlebotomy staff are discarded when soiled and at the end of each workweek. Disposable impervious lab jackets worn by the health technologists during the oral health examination are changed when visibly soiled with blood and body fluids. All disposable impervious lab jackets are removed before leaving the work area and after a garment becomes contaminated. Place used protective equipment in appropriately designated areas or containers when being stored or discarded.

B.3.5 Housekeeping

Under the OSHA standard, all areas must be kept clean and sanitary. A cleaning schedule that includes appropriate methods of decontamination procedures has been developed for every component and is included in the component-specific procedure manuals. These procedures are included in component training programs and are part of daily component procedures. Cleaning

procedures are based on the type of surfaces, the type of contamination present, the tasks or procedures, and their location in the facility. Housekeeping staff also receive a written set of instructions for cleaning designated areas of the MEC.

The following housekeeping procedures must be observed and will be monitored by project staff:

- Clean and decontaminate all equipment and environmental and work surfaces contaminated with blood or other potentially infectious materials.
- Decontaminate work surfaces with an appropriate disinfectant after completion of procedures, immediately when overtly contaminated, after any spill of blood or other potentially infectious material, and at the end of the work shift when surfaces have become contaminated since the last cleaning.
- Remove and replace protective coverings such as plastic wrap.
- Inspect and decontaminate, on a regular basis, reusable receptacles such as bins, pails, and cans that have the likelihood for becoming contaminated. When contamination is visible, clean and decontaminate receptacles immediately, or as soon as possible.
- Place other regulated waste in closable and labeled or color-coded containers. When storing, handling, transporting, or shipping, place other regulated waste in containers that prevent leakage.
- When discarding contaminated sharps, place them in containers that are closable, puncture-resistant, appropriately labeled or color-coded, and leakproof on the sides and bottom.
- Ensure that sharps containers are easily accessible to personnel and located as close as feasible to the use area. Keep sharps containers upright throughout use, replace routinely, close when moved, and do not allow to overfill.
- Never manually open, empty, or clean contaminated sharps disposable containers.
- Discard regulated waste into appropriate containers, labeled as biohazardous waste, and seal to prevent leakage during handling, storage, and transport. Regulated Waste means liquid or semiliquid blood or other potentially infectious materials; contaminated items that would release blood or other potentially infectious materials in a liquid or semiliquid state if compressed; items that are caked with dried blood or other potentially infectious materials and are capable of releasing these materials during handling; contaminated sharps; and pathological and microbiological wastes containing blood or other potentially infectious materials. A hazardous waste company is responsible for the disposal of biohazardous waste from the MEC.

Specific methods and regular schedules for cleaning bench tops, equipment, and other environmental surfaces contaminated with potentially infectious materials are documented in the

Infection Control Manual and in the respective component procedure manuals. The time required for cleanup may be reduced if surfaces are covered before work with an impermeable, disposable covering such as plastic sheeting or absorbent bench pads.

Good housekeeping procedures are not limited to areas in which infectious materials are handled. Prudent safety practice dictates that halls and passageways are kept clear of obstructions such as carts, obsolete equipment, and shipping containers. Fire doors, other than those interconnected to smoke-detection systems, are kept closed. Stairs are not obstructed and exits are clearly marked.

Contaminated laundry is handled as little as possible and placed in labeled bags at locations where it is used. Leakproof bags are used to transport wet laundry. In addition, all employees who work with contaminated laundry wear gloves.

B.4 Hepatitis B Vaccine

The hepatitis B vaccine is made available to Category I and II MEC staff at no cost and at a reasonable time and place within 10 working days of initial assignment, and to any MEC staff following an exposure incident. Employees who refuse the hepatitis vaccine must sign the Declination Form, which is kept with the employee's medical records. Employees who have previously received the vaccine should provide evidence of antibody testing or completion of the vaccine series.

If an exposure incident occurs, the MEC manager and MEC physician must be notified immediately. The MEC physician must complete a Medical Incident Form, and the employee must receive an immediate medical evaluation to assess his or her level of vaccine protection and level of exposure. The MEC physician must also recommend an appropriate treatment regimen per the *Updated U.S. Public Health Service Guidelines for the Management of Occupational Exposure to HBV, HCV, and HIV and Recommendations for Postexposure Prophylaxis* (MMWR, June 29, 2001).

B.4.1 Procedures for Evaluating Exposure Incidents

The OSHA standard requires that following a report of an exposure incident, the employer shall make immediately available to the exposed employee a confidential medical evaluation and

follow-up. “Exposure incident” means a specific eye, mouth, other mucous membrane, nonintact skin, or parenteral contact with blood or other potentially infectious materials that results from the performance of an employee's duties. The exposure report must include at least the following elements:

1. Date and time of exposure;
2. Documentation of the route(s) of exposure, and the circumstances under which the exposure incident occurred;
3. Identification and documentation of the source individual, unless the employer can establish that identification is infeasible or prohibited by state or local law;
 - The source individual's blood shall be tested as soon as feasible and after consent is obtained in order to determine HBV, HCV, and HIV infectivity. If consent is not obtained, the employer shall establish that legally required consent cannot be obtained. When the source individual's consent is not required by law, the source individual's blood, if available, shall be tested and the results documented.
 - Results of the source individual's testing shall be made available to the exposed employee's physician, and the employee shall be informed of applicable laws and regulations concerning disclosure of the identity and infectious status of the source individual.
4. Collection and testing of blood for HBV, HCV, and HIV serological status;
 - a. The exposed employee's blood shall be collected as soon as feasible and tested after consent is obtained.
 - b. If the employee consents to baseline blood collection, but does not give consent at that time for HIV serologic testing, the sample shall be preserved for at least 90 days. If, within 90 days of the exposure incident, the employee elects to have the baseline sample tested, such testing shall be done as soon as feasible.
5. Postexposure prophylaxis, when medically indicated, as recommended by the U.S. Public Health Service;
6. Counseling; and
7. Evaluation of reported illnesses.

It is important that the employee have access to treatment for possible HBV, HCV, or HIV exposure as soon as possible after the incident because HBIG (Hepatitis B immunoglobulin), hepatitis B vaccine, and HIV PEP (postexposure prophylaxis) are most likely to be effective if administered as soon after the exposure as possible. During training, the training supervisor, the

Director of MEC Operations, Catherine Novak, will oversee the response to a needlestick or other exposure. During the examination period, the MEC physician is responsible for initiating the response, referring the employee to the nearest emergency department, notifying home office staff, and documenting the incident.

At a minimum, the evaluation and followup must include the following elements:

- Treatment of Exposure Site
 - Wounds and skin sites that have been in contact with blood or body fluids should be washed with soap and water; mucous membranes should be flushed with water. No evidence exists that using antiseptics for wound care or expressing fluid by squeezing the wound further reduces the risk of bloodborne pathogen transmission; however, the use of antiseptics is not contraindicated. The application of caustic agents (e.g., bleach) or the injection of antiseptics or disinfectants into the wound is not recommended.
- Exposure Report
 - Document the routes of exposure and how the exposure occurred on a Medical Incident Form and OSHA's Forms 300 and 301 (See Section 5.6 in Chapter 5 of the *Infection Control Procedures Manual*). The Medical Incident Form can be accessed from any exam room by clicking on the ambulance icon on the toolbar.
- Evaluation of the Employee and the Exposure
 - The employee should proceed immediately to the closest emergency department where he or she can be evaluated and counseled. Hospitals are available during all working hours, including nights and weekends. HBIG, hepatitis B vaccine, and antiretroviral agents for HIV PEP should be available for timely administration (i.e., either by providing access on site or by creating linkages with other facilities or providers to make them available off site). The evaluating emergency physician is responsible for providing postexposure management and counseling. He or she is familiar with evaluation and treatment protocols and whether the hospital has access to HBIG, hepatitis B vaccine, and antiretroviral drugs for HIV PEP.
 - The exposure will be evaluated by the hospital physician for the potential to transmit HBV, HCV, and HIV based on the type of body substance involved and the route and severity of the exposure. Blood, fluid containing visible blood or other potentially infectious fluid, can be infectious for bloodborne viruses. Exposures to these fluids through a percutaneous injury (i.e., needlestick or other penetrating sharps-related event) or through contact with a mucous membrane are situations that pose a risk for bloodborne virus transmission and require further evaluation. For HCV and HIV, exposure to a blood-filled hollow needle

or visibly bloody device suggests a higher risk exposure than exposure to a needle that was most likely used for giving an injection.

- The physician evaluating the employee must be provided with a copy of the OSHA bloodborne pathogen regulations, a description of the employee's duties relevant to the exposure incident, and documentation of the route and circumstances of exposure. Within 15 days after the evaluation of the exposed employee, the employer must obtain a copy of the report from the health care professional responsible for the postexposure evaluation and ensure that the employee receives a copy of the written opinion. The evaluating physician must provide a written opinion regarding vaccination status and postexposure evaluation and followup. The written opinion to the employer is limited to whether the vaccine is necessary, documentation of administration, and whether the employee was informed of the results of the evaluation, including any medical conditions resulting from exposure which require further evaluation or treatment. However, all diagnoses not related to the exposure incident are protected by patient/physician confidentiality and should not be included in the written report to the employer.
 - For skin exposure, followup is indicated only if it involves exposure to a body fluid previously listed and evidence exists of compromised skin integrity (e.g., dermatitis, abrasion, or open wound).
- Evaluation of the Exposure Source
- The person whose blood or body fluid is the source of an occupational exposure should be evaluated for HBV, HCV, and HIV infection.
 - The HBV, HCV, and/or HIV infection status of the source is unknown. The source person should be informed of the incident and asked to undergo testing at the emergency department or to consent to have their blood tested by an independent reference laboratory. It will be explained to the SP that a blood test is needed to determine treatment options for the exposed person. Offer to use serum that has already been collected for testing so that a second venipuncture will not be necessary. The SP may also choose to go to his or her physician to obtain the test at NHANES project expense. The SP will be asked to consent to release the results of the tests to the exposed staff person by sending the results to the staff person's physician. The SP should sign the consent form (See Exhibit 5-3 in Chapter 5 of the *Infection Control Procedures Manual*.) and a copy of the consent should be provided to the SP. If the SP refuses to be tested, the MEC physician or other supervisor named above should document the refusal in writing.
 - Procedures should be followed for testing source persons, including obtaining informed consent, in accordance with applicable state and local laws. Any persons determined to be infected with HBV, HCV, or HIV should be referred for appropriate counseling and treatment. Confidentiality of the source person should be maintained at all times.

- Testing to determine the HBV, HCV, and HIV infection status of an exposure source should be performed as soon as possible. An FDA-approved rapid HIV-antibody test kit should be considered for use in this situation, particularly if testing by EIA cannot be completed within 24 – 48 hours. Repeatedly reactive results by EIA or rapid HIV-antibody tests are considered highly suggestive of infection, whereas a negative result is an excellent indicator of the absence of HIV antibody. Confirmation of a reactive result by Western blot or immunofluorescent antibody is not necessary to make initial decisions about postexposure management but should be done to complete the testing process and before informing the source person. Repeatedly reactive results by EIA for anti-HCV should be confirmed by a supplemental test (i.e., recombinant immunoblot assay [RIBA™] or HCV PCR). Direct virus assays (e.g., HIV p24 antigen EIA or tests for HIV RNA or HCV RNA) for routine HIV or HCV screening of source persons are not recommended.
- If the exposure source cannot be tested or refuses to provide consent, information about where and under what circumstances the exposure occurred should be assessed epidemiologically for the likelihood of transmission of HBV, HCV, or HIV. Certain situations as well as the type of exposure might suggest an increased or decreased risk; an important consideration is the prevalence of HBV, HCV, or HIV in the population group (i.e., institution or community) from which the contaminated source material is derived.
- Testing of needles or other sharp instruments implicated in an exposure, regardless of whether the source is known or unknown, is not recommended. The reliability and interpretation of findings in such circumstances are unknown, and testing might be hazardous to persons handling the sharp instrument.
- The exposed employee’s physician is provided with the source individual's test result and information about the applicable disclosure laws and regulations concerning the source identity and infectious status. (This will be accomplished through the evaluating physician and not through the employer.)

A copy of all documentation related to the incident, including the Medical Incident Form and OSHA’s Forms 300 and 301, should be sent to the Director of Mobile Examination Center Operations, Catherine Novak, as soon as possible.

A more detailed description of these recommendations is in the *Updated U.S. Public Health Service Guidelines for the Management of Occupational Exposure to HBV, HCV, and HIV and Recommendations for Postexposure Prophylaxis* (MMWR, June 29, 2001). Copies of these guidelines are available in Appendix C of the *Infection Control Manual*.

B.5 Labeling

The OSHA standard requires that fluorescent orange and orange-red warning labels be attached to containers of regulated waste, to refrigerators and freezers containing blood and other potentially infectious materials, and to other containers used to store, transport, or ship blood or other potentially infectious materials. These labels are not necessary when (1) using red bags or red containers; (2) labels designate the contents of containers of blood, blood components, or blood products; and (3) individual containers of blood or other potentially infectious materials are placed in a labeled container during storage, transport, or disposal. The warning label must be fluorescent orange or orange-red, contain the biohazard symbol and the word BIOHAZARD, in a contrasting color, and be attached to each object by string, wire, adhesive, or other method to prevent loss or unintentional removal of the label.

In the MEC, labels are affixed to containers of infectious waste, centrifuges, refrigerators and freezers containing blood or body fluids, and containers used to store, transport, or ship blood or body fluids.

B.6 Communication of Hazards to Employees - Training

All MEC employees, including those designated as Category I and II, will receive information and training during their working hours regarding the OSHA regulation and their exposure category at the time of initial assignment and at no cost to the employee. The training program will be provided at least once a year thereafter. Additional training will be provided as necessary when existing tasks are modified or tasks are added that affect the employee's exposure risk. Persons conducting the training will be knowledgeable about the subject matter, and the information will be appropriate in context and vocabulary to the education level, literacy, and language of the audience. All training programs for MEC staff will include instruction in the OSHA regulations, general infection control practices, and specific infection control procedures relevant to each examination component. The training must include the following elements:

- How to obtain a copy of the regulatory text and an explanation of its contents;
- Information on the epidemiology and symptoms of bloodborne diseases;
- Ways in which bloodborne pathogens are transmitted;

- Explanation of the exposure control plan and how to obtain a copy;
- Information on how to recognize tasks that might result in occupational exposure (categories of exposure);
- Explanation of the use and limitations of work practice and engineering controls, and personal protective equipment;
- Information on the types, selection, proper use, location, removal, handling, decontamination, and disposal of personal protective equipment;
- Information on hepatitis B vaccination such as safety, benefits, efficacy, methods of administration, and availability;
- Information on whom to contact and what to do in an emergency;
- Information on how to report an exposure incident and on postexposure evaluation and followup;
- Information on warning labels, and signs, where applicable, and color coding;
- Information on other infectious disease concerns in the MEC; and
- Question and answer session on any aspect of the training.

B.7 Recordkeeping

The exposure control plan is reviewed and updated at least annually or whenever new tasks and procedures affect occupational exposure. A copy of the Exposure Plan is kept in every copy of the *Infection Control Manual*. Copies of this manual are kept in the staff lounge, in the physician exam room, and in each field office. The plan must be made available to the Assistant Secretary for OSHA and to the Director of the National Institute for Occupational Safety and Health for examination and copying if required.

Employers also must preserve and maintain for each employee an accurate record of occupational exposure. Under the OSHA bloodborne pathogens standard, medical records must include the following information:

- Employee's name and Social Security number;
- Employee's hepatitis B vaccination status including vaccination dates and any medical records relating to the employee's ability to receive vaccinations;

- Results of examinations, medical testing, and postexposure evaluation and followup procedures;
- Health care professional's written opinion; and
- A copy of the information provided to the health care professional.

Medical records must be kept confidential and maintained for at least the duration of employment plus 30 years.

Training records must also be maintained and kept accurate by the employer for 3 years and must include the following:

- Training dates;
- Content or a summary of the training;
- Names and qualifications of trainer(s); and
- Names and job titles of trainees.

Upon request, both medical and training records must be available to the Director of the National Institute for Occupational Safety and Health and to the Assistant Secretary of Labor for Occupational Safety and Health. Training records must be available to employees or employee representatives upon request. The employee or anyone having the employee's written consent can obtain an employee's medical records. In addition, if the employer ceases to do business, medical and training records must be transferred to the successor employer. If there is no successor employer, the employer must notify the Director, NIOSH, U.S. Department of Health and Human Services, for specific directions regarding disposition of the records at least 3 months before intended disposal.

B.8 Schedule and Methods for Implementing Sections of the Standard Covering the Methods of Compliance

Procedures for compliance with OSHA bloodborne pathogen recommendations are included in initial NHANES training programs and incorporated into all specific component procedures and operations procedures in the MEC. All procedures should be operational at the time of training and during the main study.

B.9 Sharps Injury Log

29 CFR Part 1904 – Recording and Reporting Occupational Injuries and Illnesses requires establishment and maintenance of a sharps injury log. All work-related needlestick injuries and cuts from sharp objects that are contaminated with another person’s blood or other potentially infectious material must be entered on the OSHA’s Forms 300 and 301 as an injury. The OSHA’s Forms 300 and 301 serve as the sharps injury log. Do not enter the employee’s name to maintain confidentiality. The sharps injury log must contain, at a minimum:

1. The type and brand of device involved in the incident;
2. The department or work area where the exposure incident occurred; and
3. An explanation of how the incident occurred.

The sharps injury log is maintained for the period required by 29 CFR 1904.03; the OSHA’s Forms 300 and 301 are maintained for five (5) years following the end of the calendar year that these records cover.

B.10 Needlestick and other Sharps Injuries

In January 2001, the Occupational Safety and Health Administration revised the Bloodborne Pathogens (BBP) standard in conformance with the requirements of the Needlestick Safety and Prevention Act. The revisions to OSHA's BBP standard required under the Needlestick Safety and Prevention Act can be broadly categorized into four areas: (1) modification of definitions relating to engineering controls; (2) revision and updating of the Exposure Control Plan; (3) solicitation of employee input; and (4) recordkeeping.

The standard has been revised to add new requirements to the annual review and update of the Exposure Control Plan. Consideration and implementation of safer medical devices must be documented in the Exposure Control Plan by describing the safer devices identified as candidates for adoption, the method or methods used to evaluate devices and the results of evaluations, and justification for selection decisions. The revised standard requires that solicitation of input from employees be documented in the Exposure Control Plan. This information must be updated at least annually. The recordkeeping requirements of the standard have been amended by adding a

paragraph to require that employers maintain a sharps injury log to serve as a tool for identifying high risk areas and evaluating devices.

In November 1999, NIOSH published ALERT, Preventing Needlestick Injuries in Health Care Settings. A comprehensive plan and program to prevent transmission of bloodborne pathogens and to meet (and exceed, whenever possible) regulations was implemented to identify and evaluate various new safer needle technologies and devices. The intent was to replace the existing nonshielded blood collection needles.

Annual formal evaluations have been conducted since 2000. A notebook detailing each evaluation is kept at the Westat home office and is available for review and inspection.

**Attachment A
SAFETY BLOOD COLLECTION SET
Evaluation Form – Stands 245 and 246
Page 1**

Your Name _____
 Today's Date _____
 Product Name _____
 Product Needle Size _____

Key Performance Issues	Yes/ True	No/ False	Don't Know/ Not Applicable		
			50%	25%	0%
1. The product is satisfactory for standard phlebotomy purposes					
2. The product is equally satisfactory for different or diverse patient populations (adults, children, heavy, thin, etc.) Comment:					
3. What percentage of typical clinical procedures does this product address?	100%	75%	50%	25%	0%
4. The product is satisfactory for SPs with fragile veins					
5. The product is simple to operate					
6. The use of this product requires no training					
7. The safety feature activated with a one-handed technique					
8. The safety feature worked reliably					
9. Both hands remain behind the needle during engagement of safety feature					
10. The safety feature did not interfere with the blood draw					
11. This product allowed me to see what I needed to see during the blood draw					
12. The safety feature could not be bypassed					
13. The use of this product did not create any extra risk of sprays, blood leakage, and/or drips					
14. The product could be disposed of into the sharps container that is available for my use					
Feedback					

15. About how many times did you use the blood collection set before you were comfortable using it? (check one)
- 1 time
 5 times
 10 times
 15 times
 20 times
 I never felt comfortable
16. Did you have any problems with this device? Yes No
 If yes, please briefly explain below.

Feedback (continued)

17. Which device would you rather use: (Please check one)

1. The product we normally use

2. This test one

3. Other, please indicate

Comments: _____

**ATTACHMENT B
SHARPS DISPOSAL
Evaluation Form**

Date: _____ Name: _____
 Position: _____ Stand: _____
 Manufacturer: _____ Capacity: _____

Indicate the degree to which you agree or disagree with each statement by circling the most appropriate number for each statement.

Not applicable (N/A) may be used if the question does not apply to this product.

Please Rate:	agree	disagree
1. The container is puncture resistant	1 2 3 4 5	N/A
2. The container does not leak	1 2 3 4 5	N/A
3. The container is stable	1 2 3 4 5	N/A
4. The container is accessible from any direction	1 2 3 4 5	N/A
5. The container is located where the needles are used	1 2 3 4 5	N/A
6. The container allows single handed use	1 2 3 4 5	N/A
7. It is possible to drop sharps or tubes into the container vertically	1 2 3 4 5	N/A
8. No force is required to put sharps or tubes into the container	1 2 3 4 5	N/A
9. Needles/tubing do not get caught on the opening or interior shape	1 2 3 4 5	N/A
10. The container opens and closes easily	1 2 3 4 5	N/A
11. The container has a solid tight-fitting cover	1 2 3 4 5	N/A
12. The box accommodates a range of sharp sizes or tubes	1 2 3 4 5	N/A
13. The size of the container is appropriate for its use	1 2 3 4 5	N/A
14. No one (including a child) can access the contents	1 2 3 4 5	N/A
15. There is a permanent lock for final disposal that is not reversible	1 2 3 4 5	N/A
16. The user can determine the fill level visually	1 2 3 4 5	N/A
17. The container is appropriately labeled	1 2 3 4 5	N/A
18. The box is not threatening to participants	1 2 3 4 5	N/A
19. Use of this container does not compromise infection control practices	1 2 3 4 5	N/A

Did this sharps container interfere with your ability to complete the venipuncture or blood processing protocol? Yes or No

Are there other questions that you feel should be asked regarding the safety/utility of this product?

B.11 Laboratory and Phlebotomy Infection Control

This section contains a summary of all procedures used for infection control in the MEC laboratory and phlebotomy components. For detailed information regarding these procedures, refer to the component's manual of operation.

B.11.1 Glossary

Decontamination:	The use of physical or chemical means to remove, inactivate, or destroy bloodborne pathogens on a surface or item to the point where they are no longer capable of transmitting infectious particles and the surface or item is rendered safe for handling, use, or disposal.
Detergent:	A cleansing agent used to facilitate the removal of gross debris from an object.
Disinfect:	Inactivation of virtually all recognized pathogenic microorganisms but not necessarily all microbial forms (e.g., bacterial endospores) on inanimate objects.
Engineering Controls:	Controls (e.g., sharps disposal containers, self-sheathing needles, safer medical devices, such as sharps with engineered sharps injury protections and needleless systems) that isolate or remove the bloodborne pathogens hazard from the workplace.
Mucous membrane exposure:	Exposure that occurs from droplet contamination (splashes, spatters) of the eyes, nose, or mouth.
Parenteral exposure:	Exposure that occurs from piercing mucous membranes or the skin barrier through such events as needlesticks, human bites, cuts, and abrasions.
Personal Protective Equipment:	Specialized clothing or equipment worn by an employee for protection against a hazard. General work clothes (e.g., uniforms, pants, shirts or blouses) not intended to function as protection against a hazard are not considered personal protective equipment.

Regulated Waste:	Liquid or semiliquid blood or other potentially infectious materials; contaminated items that would release blood or other potentially infectious materials in a liquid or semiliquid state if compressed; items that are caked with dried blood or other potentially infectious materials and are capable of releasing these materials during handling; contaminated sharps; and pathological and microbiological wastes containing blood or other potentially infectious materials.
Sharps with engineered sharps injury protections:	Non-needle sharps or a needle device used for withdrawing body fluids, accessing a vein or artery, or administering medications or other fluids, with a built-in safety feature or mechanism that effectively reduces the risk of an exposure incident.
Sterilize:	The use of a physical or chemical procedure to destroy all microbial life including highly resistant bacterial endospores.
Universal precautions:	An approach to infection control. According to the concept of Universal Precautions, all human blood and certain human body fluids are treated as if known to be infectious for HIV, HBV, and other bloodborne pathogens.
Work Practice Controls:	Controls that reduce the likelihood of exposure by altering the manner in which a task is performed (e.g., prohibiting recapping of needles by a two-handed technique).

In order to comply with Federal regulations, minimize the spread of infectious diseases, and provide a safe working environment, follow defined safety procedures at all times.

B.11.2 Laboratory Access

- Unauthorized people should not enter the MEC laboratory.
- All authorized persons must wear gloves when working with equipment, and when handling biological specimens such as blood, blood products, or urine in the laboratory. Examples are lab staff, biomedical engineers, Coulter technical representatives, NCHS or observers, coordinator, assistant coordinator, health techs, and MEC manager. People who visit the lab to observe should not touch countertops, equipment, or supplies if they are not wearing gloves.

B.11.3 Laboratory/Phlebotomy - Universal Precautions

A complete description of Universal Precautions is described in Section B.3.2. Laboratory staff, including the phlebotomist, observe Universal Precautions at all times.

B.11.4 Laboratory/Phlebotomy - Specific Engineering and Work Practice Controls

Engineering and work practice controls are described in Section B.3.3. Engineering controls eliminate hazards at their source. The biological safety cabinet and waste containers for sharps are examples of engineering controls used in the NHANES. A laminar flow biological safety cabinet is located in the laboratory in every MEC.

All health care workers take precautions to prevent injuries caused by needles and other sharp instruments or devices during procedures, when cleaning used instruments, during disposal of used needles, and when handling sharp instruments after procedures. It is mandatory and essential to use the shielded mechanism of the needle.

Specific measures of protection for the laboratory staff (including the phlebotomist) are described below.

Hang outside street clothing in a designated separate clean area.

Work Practice Controls

- Do not eat, drink, smoke, handle contact lenses, or apply cosmetics or lip balm in the MEC laboratory or in the examination rooms.
- Do not keep food or drinks in refrigerators, freezers, shelves, cabinets, or work surfaces in the examination rooms. An employee lounge with a refrigerator is provided for personal food storage.
- Do not mouth pipette.
- Procedures involving blood or other potentially infectious materials are performed in such a manner as to minimize splashing, spraying, or aerosolizing. For example, the splattering of blood or serum that occurs when rubber stoppers are pulled out of

specimen tubes is minimized by covering the stopper with gauze before removing it and performing this procedure under the biosafety hood.

- Perform all blood processing tasks in the LSBSC.
- Use Aerosolve containers when centrifuging blood tubes.
- Used needles must never be sheared, bent, clipped, broken, or recapped by hand. Discarded needles and other waste sharps must be placed in an “approved” sharps container. Use either a one-handed “scoop” technique or a mechanical device designed for holding the needle sheath.
- Use of the safety shielding mechanism on the blood collection needle is mandatory.
- Never point (direct) or move the unsheathed tip of a needle toward anyone.
- Always be alert and extremely cautious when handling unsheathed needles.
- Immediately after use, dispose of sharps in sharps containers.
- When discarding contaminated sharps, place them in containers that are closable, puncture-resistant, appropriately labeled or color-coded, and leakproof on the sides and bottom.
- Ensure that sharps containers are easily accessible to personnel and located as close as feasible to the use area.
- Keep sharps containers upright throughout use, replace routinely, close when moved, and do not overfill. Do not overstuff the biohazard waste containers by poking the trash down with another object. Shaking the container back and forth is acceptable.
- Never manually open, empty, or clean contaminated sharps disposable containers.
- Never discard needles directly into a container used for ordinary (“noninfectious”) waste.

B.11.5 Laboratory/Phlebotomy - Personal Protective Equipment

A complete description of personal protective equipment is contained in Section B.3.4.

- Wear impervious lab jackets when performing venipuncture and laboratory procedures. Disposable impervious lab jackets are provided to the medical technologists and phlebotomists.
- Remove protective equipment before leaving the work area and after a garment becomes contaminated.

- Place used protective equipment in appropriately designated areas inside the laboratory and place in designated biohazardous containers when being discarded.
- Discard lab jackets when soiled and at the end of each workweek.
- If the LFBSC is nonfunctional, then wear safety glasses when processing blood. Safety glasses are optional for the phlebotomist but are available onsite.
- Wear appropriate face and eye protection such as a mask with glasses with solid side shields or a chin-length face shield when splashes, sprays, spatters, or droplets of blood or other potentially infectious materials pose a hazard to the eye, nose, or mouth.
- Wear gloves when performing venipuncture, processing blood specimens, processing urine, processing vaginal swabs, and performing hematology testing. Disposable, powder-free hypoallergenic nonlatex powder-free gloves are provided to the medical technologists and phlebotomist.
- Change gloves after each sample person's exam or when visibly soiled with blood and/or body fluids.
- Never wash or decontaminate disposable gloves for reuse.
- Discard utility gloves at the first sign of deterioration.
- Remove gloves before leaving the laboratory or phlebotomy room.

Personal Hygiene – Infection Control

- Wash hands with soap and water after removing gloves, or upon accidental skin contact with blood or body fluids, and before working with the next SP.
- Hand washing sinks are located in the bathrooms in trailers 1 and 4, in the hallways in trailers 1 and 2, in the laboratory, phlebotomy room, and staff lounge in trailer 3, and in the dental exam room in trailer 4. The laboratory and dental sinks include an electronic eye on/off mechanism.
- If using liquid soap for hand washing, replace with fresh product when empty. Do not add liquids to a partially full dispenser.

B.11.6 Laboratory/Phlebotomy - Waste Management

A complete description of the waste management procedures is described in Section B.3.5.

- Discard hazardous waste into appropriate containers. Biohazardous waste containers are labeled and sealed to prevent leakage during handling storage and transport. A hazardous waste company is responsible for the disposal of biohazardous waste from the MEC. Do not overstuff the biohazard waste containers by poking the trash down with another object. Shaking the container back and forth is acceptable.
- Dispose of all potentially infectious materials in a biohazard waste container.
- When discarding glass blood tubes, place them in sharps containers that are closable, puncture-resistant, appropriately labeled or color coded, and leakproof on the sides and bottom.
- Place solid waste from the laboratory in biohazard bags and transport to an area designated to hold these bags. A single bag is adequate if the bag is sturdy (not easily penetrated) and if the waste can be put in the bag without contaminating the outside of the bag; otherwise, double bagging is indicated.
- To minimize the potential risk for accidental transmission of disease or injury, store infectious waste waiting terminal processing in a pre-incineration storage area in the MEC accessible only to personnel involved in the disposal process.
- Place regulated waste in closable and labeled or color-coded containers. When storing, handling, transporting, or shipping, place other regulated waste in containers that prevent leakage.
- Transport closed sharps containers and biohazard bags destined for incineration or steam sterilization to the designated pre-incineration storage.
- Discard all regulated waste according to Federal, state, and local regulations.
- Refer to “infectious waste” in the glossary for any questions about identifying wastes for which special precautions appear prudent.
- Liquid Wastes
 - Pour urine down the sink connected to the sewer before discarding the cup in biohazard container.
 - Pour Coulter waste down the sink connected to a sewer. Add 1 3/4 cups (3.75-mL) undiluted bleach to the 10-gallon waste container and reattach to the instrument.

B.11.7 Laboratory/Phlebotomy - Labeling

In the MEC, labels are affixed to containers of infectious waste, centrifuges, refrigerators, and freezers containing blood or body fluids and containers used to store, transport, or ship blood or body fluids.

A complete description of the OSHA label requirements is provided in Section B.5.

B.11.8 Laboratory/Phlebotomy - Housekeeping

A complete description of OSHA's housekeeping requirements is provided in Section B.3.5.

All housekeeping procedures must be observed and will be monitored by project staff:

- Wash work surfaces and or equipment contaminated with blood or body fluids with detergent and disinfect with a 1:10 dilution of bleach.
- At the end of every examination session, disinfect work surfaces with a 1:10 dilution of bleach.
- Check and decontaminate equipment before servicing and shipping.
- Remove protective coverings used to cover equipment and environmental surface and replace as soon as feasible when overtly contaminated with blood or body fluids during the exam session.
- Inspect and decontaminate all materials intended for reuse on a regular basis and clean and decontaminate immediately upon visible contamination.
- Inspect and decontaminate, on a regular basis, reusable receptacles such as bins, pails, and cans that have the likelihood to become contaminated. When contamination is visible, clean and decontaminate receptacles immediately, or as soon as possible.
- Place other regulated waste in closable and labeled or color-coded containers. When storing, handling, transporting, or shipping, place other regulated waste in containers that prevent leakage.
- Clean and decontaminate all equipment and environmental and work surfaces contaminated with blood or other potentially infectious materials.
- Decontaminate work surfaces with an appropriate disinfectant after completion of procedures, immediately when overtly contaminated, after any spill of blood or other

potentially infectious material, and at the end of the work shift when surfaces have become contaminated since the last cleaning.

- Remove and replace protective coverings such as plastic wrap and aluminum foil when contaminated.
- Clean and disinfect equipment and working surfaces, including keyboard covers, with a 1:10 bleach solution (5-mL bleach to 50-mL tap water) or 1:100 bleach solution (1-mL bleach to 100-mL water) after completion of procedures, when surfaces are overtly contaminated, immediately after any spill of blood or other potentially infectious materials, and at the end of the work shift.
- Remove and replace nonabsorbent paper used to cover equipment and environmental surfaces at the end of the work shift or when they become overtly contaminated.
- Check equipment routinely and decontaminate as necessary before servicing or shipping.
- Decontaminate reusable items contaminated with blood or other potentially infectious materials before washing and/or reprocessing. Routinely check equipment and decontaminate it before servicing and shipping.
- Clean and decontaminate all equipment and work surfaces contaminated with blood or other potentially infectious materials.
- On a regular basis inspect and decontaminate reusable receptacles such as bins, pails, and cans that have a likelihood to become contaminated. When contamination is visible, clean and decontaminate receptacles immediately, or as soon as possible.

B.11.9 Laboratory/Phlebotomy – Cleaning a Blood Spill

If a blood spill occurs, wear gloves and, if needed, a gown and facial protection during the cleanup procedure.

If the spill contains broken glass, use dustpan and broom to collect glass pieces. Dispose of broken glass and contaminated paper towels in sharps containers that are closable, puncture-resistant, appropriately labeled or color coded, and leakproof on the sides and bottom. Disinfect the dustpan and broom with bleach solution. Always use mechanical means such as forceps or a brush and dust pan to pick up contaminated broken glass; never pick up broken glass with hands even if wearing gloves. To minimize aerosol formation, do not drop broken glass into a disposal container but gently place it in the container.

To clean a blood spill, perform the following procedure:

- Wear gloves;
- Cover spill with disposable paper towels;
- Soak paper towels with 10 percent bleach solution;
- Let solution soak for at least 30 seconds;
- Dispose of blood/bleach soaked paper towels in biohazard container;
- Allow area to dry and then remove gloves; and
- Wash hands.

B.12 References

The following references were used to prepare the Exposure Plan:

1. *Occupational Exposure to Bloodborne Pathogens*, U.S. Department of Labor, Occupational Safety and Health Administration. OSHA 3127, 1996 (Revised). Title 29 Code of Federal Regulations, Part 1910.1030. [56 FR 64004, Dec. 06, 1991, as amended at 57 FR 12717, April 13, 1992; 57 FR 29206, July 1, 1992; 61 FR 5507, Feb. 13, 1996; 66 FR 5325 Jan., 18, 2001]
2. *Immunization of Health-Care Workers*, USPHS, CDC,, MMWR 1997;46(No. RR-18).
3. *Updated U.S. Public Health Service Guidelines for the Management of Occupational Exposure to HBV, HCV, and HIV and Recommendations for Postexposure Prophylaxis* (MMWR, June 29, 2001)
4. *Occupational Exposure to Bloodborne Pathogens, Needlestick and other Sharps injuries: Final Rule*, U.S. Department of Labor, Occupational Safety and Health Administration. OSHA, 2000 (Revised).
5. Title 29 Code of Federal Regulations, Part 1904.
6. CDC. Guideline for Hand Hygiene in Health-Care Settings Recommendations of the Healthcare Infection Control Practices Advisory Committee and the HICPAC/SHEA/APIC/IDSA Hand Hygiene Task Force. MMWR 2002;51(RR-16).

Copies of these materials are included in the Appendixes of the *Infection Control Manual*.