



# National Health and Nutrition Examination Survey (NHANES)

## Body Composition Procedures Manual



July 2018

## Table of Contents

<b>Chapter</b>		<b>Page</b>
1	Overview of Body Composition .....	1-1
	1.1 Overview of Dual Energy X-Ray Absorptiometry .....	1-1
	1.2 Risks .....	1-2
	1.3 Personnel.....	1-3
	1.4 Flow of Body Composition.....	1-3
2	Equipment/Supplies/Materials .....	2-1
	2.1 Description of Equipment for DXA .....	2-1
	2.1.1 Hologic Discovery A.....	2-1
	2.1.2 Discovery QDR System Operations.....	2-3
	2.1.3 Supplies .....	2-3
	2.1.4 Radiation Badges .....	2-4
	2.2 Maintenance and Repair of Equipment for DXA .....	2-4
	2.2.1 Maintenance and Repair Reports .....	2-5
	2.3 Calibration of Equipment for DXA.....	2-7
3	Protocol.....	3-1
	3.1 Introduction to the DXA Examination.....	3-1
	3.2 Explanation of the DXA Examination.....	3-1
	3.3 Discovery A Table and Discovery QDR System Operation .....	3-2
	3.3.1 Startup Procedures for Hologic Discovery A Table (Start of Session) .....	3-2
	3.3.2 End of Session Shutdown Procedures for Discovery QDR System.....	3-5
	3.3.3 End of Day Shutdown Procedures for Discovery QDR System.....	3-6
	3.4 Examinee Preparation for the DXA Examination .....	3-7
	3.4.1 Measurement of Weight and Height to Determine Body Mass Index .....	3-7
	3.4.2 Preparing the SP .....	3-9

<b><u>Chapter</u></b>		<b><u>Page</u></b>
3.5	Whole Body DXA Scan .....	3-11
	3.5.1 Selecting an SP .....	3-11
	3.5.2 Selecting the Type of Scan .....	3-12
	3.5.3 Positioning the SP .....	3-13
	3.5.4 Reflection Positioning.....	3-15
	3.5.5 Completing the Scan .....	3-17
	3.5.6 DXA Scan Data .....	3-19
3.6	Proximal Femur Scan .....	3-20
	3.6.1 Selecting the SP.....	3-20
	3.6.2 Selecting the Type of Scan .....	3-20
	3.6.3 Positioning the SP .....	3-22
	3.6.4 Positioning the C-Arm and Aligning the Laser.....	3-23
	3.6.5 Scanning.....	3-25
	3.6.6 Panniculus (Belly Fat Pad).....	3-27
3.7	AP Lumbar Spine Scan .....	3-28
	3.7.1 Selecting the SP.....	3-28
	3.7.2 Selecting the Type of Scan .....	3-28
	3.7.3 Positioning the SP .....	3-30
	3.7.4 Positioning the C-Arm.....	3-31
	3.7.5 Scanning.....	3-32
	3.7.6 DXA Scan Data .....	3-35
4	Data Entry Screens.....	4-1
	4.1 Shared Exclusion Questions.....	4-1
	4.2 Weight/Height Entry Screen .....	4-6
	4.3 Screening and Safety Questions.....	4-8
	4.4 DXA Whole Body Data Capture Screen.....	4-13
	4.5 DXA Proximal Femur Data Capture Screens .....	4-19
	4.6 DXA AP Lumbar Spine Scan Data Capture Screens .....	4-22
	4.7 DXA Component Status.....	4-24
	4.8 Session Pickup List .....	4-28
	4.9 Session Preview Report.....	4-29
	4.10 Room Log .....	4-30
	4.11 Close Exam.....	4-31

<b><u>Chapter</u></b>		<b><u>Page</u></b>
5	Referrals and Report of Findings .....	5-1
5.1	Observation Referrals.....	5-1
5.2	Report of Findings for DXA .....	5-3
5.2.1	Sample Preliminary Report of Findings .....	5-4
6	Quality Control .....	6-1
6.1	Equipment and Room Setup Checks.....	6-1
6.1.1	Daily.....	6-1
6.1.2	Three Times Per Week (1st, 3rd, and 5th days of work week).....	6-2
6.1.3	Weekly .....	6-2
6.1.4	Start of Stand.....	6-2
6.1.5	End of Stand .....	6-3
6.2	Procedures for Completing QC Scans.....	6-3
6.2.1	Hologic Anthropomorphic Spine Phantom (HASP) .....	6-3
6.2.2	Step Phantom .....	6-10
6.2.3	Radiographic Uniformity Test.....	6-13
6.2.4	Slim-Line Whole Body Phantom .....	6-19
6.2.5	Hologic Femur/Hip Phantom (Weekly Scan).....	6-23
6.2.6	Circulating HASP (HSP Q-96) .....	6-27
6.2.7	Circulating Block Phantom (Hologic Block Phantom NH #1) .....	6-27
6.2.8	Hologic Whole Body Phantom #008.....	6-28
6.3	QC Scan Checklists.....	6-30
6.3.1	Instructions for Completing Weekly QC Scan Checklist.....	6-30
6.3.2	Instructions for Completing Start of Stand QC Scan Checklist .....	6-31
6.3.3	Instructions for Accessing Blank QC Checklist Forms .....	6-31

<b><u>Chapter</u></b>		<b><u>Page</u></b>
6.4	Data Entry Screens for QC on Equipment .....	6-32
6.4.1	QC Daily Checks .....	6-33
6.4.2	QC Weekly Checks.....	6-34
6.4.3	QC Start of Stand Checks .....	6-35
6.4.4	QC Yearly Checks .....	6-36
6.4.5	QC End of Stand Checks.....	6-37
6.4.6	Incomplete QC Checks .....	6-37

**Appendix**

A	DXA Scripts .....	A-1
B	Shared/Screening/Safety/Exclusion Questions (Spanish Translation).....	B-1
C	Setup Procedures for Body Composition/DXA Room.....	C-1
D	Start of Stand Discovery QDR System Procedures .....	D-1
E	DXA Bone Densitometer Report.....	E-1
F	Start of Stand QC Scan Checklist.....	F-1
G	Weekly QC Scan Checklist.....	G-1
H	Teardown Procedures and Securing the Discovery System For Travel.....	H-1
I	Power Failure Procedures for DXA .....	I-1
J	Script for Parents .....	J-1

**Table**

1-1	Age groups and gender for body composition.....	1-2
1-2	Pregnancy status information for body composition by age and gender.....	1-2

<b>Figure</b>		<b>Page</b>
2-1	Hologic Densitometer Discovery A .....	2-1
2-2	Discovery A table control panel.....	2-2
2-3	Laser warning label.....	2-2
2-4	Laser locator label.....	2-3
3-1	Hologic Discovery A table showing power indicator .....	3-3
3-2	Discovery A Table instrument control panel .....	3-3
3-3	Scan table pad (top view).....	3-10
3-4	Correctly positioned whole body scan.....	3-14
3-5	Reflection positioning .....	3-16
3-6	Data displayed after analysis (1).....	3-19
3-7	SP positioning for femur scan .....	3-22
3-8	Foot placement against hip scan positioning fixture.....	3-23
3-9	Starting point and reposition mark for femur scan .....	3-24
3-10	Properly aligned and rotated femur scan.....	3-27
3-11	Lumbar spine positioning.....	3-31
3-12	Positioning of lower legs for spine scan.....	3-31
3-13	Positioning for laser indicator for AP spine scan .....	3-32
3-14	Repositioning the spine scan.....	3-34
3-15	Data displayed after analysis (1).....	3-36
3-16	Data displayed after analysis (2).....	3-37
6-1	Spine phantom registration mark.....	6-5

<b><u>Figure</u></b>		<b><u>Page</u></b>
6-2	Spine phantom and laser crosshair position .....	6-5
6-3	Slim-Line whole body phantom fully assembled .....	6-19
6-4	Layout of whole body phantom—top view .....	6-29
6-5	Layout of whole body phantom—side view .....	6-30
 <b><u>Exhibit</u></b>		
3-1	Discovery QDR login screen.....	3-4
3-2	Discovery QDR screen with option of system backup .....	3-5
3-3	Discovery QDR screen main menu.....	3-6
3-4	Exiting the discovery QDR system.....	3-7
3-5	Selecting “perform exam” .....	3-11
3-6	Patient selection screen.....	3-12
3-7	Operator field for initials .....	3-12
3-8	Scan selection screen.....	3-13
3-9	Whole body scan parameters screen.....	3-16
3-10	Whole body scan image .....	3-18
3-11	Exit exam/new scan window box.....	3-18
3-12	Scan selection screen.....	3-20
3-13	Default Scan Mode unchecked.....	3-21
3-14	Left Hip Scan Mode Selection.....	3-21
3-15	Scan Parameters window for proximal femur scan .....	3-22

<b><u>Exhibit</u></b>		<b><u>Page</u></b>
3-16	Hip scan window .....	3-25
3-17	Repositioning the femur .....	3-26
3-18	Scan selection screen .....	3-28
3-19	AP Lumbar Spine Scan Default Scan Mode unchecked .....	3-29
3-20	AP Lumbar Spine Scan Mode Options .....	3-29
3-21	AP Lumbar Spine Scan Parameters screen .....	3-30
3-22	Spine scan window .....	3-33
4-1	Shared exclusion questions .....	4-2
4-2	Exclusion from DXA due to pregnancy status .....	4-3
4-3	Shared exclusion questions without pregnancy question .....	4-4
4-4	Exclusion from DXA due to data effect .....	4-5
4-5	Exam status “not done” due to data effect .....	4-5
4-6	Response options for question “where is the amputation?” .....	4-6
4-7	Weight/height entry screen .....	4-7
4-8	Weight/height information transferred from body measures .....	4-7
4-9	Entering the weight/height information into the screen .....	4-8
4-10	Selection for high-power scan .....	4-8
4-11	Screening questions .....	4-9
4-12	Screening question highlighted with options .....	4-10
4-13	Exclusion from spine scans .....	4-11
4-14	Femur scan exclusion .....	4-11



<b><u>Exhibit</u></b>		<b><u>Page</u></b>
4-15	Scan right hip message .....	4-12
4-16	Scan left hip message .....	4-12
4-17	Whole body data capture (1) .....	4-13
4-18	Whole body data capture with reflection positioning .....	4-14
4-19	DXA data capture (2) .....	4-15
4-20	DXA data capture (comments on scan) .....	4-16
4-21	DXA data capture (scan not completed) .....	4-17
4-22	High-power (HP) message box .....	4-18
4-23	HP error message .....	4-18
4-24	DXA data capture (femur scan) .....	4-19
4-25	DXA data capture (femur scan) Femur Archive file name .....	4-20
4-26	DXA data capture (femur scan) .....	4-21
4-27	DXA data capture (AP spine scan) .....	4-22
4-28	DXA data capture (AP spine scan) AP Spine Archive file name .....	4-23
4-29	DXA data capture (AP spine scan) .....	4-24
4-30	DXA component status (required comments) .....	4-25
4-31	DXA component status .....	4-26
4-32	Session pickup list .....	4-28
4-33	Session preview report .....	4-29
4-34	Room log for body composition .....	4-30

<b><u>Exhibit</u></b>		<b><u>Page</u></b>
5-1	Menu to select observation referral .....	5-1
5-2	Pick list of SPs in current session.....	5-2
5-3	Observation referral in body composition.....	5-2
5-4	Observation referral from other components in physician's referral review box.....	5-3
5-5	Sample report of findings for body composition .....	5-4
6-1	Discovery main menu .....	6-3
6-2	Daily QC setup box.....	6-4
6-3	System self-test.....	6-6
6-4	System test passed .....	6-6
6-5	Auto QC passed.....	6-7
6-6	Spine Phantom QC—plot for bone mineral density (BMD).....	6-8
6-7	Spine phantom QC—plot for bone mineral content (BMC).....	6-9
6-8	Step phantom setup window .....	6-10
6-9	Step phantom scan .....	6-11
6-10	Step phantom evaluation completed successfully.....	6-12
6-11	Step phantom QC completed, press Continue .....	6-12
6-12	Selecting radiographic uniformity from patient list .....	6-13
6-13	Operator box for initials.....	6-14
6-14	Selecting whole body in the select scan type screen.....	6-14
6-15	Radiographic uniformity scan parameters screen .....	6-15

<b><u>Exhibit</u></b>		<b><u>Page</u></b>
6-16	Radiographic uniformity test.....	6-16
6-17	Selecting radiographic uniformity for SD results.....	6-17
6-18	Low air global stats SD.....	6-17
6-19	High air global stats SD.....	6-18
6-20	Selecting slim-line WB phantom scan.....	6-20
6-21	Operator box for initials.....	6-21
6-22	Selecting whole body in the select scan type screen.....	6-21
6-23	Slim-line scan parameters screen.....	6-22
6-24	Selecting Hologic Femur/Hip Phantom from patient menu.....	6-23
6-25	Operator box for initials.....	6-24
6-26	Selecting Right Hip in the scan selection screen.....	6-24
6-27	Right Hip Scan Mode options.....	6-25
6-28	Hologic Femur/Hip Phantom Scan Parameters screen.....	6-25
6-29	Machine scanning Femur/Hip phantom.....	6-26
6-30	Exit exam/new scan window box.....	6-26
6-31	Quality control reminder message box.....	6-32
6-32	Utilities menu to select quality control.....	6-32
6-33	Quality control logon.....	6-33
6-34	Quality control daily checks.....	6-33
6-35	Quality control weekly checks.....	6-34
6-36	Quality control start of stand checks (1).....	6-35

**Contents (continued)**

---

<b><u>Exhibit</u></b>		<b><u>Page</u></b>
6-37	Quality control start of stand checks (2) .....	6-35
6-38	Quality control yearly checks .....	6-36
6-39	Quality control end of stand checks .....	6-37
6-40	Quality control incomplete entry .....	6-38

# Overview of Body Composition

# 1

Body composition and bone health will be evaluated in the current National Health and Nutrition Examination Survey (NHANES) by anthropometry and dual energy X-ray absorptiometry (DXA). These methods will be used to (1) monitor secular trends in overweight prevalence; (2) describe the prevalence of obesity; and (3) examine the relationship between overweight and obesity and other examination measures, including blood pressure, glucose intolerance, and a battery of indicators for cardiovascular disease.

## 1.1 Overview of Dual Energy X-Ray Absorptiometry

Dual energy x-ray absorptiometry (DXA) was included for the first time in the NHANES during NHANES III: 1988–94. Femoral bone mineral density was assessed at that time using pencil-beam bone densitometers (Hologic QDR 1000). In 1999–2006 and 2011–16, the DXA component included acquisition of whole body DXA scans using Hologic QDR 4500A fan-beam bone densitometers. Scans of the proximal femur and anteroposterior (AP) or lumbar spine were collected in 2005–10 and 2013–14.

The NHANES whole body DXA data will be used to examine age, sex, and racial/ethnic differences in body composition (bone mineral, lean soft tissue, and fat mass) during the life cycle to explore the relationship between body composition and behavioral factors such as diet and physical activity and physiologic factors such as hypertension, diabetes, cardiovascular disease, and muscle strength. All individuals 8–59 years are eligible for the whole body scan, with the exception of pregnant females.

The femur and AP lumbar spine scans will provide information on osteoporosis and low bone mass for participants ages 50 years and older.

The DXA Whole Body scan will be completed on all individuals 8 through 59 years (see Table 1-1). The femur and AP spine will be completed on sample persons (SPs) 50 years and older. Pregnancy status will be assessed on all females 12 through 59 years and menstruating 8- to 11-year-olds. If the result of the pregnancy test is positive, the SP will be excluded from the entire exam. If a pregnancy test for an SP who is 8–17 years old comes back positive, a second test will be done for

confirmation. In addition, women aged 12 through 59 years will be asked to self-report their pregnancy status and will be excluded if they respond “Yes” or “Don’t Know,” even if the pregnancy test was negative. Self-report on pregnancy status for 12- to 15-year-old females will be asked in the Physician’s Exam. Females 8 through 11 years of age will not be asked about pregnancy status (see Table 1-2).

**Table 1-1. Age groups and gender for body composition**

Component	Age	Gender
DXA (whole body)	8–59	Males and females
DXA femur	50 +	Males and females
DXA AP spine	50 +	Males and females

**Table 1-2. Pregnancy status information for body composition by age and gender**

Pregnancy status	Age	Gender
Pregnancy status—urine test	12–59 years	Females
Pregnancy status—urine test	Menstruating 8–11 years	Females
Pregnancy status—self report	12–59 years	Females
Pregnancy status—self report (Asked in Physician’s Exam)	12–15 years	Females
Pregnancy status—self report (Shared Exclusion Question)	18–59 years	Females

## 1.2 Risks

The risk from DXA scans is low. The average effective dose to an individual in the United States from background radiation is approximately 3600 microsieverts ( $\mu\text{Sv}$ ) per year. A standard diagnostic x-ray of the spine, for example, delivers an effective radiation dose of 1100  $\mu\text{Sv}$ .

The total estimated effective radiation dosage in  $\mu\text{Sv}$  by age:

- 8–59 years: 4.2 to 5.2 for whole body scans;
- 50–59 years: 15.6 for whole body, femur, and AP lumbar spine; and
- 60+ years: 11.4 for femur and AP lumbar spine.

## 1.3 Personnel

A certified radiology technologist will conduct all DXA scans.

## 1.4 Flow of Body Composition

The body composition exam will begin with the whole body DXA scan, followed by the femur scan, and the AP spine scan. Participants will receive one or more scans, with a **maximum** of three DXA scans. Under no circumstances should a whole body scan be repeated. If a problem occurs during any of the scans, it should be documented in the Integrated Survey Information System (ISIS) Data Capture screen and/or an Unusual Field Occurrence (UFO) if necessary.

### 2.1 Description of Equipment for DXA

#### 2.1.1 Hologic Discovery A

The Hologic Discovery A (Figure 2-1) is a fan beam x-ray bone densitometer, which uses two different energy levels produced by an energy tube to estimate bone mineral content (BMC) and bone mineral density (BMD). The Discovery A uses a low level of x-rays, and under standard operating conditions, the entrance dose to the examinee for a whole body scan is less than 1 mR<sup>1</sup> (a standard x-ray is approximately 35 mR).

**Figure 2-1.** Hologic Densitometer Discovery A



The densitometer produces ionizing radiation in the form of x-rays and uses laser radiation to position scans, although the radiation exposure is so low that no shielding of the room or of health technologists is required.

The x-ray ON indicator is an amber light located in the upper right corner of the instrument control panel (see Figure 2-2). When the x-ray lamp is lit, x-rays are being produced.

---

<sup>1</sup> One mR is a milliroentgen, or one-thousandth of a roentgen, the measurement of energy produced by Gamma or x-ray radiation in a cubic centimeter of air.



The **Emergency Stop Button** is a round red button at the right end of the Discovery A table control panel that is used for emergencies. When this button is pressed, the X-rays and the table are disabled and scanning stops immediately. Pulling on the button resumes normal operation.

1. **Press down** on the button to **stop** the scan.
2. **Pull up** on the button to **resume normal operation**.

Figure 2-2. Discovery A table control panel

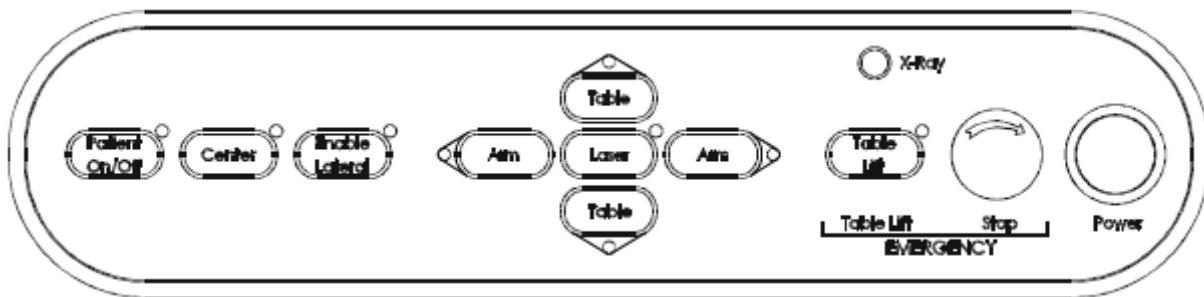

**Laser positioning.** The Laser-On Lamp is an amber light above the laser switch on the Discovery A table control panel. It alerts the user that the laser position indicator is active. The laser position indicator unit produces 1 mW laser emission. The examinee and technologist should avoid looking directly into the beam or placing reflective objects in the path of the beam.

The Discovery A table includes a laser safety feature that turns the laser off if the distance between the top (right side) of the table is less than approximately 15.5 inches from the laser light spot. This feature is there to help prevent shining the laser light in the examinee's eyes. Figure 2-3 shows the laser warning label located on the scanner arm.

Figure 2-3. Laser warning label

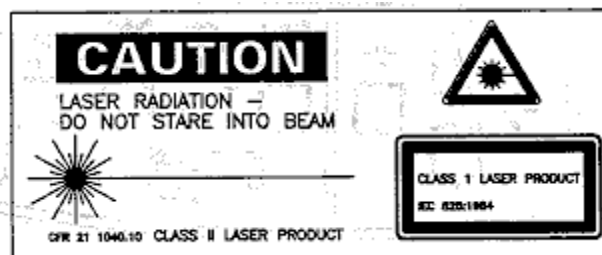

Arrows marked “Laser Aperture” mounted on the scanner arm note the location of the laser beam. Figure 2-4 shows the laser locator label.

**Figure 2-4. Laser locator label**

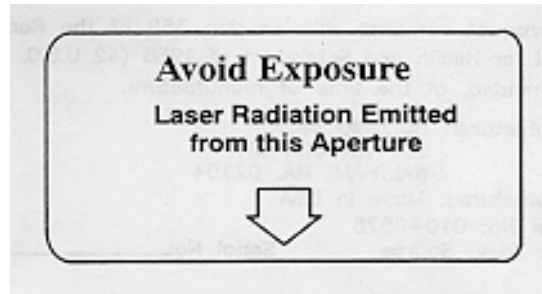

### 2.1.2 Discovery QDR System Operations

See Section 3.3 in Chapter 3 for Startup and Shutdown Procedures for the Discovery QDR System. See Appendix I for Power Failure Procedures.

### 2.1.3 Supplies

- Disposable exam paper is used for all sample persons (SPs). A clean layer of the paper is placed on the exam table between each SP.
- A Velcro strap is used to prevent movement of the feet during the whole body scan. This is tied around the SP's ankles with his or her toes pointing up.
- A radiolucent contour pillow can be used to support the head for SPs who have trouble lying flat due to back problems or difficulty breathing.
- Foam wedges can also be used to support the head, or they may be placed under the knees for SPs having difficulty lying flat.
- Foam sponges may be used to separate the hands from the torso during the whole body scan, or between the feet to prevent any overlapping.
- A plexiglass ankle positioning tool is used to assist in positioning the leg for the femur scan.
- A large cube positioning tool is used to assist in positioning for the spine scan.

### 2.1.4 Radiation Badges

Health technologists operating the densitometers are required to wear radiation badges for densitometry processing. A badge specific for each mobile examination center (MEC) is placed in the room on the computer cart beside the densitometer. A control badge for each team is kept in a radiation free-area on the MEC, such as the staff lounge. This control badge travels with the team to each stand.

## 2.2 Maintenance and Repair of Equipment for DXA

If the component lead health technologist (CLHT) needs to contact Hologic for repair, notify the MEC manager and the home office of the problem. Be sure to document the call in the Hologic Call Log. The Hologic contact number and other important information are listed below:

- Call Hologic customer support at 1-800-321-4659.
- Provide the model number and the serial number for your machine.
  - Model number for all MECs is Discovery A.
  - Serial number for MEC 1 = 85257.
  - Serial number for MEC 2 = 85286.
  - Serial number for MEC 3 = 85148.
- Provide the location of the MEC at the time the service will be needed.
  - Confirm with the Hologic person making the reservation and with the Hologic Service Technician the location of the MEC. They often confuse this with the last place the MEC was when it was serviced.

## 2.2.1 Maintenance and Repair Reports

When the Hologic densitometer is serviced or repaired, it is the responsibility of the CLHT to confirm that all required reports are completed, stored, and sent to the appropriate people. These reports include the following:

### 2.2.1.1 Regular Reports:

#### 1. Field Service Report (FSR):

When the Hologic densitometer is serviced or repaired:

- The Hologic service technician will complete an FSR and will send the FSR to the Facilities and Equipment Specialist (FES) or CLHT.
- The FES will email the FSR to the home office project person and copy the CLHT and MEC Manager.
- The CLHT will confirm that the FSR was sent to the home office project person and put a copy of the FSR in the service report binder kept in the DXA room.

#### 2. DXA Bone Densitometer Report (BDR):

When the Hologic densitometer is serviced or repaired, the CLHT will do the following:

- Complete a “DXA Bone Densitometer Report (BDR)”;
- Scan and send an electronic copy of the DXA BDR to the home office, which will send this report to NCHS and the Quality Control Reading Laboratory; and
- Place a copy of the DXA BDR in the service report binder kept in the DXA room.

Blank DXA BDR forms are stored electronically in the Integrated Survey Information System (ISIS) system. Open Word, select File/Open, and look in the directory for Mecstaff/Blank forms/DXA\_serv.doc.

#### 3. Hologic Customer Service Log (Call Log):

When the Hologic densitometer is serviced or repaired, the CLHT will do the following:

- Enter the date, description of the problem, the solution, and the CHLT’s initials for each call made for problems with the densitometer.

- At the end of the stand, scan and send an **electronic copy** of the Call Log to the home office, which will send it to NCHS and the Quality Control Reading Laboratory.

### 2.2.1.2 Preventative Maintenance Reports:

Preventative Maintenance (PM) will be completed on each of the densitometers twice a year.

The first Preventative Maintenance of the year will be completed **prior to the first stand of the year** for each of the mobile examination center (MECs) (January/February). This will require coordination between the FES and CLHT on the MEC where the Preventative Maintenance is to be completed. Because this Preventative Maintenance will be completed prior to the setup at that stand, this means the CLHT will be scheduling a Preventative Maintenance for a location where the survey will be going next. The CLHT will have to get the information for that MEC. **It is the responsibility of the CLHT to follow up with the FES and Hologic service technician to confirm that the PM is scheduled and completed prior to setup.** See Section 2.2 for the information needed to contact Hologic for the Preventative Maintenance.

The second Preventative Maintenance of the year will be completed approximately 6 months following the previous one (July/August). The Preventative Maintenance will be scheduled prior to setup and will also require coordination between the FES and CLHT on the MEC where it is to be completed. The coordination, responsibility, and followup are the same as for the first Preventative Maintenance.

The reports associated with Preventative Maintenance include the following:

#### 1. Field Service Report (FSR):

The FSR for the Preventative Maintenance is the same form used for regular service. Note that if you have to schedule a service for another problem with the machine, the Hologic service technician will complete two separate FSRs, one for the Preventative Maintenance and one for the issue with the machine or software.

#### 2. Preventative Maintenance Checklist (PMC):

When the Preventative Maintenance service is completed by the Hologic service technician:

- The **Hologic service technician** will complete the PMC and email it to the FES;

- The **FES** will email the PMC to the home office project person and copy the CLHT and MEC Manager; and
- The CLHT will confirm that the PMC was sent to the home office project person and put a copy of the PMC in the service report binder kept in the DXA room.

### 3. Radiation Measurement Report (RMR):

When the Preventative Maintenance service is completed by the Hologic service technician:

- The **Hologic service technician** will complete the RMR and email it to the FES;
- The **FES** will email the RMR to the home office project person and copy the CLHT and MEC Manager; and
- The CLHT will confirm that the RMR was sent to the home office project person and put a copy of the RMR in the service report binder kept in the DXA room.

## 2.3 Calibration of Equipment for DXA

Refer to Chapter 6 for complete instructions regarding calibration and quality control scanning procedures.

### 3.1 Introduction to the DXA Examination

The technologist should briefly explain the examination when the sample person (SP) is brought into the room. The exam should be explained in more detail as it is being conducted. The objective is to inform the SP about the exam and to position the SP as quickly as possible. Below is a suggested introductory script, but the examiner should use his or her own words for this explanation. This is an explanation, not a standard script, so the technologist may adjust the explanation to the level of understanding of the examinee.

**Suggested introduction to component (English version):**

“In this room, we are going to be doing one or more scans of your body that will tell us how strong your bones are and how much body fat you have. I will explain in more detail as I do the exam. Please have a seat up here on the table and get as comfortable as possible. I am going to ask you a few questions before I start the exam.”

### 3.2 Explanation of the DXA Examination

The technologist is scanning the ID wristband of the examinee during the explanation of the exam. The explanation should be used as a guideline only and the technologist should adjust the explanation to the level of understanding of the SP. The script used for an 8-year-old will be different from the script used for a 59-year-old. The scripts below provide suggested explanations of the body composition and the DXA exams.

**Suggested explanation of whole body DXA scan (English version):**

“For this examination, I will be doing a scan of your body with this machine. It will tell us how much body fat you have. Now please lie down on the table and I will position you for the scan. I’m going to pull up on your shoulders to straighten you. I will position your arms and feet correctly for the scan and then wrap these Velcro straps loosely around your ankles to hold them in place. The scan will take about 3 minutes to complete and you will not feel anything except for the table movement. As the machine scans your body, the table will move up and down and back and forth. This overhead arm (the C-arm) will also be moving. In order to

receive a good quality scan, it is important that you lie perfectly still during the scan and do not talk.”

**Suggested explanation of femur scan (English version):**

“This scan will be of your hip; it will tell us how strong your bones are. For this scan, please continue to lie still with your legs flat against the table. I will rotate your left leg inward slightly and then keep it in place using this foot brace. Please place your arms across your chest. You will not feel anything during the scan. Please be as still as possible and do not talk during the scan.”

**Suggested explanation of AP lumbar spine scan (English version):**

“These spine scans will also tell us how strong your bones are. For these spine scans, you will lie flat on the table. I’m going to place a pillow under your head. Then I am going to bend your legs at a 90° angle at the hip and knee by placing them on this large, soft, cube-shaped pillow. You will not feel anything during this scan. Please be as still as possible and do not talk during the scan. For the last two scans I will need you to place your arms over your head and hold your breath for 10 seconds.”

**Suggested explanation after completion of scans (English version):**

“Please stay lying down until I have moved the overheard arm out of the way. Now you can sit up. You will receive the results in the mail in 12-16 weeks. Let’s find out where you go next.”

## 3.3 Discovery A Table and Discovery QDR System Operation

The Discovery QDR system should be turned on at the beginning of the day and off at the end of each session for that day. See Appendix C for setting up the Discovery A table for operations. Routine Discovery QDR system startup procedures for the beginning of a session are outlined below in Section 3.3.1. See Appendix H for securing the Discovery A table for travel. Routine shutdown procedures are outlined in Section 3.3.2. See Appendix I for power failure procedures for DXA.

### 3.3.1 Startup Procedures for Hologic Discovery A Table (Start of Session)

Confirm these settings first.

- Verify that the green indicator on the back of the left pedestal is on. (This light indicates that the system is receiving AC power.) This should be left on at all times unless a



power failure occurs. See Figure 3-1 below. If the green light is not on, check and see if the UPS (uninterruptible power supply) is plugged into the outlet; if not, plug it in and then make sure the circuit breaker switch is in the on (1) position. If the green indicator does not light up, notify the Facilities and Equipment Specialist (FES).

- On the control panel, the POWER green indicator light should be on. If not, press the POWER button to turn it on. See Figure 3-2.
- The Hologic COMPUTER POWER switch located underneath the workstation should be ON. (This is left ON to allow network backup overnight.)

Figure 3-1. Hologic Discovery A table showing power indicator

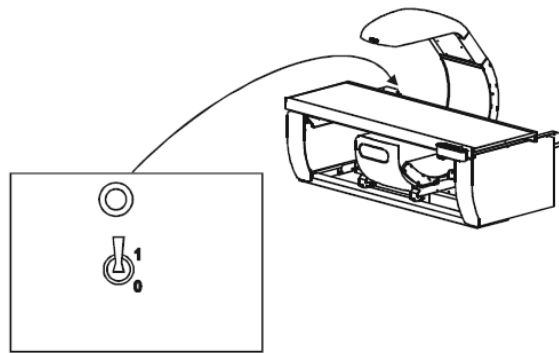

Description	Function
Circuit Breaker	Turns the power to the Discovery system off (0) and on (1).
Indicator	Glows green when the circuit breaker is in the on (1) position.

Figure 3-2. Discovery A Table instrument control panel

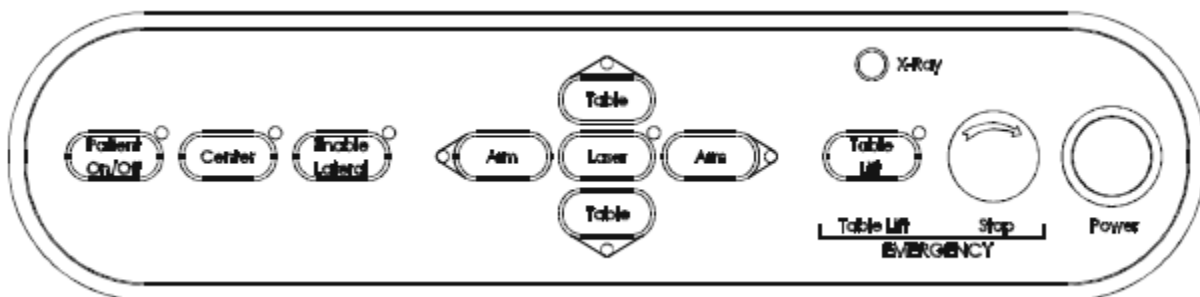

Turning the Hologic Discovery QDR System ON (Start of Session Routine Procedure):

- When the Discovery QDR system login screen is displayed, double-click on QDR (soccer ball icon). See Exhibit 3-1. If the QDR database has not been backed up, a dialog Windows box will appear: “A backup of your QDR system’s database has not been performed in # days! Do you want to perform a system backup now?” Click “No.” See Exhibit 3-2.
- The X-ray table will turn on and the Discovery QDR Main Menu will be displayed (see Exhibit 3-3).
- Log in to the Integrated Survey Information System (ISIS). A message will be displayed: “Drive P successfully mapped.” Exit and do not save this file.

**NOTE:** DO NOT log on to ISIS until the startup for the Hologic computer has been completed. If the ISIS computer is opened before the Hologic computer, a message will be displayed after the scan is completed: “Unable to find drive specified.” If you get this message, call the ISIS Help Line.

Open the DXA/Body Composition application on the ISIS screen.

**Exhibit 3-1. Discovery QDR login screen**

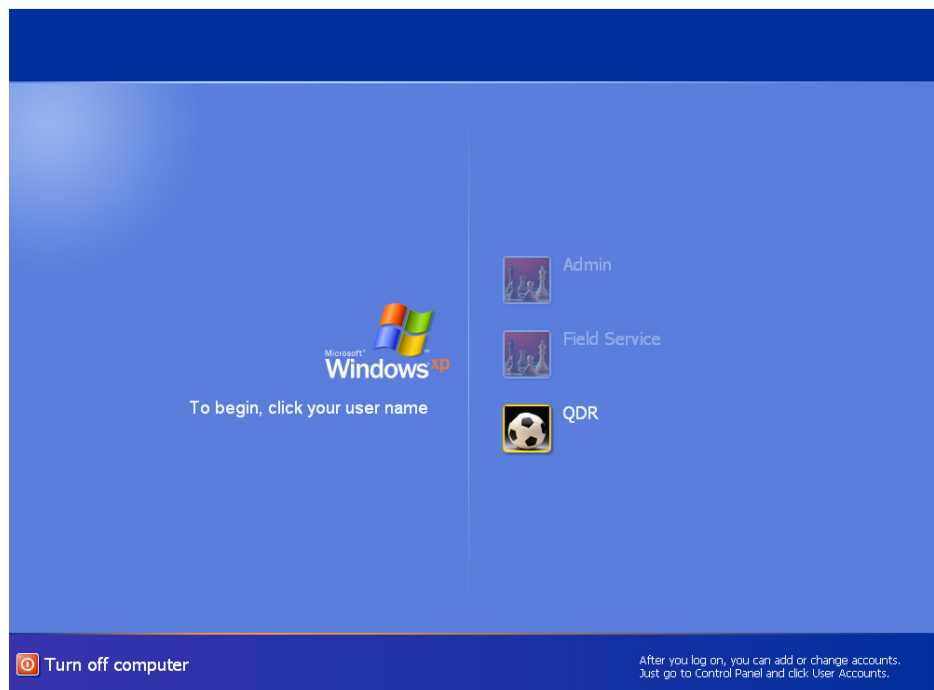
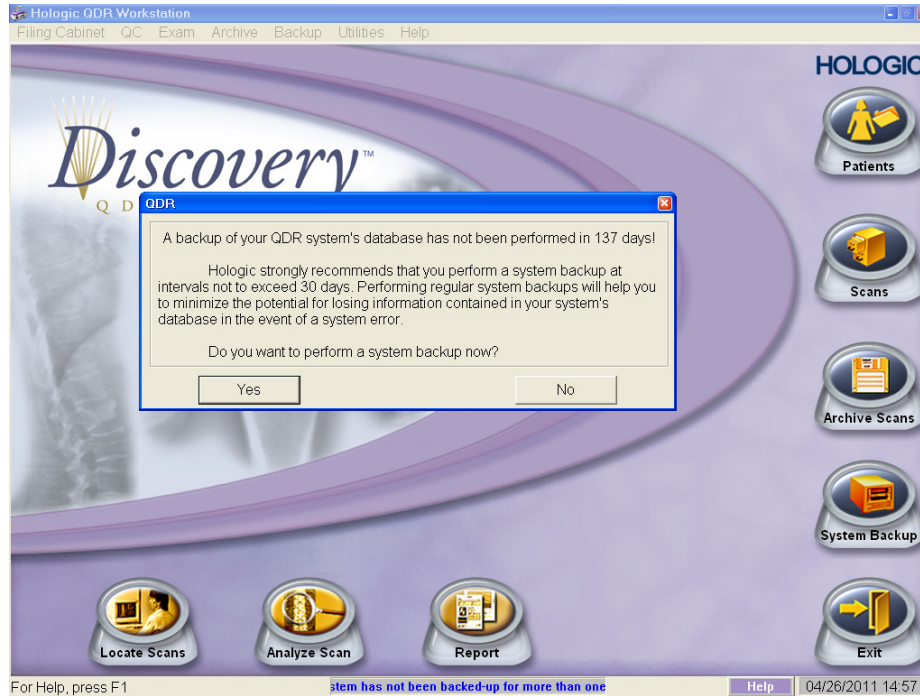

Exhibit 3-2. Discovery QDR screen with option of system backup



### 3.3.2 End of Session Shutdown Procedures for Discovery QDR System

Close the DXA/Body Composition application. The screen should display the Discovery QDR Main Menu. (See Exhibit 3-3.)

**Exhibit 3-3. Discovery QDR screen main menu**

### 3.3.3 End of Day Shutdown Procedures for Discovery QDR System

- Click Exit (bottom right corner). Then select “Exit QDR without Shutdown” and click OK. See Exhibit 3-4. Leave the monitor at blue screen. The Hologic computer should always be kept on through the duration of the stand.
- Reboot ISIS.

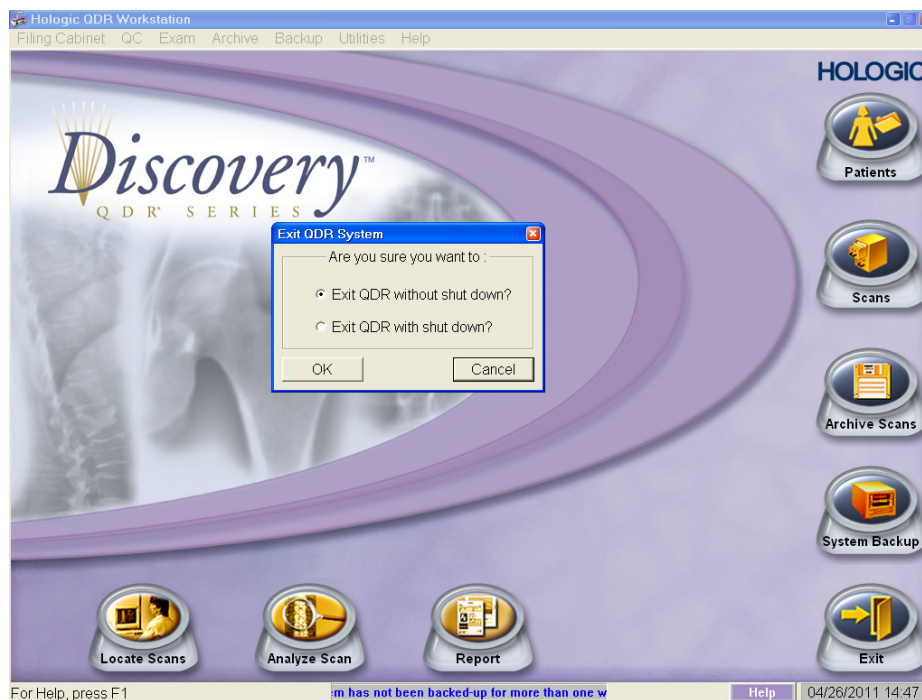
**Exhibit 3-4. Exiting the discovery QDR system**

## 3.4 Examinee Preparation for the DXA Examination

The sample person (SP) should be logged into ISIS as soon as possible after he or she has entered the room.

### 3.4.1 Measurement of Weight and Height to Determine Body Mass Index

After answering the Shared Exclusion Questions, the next screen displayed will be the weight/height data entry screen. See Exhibit 4-8 in Chapter 4. If the SP was in the anthropometry (body measures) component prior to this test, the weight and height will already be uploaded and displayed on the ISIS screen, along with the component it transferred from (e.g., body measures). See Exhibit 4-9 in Chapter 4. If the information is not displayed, you will need to measure the SP's weight and height using the floor scale and stadiometer in the room. The system will use the weight and height measurements to calculate the body mass index, which will determine whether the SP needs the high-power whole body scan or not. The same precision to take the weight and height measurements in the anthropometry component must be used in this component.

### 3.4.1.1 Weight

Follow these steps to take the SP's weight:

1. Make sure the scale weight is in kilograms by checking the switch on the underside of the digital display.
2. Place the scale on the floor.
3. Switch on the scale by gently pressing the blue ON button. Have the SP remove his or her shoes and any outer clothing such as sweaters, jackets, etc.
4. Wait until the display 0.0 kg and the Ready/Complete symbol O appear on the digital display. Have the SP step on the scale with his or her feet positioned in the center.
5. Ask the SP to stand straight and remain still.
6. The scale will display “----” while it is taking the SP's measurement. Record the weight in kilograms in the weight field.
7. Ask the SP to step off the scale. The scale switches off automatically after 45 seconds of inactivity.

If the SP's weight is more than 450 pounds, he or she will be excluded from the entire body composition component due to the weight limitation of the table. If the SP is greater than 450 pounds after weighing, the application will still ask you to obtain the height. After you enter the height, the SP will be excluded from the exam, and the exam status will be set to “Not Done” due to “weight limitation on equipment.”

### 3.4.1.2 Height

Follow these steps to take the SP's height:

1. Ask the SP to remove his or her shoes if necessary.
2. Place the stadiometer a few inches away from the wall. Check to be sure the measurement column on the stadiometer is completely inserted into the floor piece. Pull the sliding top bar section up and open the head piece to allow the SP to step under the head piece.
3. Ask the SP to stand erect on the floorboard with his or her back to the vertical piece of the stadiometer and the wall. The SP should not be leaning against the stadiometer.

4. Ask the SP to evenly distribute weight on both feet. The heels are placed together with the feet pointed slightly outward at a 60° angle. The arms hang freely, by the sides of the trunk, with palms facing the thighs.
5. Position the head in the Frankfort horizontal plane. The head is in the Frankfort plane when the horizontal line from the ear canal to the lower border of the orbit of the eye is parallel to the floor and perpendicular to the vertical backboard. Many people will assume this position naturally, but for some it may be necessary to make a minor adjustment. If required, gently tilt the head up or down until proper alignment is achieved with the eyes looking straight ahead. Lower the headpiece snugly to the crown of the head with sufficient pressure to compress the hair. Once correctly positioned, ask the SP to inhale deeply and to stand fully erect without altering the position of the heels.
6. Hold the top sliding bar in place at the junction and ask the SP to step out away from the stadiometer.
7. Record the measurement in centimeters (measurements printed on right side of bar) at the orange line on the measuring bar.

If the SP is greater than 6'5", he or she will be excluded from the whole body scan due to limitations of the table. The exam status will be set to "Not Done" with the comment "Exceeds height limitation."

### **3.4.1.3 Body Mass Index**

After entering the SP's weight and height, the ISIS application will calculate the body mass index (BMI) for the SP. If the SP is a male with a BMI  $\geq 31$ , or a female with a BMI  $\geq 32$ , they will be selected for the high power option. A pop-up message will come up stating, "This SP has been selected for the HP Whole Body Scan." Be sure to select this scan under the scan type in the Hologic Discovery QDR system. The high-power whole body scan will be performed only on SPs 18 years or older.

## **3.4.2 Preparing the SP**

The next screen will have the screening and safety exclusion questions. Go through the questions with the SP, and then have him or her remove all metal objects from his or her body (jewelry, belts, snaps, underwire bras). If the SP has small objects such as rings that will not come off, mark "No" in the screening questions and proceed with the exam. (Inability or refusal to remove jewelry is not

exclusion for DXA; however, the SP should be encouraged to remove all metal objects if possible.) False teeth and hearing aids do not have to be removed. If a female SP needs to remove her bra for the scan, pause the exam and escort her to the nearest restroom at this time.

Before moving the table or C-arm:

- Confirm that the runner area of the table is clear of objects that might interfere with table movement; and
- Check that the table scan area is clear of articles that might interfere with table movement.

Press the left arm switch on the Discovery A table Control Panel to allow the C-arm to move to the far left and extend the table out from the base. See Figure 3-2 earlier in this chapter. This will make it easier for the SP to get on (or off) the table.

- After the C-arm and table stop moving, have the SP lie down on his or her back with his or her head to your right as you face the table. Press the “Center” switch on the Control Panel, and wait for the C-arm to position itself to the center of the table.
- Make sure that the SP’s body is entirely within the scan limit borders on the pad, especially the SP’s head (see Figure 3-3.)

**Figure 3-3. Scan table pad (top view)**

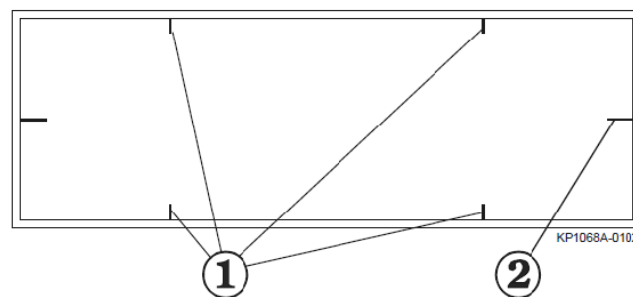

Item	Description	Function
1	Scan Limit border	Indicates the maximum scan range of the unit. Patient positioning must be within this border.
2	Center Lines	Used to center the patient on the table.



## 3.5 Whole Body DXA Scan

Make sure all Shared Exclusion, Screening, and Safety Exclusion Questions in ISIS have been answered and you are up to the Data Capture screen in ISIS before performing a scan. In the Hologic computer click the “Perform Exam” icon or “Exam” in the top menu bar and select “Perform Exam” from its drop-down menu (Exhibit 3-5).

**Exhibit 3-5. Selecting “perform exam”**



### 3.5.1 Selecting an SP

In the “Patient Selections” screen, enter the SP ID from the ISIS screen into the blank white field for Patient Name, or highlight the SP ID from the list of IDs under the Patient Name column.

**Double-check that you entered the correct SP ID by asking the SP for his or her date of birth.** Press “OK.” See Exhibit 3-6.

**Exhibit 3-6. Patient selection screen**

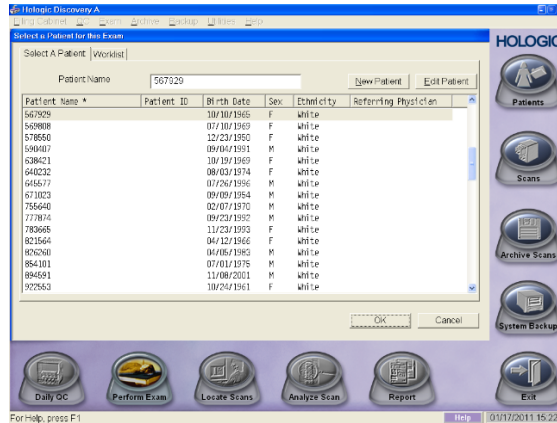

Enter your initials in the “Operator” field and click OK. See Exhibit 3-7.

**Exhibit 3-7. Operator field for initials**

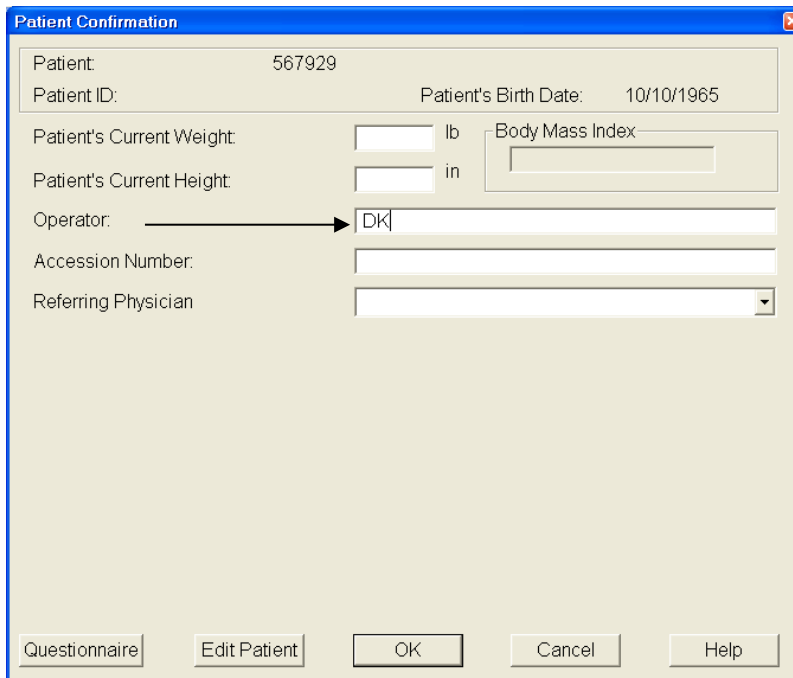

### 3.5.2 Selecting the Type of Scan

The next screen will display the types of scans to choose from. In the “scan selection” screen, select the scan type by clicking on “Whole Body” with the mouse. The scan type is highlighted. See

Exhibit 3-8. Click the “Next >>” button. Note that if the SP was selected for the high-power whole body option, select HP Whole Body from the scan selection screen.

### Exhibit 3-8. Scan selection screen

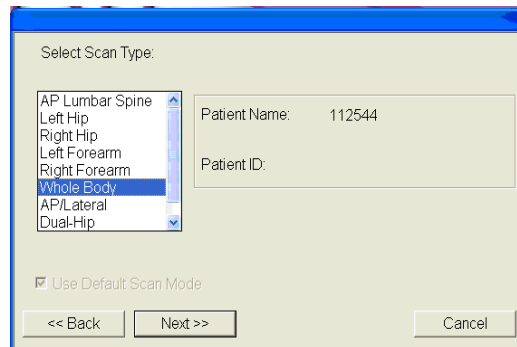

- The Whole Body Scan Parameters screen will display. See Exhibit 3-9 later in this chapter.
- Verify the SP ID under Patient Name and the scan type in the upper left corner. **Stop here** and position the SP for the scan.

## 3.5.3 Positioning the SP

Check to make sure the SP is in the center of the table with respect to the center lines at the head and foot of the pad. One method to check this is to position yourself at the foot of the table and look at the alignment of the body. Visualize a straight line from the nose, center of the body, and down through the knees and toes.

- Leave at least two finger spaces between the top border line and the SP’s head to avoid clipping the head in the scan.
- During the head positioning the chin should be straight to avoid the neckline being cut through the shoulder bone.
- The SP should lie flat on the table without a pillow. If the SP has trouble lying flat due to back problems or difficulty breathing, use the radiolucent pillow to support the head. The pillow should be covered with the disposable exam paper. If the pillow does not provide sufficient support, use the radiolucent foam block or one of the foam wedges. These may also be used under the knees if the SP has difficulty lying flat.

- If the SP continues to have difficulty lying flat or with the head slightly supported, exclude him or her from the exam.
- Gather the disposable scrub top on top of the belly area for proper hip positioning and tuck the disposable bottom under the hip area for leg positioning.
- The legs must be positioned together with the feet relaxed and toes pointed upwards. Use the Velcro strap around the ankles to support the legs in this position and to prevent any movement. Do not wrap the Velcro strap too tightly and make sure there is at least half an inch to an inch space between the feet. See Figure 3-4 for proper positioning of the whole body scan.
- Place the SP's arms straight at his or her sides, palms down, with separation from the torso. Verify that the arms are within the scan border. If necessary, with larger SPs the hands may be placed in a lateral position next to the hips to remain within 1" of the scan border. **Do not** tuck the hands under the body.
- **There must be a space between the SP's arms and sides whenever possible.**
- Remind the SP to breathe normally during the scan and pay attention to the SP while the C-arm is moving. Coach the SP through the scan; for example: "That was the first pass," "You are doing well," or "We're almost done."

Figure 3-4. Correctly positioned whole body scan

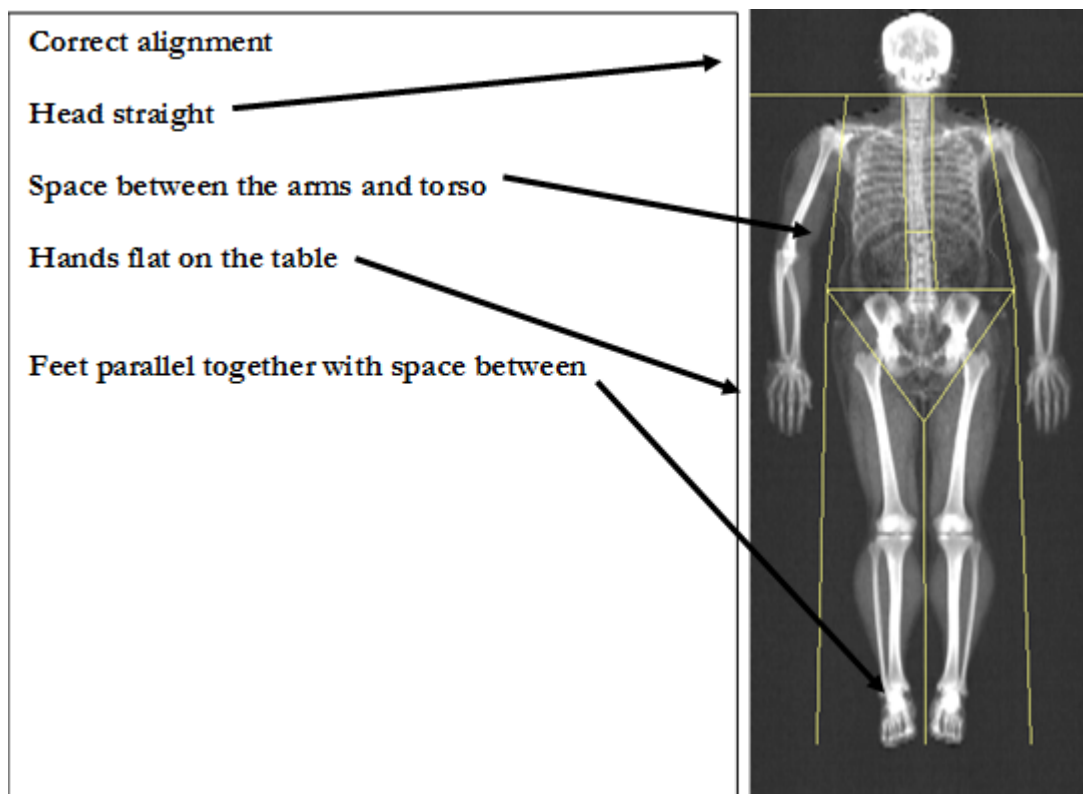

### 3.5.4 Reflection Positioning

There are several challenges in the scanning and analysis of heavy SPs. Reflection positioning should be used when an SP does not fit within the scan border. A “Reflection” protocol is where the patient is positioned off the center line of the scan table to ensure that one side, typically the right side, is completely included in the scan field. On the resulting image, the pelvis must be totally included. **All SPs ages 18-59 who require reflection positioning should receive a high-power whole body scan if not already identified by their BMI values.**

#### ***Positioning:***

- Position the subject the same as for a normally centered scan.
- Offset the SP to his or her left so the right side is included in the scan area; try to keep the torso within the scan area.
- The right side of the body and the left pelvis area should be at least one inch from the scan border. The entire pelvis including the bones and soft tissue must be within the scan border.
- Make sure the spine is straight (parallel to the center lines).
- There should still be separation of the hands and arms with the body.
- With the offsetting, **the left arm has to be out of the scan area up to and including the elbow** for the “Reflection” technique to activate. See Figure 3-5. The right hand should be flat on the table or lateral to the table to allow for separation between the hand and arm and the body (you may have to feel for the separation with some SPs).
- Place the cover over the control panel to prevent the emergency button from getting pushed.
- Scan the SP as usual.
- Be sure to mark Reflection positioning under the scan comments.

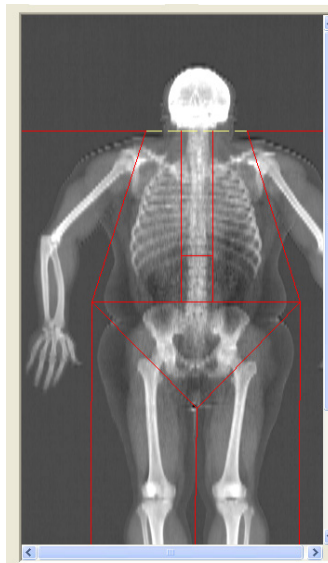
**Figure 3-5. Reflection positioning****Exhibit 3-9. Whole body scan parameters screen**

**Scan Parameters**

Patient Name:	112544
Patient ID:	
Scan Type:	a Whole Body
Scan ID:	X0809050R

Scan Length  in  
Scan Width 26.4 in  
Line Spacing 0.5130 in  
Point Resolution 0.0804 in

4.00 X 0.08 Coll.  
140/100 kVp  
0.8 mA avg.  
165 seconds  
60 Hz

**\*\* XRAY DEVICE READY \*\***  
You may begin scanning

Please position the patient for a Whole Body scan

- After the SP is positioned correctly for the whole body scan, check one more time to ensure there are no objects that will interfere with the movement of the table or the runner belt. Press “Start Scan” to begin the scan.
- The machine will complete the scan.

- **Warning:** If the Control Panel X-ray indicator fails to shut off within 10 seconds after the end of the scan, press the red **Emergency Stop** button immediately. Call the Hologic service representative before resuming operation.

### ***Positioning (Last Resort):***

- If an SP is very large and the technician is not able to image both sides of the torso on reflection, use the “last resort” procedure to attempt to obtain as much data as possible.
- Position the SP in the center of the table with both hands at his or her sides (same as for a normally centered scan under Section 3.5.3).
- Check to ensure there are no objects (including SP’s hands) that will interfere with the movement of the table or the runner belt. In this case, the main focus is the trunk and not including hands and arms is acceptable.
- Press “Start Scan” to begin the scan.
- Make sure to document this under the scan comments to be communicated with QC Reading Center.

### **3.5.5 Completing the Scan**

The Scan window displays with the image appearing on the left side. The flashing “X-rays On” indicator at the top of the window continues until the scan stops. See Exhibit 3-10.

Make sure the SP’s arms are included in the scan on the first and last pass of the C-arm. The SP should remain still until the scan is complete. Allow the scan to complete.

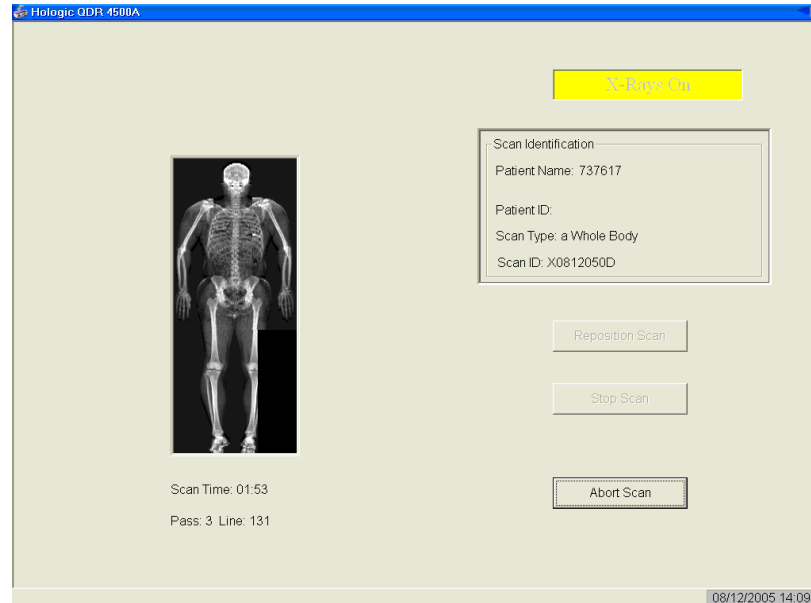
**Exhibit 3-10. Whole body scan image**

- The analysis will be done later by the QC Reading Center.
- Go to the ISIS screen and complete the DXA Data Entry screen.
- Remove the Velcro strap from the SP's ankle and clean it with a Sani-wipe.
- See Chapter 5 for a description of the information provided to the SPs from this test.
- When the exam completes, an Exit/New Scan window box displays. See Exhibit 3-11. Click on "Exit Exam."

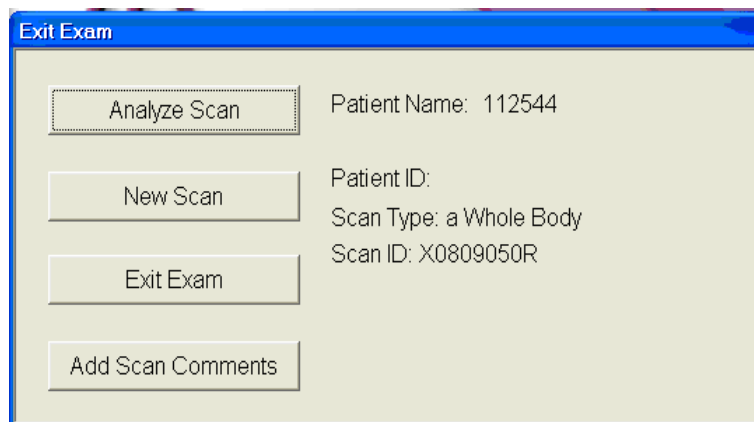
**Exhibit 3-11. Exit exam/new scan window box**



### 3.5.6 DXA Scan Data

- Analysis of the scans will be done at the QC Reading Center.
- Figure 3-6 shows the data displayed after the regions of interest are selected and the analysis is completed.
- This figure also displays the percent fat by region and for the total body. The percent total body fat for the hypothetical SP in the example is 23.6 percent.

Figure 3-6. Data displayed after analysis (1)

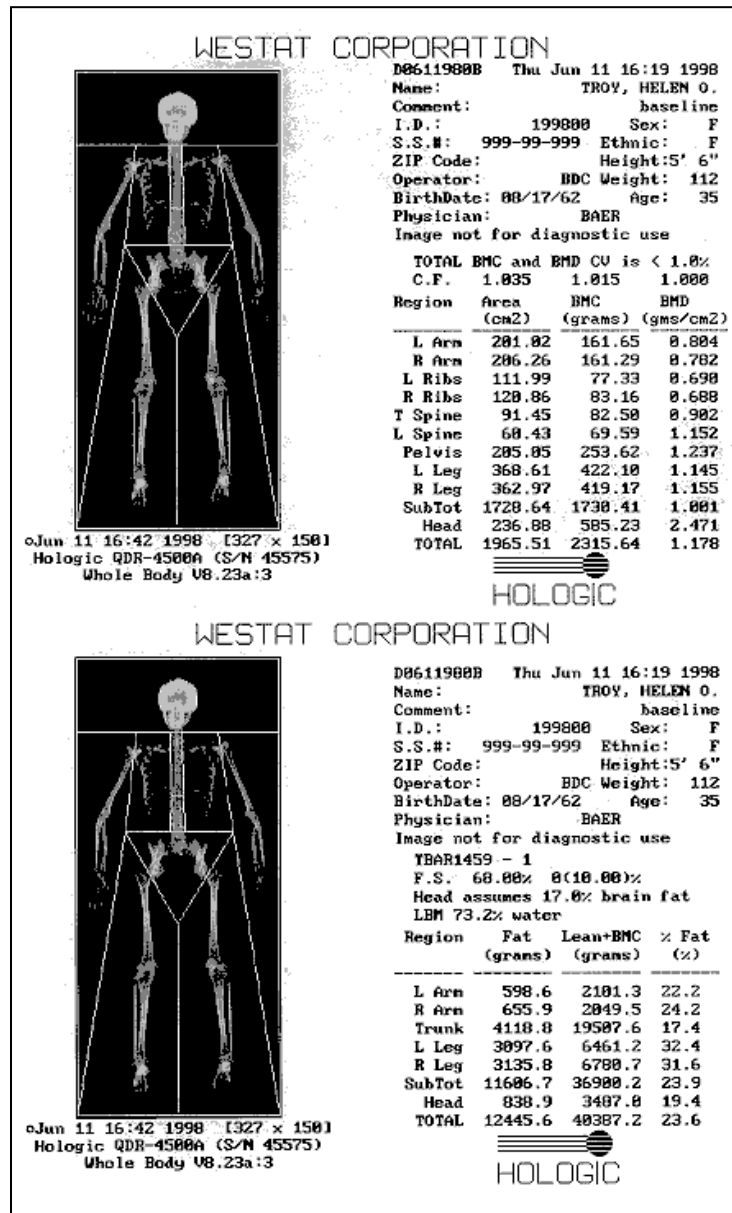

## 3.6 Proximal Femur Scan

### 3.6.1 Selecting the SP

If this is the first scan for the SP, click the “Perform Exam” icon or “Exam” in the top menu bar and select “Perform Exam” from its drop-down menu. See Exhibit 3-5 earlier in this chapter.

If the Whole Body scan has already been performed, click “New Scan” from the Exit/New Scan window (see Exhibit 3-11) earlier in this chapter.

### 3.6.2 Selecting the Type of Scan

At the “scan selection” screen (Exhibit 3-12), choose left hip, unless answers to safety exclusion questions warrant using the right hip.

**Exhibit 3-12. Scan selection screen**

Select Scan Type:

REGULAR WB  
HIGH POWER WB  
AP Lumbar Spine  
Left Hip  
Right Hip  
Left Forearm  
Right Forearm  
Whole Body

Patient Name: 214617  
Patient ID:

Use Default Scan Mode

<< Back    Next >>    Cancel

Click to **uncheck** the “Use Default Scan Mode” (Exhibit 3-13) and click “Next >>.”

**Exhibit 3-13. Default Scan Mode unchecked**

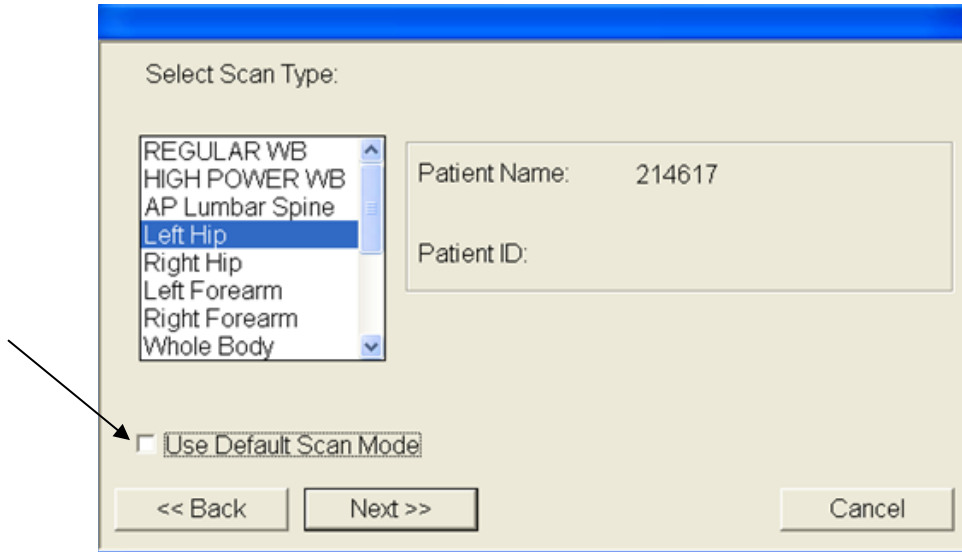

In the Left Hip Scan Mode window (Exhibit 3-14) select “**Fast Array (f)**” and click “Next >>.”

**Exhibit 3-14. Left Hip Scan Mode Selection**

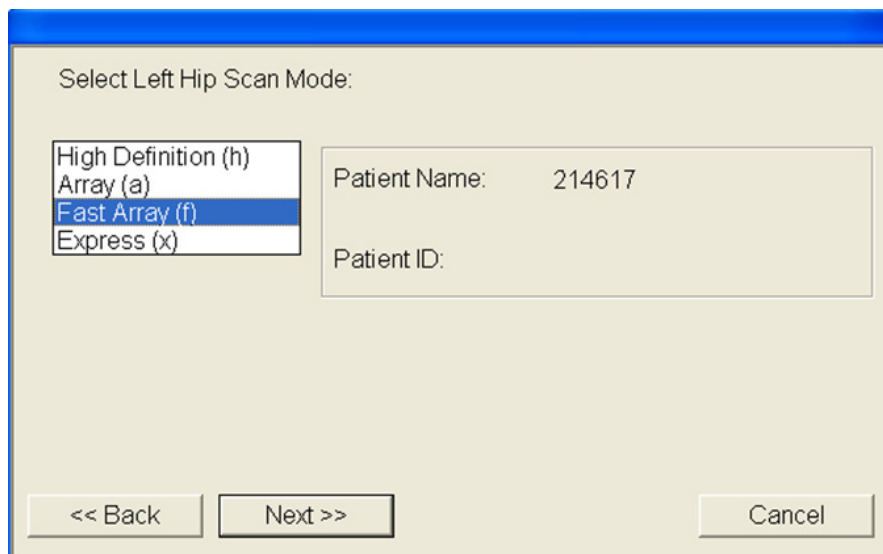

The Scan Parameters window appears (see Exhibit 3-15). Verify the SP ID and scan type in the upper left corner.

**Exhibit 3-15. Scan Parameters window for proximal femur scan**



### 3.6.3 Positioning the SP

The SP should be positioned with his or her head to your right as you face the table. Make sure that the SP is straight and centered on the table. The hip region should be within the two sets of hash marks on either side of the long edge of the table (see Figure 3-7).

**Figure 3-7. SP positioning for femur scan**

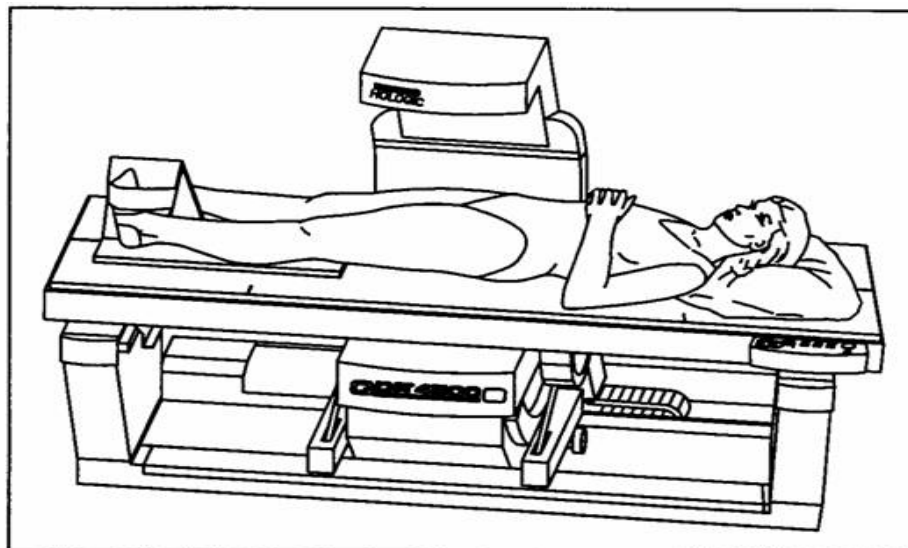

- On the control panel, press the Center Table switch to move the table and C-arm to the center position.
- Place the foot positioner under the SP's legs, and align the center of the positioner with the patient's midline. The leg to be examined should be rotated inward so that the foot can be placed against the foot positioner and secured with the Velcro strap (Figure 3-8). A soft rubber ball can be used between the heel of the foot and the foot positioner.
- The foot should be flexed toward the ceiling. Adjust the abduction of the leg so that the shaft of the femur is straight and parallel with the center of the table.

**NOTE:** In rotating the leg inward, place one hand above the knee and one hand below the knee and gently rotate the leg to ensure the whole leg is rotated, as opposed to just the lower portion of the leg. Another option is to pick up the leg, bend it outward at the knee, then rotate the leg inward, sliding the foot down the foot positioning device. Do not rotate more than is needed to minimize the lesser trochanter.

- Make sure that the SP's arms are placed across his or her chest outside of the scanning area to prevent the SP from placing his or her thumb or fingers under the hip.

**Figure 3-8.** Foot placement against hip scan positioning fixture

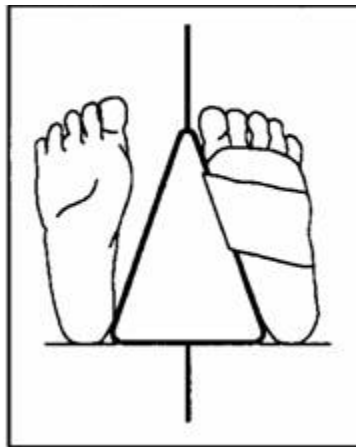

### 3.6.4 Positioning the C-Arm and Aligning the Laser

Locate the SP's greater trochanter. This can be done as described below:

- Grasp the leg to be scanned near the ankle and gently rotate the leg inward and outward several times. Press firmly on the outside of the thigh while rotating the leg. You should feel the greater trochanter roll under your fingertips.

- If you are not able to feel the trochanter, have the SP bend the leg at the knee and lift (may be necessary to assist the SP). Locate the crease formed at the top of the leg and use this as an approximate location of the greater trochanter.
- In both cases, these are approximate location(s) to begin the scan.
- Move the C-arm until the laser crosshair is 2 inches below the level of the greater trochanter and is on the center shaft of the femur (Figure 3-9). See “Starting Point Left” and “Starting Point Right.”
- Align the femoral shaft so it is parallel to the horizontal line of the laser.

Figure 3-9. Starting point and reposition mark for femur scan

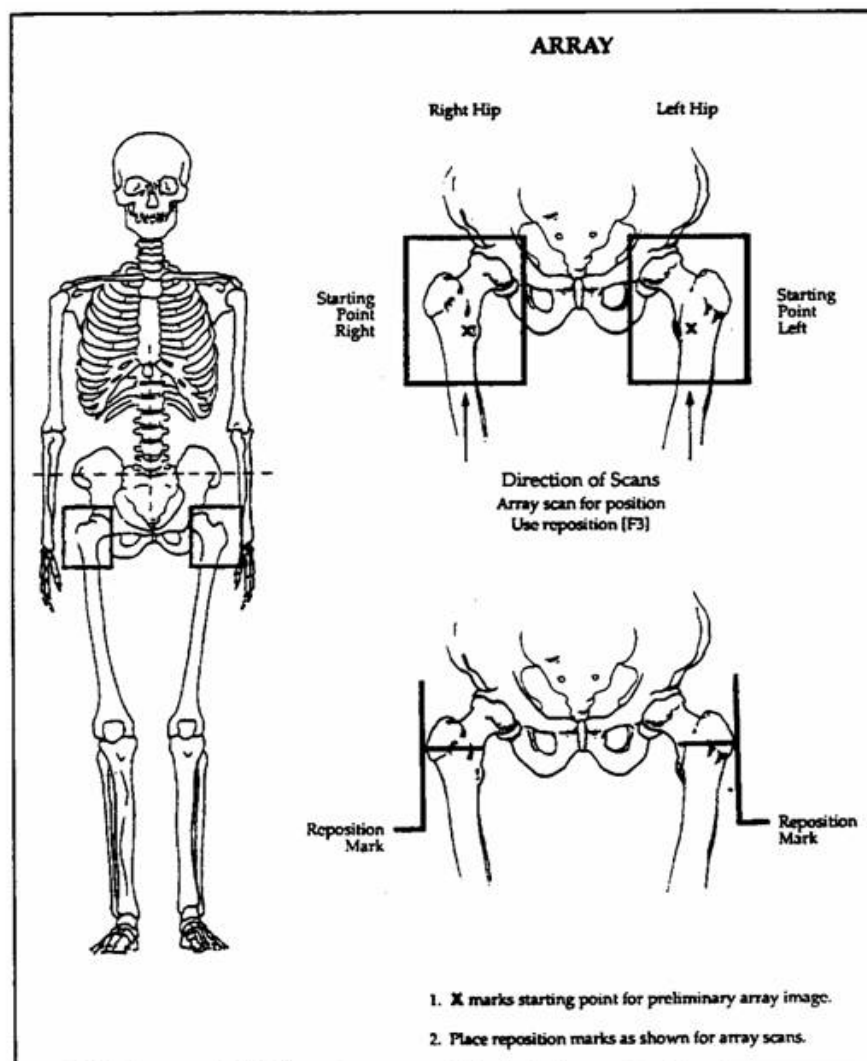

### 3.6.5 Scanning

Reconfirm that the SP is properly positioned and press “Start Scan” to begin the scan. The Scan window displays with the image appearing on the left side. The flashing “X-rays On” indicator at the top of the window continues until the scan stops. The image will appear on the screen, one line at a time from the bottom up (Exhibit 3-16).

**Exhibit 3-16. Hip scan window**

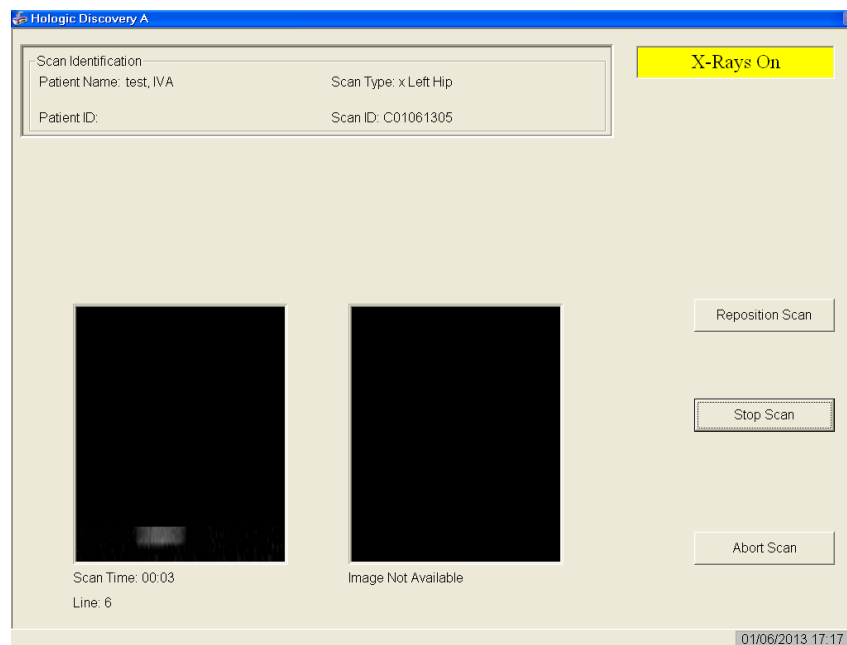

Inspect the image as it is generated. If the hip is positioned correctly, allow the scan to complete. If the hip is not positioned correctly, click the “Reposition Scan” button to stop the scan when the outer edge of the greater trochanter can be identified. If needed, straighten the femur shaft when scanning and continue the scan until the flexion between the head of the femur and the neck of the femur can be seen. Then reposition the image to the correct centering point and obtain the scan.

**NOTE:** An acceptable hip scan includes the following:

- The femoral shaft is **straight and parallel** to the edge of the scan image.
- The scan includes the **entire femoral head, neck, and approximately 3 inches of the shaft.**
- The greater trochanter is centered vertically in the window.

- A 25° internal hip rotation of the hip showing minimal or no lesser trochanter on the scan image.

**NOTE:** If the scout scan reveals that the SP has a hip replacement or pin previously not reported, stop the scan and proceed with scan on the other hip, if possible. If this is not possible, discontinue the scan and complete the Femur Scan data entry scan to document the reason for the incomplete scan.

Reposition the image up, down, left, or right using the scroll bars or cursor hand to include the entire femoral head, neck, and approximately 3 inches of the shaft (see Exhibit 3-17, Repositioning the femur). **If the femoral shaft is not parallel with the edge of the scan, move the SP's leg away from or toward the midline.**

The new starting point is automatically adjusted to have the correct amount of soft tissue lateral to the greater trochanter.

#### Exhibit 3-17. Repositioning the femur

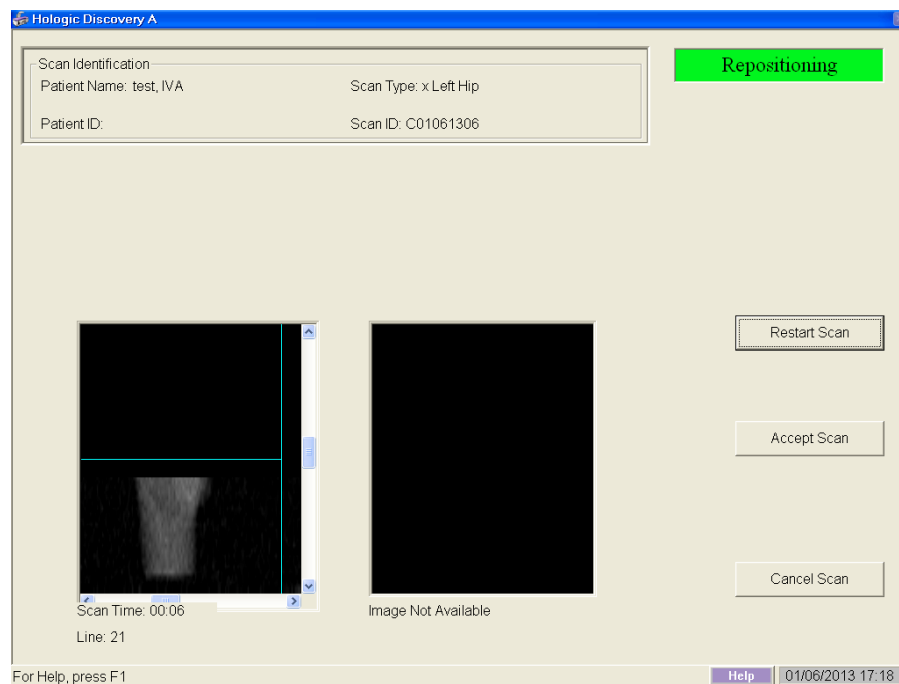

- Press “Restart Scan” to return to the scan parameter screen.
- When the Scan Parameter screen re-appears, press “Start Scan” to repeat the scanning process.



- The scanning will start from the corrected starting point. Repeat the re-scan process one more time if necessary. The scan should only be repositioned a maximum of 2 times... See Figure 3-10 for an example of a properly aligned and rotated femur scan.

**Figure 3-10. Properly aligned and rotated femur scan**

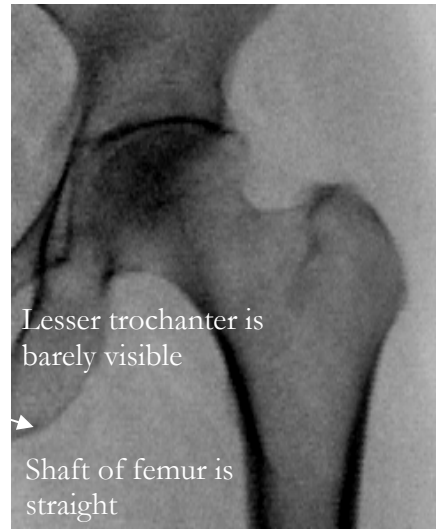

- The analysis will be done later by the QC Reading Lab.
- Go to the ISIS screen and complete the Femur Scan screen. Be sure to inspect the scan thoroughly to include any comments that may be necessary.
- Remove the SP's leg from the hip positioning device.

### 3.6.6 Panniculus (Belly Fat Pad)

On very obese SPs, the fat pad of the belly can overlie the head of the femur, changing the bone mineral density (BMD) value. This is a major source of error that will cause the analysis of the scan to be inaccurate.

When presented with an obese SP, gently palpate the area to determine if there will be obesity noise. Ask the SP to hold the fat pad out of the way with his or her hands by pulling it up and away from the femoral area. If unsure from palpation, start the scan, and if obesity noise is present, repeat the scan with the panniculus retracted.

Document this on the DXA Proximal Femur Data Capture Screen in the “Other” text box under “Comment on scan” by typing, for example, “Belly fat pad retracted.”

## 3.7 AP Lumbar Spine Scan

### 3.7.1 Selecting the SP

If this is the first scan for the SP, click the “Perform Exam” icon or “Exam” in the top menu bar and select “Perform Exam” from its drop-down menu. See Exhibit 3-5 earlier in this chapter.

If the femur scan has already been performed, click “New Scan” from the Exit/New Exam windows box. See Exhibit 3-11 earlier in this chapter.

### 3.7.2 Selecting the Type of Scan

In the “scan selection” screen select the scan type by clicking on “AP Lumbar Spine” with the mouse. The scan type is highlighted. See Exhibit 3-18.

**Exhibit 3-18. Scan selection screen**

Select Scan Type:

REGULAR WB  
HIGH POWER WB  
AP Lumbar Spine  
Left Hip  
Right Hip  
Left Forearm  
Right Forearm  
Whole Body

Patient Name: 214617  
Patient ID:

Use Default Scan Mode

<< Back    Next >>    Cancel

**Uncheck** the “Use Default Scan Mode” (Exhibit 3-19) and click “Next >>.”

**Exhibit 3-19. AP Lumbar Spine Scan Default Scan Mode unchecked**

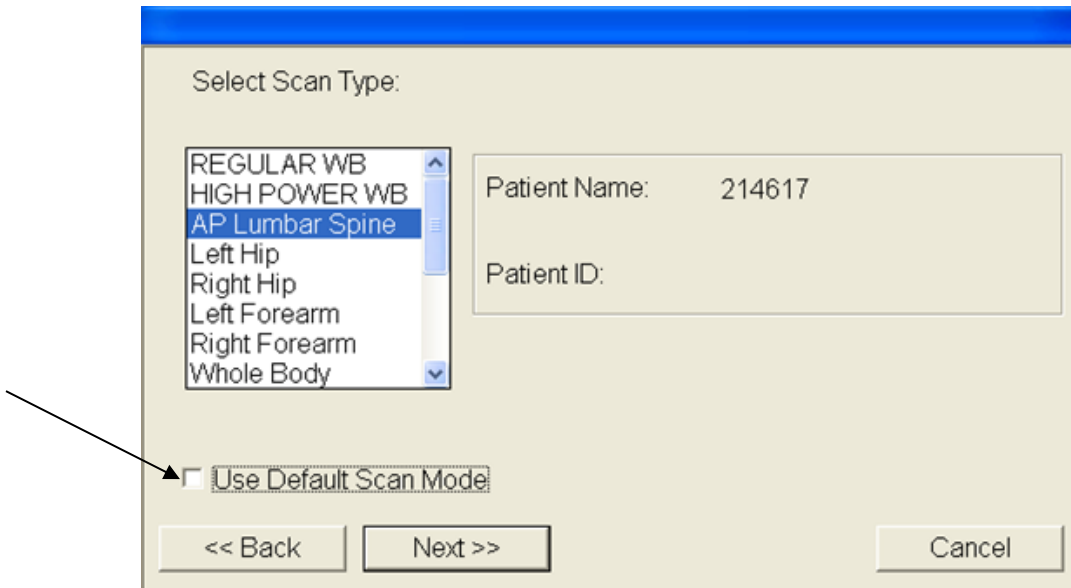

In the AP Lumbar Spine Scan Mode window (Exhibit 3-20) select “**Fast Array (f)**” and click “Next >>.”

**Exhibit 3-20. AP Lumbar Spine Scan Mode Options**

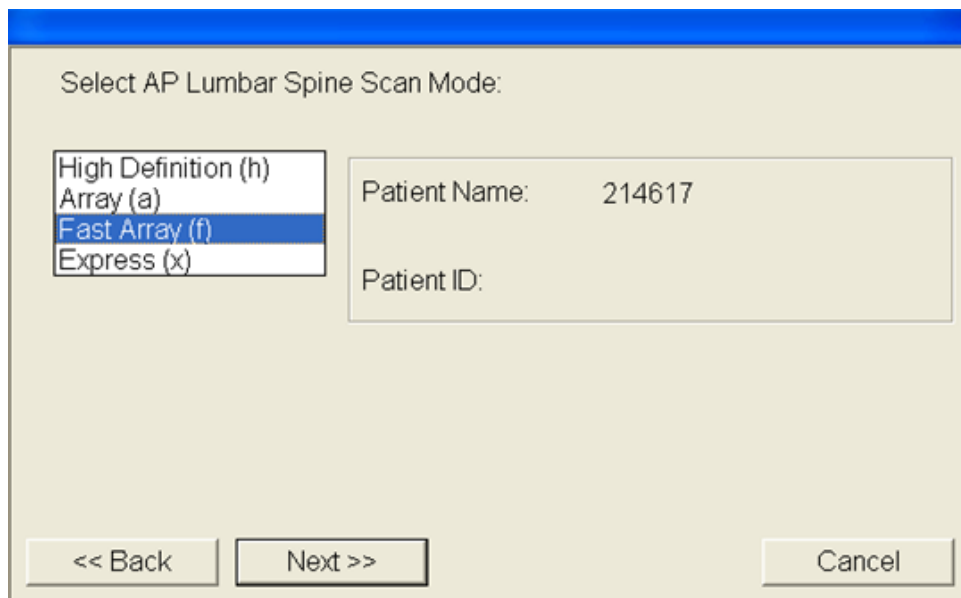

The AP Lumbar Spine Scan Parameters screen will display. See Exhibit 3-21. Verify the SP’s name and scan type in the upper left corner.

Stop here and position the SP and the C-arm.

**Exhibit 3-21. AP Lumbar Spine Scan Parameters screen**

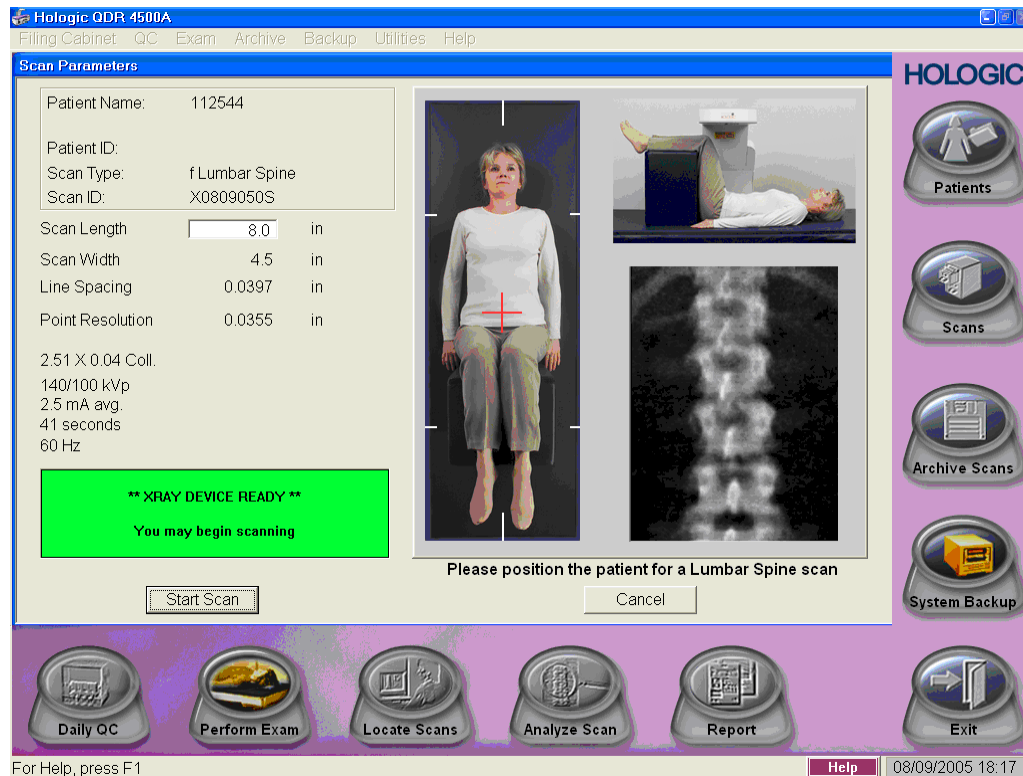

### 3.7.3 Positioning the SP

The SP should be positioned with his or her head to your right as you face the table. Make sure that the SP is straight and centered on the table and that his or her shoulders are **3-4 inches below** the upper scan limit hash marks on the long edges of the table. See Figure 3-11.

**NOTE:** It may be helpful to stand at the head end of the DXA table, reach under the SP's underarms, and gently pull toward you to straighten the spine.

- On the control panel, press the center table switch to move the table and C-arm to the center position.
- Place the large cubed cushion under the SP's lower legs with the thighs as close to a 90-degree angle to the body as possible. Use the proper dimension of the cushion since the longest dimension could lift the SP's buttocks off the table, causing the SP to rotate. It

is important to have the SP stable and positioned. (See Figure 3-12.) Have the SP rest his or her arms comfortably at his or her sides.

- Scoliotic SPs should be positioned using the same guidelines. The spine should be centered in the scan field and straight as much as possible without causing undue discomfort to the SP.

**Figure 3-11. Lumbar spine positioning**

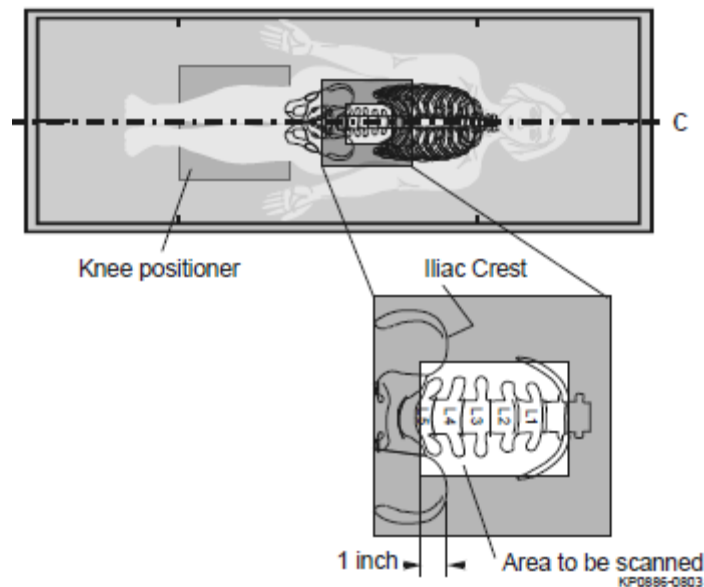

**Figure 3-12. Positioning of lower legs for spine scan**

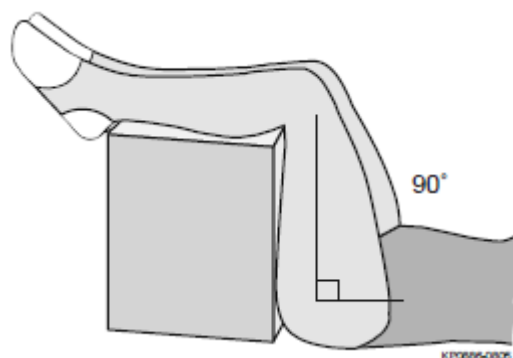

### 3.7.4 Positioning the C-Arm

Locate the SP's iliac crest. Using the arm motion controls on the control panel, bring the laser indicator vertical line to approximately 2 inches below the iliac crest. The laser indicator horizontal

line should coincide with the midline of the SP (see Figure 3-13). The laser indicator is projected when the motion control is activated.

**Figure 3-13.** Positioning for laser indicator for AP spine scan

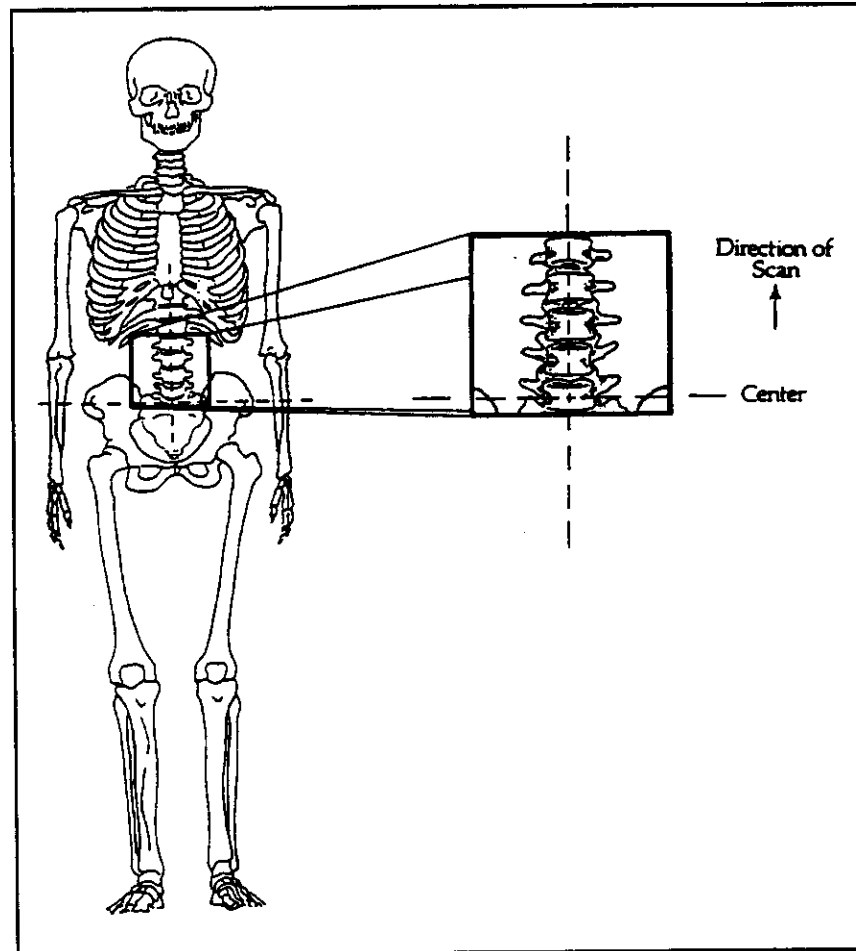

### 3.7.5 Scanning

Prior to beginning the scan, confirm that the SP's body is straight with respect to the laser, the table, and the lines on the table pad. Press "Start Scan" to begin the scan.

The Scan window displays with the image appearing on the left side. The flashing "X-rays On" indicator at the top of the window continues until the scan stops. See Exhibit 3-22.

Exhibit 3-22. Spine scan window

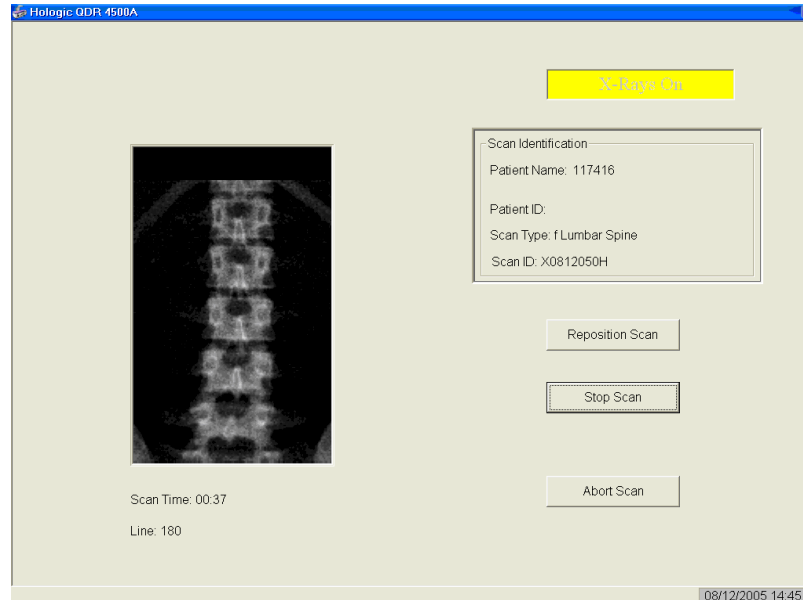

Make sure that the spine is centered and straight, there are even amounts of soft tissue on each side of the entire spine, and that a small amount of the iliac crest is visible in the lower corners of the screen. If not, click “Reposition Scan” to stop the scan before it is completed.

**NOTE:** An acceptable AP Lumbar Spine scan includes the following:

- The scan starts in the middle of L5.
- The iliac crest is evenly displayed in both lower corners of the image area.
- The spine is straight and centered in the middle of the scan window.
- There are even amounts of soft tissue on each side of the spine.
- The scan includes all of T12.
- The image acquired so far displays with scroll bars on the right and bottom. See Figure 3-14.
- Position the cursor over the spine image. The arrow cursor changes to a hand. Click and drag the image (or use the scroll bars) so that the iliac crest is at or below the blue horizontal positioning line and within the lower portion of the scan field. The center of the lumbar spine should be aligned with the blue vertical positioning line.

Figure 3-14. Repositioning the spine scan

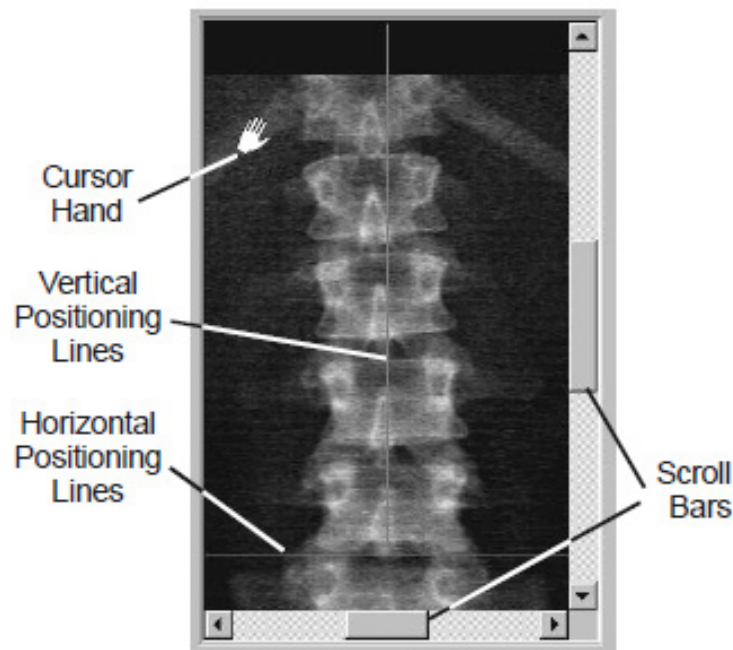

- If the spine is not straight, move the SP's upper torso either left or right to straighten the spine. When the spine is repositioned correctly, click the "Restart Scan" button. The Scan Parameters window displays. Click the "Start Scan" button to start a new scan at the new position. The Scan window displays with a flashing "X-rays On" message. The image displays. The AP Lumbar spine scan can be repositioned a maximum of two times.
- When you see the ribs attaching at T-12 (see Figure 3-14), click the "Stop Scan" button after **all** of T-12 has been scanned. When the scan completes, the Exit/New Exam window displays. See Exhibit 3-11 earlier in this chapter.
- The analysis will be done later by the QC reading lab.
- Go to the ISIS screen and complete the DXA Data Entry screen.

### 3.7.5.1 Adjusting the Default Length of the AP Spine Scan

For the majority of SPs, the default length settings for the spine scan will be appropriate and will result in a spine scan that properly shows a small amount of iliac crest in the lower corners of the scan, L1 through L5, and the ribs attaching at T-12 at the top of the scan. However, it is possible that for a tall SP, this length may not be adequate to include all necessary points of interest. If during



the scout scan it becomes apparent that the default length of the scan will not be adequate, it will be necessary to adjust the default length of the scan. This should be done as follows:

- As soon as it is apparent that the length of the scan is not adequate, press “Reposition Scan” to stop the scan.
- Make any adjustments that may be necessary and press “Restart Scan” to accept the new starting position.
- The scan parameters screen (see Exhibit 3-21) will be displayed. To change the scan length, place the cursor in the Scan Length field and type the new length, number “10,” and press “Start Scan.” The system may change the number entered to match the pre-programmed step size of the scanning mechanism.
- As a general rule, for SPs 5’8” or taller, the scan length should be increased prior to scanning.

### 3.7.6 DXA Scan Data

- Analysis of the scans will be done at the QC Reading Center.
- Figure 3-15 shows the data displayed after the regions of interest are selected and the analysis is completed.
- This exhibit also displays the percent of fat by region and for the total body. The percent of total body fat for the hypothetical SP in the example is 23.6 percent.

Figure 3-15. Data displayed after analysis (1)

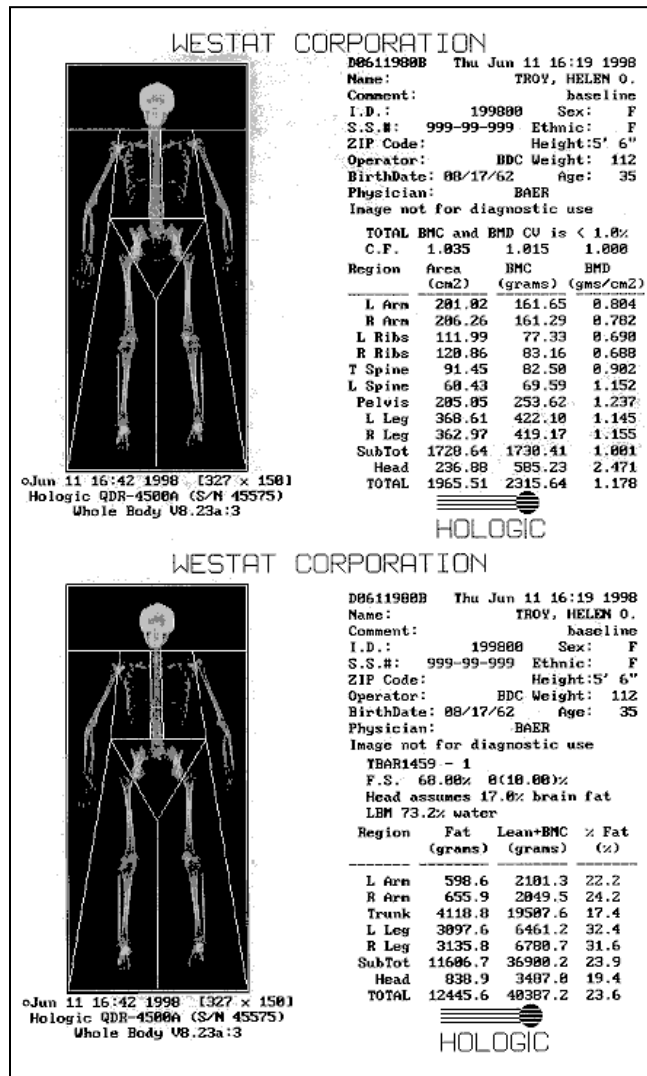
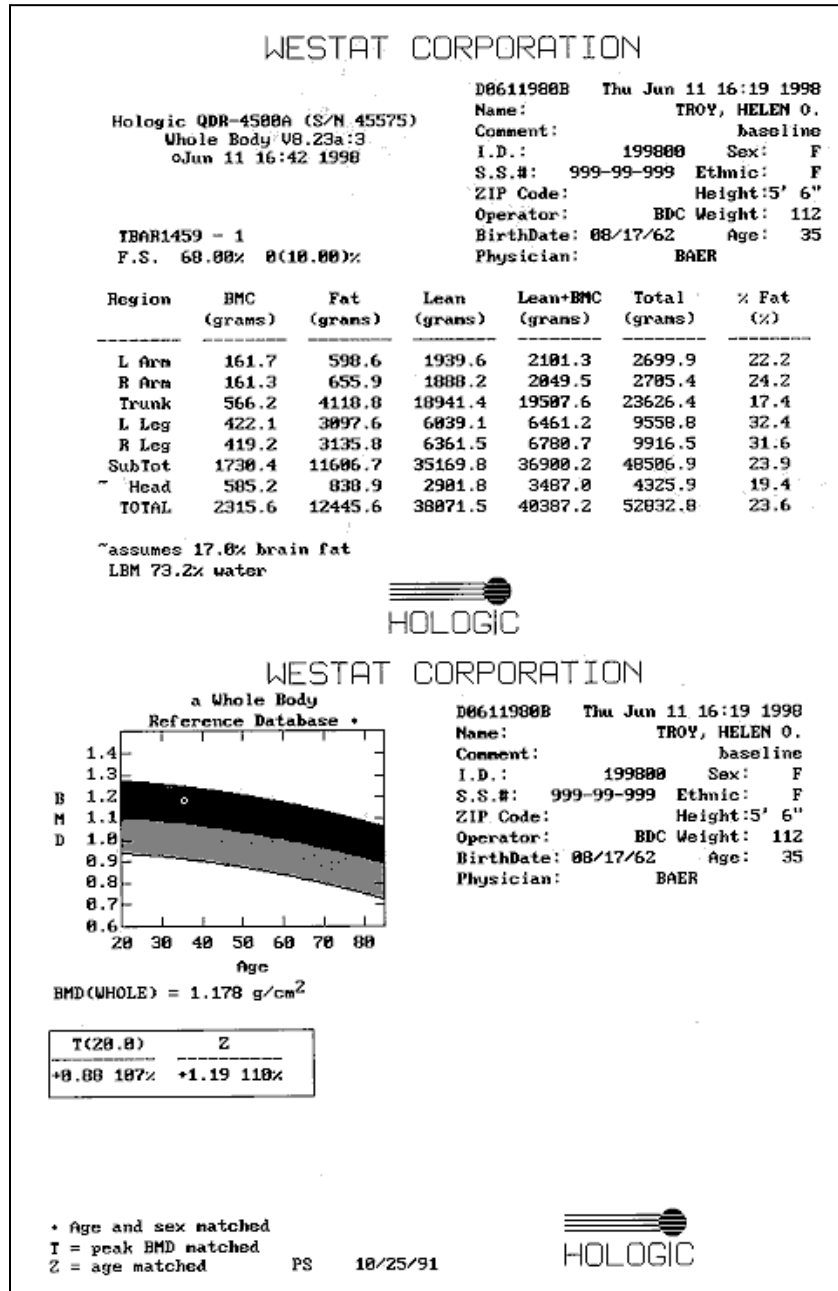

Figure 3-16 displays the bone mineral density (BMD) for the SP. In addition, the box below the graph gives the T-score and the Z score for the BMD for this SP.

Figure 3-16. Data displayed after analysis (2)



## 4.1 Shared Exclusion Questions

The Shared Exclusion Questions may be answered in several components in the MEC. If these questions have been answered in a previous component in the MEC, the questions and responses will be displayed in read-only format. If the sample person (SP) is excluded from this exam based on his or her answers to the Shared Exclusion Questions in another component, the SP would be blocked from the body composition by the Coordinator System and would not be sent to this exam. The Component Status for body composition for this SP would be set to “Not Done” with a comment specific to the reason for exclusion (safety exclusion, physical limitation, etc.).

**NOTE:** Not all of the Shared Exclusion Questions will exclude the SP from the DXA component. If you get a “Yes” response to certain Shared Exclusion Questions, the SP will not be excluded immediately. You must ask the remaining Shared Exclusion Questions and press the Next button before the SP is excluded. Other components will use the responses to these questions to determine eligibility. See Exhibit 4-1 for the Shared Exclusion Questions.

## Exhibit 4-1. Shared exclusion questions

Body Composition Exam Subsystem: Stand:615 Session:615271 09/22/2010 01:30 pm - 05:30 pm

DXA: Stand:615 Session:615271 09/22/2010 01:30 pm - 05:30 pm

SP ID: 908844 Name: TRUELOVE 1, ANN Age: 36 years Gender: Female Date: 04/19/2011 Time: 02:50 PM

**Shared Exclusion Questions**

Do you have a pacemaker or automatic defibrillator?

Are you currently pregnant?

In the past 7 days have you had any x-rays or scans that used contrast material such as dyes or barium?

Do you have any amputations of your legs and feet other than toes?

Where is the amputation?

1 of 5

End of Section Close Exam Finish

Ready MEC Layer: 2/22/2011 Application: 10.1.1 Not connected to Coordinator 02:48 PM

Start Body Composition Ex... 2:50 PM

*Do you have a pacemaker or automatic defibrillator?*

SPs are not excluded from DXA due to a pacemaker or automatic defibrillator.

*Are you currently pregnant?*

- If the response to the question “Are you currently pregnant?” is “Yes” or “Don’t Know,” the SP will be excluded from DXA due to pregnancy status.
- When the next button is pressed, a message will be displayed: “Excluded from DXA due to pregnancy status.” See Exhibit 4-2. Press OK to this message.

## Exhibit 4-2. Exclusion from DXA due to pregnancy status

The screenshot displays a software window titled "Body Composition Exam Subsystem: Stand:615 Session:615711 11/05/2010 01:30 pm - 05:30 pm". The window contains a "Shared Exclusion Questions" section with several questions and dropdown menus. A modal dialog box is open in the center, displaying an information icon and the text "Excluded from DXA due to pregnancy status." with an "OK" button. The background form includes questions such as "Do you have a pacemaker or automatic defibrillator?", "Are you currently pregnant?", "In the past 7 days have you had dyes or barium?", "Do you have any amputations?", and "Where is the amputation?". The status bar at the bottom shows "Ready", "MEC Layer: 12/23/2010", "Application: 10.0.4", "Not connected to Coordinator", and "02:31 PM".

The Component Status will be set to “Not done” with the comment “SP pregnant.” If the SP is male or a female 8-15 years, the pregnancy question will not be displayed. See Exhibit 4-3. (The question on self-reported pregnancy status for 12- to 15-year-old females will be asked in the physician’s exam or in phlebotomy.)

Exhibit 4-3. Shared exclusion questions without pregnancy question

The screenshot displays a software window titled "Body Composition Exam Subsystem: Stand:615 Session:615271 09/22/2010 01:30 pm - 05:30 pm". Below the title bar is a menu bar with "File", "View", "Utilities", "Reports", "Window", and "Help". A toolbar contains icons for file operations and navigation. The main content area is titled "DXA: Stand:615 Session:615271 09/22/2010 01:30 pm - 05:30 pm" and shows patient information: "SP ID: 107034 Name: NARDIMPALLI 1, SAHITI Age: 10 years Gender: Female Date: 04/19/2011 Time: 02:48 PM". Below this is a section titled "Shared Exclusion Questions" with the following questions and dropdown menus:

- Do you have a pacemaker or automatic defibrillator? [Dropdown menu]
- In the past 7 days have you had any x-rays or scans that used contrast material such as dyes or barium? [Dropdown menu]
- Do you have any amputations of your legs and feet other than toes? [Dropdown menu]
- Where is the amputation? [Dropdown menu]

At the bottom of the window, there is a navigation bar with "End of Section", "Close Exam", and "Finish" buttons, and a status bar showing "Ready", "MEC Layer: 2/22/2011", "Application: 10.1.1", "Not connected to Coordinator", and "02:48 PM". The Windows taskbar at the very bottom shows the Start button, "Body Composition Ex...", and the system clock at "2:49 PM".

*In the past 7 days, have you had any x-rays or scans that used contrast material such as dyes or barium?*

If the response to the question “In the past 7 days have you had any x-rays or scans that used contrast material such as dyes or barium?” is “No,” continue with the next questions.

- If the response to the question is “Yes,” the SP will be excluded from DXA.
- Complete the remainder of the questions. When the Next button is pressed, a message will be displayed: “Excluded from DXA due to data effect.” See Exhibit 4-4. Click OK to this message.

**Exhibit 4-4. Exclusion from DXA due to data effect**

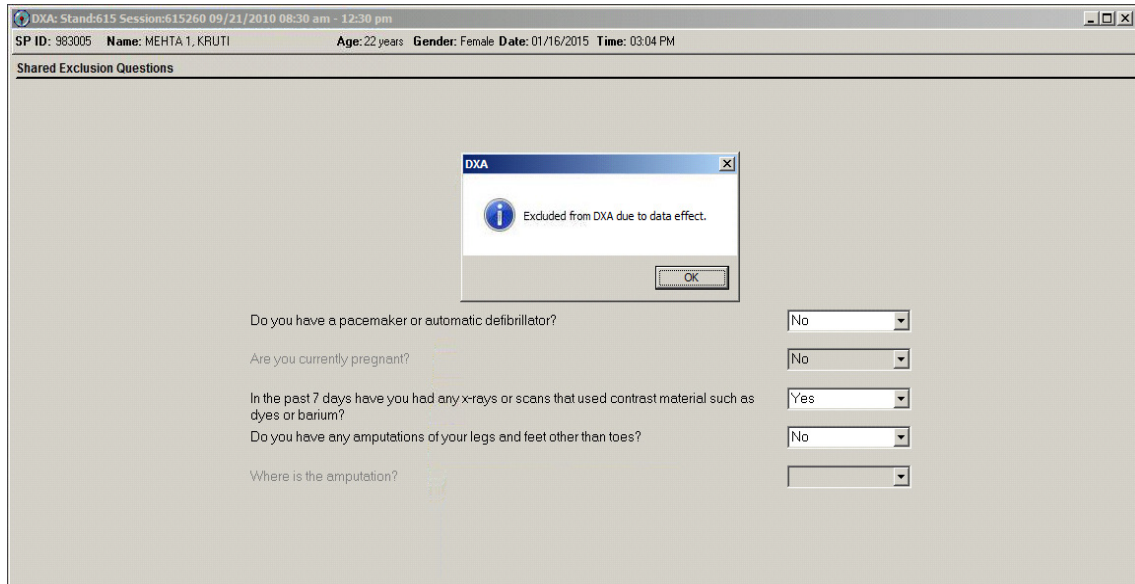

The DXA Component Status will be set to “Not Done” with the comment “data effect.” See Exhibit 4-5.

**Exhibit 4-5. Exam status “not done” due to data effect**

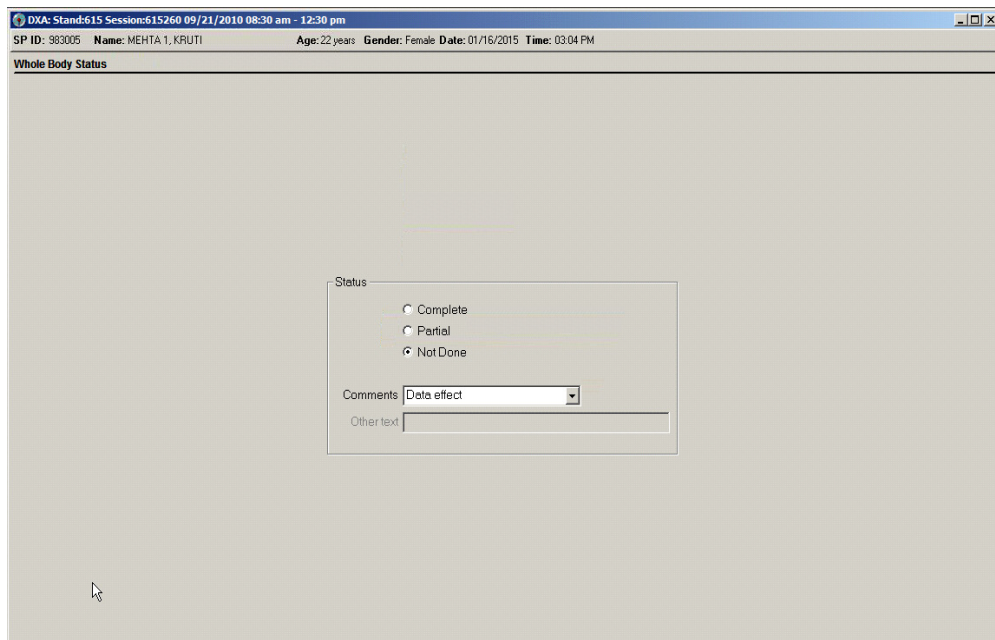



*Do you have any amputations other than fingers and toes?*

- SPs are not excluded from the DXA exam based on an amputation. If the answer to “Do you have any amputations other than fingers and toes?” is “No,” the SP remains eligible for the exam.
- If the response is “Yes,” the question “Where is the amputation?” will be highlighted with response options of Right, Left, or Both. See Exhibit 4-6.

**Exhibit 4-6. Response options for question “where is the amputation?”**

The screenshot shows the 'Body Composition Exam Subsystem' interface. The title bar indicates the session details: 'Stand:615 Session:615512 10/16/2010 05:30 pm - 09:30 pm'. The main window displays the 'Shared Exclusion Questions' section for a patient named WANG, MARY D. The questions and their current answers are:

- Do you have a pacemaker or automatic defibrillator? (Yes)
- Are you currently pregnant? (No)
- In the past 7 days have you had any x-rays or scans that used contrast material such as dyes or barium? (No)
- Do you have any amputations of your legs and feet other than toes? (Yes)
- Where is the amputation? (Right, Left, Both)

The interface includes a navigation bar at the bottom with buttons for 'End of Section', 'Close Exam', and 'Finish'. The status bar at the very bottom shows system information: 'Ready | MEC Layer: 12/23/2010 | Application: 10.0.4 | Not connected to Coordinator | 02:19 PM'.

- When all Shared Exclusion Questions are answered, the system will display a series of messages regarding the exclusions to other components based on the question.
- If there are no exclusions based on the Shared Exclusion Questions, press the “Next” button. The system will advance to the Weight/Height data entry screen.

## 4.2 Weight/Height Entry Screen

After answering the Shared Exclusion questions, the next screen displayed will be the weight/height data entry screen. See Exhibit 4-7. Due to limitations of the DXA table, SPs may be excluded from DXA due to their height and/or weight. If the SP was in the anthropometry (body measures [BM])

component prior to this test, the weight and height will already be uploaded and displayed on the ISIS screen, along with the component it transferred from (i.e., BM). This information will be grayed out. See Exhibit 4-8. If the information is not displayed, you will need to measure the SP's weight and height using the floor scale and stadiometer in the room. Enter these numbers into the white entry fields next to "Weight" and "Height." See Exhibit 4-9. For instructions on measuring weight and height, see Section 3.4.1.

**NOTE:** If the SP's weight is more than 450 lbs., or the height is greater than 6'5", he or she will be excluded from the exam.

**Exhibit 4-7. Weight/height entry screen**

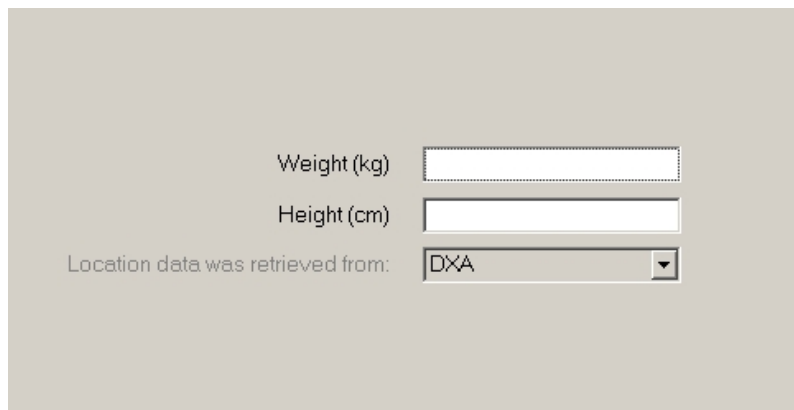

Weight (kg)

Height (cm)

Location data was retrieved from:

**Exhibit 4-8. Weight/height information transferred from body measures**



Weight (kg)

Height (cm)

Location data was retrieved from:

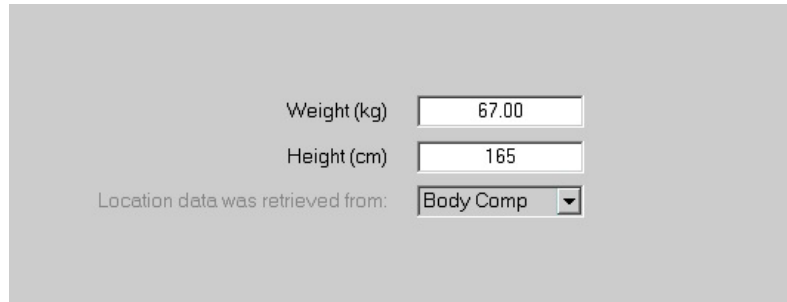
**Exhibit 4-9. Entering the weight/height information into the screen**

A screenshot of a data entry screen with a light gray background. It features three input fields: 'Weight (kg)' with the value '67.00', 'Height (cm)' with the value '165', and a dropdown menu labeled 'Location data was retrieved from:' with 'Body Comp' selected. The fields are arranged vertically and are part of a larger form.

The system will use the height and weight measurements to calculate the body mass index (BMI), which will determine whether the SP needs the high-power whole body scan or not. Females with a  $\text{BMI} \geq 32$  and males with a  $\text{BMI} \geq 31$  will be selected for this option if they are 18 years or older. If the SP has been selected for the high-power whole body scan, a message will display on the screen (see Exhibit 4-10) and again in Whole Body Data Capture Screen, notifying the tech to select this option when performing the scan. See Section 4.4, Exhibit 4-21. SPs selected for the high-power option may also be excluded if there is less than 6 inches of clearance between the SP and the C-arm.

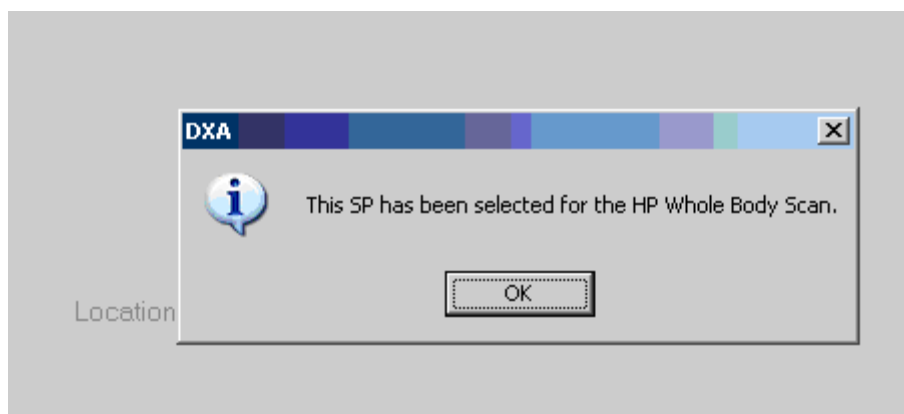
**Exhibit 4-10. Selection for high-power scan**

### 4.3 Screening and Safety Questions

The screening and safety questions should be read exactly as written. Read the entire question before accepting an answer. If the SP interrupts you before you have completed reading the question, say that you are required to read the entire question before accepting an answer. See Exhibit 4-11.

**Exhibit 4-11. Screening questions**

**Screening/Safety Exclusion**

**Observation**  
Does the SP have any amputations other than fingers or toes?

**Screening**  
Have you removed all jewelry, eyeglasses, hair ornaments, and other objects from your hair and body?   
Have you removed wallets, keys, and other objects from all of your pockets?   
Do you have any artificial joints, pins, plates, metal suture material, or other types of metal objects in your body?   
Are you using an insulin pump or have insulin lines now?   
Do you have an ostomy, such as an ileostomy or colostomy?   
Are you wearing a hearing aid now?

**Safety Exclusion**  
Do you have a Harrington rod in your spine for scoliosis?   
Have you ever fractured your hip, had a hip replacement, or do you have a pin in your hip?   
Is it your right hip, left hip, or both?

**Screening**  
Have you removed your bra? Wearing a bra may affect the results of your tests.   
Could you remove it please?

Observation question:

“Does the SP have any amputations other than fingers and toes?”

The first question on the screen is an observation question for the technologist and is not to be asked of the SP. It is not a safety exclusion; therefore, answering “Yes” will not exclude the SP from any DXA exams, but it may affect the analysis of the scans.

Screening questions:

- Have you removed all jewelry, eyeglasses, hair ornaments, and other objects from your hair and body?
- Have you removed wallets, keys, and other objects from all of your pockets?
- Do you have any artificial joints, pins, plates, metal suture material, or other types of metal objects in your body?
- Are you using an insulin pump or have insulin lines now?
- Do you have an ostomy, such as an ileostomy or colostomy?
- Are you wearing a hearing aid now?

- Have you removed your bra? Wearing a bra may affect the results of your tests. (Asked of females only.)
- If the SP answers “No,” the question “Could you remove it please?” will be highlighted with options of “SP removed bra,” or “SP refused to remove bra” (see Exhibit 4-12). If the SP needs to remove her bra, pause the exam and escort her to the nearest restroom after all the questions have been answered.

**NOTE:** SP will not be excluded from any exams if her bra has not been removed.

#### Exhibit 4-12. Screening question highlighted with options

The screenshot shows a software window titled "DXA: Stand:615 Session:615260 09/21/2010 08:30 am - 12:30 pm". The patient information at the top includes: "SP ID: 918691 Name: MEHTA 4, KRUTI Age: 22 years Gender: Female Date: 01/16/2015 Time: 03:11 PM". The main section is titled "Screening/Safety Exclusion".

Under the "Observation" section, there is a question: "Does the SP have any amputations other than fingers or toes?" with a dropdown menu set to "Yes".

Under the "Screening" section, there are several questions with dropdown menus:

- "Have you removed all jewelry, eyeglasses, hair ornaments, and other objects from your hair and body?" (Yes)
- "Have you removed wallets, keys, and other objects from all of your pockets?" (Yes)
- "Do you have any artificial joints, pins, plates, metal suture material, or other types of metal objects in your body?" (No)
- "Are you using an insulin pump or have insulin lines now?" (No)
- "Do you have an ostomy, such as an ileostomy or colostomy?" (No)
- "Are you wearing a hearing aid now?" (No)

Below these, another "Screening" section contains:

- "Have you removed your bra? Wearing a bra may affect the results of your tests." (No)
- "Could you remove it please?" (This question is highlighted in yellow, and its dropdown menu is open, showing two options: "SP removed bra" and "SP refused to remove bra".)

Safety exclusion questions:

- Do you have a Harrington rod in your spine for scoliosis? If the SP answers “Yes,” he or she will be excluded from all spine scans. See Exhibit 4-13.

Exhibit 4-13. Exclusion from spine scans

The screenshot shows a DXA data entry interface. A modal dialog box is open in the foreground with the title 'DXA' and a red 'X' icon. The message inside the dialog reads: 'SP is excluded from spine scan for safety reasons.' Below the message is an 'OK' button. In the background, the main form contains several questions with dropdown menus:

- Are you using an insulin pump or have insulin lines now? No
- Stomach surgery, ileostomy or colostomy? No
- Wearing a hearing aid now? No
- Do you have a Harrington rod in your spine for scoliosis? Yes
- Have you ever fractured your hip, had a hip replacement, or do you have a pin in your hip? No
- Is it your right hip, left hip, or both? (dropdown menu)

- Have you ever fractured your hip, had a hip replacement, or do you have a pin in your hip?

If the answer is “Yes,” the question “Is it your right hip, left hip, or both?” will be highlighted to determine which hip the SP is referring to.

- If **Both** is chosen, the SP **will** be excluded from the femur scan for safety reasons. See Exhibit 4-14.
- If **Left Hip Only** is chosen, the SP **will not** be excluded from the femur scan. The femur scan will be conducted using the SP’s right hip. See Figure 4-15.
- If **Right Hip Only** is chosen, the SP **will not** be excluded from the femur scan. The femur scan will be conducted using the SP’s left hip as per protocol. See Exhibit 4-16.

Exhibit 4-14. Femur scan exclusion

The screenshot shows the same DXA data entry interface as Exhibit 4-13. The modal dialog box is open with the message: 'SP is excluded from femur scan for safety reasons.' In the background, the 'Have you ever fractured your hip...' question is now set to 'Yes', and the 'Is it your right hip, left hip, or both?' dropdown menu is highlighted and set to 'Both'.

**Exhibit 4-15. Scan right hip message**

The screenshot shows a software interface with a warning dialog box and a data entry form. The dialog box, titled 'DXA', contains a red 'X' icon and the text 'Proceed with femur scan on right hip for safety reasons.' with an 'OK' button. The background form includes several dropdown menus: 'ostomy or colostomy?' (No), 'ng a hearing aid now?' (No), 'ur spine for scoliosis?' (Yes), 'Have you ever fractured your hip, had a hip replacement, or do you have a pin in your hip?' (Yes), and 'Is it your right hip, left hip, or both?' (Left).

**Exhibit 4-16. Scan left hip message**

The screenshot shows a software interface with a warning dialog box and a data entry form. The dialog box, titled 'DXA', contains a red 'X' icon and the text 'Proceed with femur scan on left hip for safety reasons.' with an 'OK' button. The background form includes several dropdown menus: 'ostomy or colostomy?' (No), 'ng a hearing aid now?' (No), 'ur spine for scoliosis?' (No), 'Have you ever fractured your hip, had a hip replacement, or do you have a pin in your hip?' (Yes), and 'Is it your right hip, left hip, or both?' (Right).

## 4.4 DXA Whole Body Data Capture Screen

Exhibit 4-17 is the ISIS Whole Body data capture screen. This screen allows you to check whether the scan was completed after answering the reflection positioning question.

**Exhibit 4-17. Whole body data capture (1)**

Body Composition Exam Subsystem Stand615 Session615810 11/15/2010 08:30 am - 12:30 pm

DXA: Stand615 Session615810 11/15/2010 08:30 am - 12:30 pm

SP ID: 745052 Name: EVANS, SAVANNAH M Age: 41 years Gender: Female Date: 12/10/2012 Time: 02:03 PM

DXA Data Capture

**Whole Body Scan**

Is reflection positioning required?  Yes  No

Scan completed?  Yes  No

Comment on scan Check all that apply:

- SP movement during exam
- Positioning problem
- Jewelry or other objects not removed
- Hands positioned along sides, not flat
- Pillow used for head support
- Too tall for table, feet out of scan
- Equipment failure
- Reflection used during the whole body scan
- Less than 6 inches of clearance

Other:

Archive File name:

BMI: 23

Ready | MEC Layer: 9/12/2012 | Application: 10.2.2 | Not connected to Coordinator | 02:05 PM

If reflection positioning is required, a message will appear to select the high-power option. See Exhibit 4-18.



Exhibit 4-18. Whole body data capture with reflection positioning

**Whole Body Scan**

Is reflection positioning required?  Yes  No

Scan completed:  Yes  No

Comment on scan Check all that apply:

SP movement during exam

Equipment failure

Reflection used during the whole body scan

Less than 6 inches of clearance

Other:

DXA Please select the HP Whole Body Scan. OK

Click OK and complete the scan. The screen has checkboxes to record any problems in getting a good quality scan. You can check one or more of the following problems:

- SP movement during the exam;
- Positioning problem;
- Jewelry or other objects not removed;
- Hands positioned along sides, not flat;
- Too tall for table, feet out of scan;
- Pillow used for head support;
- Equipment failure;
- Reflection used during the whole body scan;
- Less than 6 inches of clearance (enabled for SPs selected for high-power option); or
- Other (specify).

If the scan is completed, select “Yes.” See Exhibit 4-19.

Exhibit 4-19. DXA data capture (2)

**Whole Body Scan**

Is reflection positioning required?  Yes  No

Scan completed:  Yes  No

Comment on scan Check all that apply:

- SP movement during exam
- Positioning problem
- Jewelry or other objects not removed
- Hands positioned along sides, not flat
- Pillow used for head support
- Too tall for table, feet cut out of scan
- Equipment failure
- Reflection used during the whole body scan
- Less than 6 inches of clearance

Other:

Archive File name: D12101200.ARC

BMI: 23

The system will automatically enter the Archive File name. The Archive number is D for DXA, 121012 for December 10, 2012, and 00 for the first file to be archived. The file extension is .ARC.

During and immediately after the scan, check the scan for quality. See Exhibit 4-20. Check all comments that apply.

Exhibit 4-20. DXA data capture (comments on scan)

Body Composition Exam Subsystem: Stand615 Session615810 11/15/2010 08:30 am - 12:30 pm

DXA: Stand615 Session615810 11/15/2010 08:30 am - 12:30 pm

SP ID: 745052 Name: EVANS, SAVANNAH M Age: 41 years Gender: Female Date: 12/10/2012 Time: 02:03 PM

DXA Data Capture

**Whole Body Scan**

Is reflection positioning required?  Yes  No

Scan completed:  Yes  No

Comment on scan Check all that apply:

- SP movement during exam
- Positioning problem
- Jewelry or other objects not removed
- Hands positioned along sides, not flat
- Pillow used for head support
- Too tall for table, feet cut out of scan
- Equipment failure
- Reflection used during the whole body scan
- Less than 6 inches of clearance

Other:

Archive File name: D12101200.ARC  
BMI: 23

Ready | MEC Layer: 9/12/2012 | Application: 10.2.2 | Not connected to Coordinator | 02:08 PM

If the DXA scan cannot be completed, select “No.” See Exhibit 4-21 (DXA Component Status). If the reason is equipment failure, check that comment. If there is another reason, enter the reason in the free text box for “Other.”

If the scan cannot be completed, the DXA component status will be set to “Not Done.” Select the appropriate comment from the list in the drop-down menu. See Exhibit 4-21.

Exhibit 4-21. DXA data capture (scan not completed)

Body Composition Exam Subsystem: Stand615 Sessions615810 11/15/2010 08:30 am - 12:30 pm

DXA: Stand615 Sessions615810 11/15/2010 08:30 am - 12:30 pm

SP ID: 745052 Name: EVANS, SAVANNAH M Age: 41 years Gender: Female Date: 12/10/2012 Time: 02:03 PM

DXA Data Capture

**Whole Body Scan**

Is reflection positioning required?  Yes  No

Scan completed:  Yes  No

Comment on scan Check all that apply:

- SP movement during exam
- Positioning problem
- Jewelry or other objects not removed
- Hands positioned along sides, not flat
- Pillow used for head support
- Too tall for table, feet out of scan
- Equipment failure
- Reflection used during the whole body scan
- Less than 6 inches of clearance

Other:

Archive File name:  
BMI: 23

Ready | MEC Layer: 9/12/2012 | Application: 10.2.2 | Not connected to Coordinator | 02:09 PM

If the SP has been selected for the high-power whole body scan, a message will display in the Whole Body Data Capture screen. See Exhibit 4-22.

**Exhibit 4-22. High-power (HP) message box**

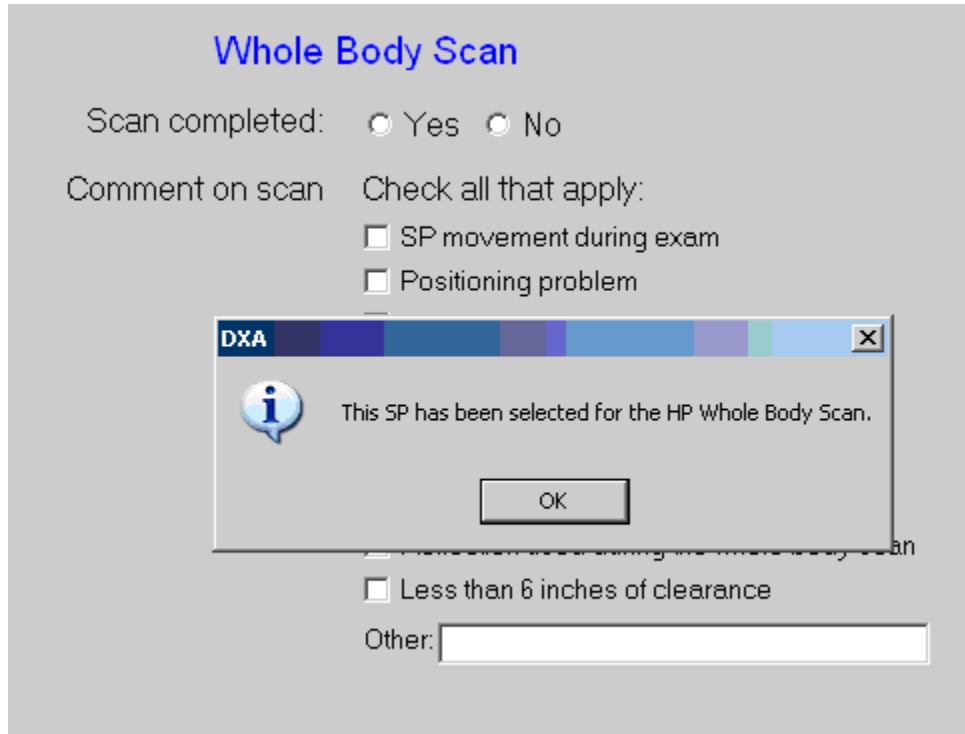

If the SP has been selected for the HP whole body scan and the HP option was not used, an error message will display. See Exhibit 4-23.

**Exhibit 4-23. HP error message**

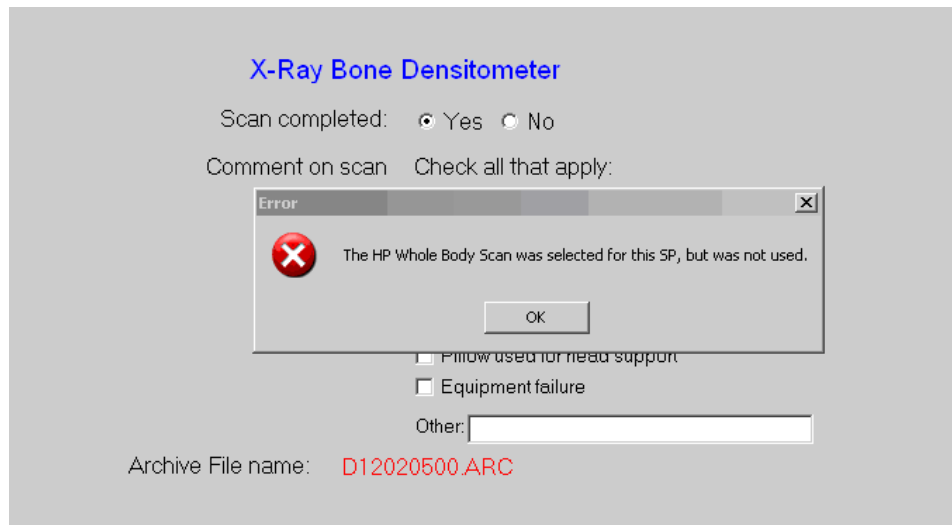

## 4.5 DXA Proximal Femur Data Capture Screens

Exhibit 4-24 is the ISIS DXA data capture screen for the femur scan. This screen allows you to check whether the femur scan was completed.

**Exhibit 4-24. DXA data capture (femur scan)**

Body Composition Exam Subsystem: Stand:615 Session:615810 11/15/2010 08:30 am - 12:30 pm

File View Utilities Reports Window Help

DXA: Stand:615 Session:615810 11/15/2010 08:30 am - 12:30 pm

SP ID: 745052 Name: EVANS, SAVANNAH M Age: 41 years Gender: Female Date: 12/05/2012 Time: 03:20 PM

Femur Scan

Proximal Femur

Scan completed:  Yes  No

Comment on scan

Check all that apply:

SP movement during exam

Positioning problem

Jewelry or other objects not removed

Objects not removed

Equipment failure

Other:

Archive File name:

End of Section Close Exam Finish

Ready MEC Layer: 9/12/2012 Application: 10.2.2 Not connected to Coordinator 03:31 PM

Start Body Composition Ex...

There are no defaults on the screen when it is first displayed. This screen has check boxes to record any problems in getting a good quality femur scan. You can check one or more of the following problems:

- SP movement during the exam;
- Positioning problem;
- Jewelry or other objects not removed;

- Objects not removed;
- Equipment failure; or
- Other—open text box.

If the scan is completed, select “Yes.” See Exhibit 4-25. The system will automatically enter the Femur Archive file name.

**Exhibit 4-25. DXA data capture (femur scan) Femur Archive file name**

**Proximal Femur**

Scan completed:  Yes  No

Comment on scan Check all that apply:

- SP movement during exam
- Positioning problem
- Jewelry or other objects not removed
- Objects not removed
- Equipment failure

Other:

Archive File name: **D12101200.ARC**

The Archive number is D for DXA, 121012 for December 10, 2012, and 00 for the first file to be archived. The file extension is .ARC. During and immediately after the scan, check the scan for quality. If one or more of the Comments on the scan apply, check all that apply.

If the scan cannot be completed, select “No.” See Exhibit 4-26. If the reason is equipment failure, check that comment. If there is another reason, enter the reason in the free text box for Other.

Exhibit 4-26. DXA data capture (femur scan)

**Proximal Femur**

Scan completed:  Yes  No

Comment on scan Check all that apply:

- SP movement during exam
- Positioning problem
- Jewelry or other objects not removed
- Objects not removed
- Equipment failure

Other:

Archive File name:

Press Enter to proceed to the anteroposterior (AP) Lumbar Spine screen.



## 4.6 DXA AP Lumbar Spine Scan Data Capture Screens

Exhibit 4-27 is the ISIS DXA data capture screen for the AP spine scan. This screen allows you to check whether the AP spine scan was completed.

**Exhibit 4-27. DXA data capture (AP spine scan)**

Body Composition Exam Subsystem: Stand:615 Session:615810 11/15/2010 08:30 am - 12:30 pm

DXA: Stand:615 Session:615810 11/15/2010 08:30 am - 12:30 pm

SP ID: 745052 Name: EVANS, SAVANNAH M Age: 41 years Gender: Female Date: 12/05/2012 Time: 03:20 PM

Spine Scan

**AP Lumbar Spine**

Scan completed:  Yes  No

Comment on scan Check all that apply:

SP movement during exam

Positioning problem

Jewelry or other objects not removed

Objects not removed

Equipment failure

Other:

Archive File name:

End of Section Close Exam Finish

Ready MEC Layer: 9/12/2012 Application: 10.2.2 Not connected to Coordinator 03:31 PM

There are no defaults on the screen when it is first displayed. This screen has check boxes to record any problems in getting a good quality AP spine scan. You can check one or more of the following problems.

- SP movement during the exam;
- Positioning problem;
- Jewelry or other objects not removed;

- Objects not removed;
- Equipment failure; or
- Other—open text box.

If the scan is completed, select “Yes.” See Exhibit 4-28. The system will automatically enter the AP Spine Archive file name.

**Exhibit 4-28. DXA data capture (AP spine scan) AP Spine Archive file name**

**AP Lumbar Spine**

Scan completed:  Yes  No

Comment on scan Check all that apply:

- SP movement during exam
- Positioning problem
- Jewelry or other objects not removed
- Objects not removed
- Equipment failure

Other:

Archive File name: **D12101200.ARC**

The Archive number is D for DXA, 121012 for December 10, 2012, and 00 for the first file to be archived. The file extension is .ARC. During and immediately after the scan, check the scan for quality. If one or more of the comments on the scan apply, check all that apply.

If the scan cannot be completed, select “No.” See Exhibit 4-29. If the reason is equipment failure, check that comment. If there is another reason, either check the appropriate box or enter the reason in the free text box for Other. Press Enter to proceed to the instant vertebral assessment (IVA) AP Spine Scan screen.

Exhibit 4-29. DXA data capture (AP spine scan)

AP Lumbar Spine

Scan completed:     Yes     No

Comment on scan    Check all that apply:

SP movement during exam

Positioning problem

Jewelry or other objects not removed

Objects not removed

Equipment failure

Other:

## 4.7 DXA Component Status

The completion status for the DXA component is any of the following:

- |                   |   |  |
|-------------------|---|--|
| ■ <b>Complete</b> | Ages 8 – 49 years<br>Ages 50 – 59 years<br>Ages 60+ | Whole body scan completed<br>Whole body, femur, and lumbar spine completed<br>Femur and lumbar spine completed   |
| ■ <b>Partial</b>  | Ages 8 – 49 years<br>Ages 50 – 59 years<br>Ages 60+ | Shared and safety exclusion status completed, but whole body scan interrupted or not completed<br>Shared and safety exclusion status completed, but whole body scan, femur, lumbar spine interrupted or not completed<br>Shared and safety exclusion status completed, but femur and lumbar spine interrupted or not completed |
| ■ <b>Not Done</b> | Ages 8 – 49 years                                   | Shared and safety exclusion questions not completed, and whole body not completed  |

Ages 50 – 59 years	Shared and safety exclusion status completed, but whole body scan, femur, lumbar spine interrupted or not completed
Ages 60+	Shared and safety exclusion questions not completed, and femur and lumbar spine interrupted or not completed

If a comment is not selected when the status is “Partial” or “Not Done,” a message will be displayed: “Please select comments.” See Exhibit 4-30.

Click OK to this message and select the appropriate comment. Press the Finish button to end the exam.

#### Exhibit 4-30. DXA component status (required comments)

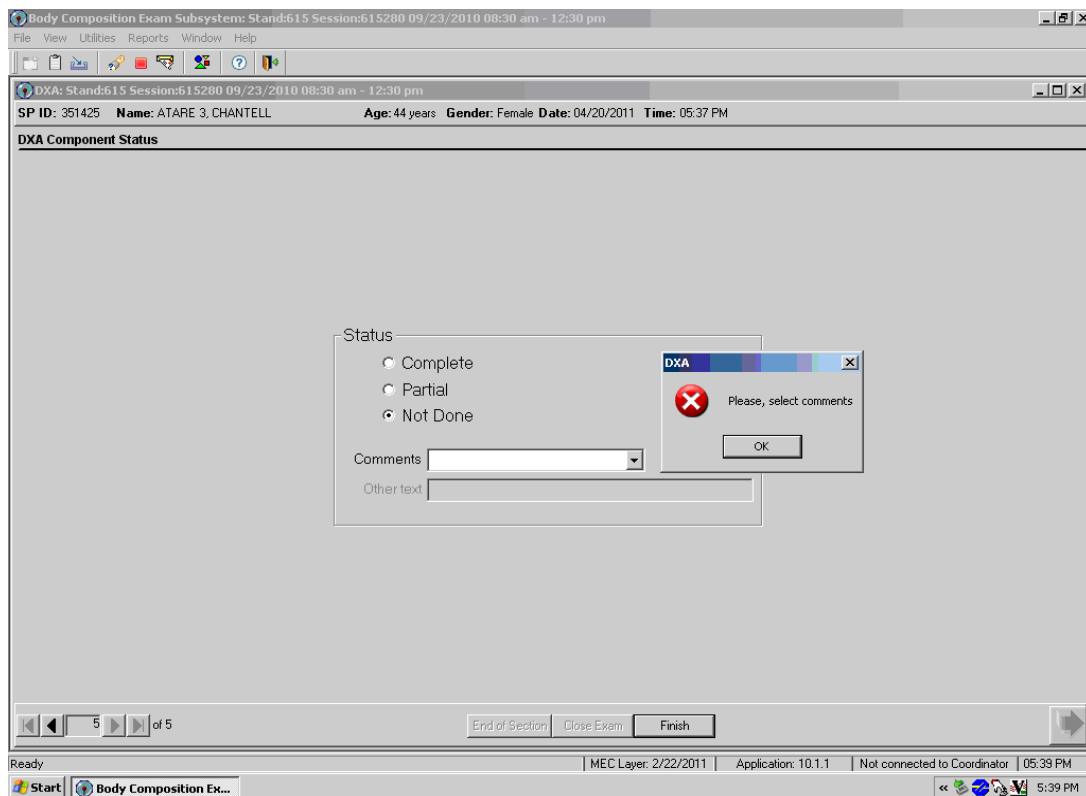

If the component status is “Partial” or “Not Done,” the system will require a comment to be selected from the drop-down menu. See Exhibit 4-31.

**Exhibit 4-31. DXA component status**

Body Composition Exam Subsystem: Stand:615 Session:615280 09/23/2010 08:30 am - 12:30 pm

DXA: Stand:615 Session:615280 09/23/2010 08:30 am - 12:30 pm

SP ID: 351425 Name: ATARE 3, CHANTELL Age: 44 years Gender: Female Date: 04/20/2011 Time: 05:37 PM

**DXA Component Status**

Status

Complete

Partial

Not Done

Comments inability to lie still

Other text Data effect

equipment failure

Error (technician/software/supp

inability to lie still

interrupted

Language Barrier

End of Section Close Exam Finish

Ready MEC Layer: 2/22/2011 Application: 10.1.1 Not connected to Coordinator 05:40 PM

Start Body Composition Ex... 5:41 PM

The comments in the drop-down box are the following:

- Data effect;
- Equipment failure;
- Error (technician/software/supplies);
- Inability to lie still;
- Interrupted; and
- Language barrier.

Other comments in the drop-down box that are not shown in Exhibit 4-22 are the following:

- Awaiting pregnancy result;
- Communication problem;
- No time;
- Other (specify);
- Pain or discomfort;
- Physical limitation;
- Proxy, no information;
- Safety exclusion;
- SP did not change clothes;
- SP ill/emergency;
- SP moved during the procedure;
- SP pregnant;
- SP refusal;
- SP unable to comply;
- Urine not collected;
- Weight limitation on equipment; and
- Exceeds height limitation.

## 4.8 Session Pickup List

- The Session Pickup List box can be accessed from the Toolbar under Reports.
- Go to Reports and select Session Pickup from the menu.
- A list of current sessions will be displayed. See Exhibit 4-32.

Exhibit 4-32. Session pickup list

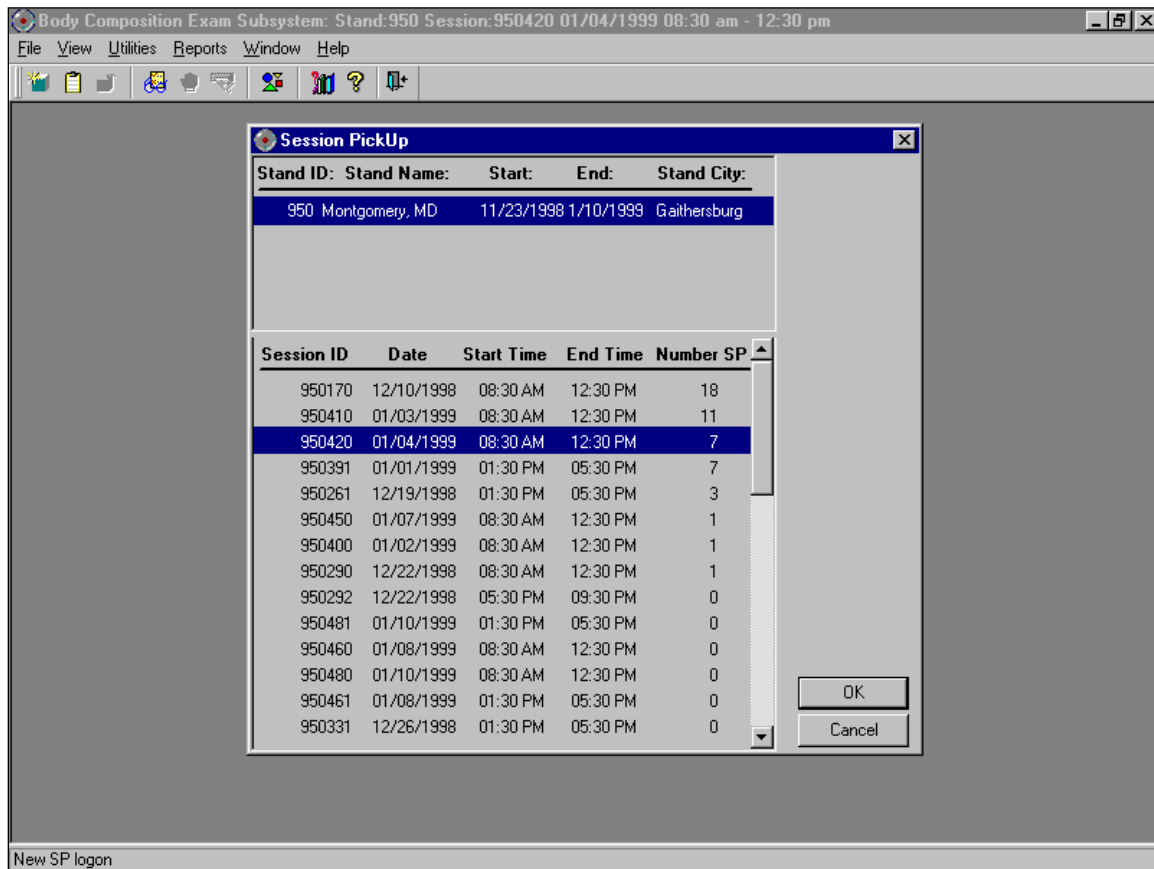

## 4.9 Session Preview Report

- The Session Preview Report can be accessed from the Toolbar under Reports.
- Go to Reports and select Session Preview from the menu.
- The list of SPs in the current session is displayed. The SP identification number, the type (primary, guest, replicate), name, age, gender, special considerations, and comments are displayed (see Exhibit 4-33).

Exhibit 4-33. Session preview report

SP ID	SP Type	SP Name	Age	Gender	Special Considerations	Consent Comments
256998	Primary	Cynthia Driver	28 years	Female		
860557	Primary	Joan Hemming	55 years	Female		
427820	Primary	Perry Parker	44 years	Male		
177687	Primary	Jack Ruby	44 years	Male		
572165	Primary	Kevin Singleton	33 years	Male		
971761	Primary	Shiela White	38 years	Female		
238554	Primary	Mike Young	18 years	Male		



## 4.10 Room Log

- The Room Log can be accessed from the Toolbar under Reports.
- Go to Reports and select Room Log from the menu.
- A list of the SPs eligible for this component is displayed.
- The SP ID, name, sex, age, SP status, and component status are displayed. See Exhibit 4-34.

Exhibit 4-34. Room log for body composition

**Body Composition Room Log** 12/18/1998 08:30 AM  
Stand: 950

Session: 9500034 12/10/1998 08:30 AM - 12:30 PM Total: 14 SPs

SP ID	SP Name	Gender	Age	SP Status	Component Status
895839	Robin Smith	Male	16		
179292	Charles Kennedy	Male	70		
383612	Patricia Davis	Female	70		
286748	Larry Davis	Male	75		
395452	Mary Matthews	Male	75		
767202	Bob Matthews	Male	72		
211957	Kate Kennedy	Female	28	3	required
140261	Mark Urgo	Male	12	3	complete
932431	Rita Rodgers	Female	29	3	complete
266994	Walter Rodgers	Male	70	3	complete
460247	Clare Urgo	Female	32		not done
668791	Jessica Jackson-smith	Female	33		not done
358087	John Jackson	Male	73		not done
362728	Rosamund Smith	Female	19	3	not done

Page 1 of 1

## 4.11 Close Exam

Any exam may be terminated at any point during the exam (SP becomes ill, changes his or her mind about completing the test). See Exhibit 4-35. The “Close Exam” button is used to end the exam abruptly without going through the remaining screens. Choose a comment and click on “Close” to end the exam.

**Exhibit 4-35. Close exam**

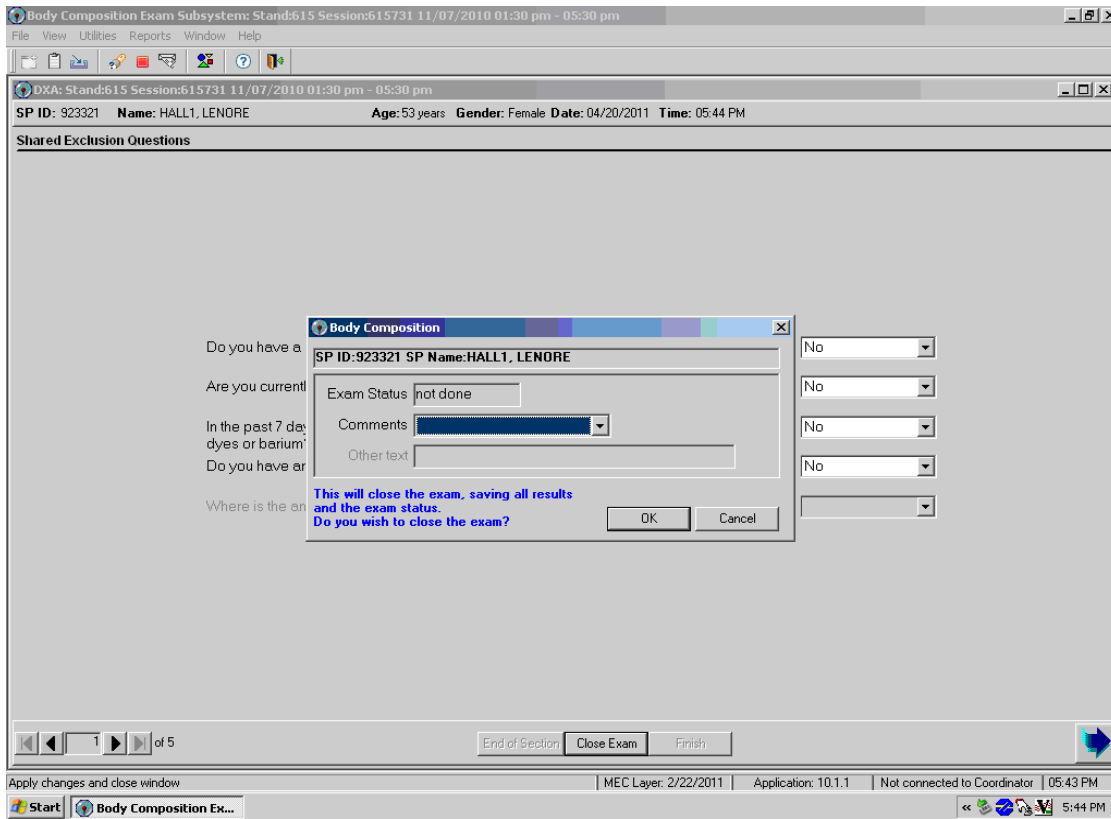

## Referrals and Report of Findings

### 5.1 Observation Referrals

Observation referrals are nonemergency situations that may arise in any of the examination rooms in the MEC. Technologists may send an observation referral to the MEC physician if they notice any condition that may be abnormal or that may warrant further assessment. This type of referral may be sent at any time from any of the exam rooms. The referral may or may not have anything to do with the current exam being performed.

Once a technologist sends a referral to the physician, the ISIS system will flag the referral for the SP in the Physician Referral Review box. The SP will not be checked out of the MEC until the physician has reviewed this referral. The physician will make a decision whether further action is warranted and whether a physician referral to the SP's health care provider should be given to the SP.

- Observation referrals can be sent during the exam or after the exam has been closed;
- Under Utilities, select "Observations" (Exhibit 5-1). If an exam is already opened, the Observation referral box for that SP will be displayed.

**Exhibit 5-1.** Menu to select observation referral

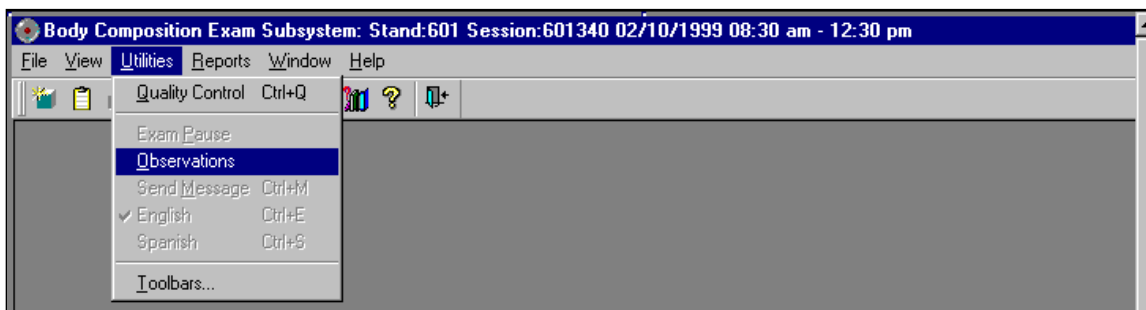

If the exam has been closed, a pick list with the names of the SPs in the current session will be displayed. (This list is only displayed if Utilities/Observations is selected when an exam is not open.) See Exhibit 5-2.

Exhibit 5-2. Pick list of SPs in current session

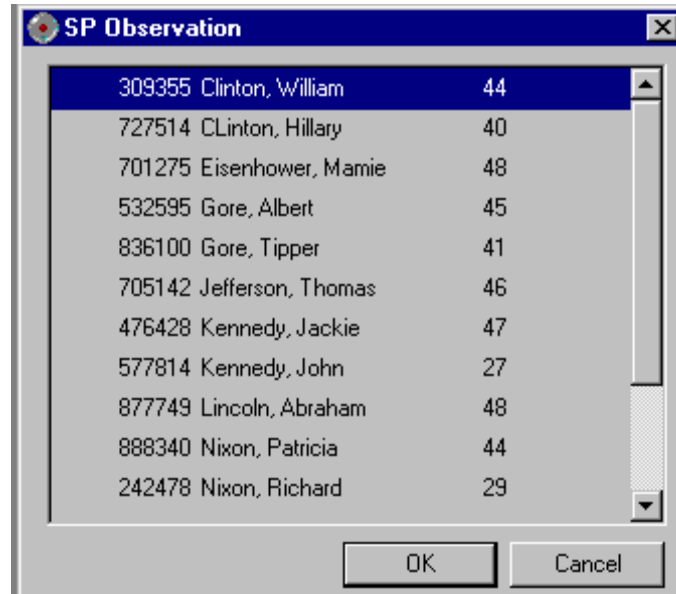

Select the name of the SP for whom an observation referral should be sent. Click OK. Exhibit 5-3 presents an example of a message to a physician.

Exhibit 5-3. Observation referral in body composition

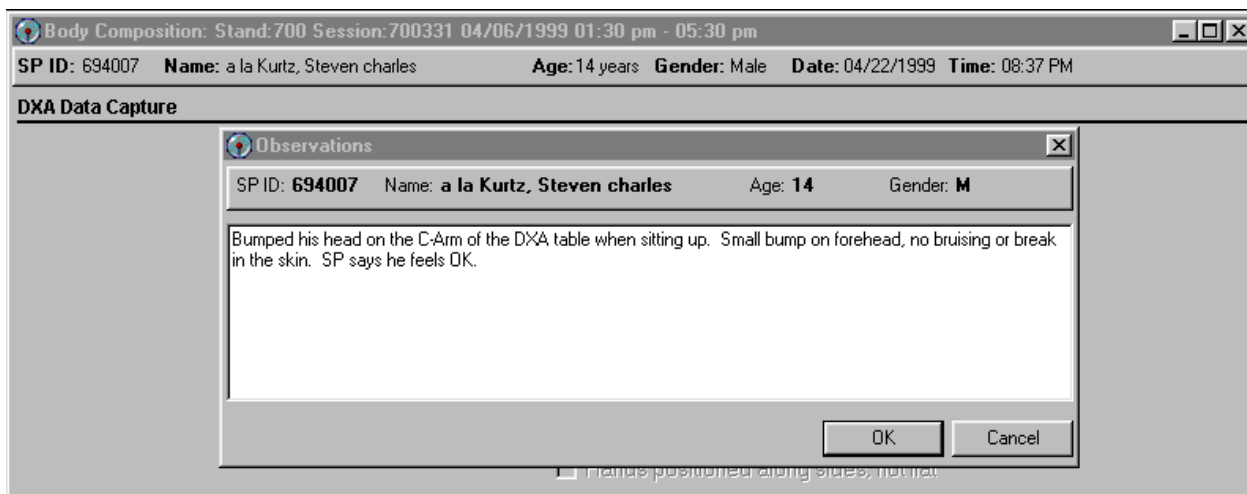

Type in the message you would like to send to the physician. When you are finished, click OK. See Exhibit 5-4.

Exhibit 5-4 shows the referral as it appears in the Physician's Referral Review box. The message typed in the Observation Referral box in body composition appears in this box in the Physician

Referral Review. The physician will review this referral and make a decision about further action if warranted; and the SP cannot be checked out of the MEC until the physician has reviewed this referral.

**Exhibit 5-4. Observation referral from other components in physician's referral review box**

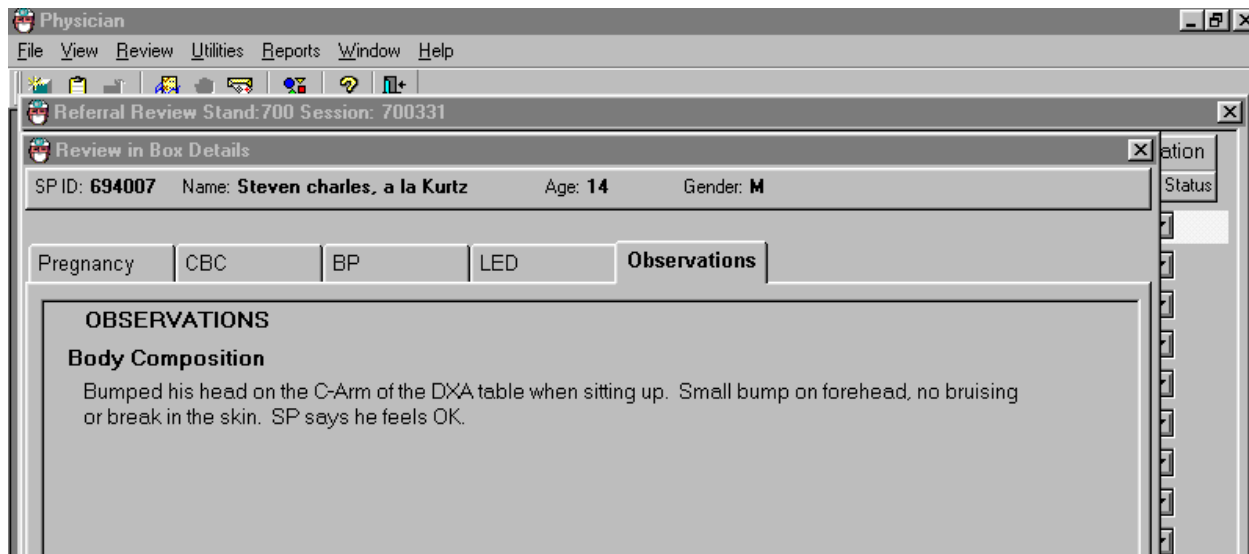

## 5.2 Report of Findings for DXA

Each SP will be given a report of the results or findings for the scans performed. The Report of Findings for the DXA whole body exam will include a report on the total percent body fat and total bone mineral density (BMD).

Results will be included in the final Report of Findings sent from NCHS. Participants who are 8 through 59 years of age will receive a Report of Findings on their whole body, and participants ages 50 and above will receive a Report of Findings on their AP lumbar spine scan, and femur scan. Participants less than 8 years and greater than 59 years will not have a whole body scan so there will be no results on this scan for this age group, and participants under the age of 50 will not have any spine or femur scans so they will not receive BMD.

The variables reported for the whole body scan will be total percent body fat. A statement is included informing participants that it is not currently known what percent body fat is considered a healthy range for the public. Participants are told that researchers are working to define this range

and participants are advised to discuss the results with their health care provider to find out more about what the results mean on an individual basis.

## 5.2.1 Sample Preliminary Report of Findings

Refer to Exhibit 5-5 for a sample of a preliminary Report of Findings.

### Exhibit 5-5. Sample report of findings for body composition

**Body Composition and Bone Health**

The whole body scan provides information on your percent body fat.

The body composition exam results showed that your total body fat is 24.9%.

We do not know exactly what percent body fat is considered healthy for your age and gender. Researchers are working to define the healthy ranges for the public. You may want to discuss this result and your body measurement findings (page 1) with your doctor to find out what they mean for you. Too much body fat can increase a person's risk of getting diabetes or heart disease.

The bone density measurement can help spot persons who may be at greater risk for fracture because they have weaker bones. In general, a lower bone density means that the bone is weaker. Yet, not all men or women with low bone density will have fractures.

The results from your hip (left or right) scan show:

Hip bone density	0.5680 g/cm <sup>2</sup>
T-score	-2.50

Based on diagnostic criteria as recommended by the World Health Organization and the International Society of Clinical Densitometry (1,2), your hip bone density is **very low**.

The results from your spine (lumbar) scan show:

Spine bone density	0.8440 g/cm <sup>2</sup>
T-score	-1.80

Based on diagnostic criteria as recommended by the World Health Organization and the International Society of Clinical Densitometry (1,2), your spine bone density is **low**.

Most people develop low bone density over many years. We recommend you discuss these results with your doctor as soon as possible, since fractures due to osteoporosis often occur at sites with very low bone density. Your doctor can review your diet and lifestyle and tell you what you can do to prevent more bone loss.

1. Kanis J, Melton LJ, Christiansen C, Johnstron C, Khaltaev N. The diagnosis of osteoporosis. *J Bone Mineral Research* 1994;9:1137-1141. [http://onlinelibrary.wiley.com/journal/10.1002/\(ISSN\)1523-4681](http://onlinelibrary.wiley.com/journal/10.1002/(ISSN)1523-4681)

2. International Society for Clinical Densitometry. Official positions 2015 Adult and pediatric. Middletown CT <http://www.iscd.org/official-positions/2015-iscd-official-positions-adult/>

## 6.1 Equipment and Room Setup Checks

The equipment, room supplies, and room setup need to be checked on a regular basis. Some checks are completed daily and others need only be completed on a weekly basis or at the beginning of each stand. These checks include calibration checks, maintenance inspection of equipment and supplies, and preparation of the room and equipment for the session exams.

Each time you log onto the application, the system will remind you to do quality control (QC) checks if the checks have not been completed for that time period. The checks are to be completed daily, weekly, three times a week, and/or every stand. If you do not have time to do the checks when you log on, you can bypass this message and complete the checks later. However, this message will be displayed each time you log on until you have completed the checks for that time period. Once you have completed the checks and entered this in the system, the message box with the reminder will not be displayed again until the appropriate time period has passed.

An exception to the above is the QC check with the Hologic Anthropomorphic Spine Phantom. This spine phantom must be scanned daily to confirm the calibration of the densitometer before the densitometer will allow scans to be completed. If an attempt is made to perform a scan before the daily QC is completed, an error message will be displayed. Press Enter at this message and complete the spine phantom calibration.

The daily, three times a week, weekly, and once-a-stand checks are listed in the following sections.

### 6.1.1 Daily

- One spine phantom: Hologic Anthropomorphic Spine Phantom (HASP).
- Check that table scan area is clear of articles that might interfere with table movement.
- Check runner area of table to confirm the area is clear of articles that might interfere with table movement.

### 6.1.2 Three Times Per Week (1st, 3rd, and 5th days of work week)

- Complete all daily checks.
  - One Spine Phantom.
  - One Slim-Line Whole Body Phantom.

### 6.1.3 Weekly

- Complete all daily checks.
  - One Spine Phantom.
- Complete the “three times weekly” scans.
  - One Slim-Line Whole Body Phantom.
- One Radiographic Uniformity.
- One Step Phantom.
- One Femur Phantom.

### 6.1.4 Start of Stand

- Check that the locking pins have been removed before attempting to complete any scans.
- One Spine Phantom.
- One Step Phantom.
- One Radiographic Uniformity.
- Five Slim-Line Whole Body Phantom.
- Five Femur Phantoms.
- DXA:
  - Ten circulating spine phantoms (HSP-Q-96).  
**Only at the first stand of the year for each MEC.**



- Ten circulating block phantoms (NH #1).  
**Only at the first stand of the year for each MEC.**
- Five Hologic Whole Body Phantoms (HWBP) (WB Phantom #008).  
**Only at the first stand of the year for each MEC.**

### 6.1.5 End of Stand

Clean DXA table with a very dilute solution of Ivory dishwashing detergent.

## 6.2 Procedures for Completing QC Scans

### 6.2.1 Hologic Anthropomorphic Spine Phantom (HASP)

In the Discovery main menu (Exhibit 6-1), click on the Daily QC button. Alternatively, Daily QC can be selected from the QC pull-down menu in the main menu to start the procedure.

Exhibit 6-1. Discovery main menu



The system displays the Daily QC Setup window, prompting the placement of the Spine Phantom on the table. See Exhibit 6-2.

**Exhibit 6-2. Daily QC setup box**

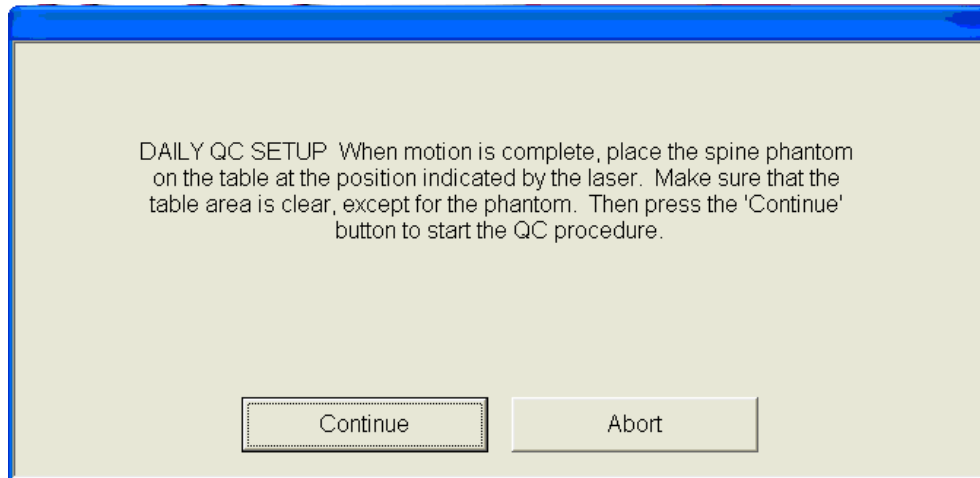

When the table motion is complete, place the spine phantom on the table with the registration mark (see A in Figure 6-1) to the left foot end. Position the phantom parallel to the back of the table.

Align the laser crosshair (see B in Figure 6-2) with the registration mark. Once the spine is properly positioned, click the Continue button. *The System starts performing an automatic test.*

Figure 6-1. Spine phantom registration mark

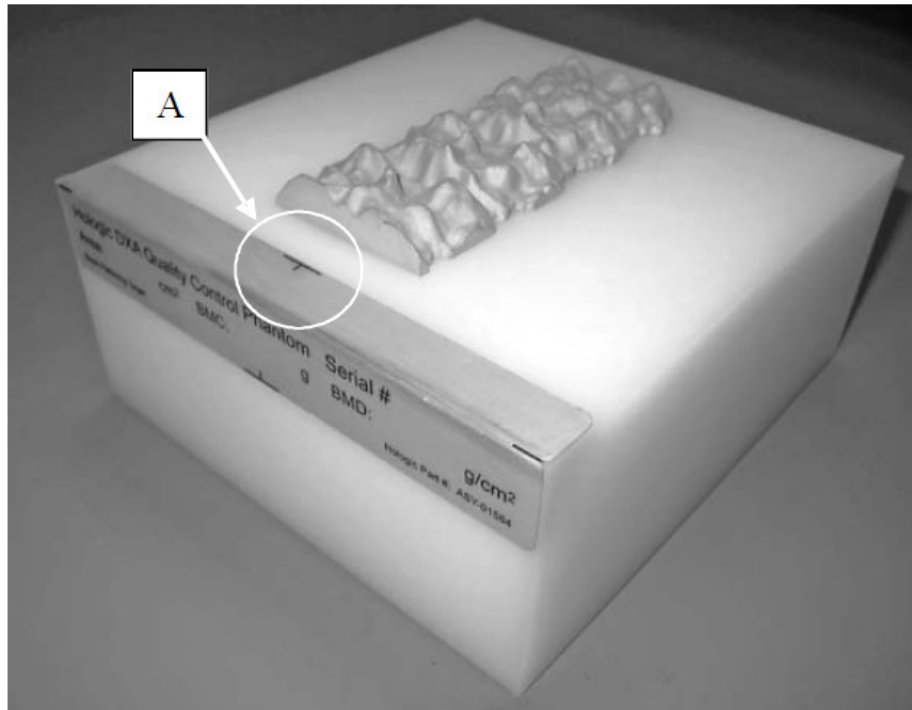
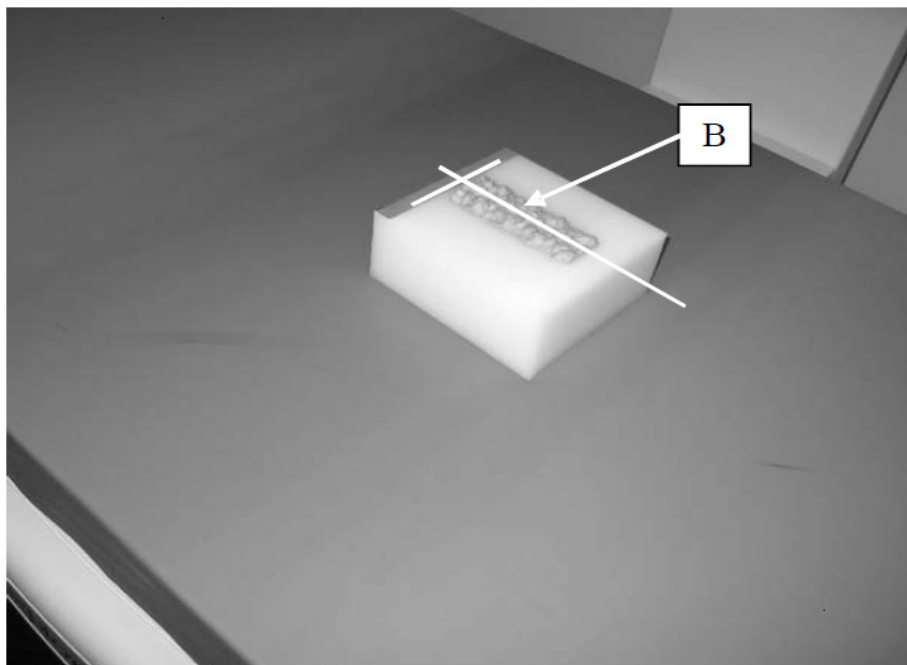
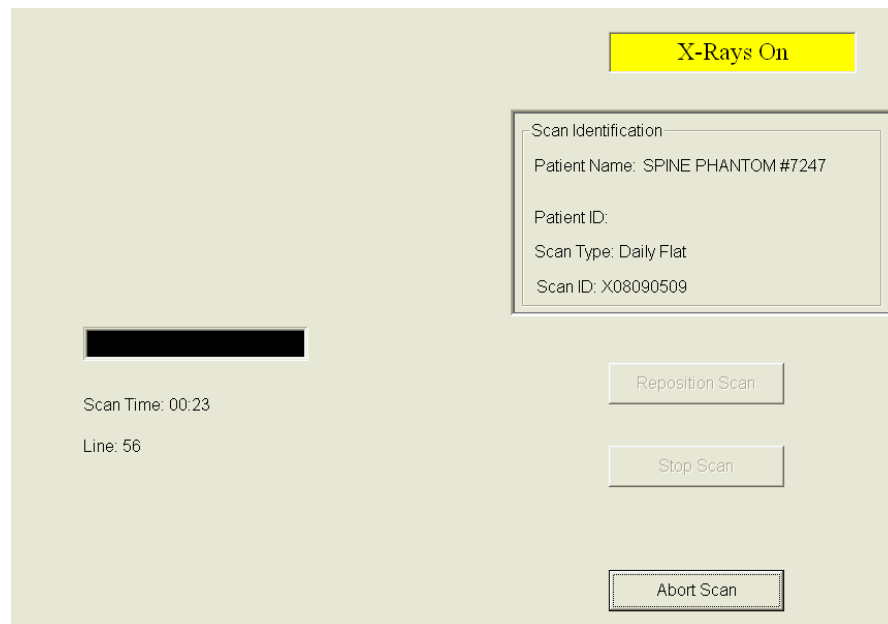

Figure 6-2. Spine phantom and laser crosshair position



The Discovery A system automatically performs a system test to verify proper operation of its X-ray subsystem prior to scanning the spine phantom. The following screen, Exhibit 6-3, is displayed during the system test.

**Exhibit 6-3. System self-test**



If the automatic system test succeeds, a message appears on the screen indicating that the system test passed. See Exhibit 6-4.

**Exhibit 6-4. System test passed**

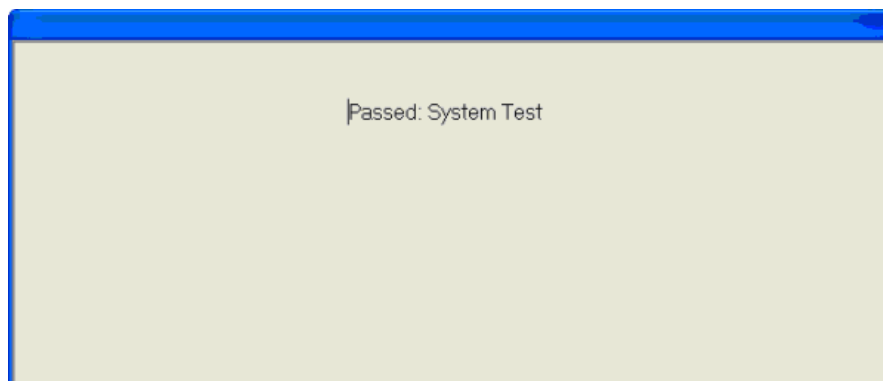

If the automatic system test fails, the system displays a message stating that the test failed, and with information on how to correct the error. Upon successful completion of the system test, the system runs Auto QC. When Auto QC has been completed, a window appears giving either a passed or failed message.. See Exhibit 6-5.

**Exhibit 6-5. Auto QC passed**

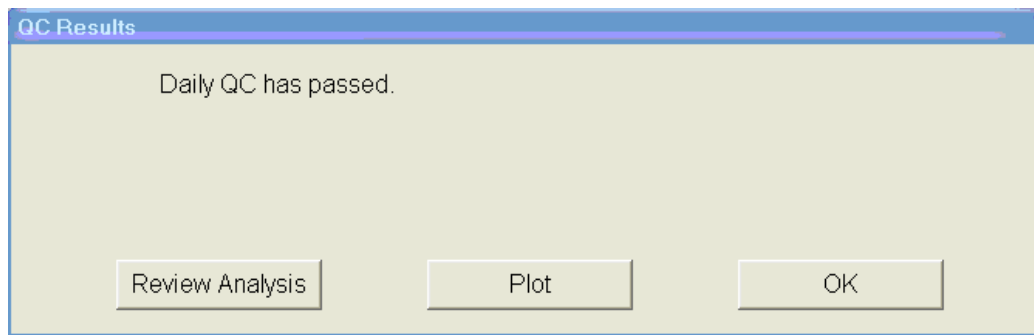

**6.2.1.1 Checking Bone Mineral Density (BMD) and Bone Mineral Content (BMC)**

To review the QC plot, click on the PLOT button from the QC Results window for a passed Auto QC. (See Exhibit 6-4 shown earlier.) The QC Plot window appears. Check the BMD graph for the circle for that day's scan (at far right side of graph). See Exhibit 6-6.

Exhibit 6-6. Spine Phantom QC—plot for bone mineral density (BMD)

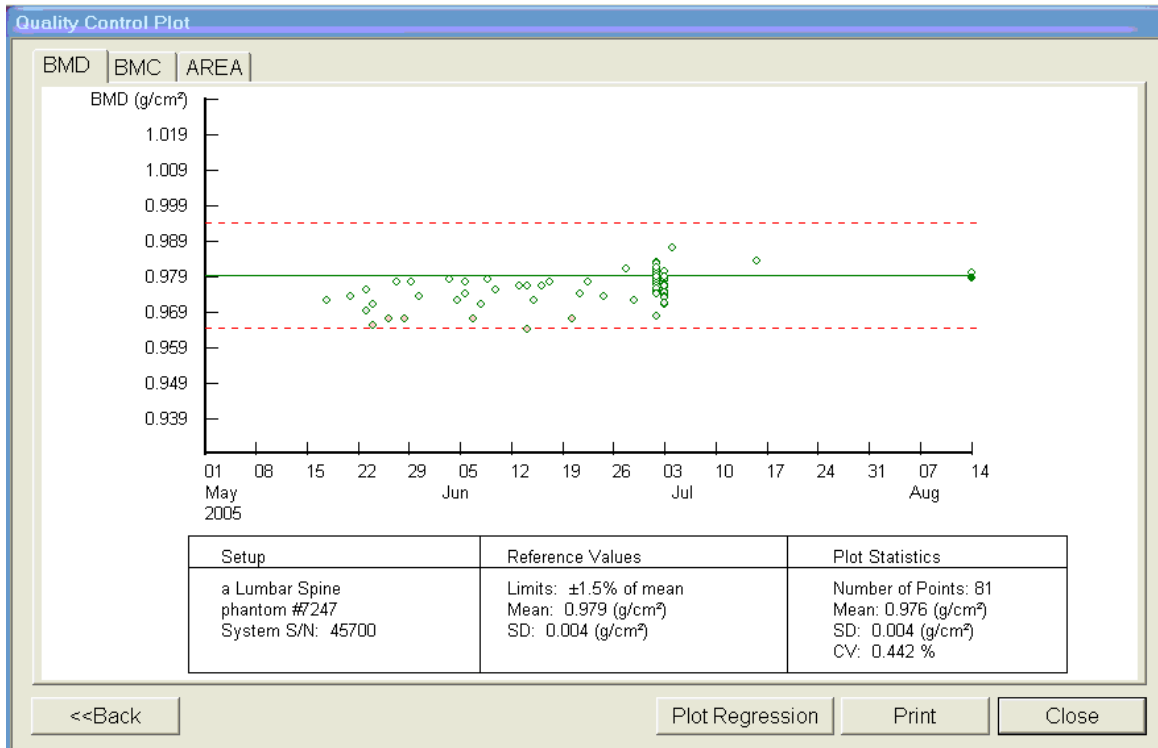

- The circle should be within the two dotted lines.
- The coefficient of variation (CV) for BMD should be at or below 0.6 percent.
- If the circle is not within the dotted lines or the CV is greater than 0.6 percent, see directions in Section 6.2.1.2.
- To check the bone mineral content (BMC), select the BMC tab at the top of the screen by clicking on it.
- Check the BMC graph for the circle for that day's scan (at the far right side of the graph). See Exhibit 6-7.

Exhibit 6-7. Spine phantom QC—plot for bone mineral content (BMC)

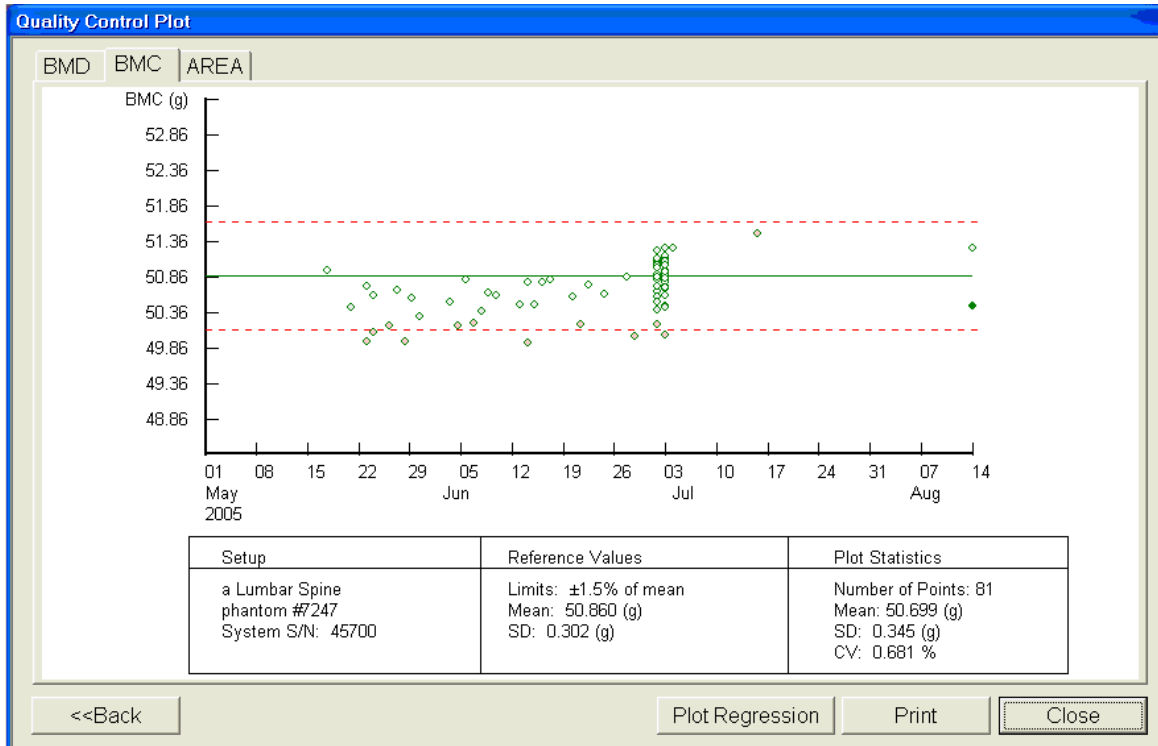

- The circle should be within the two dotted lines.
- The coefficient of variation (CV) for BMC should be at or below 0.80 percent.
- If the circle is not within the dotted lines or the CV for BMC is greater than 0.80 percent, see directions in Section 6.2.1.2.
- If the circle is within the dotted lines and the CV for BMC is at or below 0.80 percent, press BACK to return to the Auto QC passed window or CLOSE to return to the system main menu.
- Read the messages on the Hologic computer screen. If the step phantom hasn't been scanned in the past week, a message will be displayed stating that it should be scanned following the spine phantom scan. (See Exhibit 6-8.)

### 6.2.1.2 Auto QC Failure

If Auto QC fails, the message is "Daily QC failed" and a series of steps is provided. The QC Results Window contains four buttons: Details, Review Analysis, Plot, and OK. Clicking Details provides additional information about the QC failure. Click OK to return to the system main menu so Daily QC can be re-run.

If after two attempts, the Daily QC continues to fail, report this to the Component Lead Health Technologist (CLHT) AND the MEC manager. This information must be reported to Hologic. The CLHT should make the call to Hologic, but may delegate this responsibility to the MEC manager if the session is busy. Record this call on the “Hologic Call Log” and stop all scans until further notice from the Hologic technician.

## 6.2.2 Step Phantom

Select QC from the top menu bar in the Discovery Main Menu (see Exhibit 6-1 shown earlier) and select Step Phantom from the drop-down menu. A message box will prompt the setup of the Step Phantom QC. See Exhibit 6-8.

**Exhibit 6-8. Step phantom setup window**

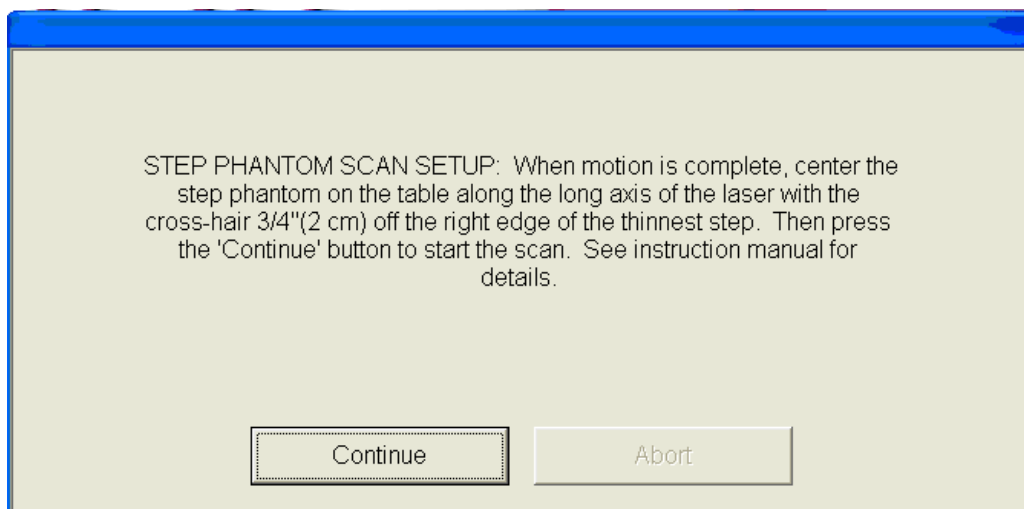

When the table motion is complete, place the body composition phantom lengthwise on the table with the thinnest step to your right as you face the table. Center the long axis of the phantom to the long axis of the laser light. Center the middle of the crosshair 3/4 of an inch from the right side of the thinnest step. Press “Continue” to start the scan. The step phantom will display in the black box in the left center of the screen. See Exhibit 6-9.



Exhibit 6-9. Step phantom scan

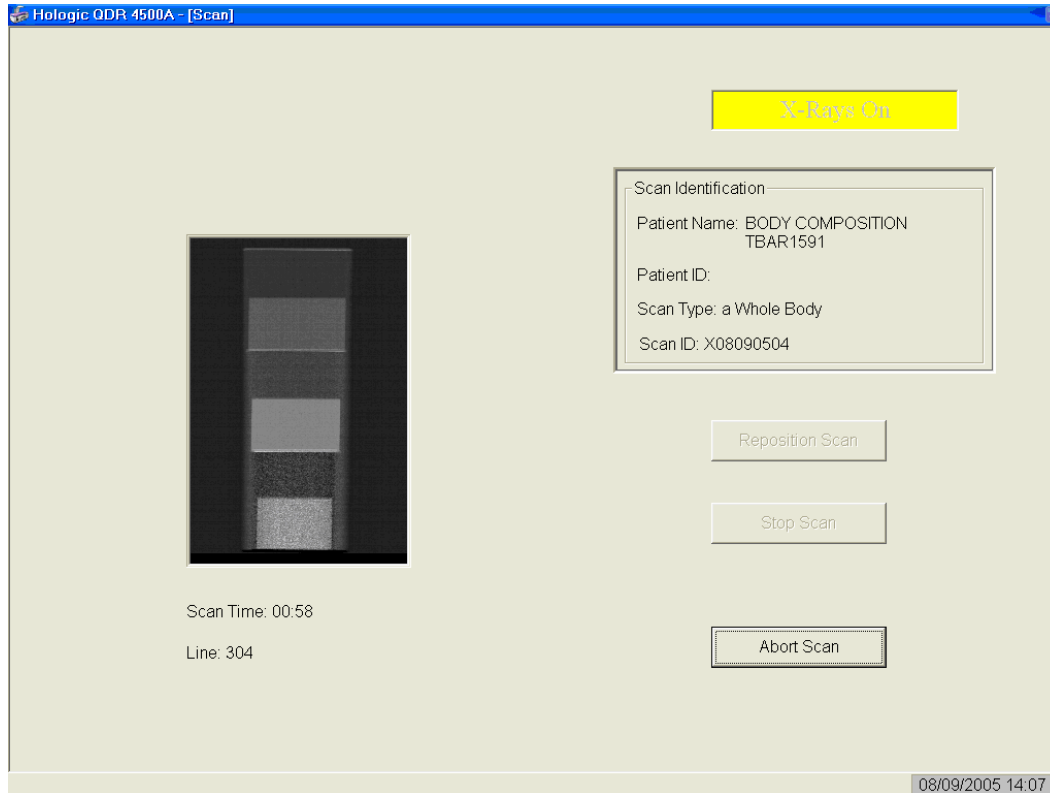

- At the conclusion of the scan, the step phantom is automatically analyzed and the data are stored in a separate file in the system.
- The system will display a message: “The step phantom evaluation was completed successfully.” See Exhibit 6-10.

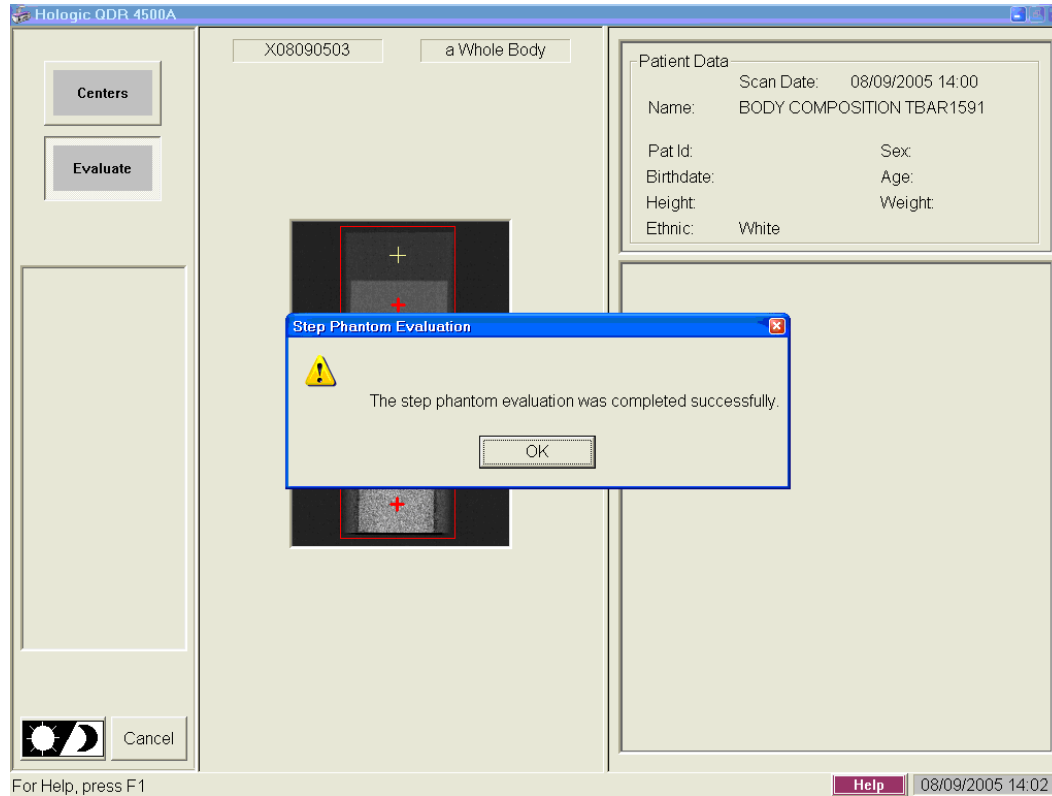
**Exhibit 6-10. Step phantom evaluation completed successfully**

- Press OK.
- The system will display a message: “The step phantom scan for body composition calibration has been completed.” When the table has finished moving, press the “Continue” button to continue. See Exhibit 6-11. (If this window message continues to appear, after pressing continue, press “Abort” to return to the Discovery main menu.)

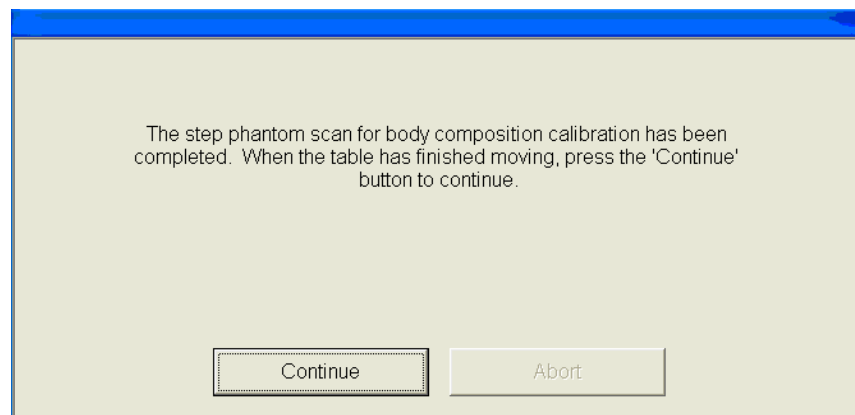
**Exhibit 6-11. Step phantom QC completed, press Continue**

### 6.2.3 Radiographic Uniformity Test

After completion of the step phantom scan, an automatic prompt should come up for the Radiographic Uniformity Test. The system will analyze the scan and give you the standard deviation (SD) values for the High Air and the Low Air. Record these values in ISIS and on the QC scan log sheets. If the prompt does not come up, then follow the instructions below to select the test manually.

Select “Perform Exam” from the Discovery Main Menu. See Exhibit 6-1 (shown earlier). Choose or highlight “Radiographic Uniformity” from the patient list. See Exhibit 6-12. Click OK.

**Exhibit 6-12. Selecting radiographic uniformity from patient list**

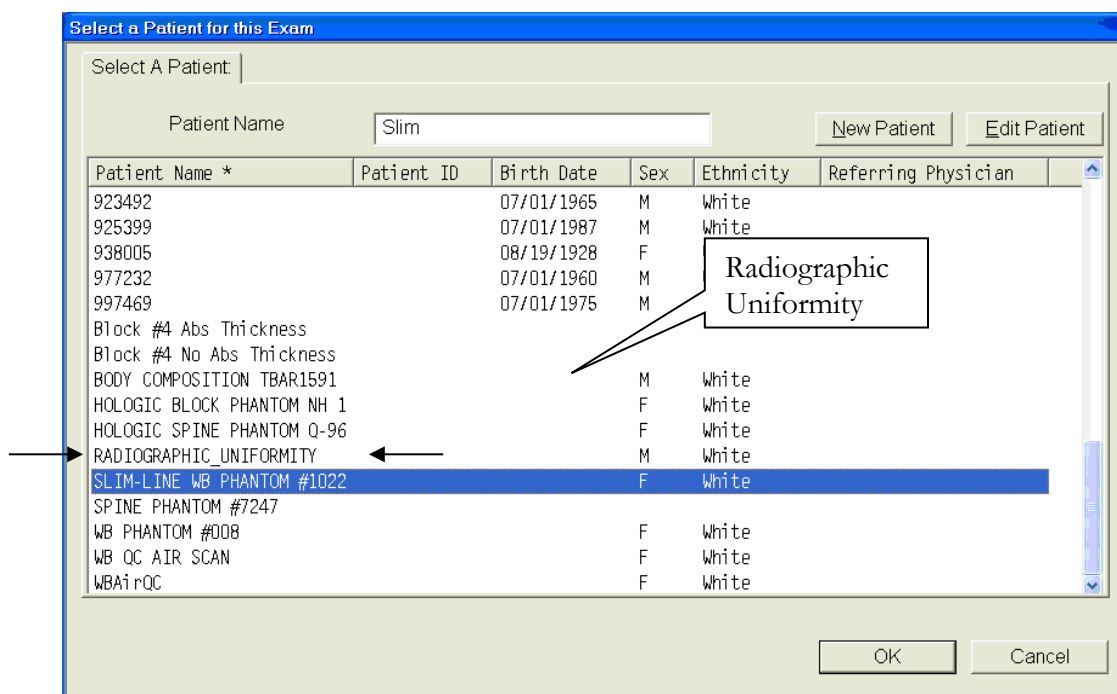

Type in initials in the white text box next to the word Operator (see Exhibit 6-13) and Click OK.

**Exhibit 6-13. Operator box for initials**

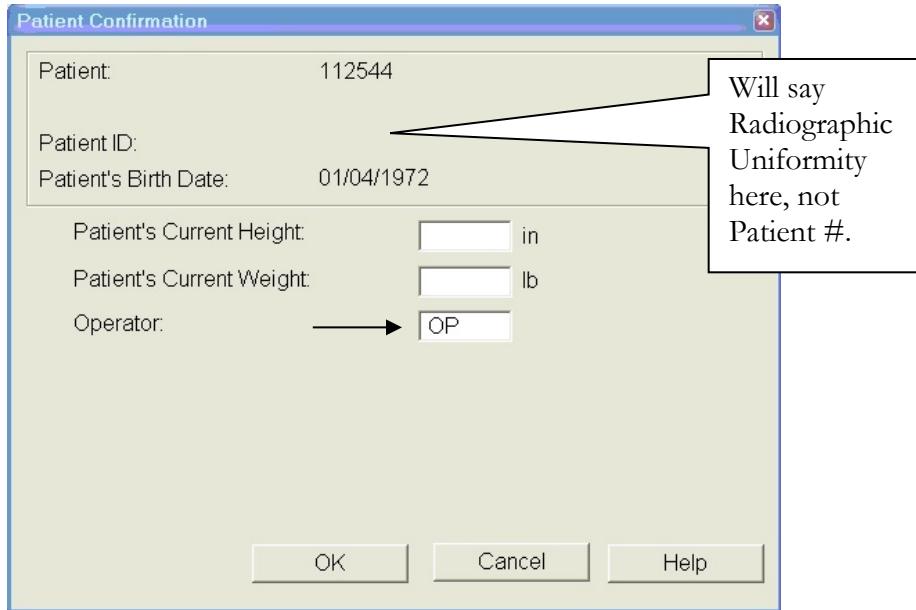

Select "Whole Body" in the Scan Selection screen. See Exhibit 6-14. Click "Next>>."

**Exhibit 6-14. Selecting whole body in the select scan type screen**

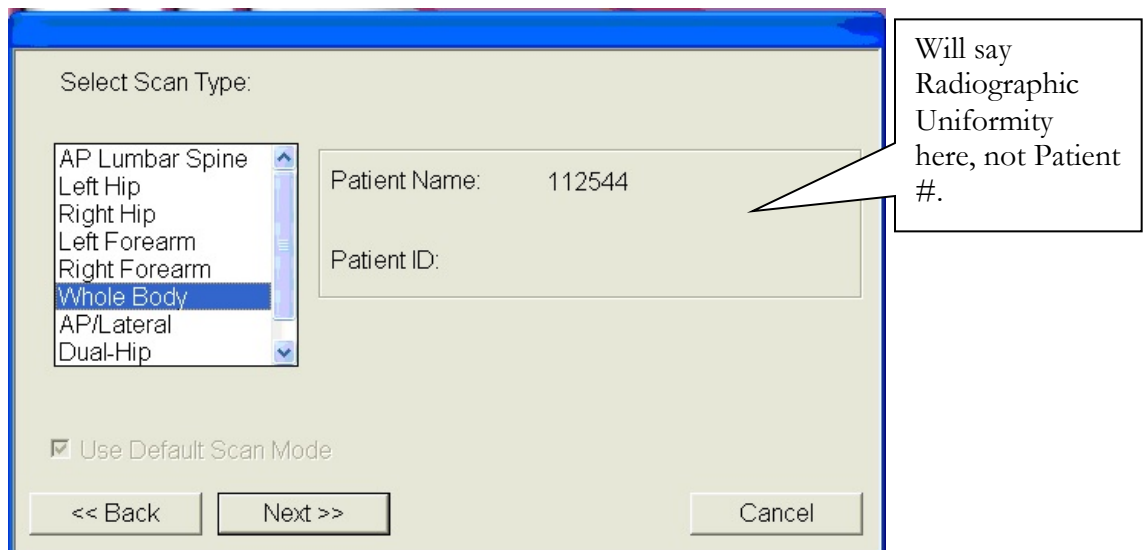

The Scan Parameters screen is displayed. See Exhibit 6-15. Clear entire table of any objects and click “Start Scan.”

**Exhibit 6-15. Radiographic uniformity scan parameters screen**

Will say Radiographic Uniformity here.

**Scan Parameters**

Patient Name: 112544  
Patient ID:  
Scan Type: a Whole Body  
Scan ID: X0809050R

Scan Length: 77.0 in  
Scan Width: 26.4 in  
Line Spacing: 0.5130 in  
Point Resolution: 0.0804 in

4.00 X 0.08 Coll.  
140/100 kVp  
0.8 mA avg.  
165 seconds  
60 Hz

**\*\* XRAY DEVICE READY \*\***  
You may begin scanning

Please position the patient for a Whole Body scan

Start Scan Cancel

The Radiographic Uniformity will display a black box in the left center of the screen. See Exhibit 6-16. A program will automatically analyze the airscan.

#### Exhibit 6-16. Radiographic uniformity test

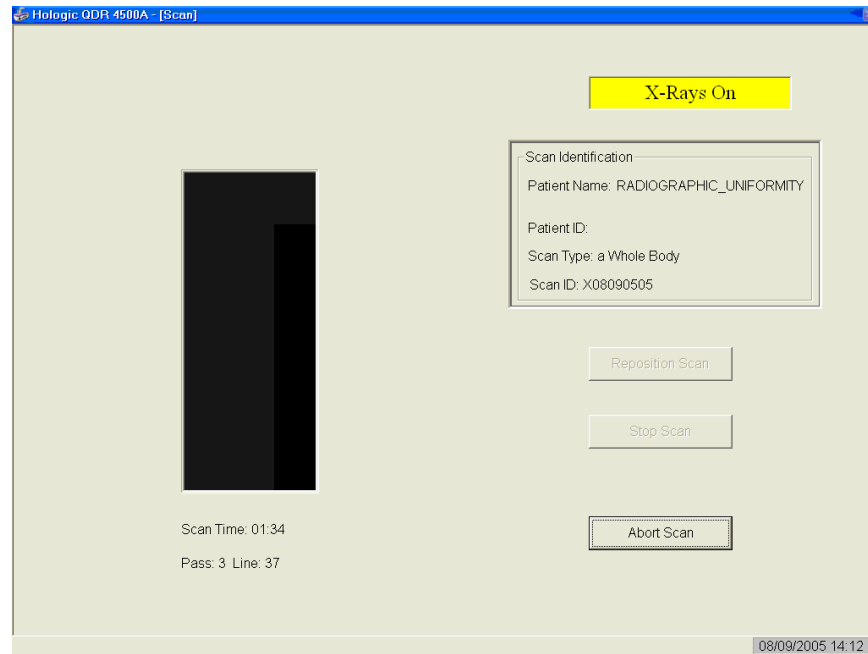

#### 6.2.3.1 Finding the Global Standard Deviation (SD) for the Radiographic Uniformity Test (Airscan)

- In the Discovery main menu, select Utilities, then Service Utilities from the drop-down box, and then “Table Top Radiographic Uniformity” from the second drop-down box.
- Select or highlight the Radiographic Uniformity with the correct scan date (date of QC Test). See Exhibit 6-17.

Exhibit 6-17. Selecting radiographic uniformity for SD results

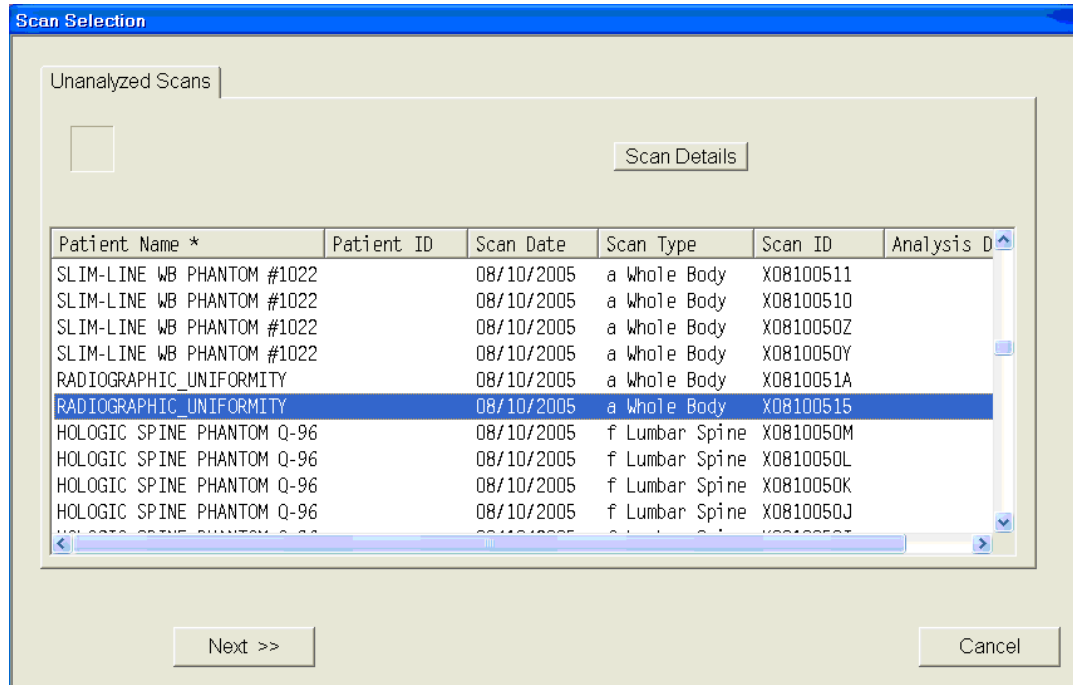

There are two SDs, a High Air and a Low Air. See Exhibits 6-18 and 6-19. Select from the tabs at the top of the window. Enter both numbers in ISIS.

Exhibit 6-18. Low air global stats SD

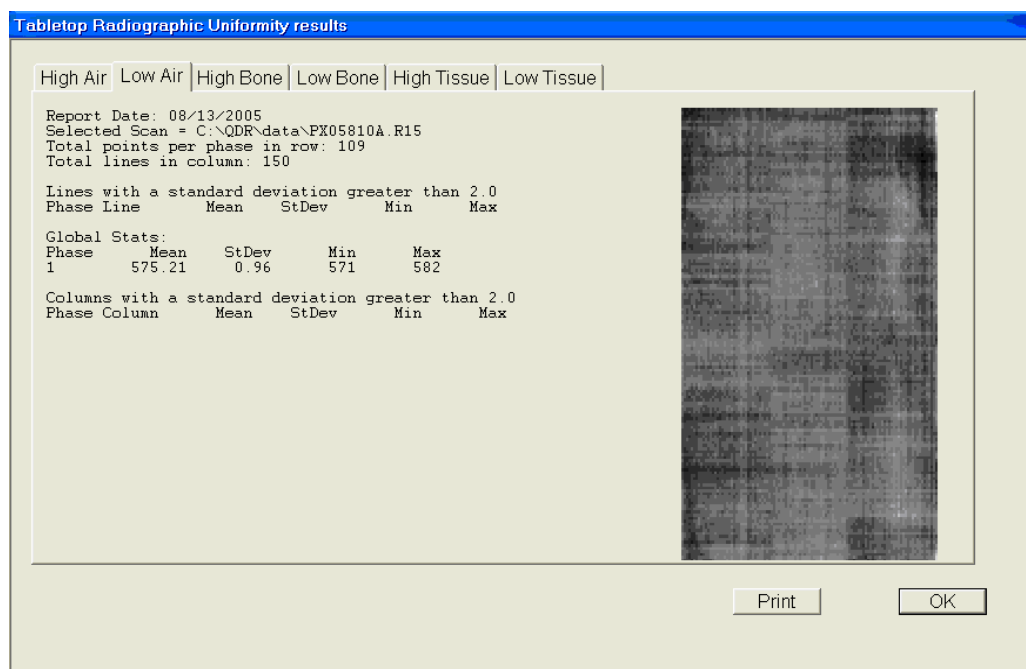

## Exhibit 6-19. High air global stats SD

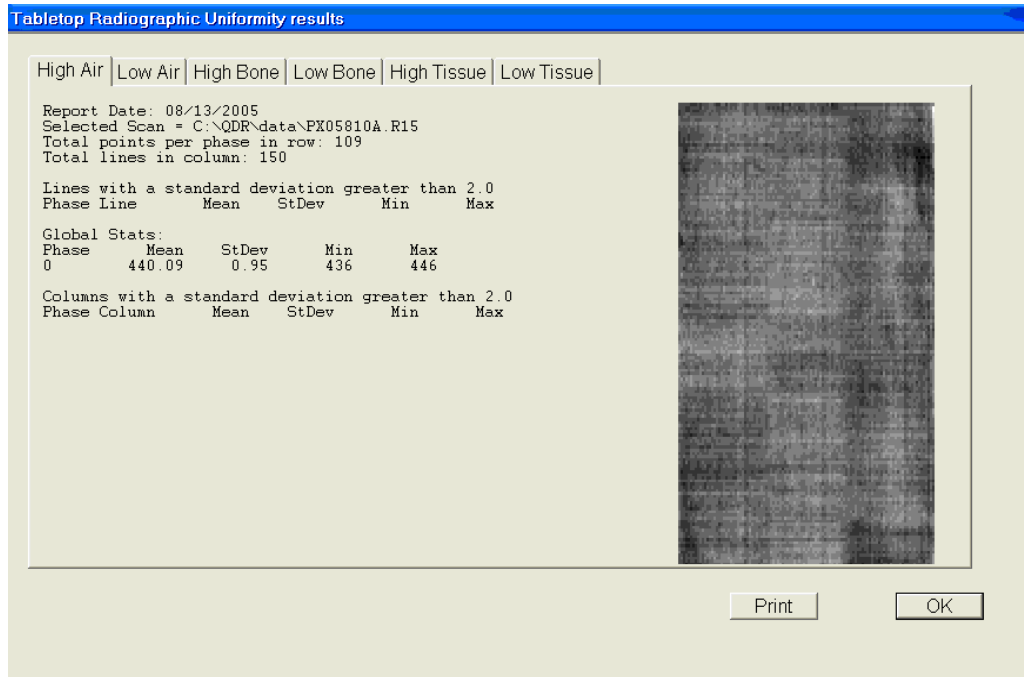

## 6.2.3.2 Procedure If Standard Deviation (SD) Is Greater Than 2.0

Report this to the CLHT AND the MEC manager.

**NOTE:** CLHT and MEC Manager should complete the following:

- Check the results of the Radiographic Uniformity Test and confirm that the scan procedure was completed correctly.
- Perform a second scan and note the results. If the standard deviation is still  $>2.0$ , call the home office to report the results of the test and contact Hologic (see laminated instruction sheets in the DXA room for the names and numbers of the people to contact).
- Record this call on the “Hologic Call Log.” STOP all scans until further notice from Hologic.



### 6.2.4 Slim-Line Whole Body Phantom

Lift the phantom components on and off the table, one at a time. Press the center table button to center the laser. Use the laser to assist in centering the phantom on the table.

Place the bottom layer (base) on the scanner table. (The bottom layer consists of a thin, gray PVC sheet bonded to the largest high density polyethylene [HDPE] piece.) Orient the sheet with the gray PVC on the bottom and the end marked “Head End” at the head end of the table. Place the second large white plastic piece (with beveled edges) on top of the base, using the locating pins as a guide if necessary. The second piece should be placed such that the beveled edge is in contact with the base layer, like a pyramid.

Place the medium-sized white plastic piece on the phantom. Add the second medium-sized white plastic piece (with the beveled edges), again forming a pyramid.

Place the smallest white plastic piece on the phantom.

Add on the smallest white plastic piece (with the beveled edges) to complete the pyramid.

Secure the stack with the two locating pins. The final assembly will form a pyramid. (See Figure 6-3.) It is important that the phantom is placed in exactly the same configuration every time it is scanned.

**Figure 6-3.** Slim-Line whole body phantom fully assembled

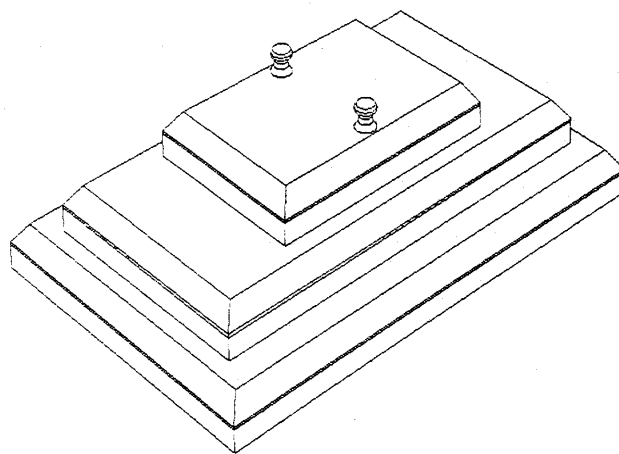

### 6.2.4.1 Phantom Positioning

The phantom should be centered top to bottom and side to side on the table. Use the laser to assist in centering the phantom.

### 6.2.4.2 Scanning the Slim-Line Whole Body Phantom (Days 1, 3, 5)

- Confirm that the phantom is centered, parallel with the long axis of the table, and is correctly oriented with respect to the head of the table.
- Confirm all artifacts are removed from the scanner table surface.
- Select “Perform Exam” from the Discovery Main Menu. See Figure 6-1 shown earlier.
- Choose Slim-Line WB Phantom #XXXX (XXXX is 1013 on MEC 1, 1021 on MEC 2, or 1022 on MEC 3) from the list or begin typing “Slim” in the white text box next to Patient Name, and the name will highlight in the list. See Exhibit 6-20. Click OK.

**Exhibit 6-20. Selecting slim-line WB phantom scan**

Select a Patient for this Exam

Select A Patient

Patient Name

Patient Name *	Patient ID	Birth Date	Sex	Ethnicity	Referring Physician
923492		07/01/1965	M	White	
925399		07/01/1987	M	White	
938005		08/19/1928	F	White	
977232		07/01/1960	M	White	
997469		07/01/1975	M	White	
Block #4 Abs Thickness					
Block #4 No Abs Thickness					
BODY COMPOSITION TBAR1591			M	White	
HOLOGIC BLOCK PHANTOM NH 1			F	White	
HOLOGIC SPINE PHANTOM Q-96			F	White	
RADIOGRAPHIC UNIFORMITY			M	White	
<b>SLIM-LINE WB PHANTOM #1022</b>			F	White	
SPINE PHANTOM #7247					
WB PHANTOM #008			F	White	
WB QC AIR SCAN			F	White	
WBAi rQC			F	White	

Type initials in the white text box next to the word Operator (see Exhibit 6-21) and click OK.

**Exhibit 6-21. Operator box for initials**

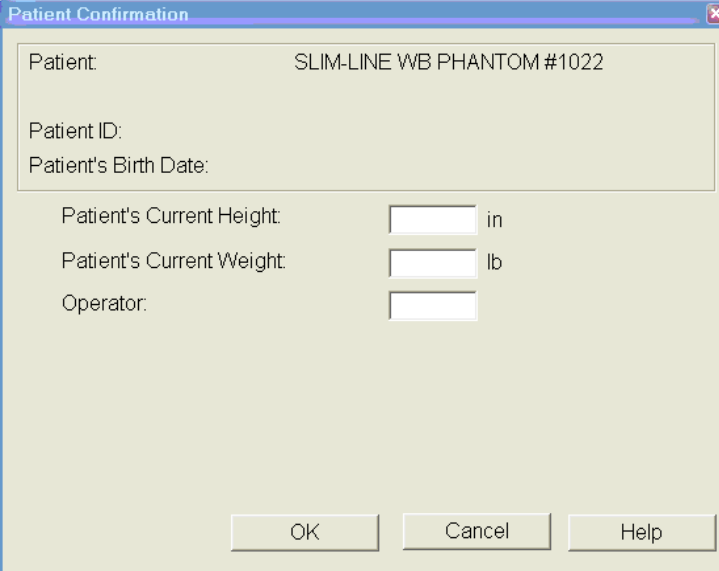

The "Patient Confirmation" dialog box displays the following information and input fields:

- Patient: SLIM-LINE WB PHANTOM #1022
- Patient ID:
- Patient's Birth Date:
- Patient's Current Height: [ ] in
- Patient's Current Weight: [ ] lb
- Operator: [ ]

Buttons at the bottom: OK, Cancel, Help

CONFIRM that "Slim-Line WB Phantom #XXXX" is in the Patient Field. Select "Whole Body" in the Scan Selection screen. See Exhibit 6-22. Click "Next>>."

**Exhibit 6-22. Selecting whole body in the select scan type screen**

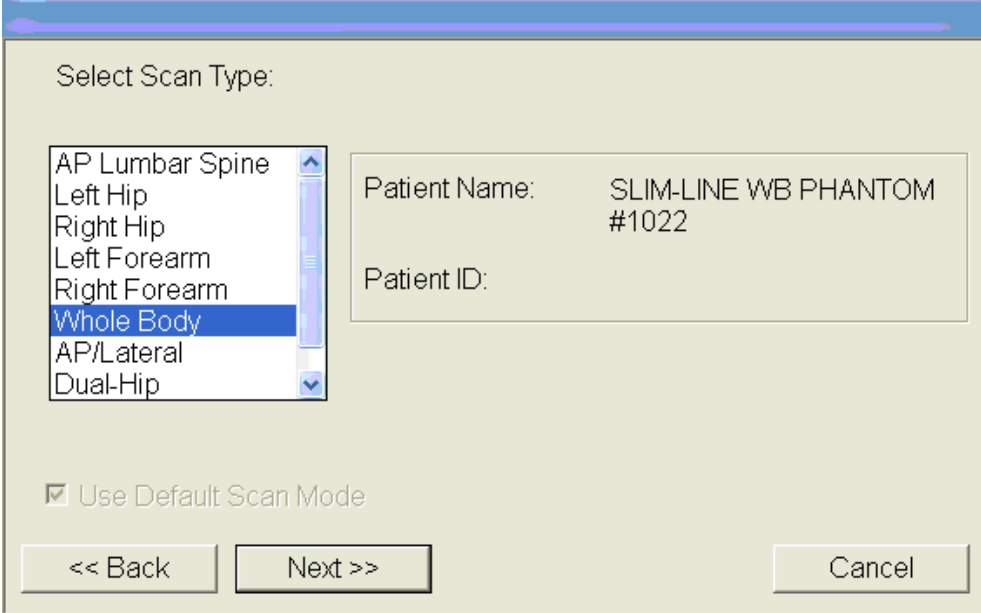

The "Select Scan Type" dialog box displays the following information and controls:

- Select Scan Type:
- AP Lumbar Spine
- Left Hip
- Right Hip
- Left Forearm
- Right Forearm
- Whole Body (highlighted)
- AP/Lateral
- Dual-Hip
- Patient Name: SLIM-LINE WB PHANTOM #1022
- Patient ID:
- Use Default Scan Mode
- << Back
- Next >>
- Cancel

The Scan Parameters screen is displayed. Click “Start Scan.” See Exhibit 6-23.

**Exhibit 6-23. Slim-line scan parameters screen**



The machine will scan the phantom. As the scan is completing, carefully inspect the image to ensure that the phantom was centered, parallel with the long axis of the scanner table, and the phantom’s head appears at the top of the image.

If the scan is not satisfactory, reposition the phantom again, carefully following the instructions above.

### 6.2.4.3 Scanning the Slim-Line Whole Body Phantom for Start of Stand

Confirm that the phantom is centered, parallel with the long axis of the table, and is correctly oriented with respect to the head of the table. Confirm all artifacts are removed from the scanner table surface. Follow procedures from Section 6.2.4.2 for scanning the first Slim-Line Whole Body Phantom scan.

If the scan is satisfactory, slide the phantom down the table and then recenter. Scan four more times with repositioning between each scan, checking that each scan is satisfactory.

**NOTE:** Autoscan cannot be used for any of the scans.

### 6.2.5 Hologic Femur/Hip Phantom (Weekly Scan)

- Center the table. When the table motion is complete, position the Hologic Femur/Hip Phantom on the table and align laser cross with mark on phantom;
- Select “Perform Exam” from the Discovery Main Menu. See Exhibit 6-1 shown earlier; and
- Choose/highlight “Hologic Femur/Hip Phantom #WHF-XXXX” (XXXX is 0018 on MEC 1, 0021 on MEC 2, or 0013 on MEC 3) from the list. See Exhibit 6-24. Click “OK.”

**Exhibit 6-24. Selecting Hologic Femur/Hip Phantom from patient menu**

Select a Patient for this Exam

Select A Patient: |

Patient Name

Patient Name *	Patient ID	Birth Date	Sex	Ethnicity	Referring Physician
996752		02/28/1995	F	White	
997469		07/01/1975	M	White	
999179		07/27/1975	M	White	
999854		09/18/1994	M	White	
Block #4 Abs Thickness					
Block #4 No Abs Thickness					
BODY COMPOSITION TBAR1591			M	White	
HOLOGIC BLOCK PHANTOM NH 1			F	White	
Hologic Hip Phantom #WHF-0021			F	White	
HOLOGIC SPINE PHANTOM Q-96			F	White	
RADIOGRAPHIC_UNIFORMITY			M	White	
SLIM-LINE WB PHANTOM #1022			F	White	
SPINE PHANTOM #7247					
WB PHANTOM #008			F	White	
WB QC AIR SCAN			F	White	

Type initials in the white text box next to the word Operator (Exhibit 6-25) and click “OK.”

**Exhibit 6-25. Operator box for initials**

- CONFIRM that “Hologic Femur/Hip Phantom #WHF- XXXX” is in the Patient Field.
- Select “**Right Hip**” in the Scan Selection screen (Exhibit 6-26) . **Uncheck** the “Use Default Scan Mode” and Click “Next>>”.

**Exhibit 6-26. Selecting Right Hip in the scan selection screen**

In the Select Right Hip Scan Mode window select “Fast Array (f)”. See Exhibit 6-27.

**Exhibit 6-27. Right Hip Scan Mode options**

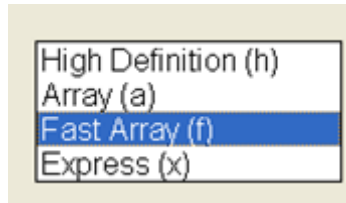

The Scan Parameters screen is displayed (Exhibit 6-28).

**Exhibit 6-28. Hologic Femur/Hip Phantom Scan Parameters screen**

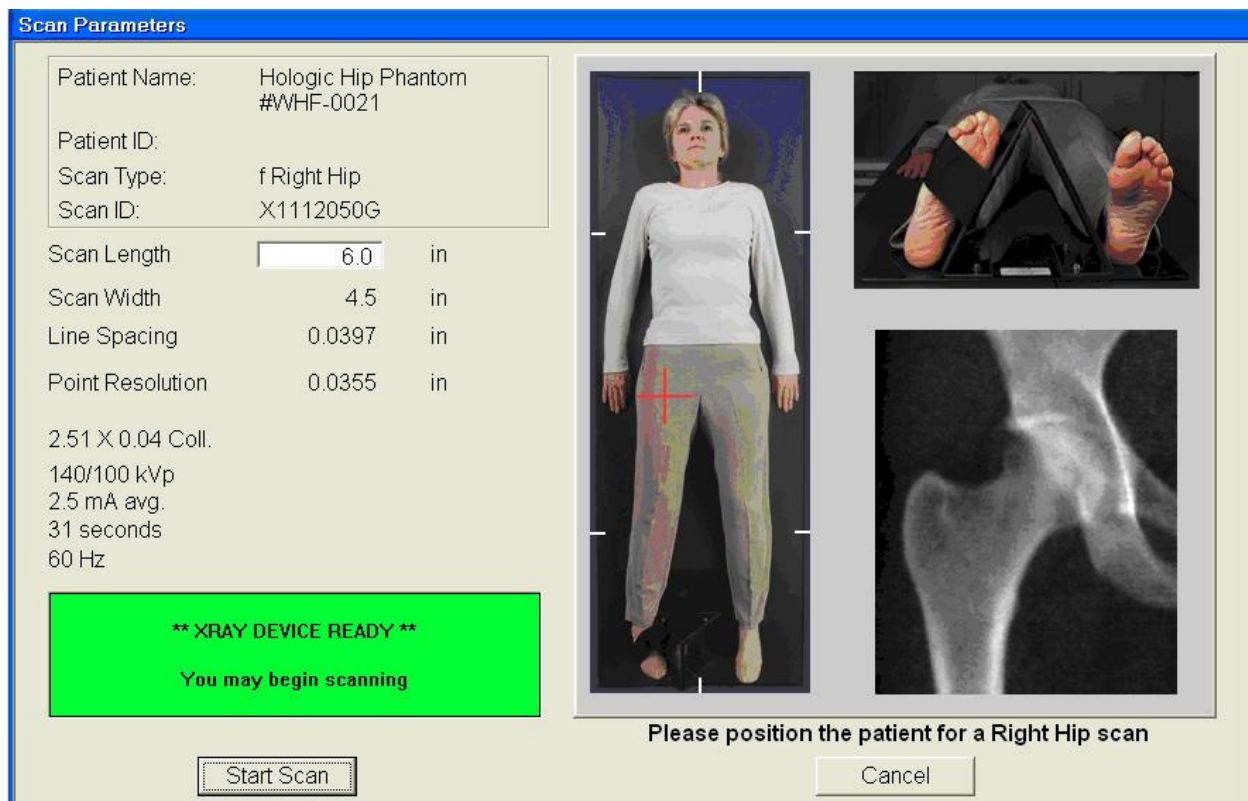

**Scan Parameters**

Patient Name: Hologic Hip Phantom  
#WHF-0021

Patient ID:

Scan Type: f Right Hip

Scan ID: X1112050G

Scan Length  in

Scan Width 4.5 in

Line Spacing 0.0397 in

Point Resolution 0.0355 in

2.51 X 0.04 Coll.

140/100 kVp

2.5 mA avg.

31 seconds

60 Hz

**\*\* XRAY DEVICE READY \*\***

**You may begin scanning**

Please position the patient for a Right Hip scan

If phantom is positioned correctly, click “Start Scan,” and the machine will scan the phantom (Exhibit 6-29).

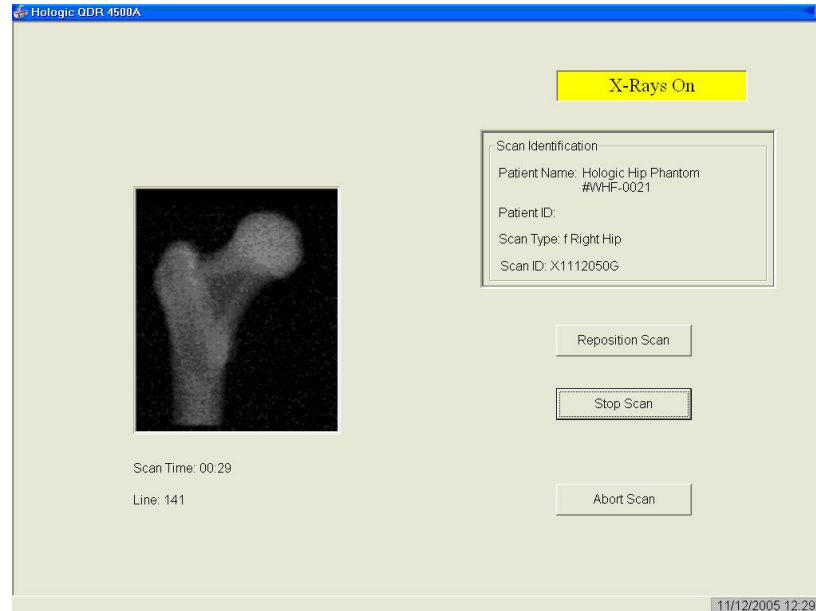
**Exhibit 6-29. Machine scanning Femur/Hip phantom**

As the scan is completing, carefully inspect the image to ensure that the phantom was correctly positioned. If the scan is not satisfactory, click “Reposition Scan,” use the scrollbars or mouse to position the phantom correctly in the black box, and click “Restart Scan.”

Upon successful completion of the scan, select “Exit Exam” to return to the Discovery Main menu, or to perform a different scan. Select “New Scan” if performing another Femur/Hip Phantom scan. See Exhibit 6-30.

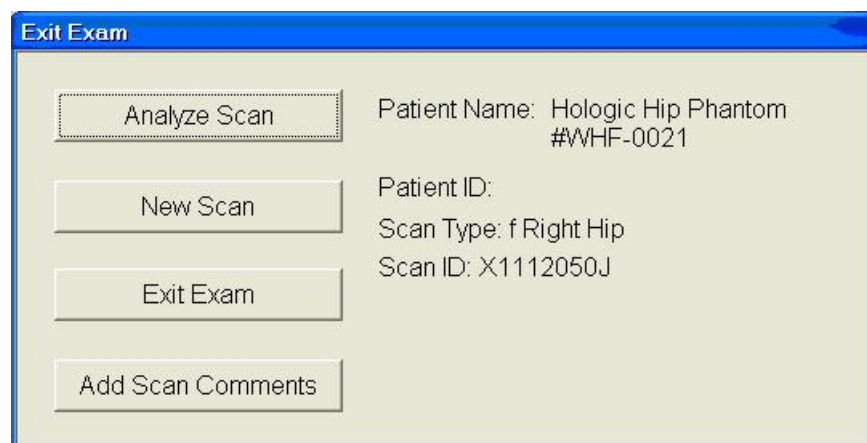
**Exhibit 6-30. Exit exam/new scan window box**



## 6.2.6 Circulating HASP (HSP Q-96)

**NOTE:** This phantom is a different phantom from the one used for daily scans. Do not use the regular spine phantom that is used for daily QC scans.

Center the table. When the table motion is complete, position the Hologic Circulating Spine Phantom on the table at the position indicated by the laser cross. The positioning star should be pointing to the foot of the table (your left as you face the table). The laser cross should be centered on the positioning star. The laser line should be centered on the line between the numbers 9 and 6.

On the Discovery main menu screen, click “Perform Exam.” Choose Phantom Q-96 from the list or begin typing “Phantom Q-96” in the white text box next to Patient Name, and the name will highlight in the list. Click OK. Type in initials in the white text box next to the word Operator. Click OK. CONFIRM that “MEC X Circulating Spine Phantom Q-96” is in the Patient field. Select “AP Lumbar Spine” in the Scan Selection screen. Uncheck the “Use Default Scan Mode” and Click “Next>>.” In the Select Scan Mode window, select “Fast Array (f)” and click “Next >>.”

The Scan Parameters screen is displayed. Click “Start Scan.” The machine will scan the phantom. Repeat these steps for the remaining scans.

## 6.2.7 Circulating Block Phantom (Hologic Block Phantom NH #1)

Center the table. When the table motion is complete, position the Hologic circulating block phantom on the table at the position indicated by the laser cross. The positioning star should be pointing to the foot of the table. The laser cross should be centered on the positioning star. The laser line should be positioned between the numbers 1 and 2.

On the Discovery main menu screen, click “Perform Exam.” Choose MEC X Phantom Block NH #1 from the list or begin typing “Phantom Block...” in the white text box next to Patient Name and the name will highlight in the list. Click OK. Type in initials in the white text box next to the word Operator. Click OK. CONFIRM that “MEC X Phantom Block NH #1” is in the Patient field. Select “AP Lumbar Spine” in the Scan Selection screen. Uncheck the “Use Default Scan Mode” and Click “Next>>.” In the Select Scan Mode window, select “Fast Array (f)” and click “Next >>.”

The Scan Parameters screen is displayed. Click “Start Scan.” The machine will scan the phantom. Repeat these steps for the remaining scans.

## 6.2.8 Hologic Whole Body Phantom #008

### 6.2.8.1 Phantom Assembly

Lift the phantom components on and off the table one at a time. Refer to the diagram to assist in positioning the phantom correctly.

Place the bottom layer (base) of the phantom on the scanner table. (The bottom layer consists of a thin gray PVC sheet attached to a large white plastic sheet that contains two plastic locating pins.) Orient the serial numbers to the head end of the table. Position the bottom layer such that the gray PVC is on the bottom (the gray PVC is in contact with the table and the two alignment holes are facing out of the plane of the table toward the ceiling).

Place the second large white plastic piece on top of the phantom base, using the alignment holes as a guide. This piece should be placed such that the beveled edge forms a 45° angle with the base, with the serial numbers oriented to the head of the table. Next, place the medium size white plastic pieces on the phantom, with the top medium piece forming a 45° angle with the bottom medium piece. Make sure the serial numbers are toward the head of the table.

Place the small white plastic pieces on top to resemble the medium and large setup. Insert the locating pins through the alignment holes. The final assembly will form a pyramid (refer to the diagram, side view). Check that the phantom configuration is positioned exactly as outlined.

### 6.2.8.2 Phantom Positioning

Position the phantom in the center of the scanner table. Put the head of the phantom at the head of the table. Place the phantom’s head 24 inches from the table head. (The head of the phantom is the end that has the phantom serial number label attached to it.) Carefully position the phantom parallel with the long axis of the table, using the table pad markings as a guide.

### 6.2.8.3 Scanning the Whole Body Phantom

Confirm that the phantom is centered, is parallel with the long axis of the table, and is correctly oriented with respect to the head of the table. Confirm that all artifacts are removed from the scanner table surface.

On the Discovery main menu screen, click “Perform Exam” at the bottom of the screen. Choose WB Phantom #008 (008 is the serial number of the Whole Body Phantom) from the list or begin typing WB... in the white text box next to Patient Name and the name will highlight in the list. Click OK. Type in initials in the white text box next to the word Operator. Click OK. CONFIRM that “WB Phantom #008” is in the Patient field. Select “Whole Body” in the Select Scan Type box. Click “Next >>.”

The Scan Parameters screen is displayed. Click “Start Scan.” The machine will scan the phantom (Figures 6-4 and 6-5).

**Figure 6-4.** Layout of whole body phantom—top view

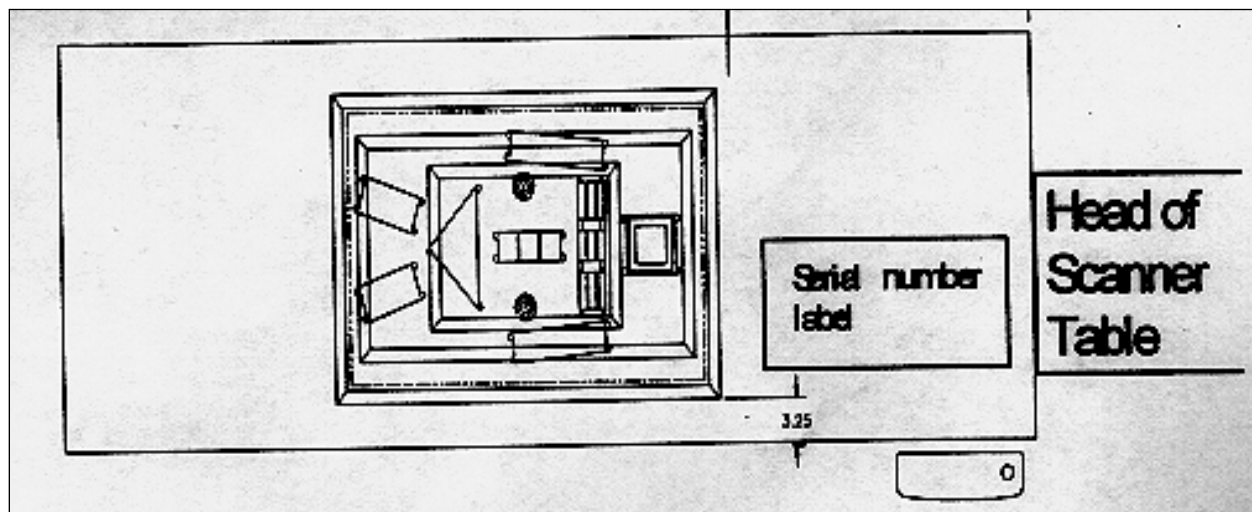

**Figure 6-5.** Layout of whole body phantom—side view

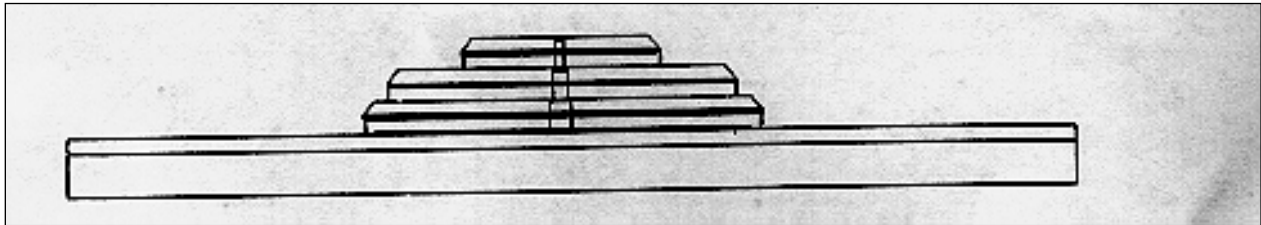

Carefully inspect the scan image to ensure that the phantom was centered and parallel with the long axis of the scanner table, and that the phantom's head appears at the top of the image. If the scan image was not satisfactory, click "Abort" and reposition the phantom again, carefully following the instructions above. A total of five scans should be completed.

## 6.3 QC Scan Checklists

The QC Scan checklists were developed to ensure that all QC Scans are completed as outlined in the protocol. There are two forms: one is used for all daily, three times/week, and weekly QC scans; the other is used for all Start of Stand QC scans. See Appendixes F and G for sample forms.

### 6.3.1 Instructions for Completing Weekly QC Scan Checklist

The checklist should be filled out on each day of the workweek by the health technologist who is responsible for completing the QC scans that week. As scans are completed each day, check the appropriate boxes.

During the week, keep the checklist in the Body Composition Procedures manual. At the end of each week, file the completed form in the Weekly QC Scans Checklist section in the back of the manual, behind the previous week's form.

### 6.3.2 Instructions for Completing Start of Stand QC Scan Checklist

The checklist should be filled out at the start of the stand by the health technologist who is responsible for completing the start of stand scans. As each scan is completed, check the appropriate box.

File the completed form in the Start of Stand QC Scans Checklist section in the back of the manual, behind the form from the previous stand.

### 6.3.3 Instructions for Accessing Blank QC Checklist Forms

Blank QC Checklists for all DXA scans are stored electronically in the “Blank Forms” folder on the ISIS computer in the MEC. Use the following steps to access the forms.

- Open Microsoft Word. (Click on the icon on the desktop.)
- From the File menu, select Open.
- Select the “MECStaff” directory.
- Select “Blank Forms.”
- Select the appropriate form:
  - DX\_QC-Weekly Scan Checklist; or
  - DX\_QC-Start of Stand Scan Checklist
- Open the document by double-clicking on it or by selecting it and clicking Open.
- From the File menu, select Print.

## 6.4 Data Entry Screens for QC on Equipment

When you log onto the application before the quality control checks are performed, the system displays a message: “One or more of your QC checks have not been performed.” See Exhibit 6-31. Click OK to this message.

**Exhibit 6-31.** Quality control reminder message box

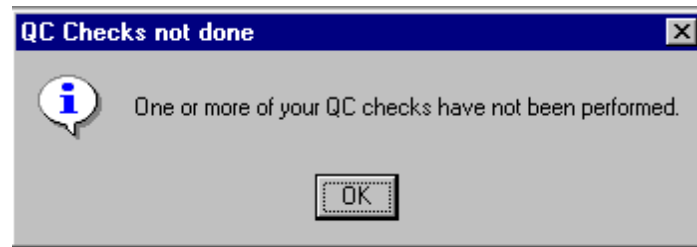

When you want to complete the QC checks, select Utilities. Then select Quality Control from the menu. See Exhibit 6-32.

**Exhibit 6-32.** Utilities menu to select quality control

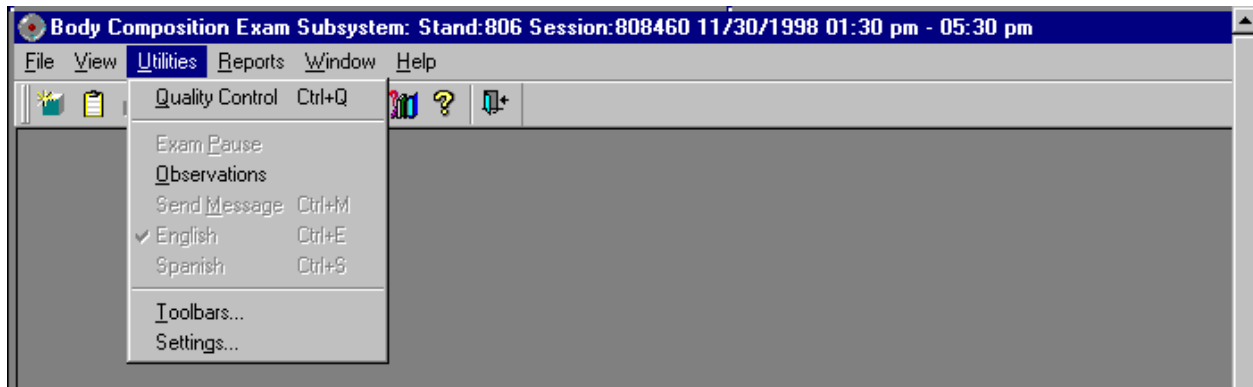

- Clicking on the QC icon from the Toolbar can also access the QC screens.
- When QC is selected from the Utilities menu, the User ID entry box will be displayed. See Exhibit 6-33.

Exhibit 6-33. Quality control logon

Body Composition Exam ...

Please enter in your user id

OK Cancel

Each technologist will have a personal ID. This ID will be used to identify the person who completed the QC checks for this time period. Enter your User ID and click OK.

If you do not want to do the QC checks at this time, click Cancel.

### 6.4.1 QC Daily Checks

The Daily QC check data entry screen is shown in Exhibit 6-34

Exhibit 6-34. Quality control daily checks

Body Composition Quality Control Checks

Start of Stand Daily Weekly End of Stand

QC Check	Done	Result	Comment
DXA - check table scan area is clear of articles that might interfere with table movement.	<input type="checkbox"/>		
DXA - check runner area of table is clear of articles that might interfere with table movement.	<input type="checkbox"/>		
DXA - complete spine phantom check.	<input type="checkbox"/>		
DXA-complete 1 slim-line WB phantom scan on Days 1, 3, and 5. (Result='Done' on days 1,3,5; N/A on other days.)	<input type="checkbox"/>		

OK Cancel

On the QC screens, check “Done” for the listed items when that item has been completed. You are not required to enter anything in the “Result” or “Comment” fields unless there is a problem.

The “Result” field is used to enter values for selected QC items if required. The Comments field is used to enter information about problems encountered with the QC item check. Use the scroll bar

to move to the remaining items. When you are finished with the daily item checks, click OK to close the QC box.

## 6.4.2 QC Weekly Checks

The Weekly QC check data entry screen is shown in Exhibit 6-35.

**Exhibit 6-35. Quality control weekly checks**

QC Check	Done	Result	Comment
1 Step Phantom	<input type="checkbox"/>		
1 Radiographic Uniformity scan	<input type="checkbox"/>		
Complete all daily checks.	<input type="checkbox"/>		
Complete 1 Femur/Hip Scan	<input type="checkbox"/>		

Complete all the daily checks. Check “Done” for each item on the weekly checks when complete. Use the Scroll down bar on the right of the screen to get to the remaining items.

If you notice a problem with any of the items on the checklist, make a note of this in the comment box and report it to the chief tech AND the MEC manager.



### 6.4.3 QC Start of Stand Checks

The QC Start of Stand check data entry screens are shown in Exhibits 6-36 and 6-37.

Exhibit 6-36. Quality control start of stand checks (1)

QC Check	Done	Result	Comment
Archive Hologic data on to CD.	<input type="checkbox"/>		
Complete all daily checks.	<input type="checkbox"/>		
Complete all weekly checks.	<input type="checkbox"/>		
DXA - Check that locking pins have been removed before attempting to complete any scans.	<input type="checkbox"/>		

Exhibit 6-37. Quality control start of stand checks (2)

QC Check	Done	Result	Comment
1 Radiographic Uniformity scan	<input checked="" type="checkbox"/>		
1 Step phantom - this is a whole body phantom	<input checked="" type="checkbox"/>		
5 Slim Line Whole Body Phantom scans	<input checked="" type="checkbox"/>		
5 Femur/Hip Phantom scans	<input checked="" type="checkbox"/>		

Complete all Start of Stand checks. Start of Stand checks include all daily and weekly checks. When the Start of Stand checks are complete, click OK to close the QC checks.

#### 6.4.4 QC Yearly Checks

The Yearly QC data entry screen is shown in Exhibit 6-38. Complete all the yearly checks at the beginning of the year for each MEC. When the yearly checks are complete, click OK.

Complete the remaining Start of Stand checks. When you have completed all checks, click OK to close the QC box.

**Exhibit 6-38. Quality control yearly checks**

QC Check	Done	Result	Comment
5 Circulating Hologic Whole Body Phantom scans	<input type="checkbox"/>		
10 Circulating Spine Phantom scans (Q96)	<input type="checkbox"/>		
10 Circulating Block Phantom scans	<input type="checkbox"/>		

### 6.4.5 QC End of Stand Checks

Clean the DXA table by wiping it down with a clean damp cloth and liquid Ivory soap. Do not complete this item until all exams for the stand have been completed to ensure that no scans are done on a damp table. See Exhibit 6-39.

Exhibit 6-39. Quality control end of stand checks

QC Check	Done	Result	Comment
Clean DXA table - wipe down with damp clean cloth and liquid Ivory Soap after all exams for the stand have been completed.	<input type="checkbox"/>		

If the table needs to be cleaned more often, follow the procedures for end of stand cleaning at the end of the examination week. This will allow the table to dry prior to the beginning of the next week.

### 6.4.6 Incomplete QC Checks

If you do not check that all items are complete, the system will display this message: “Not all of the QC items were done. Do you wish to exit?” See Exhibit 6-40.

Exhibit 6-40. Quality control incomplete entry

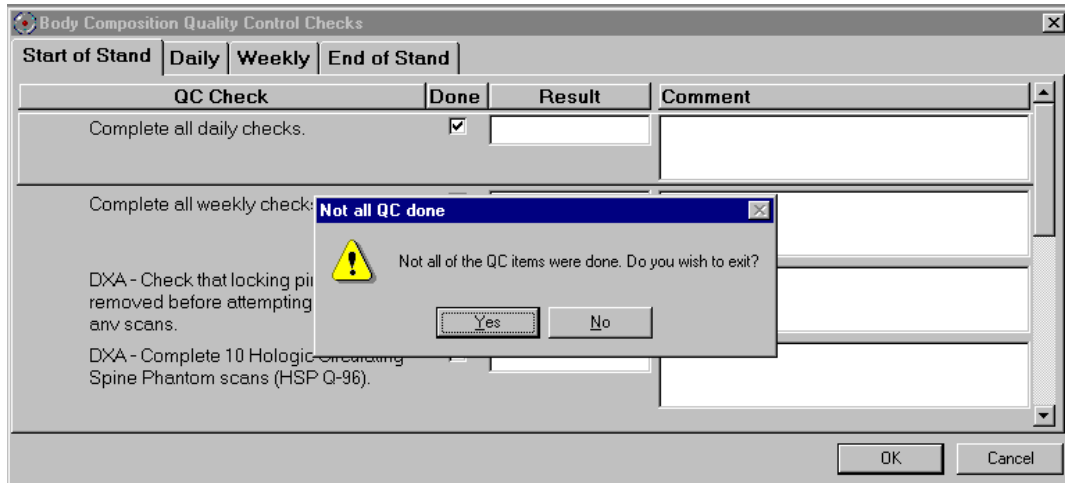

If you want to complete the items before exiting, click “No” to this message and complete the items. If you wish to exit without completing all the QC checks, click “Yes” to this message.

If all QC items were not complete, the system will remind you each time you log on that the QC checks are not complete.

# **Appendix A**

## **DXA Scripts**



# Appendix A

## DXA Scripts

### **Suggested Introduction to Component (English Version)**

In this room, we are going to be doing one or more scans of your body that will tell us how strong your bones are or how much body fat you have. I will explain in more detail as I do the exams. At this time, please remove all objects from your pockets and place them in this container. Please have a seat up here on the table and get as comfortable as possible. I am going to ask you a few questions before I start the exam.

### **Suggested Explanation of Whole Body DXA Scan (English Version)**

For this examination, I will be doing a scan of your body with this machine. It will tell us how much body fat you have. Now please lie down on the table and I will position you for the scan. I'm going to pull up on your shoulders to straighten you. I will position your arms and feet correctly for the scan and then wrap these Velcro straps loosely around your ankles to hold them in place. The scan will take about 3 minutes to complete and you will not feel anything except for the table movement. As the machine scans your body, the table will move up and down and back and forth. This overhead arm (the C-arm) will also be moving. In order to receive a good quality scan, it is important that you lie perfectly still during the scan and do not talk.

### **Suggested Explanation of Femur Scan (English Version)**

This scan will be of your hip, it will tell us how strong your bones are. For this scan, please continue to lie still with your legs flat against the table. I will rotate your left leg inward slightly and then keep it in place using this foot brace. Please place your arms across your chest. You will not feel anything during the scan. Please be as still as possible and do not talk during the scan.

### **Suggested Explanation of AP Lumbar Spine (English Version)**

These spine scans will also tell us how strong your bones are. For this spine scan, you will lie flat on the table. I'm going to place a pillow under your head. Then I am going to bend your legs at a 90-degree angle at the hip and knee by placing them on this large, soft, cube-shaped pillow. You will not feel anything during this scan. Please be as still as possible and do not talk during the scan.

### **Suggested Explanation after Completion of Scans (English Version)**

Please stay lying down until I have moved the overhead arm out of the way. Now you can sit up. You will receive the results in the mail in 12-14 weeks. Let's find out where you go next.

### **Suggested Introduction to Component (Spanish Version)**

“En esta habitación, le haremos uno o más exámenes del cuerpo que nos dirán qué tan fuertes están sus huesos o cuánta grasa corporal tiene usted. Se lo explicaré con más detalle mientras hago los exámenes. Ahora por favor saque todo lo que tiene en los bolsillos y póngalo aquí, en este recipiente. Por favor siéntese aquí, sobre la mesa y póngase lo más cómodo(a) posible. Le voy a hacer algunas preguntas antes de hacerle el examen.

### **Suggested Explanation of Whole Body DXA Scan (Spanish Version)**

Para este examen, le voy a hacer un escáner del cuerpo con esta máquina. Nos dirá cuánta grasa corporal tiene usted. Por favor acuéstese sobre la mesa y lo(a) voy a poner en la posición correcta para el examen. Le voy a subir ligeramente de los hombros para enderezarle. Le voy a poner los brazos y los pies en la posición correcta y después le pondré esta cinta Velcro, no muy apretada, alrededor de los pies para sostenerlos en su lugar. El escáner durará unos 3 minutos y usted no sentirá nada excepto el movimiento de la mesa. Mientras el escáner pasa por su cuerpo, la mesa subirá, bajará y se moverá hacia adelante y atrás. Este brazo proyector también se estará moviendo. Para poder recibir una imagen de buena calidad, es importante que no se mueva. Por favor no hable durante el escáner.

### **Suggested Explanation of Femur Scan (Spanish Version)**

Este escáner será para su cadera, y nos dirá qué tan fuertes están sus huesos. Para este escáner, por favor continúe acostado/a sin moverse con las piernas extendidas sobre la mesa. Voy a moverle la pierna izquierda un poco hacia adentro y después la mantendré en esa posición usando estas bandas para los pies. Por favor cruce los brazos sobre el pecho. Usted no sentirá nada durante este escáner. Por favor quédese lo más quieto(a) posible y no hable durante el escáner.

### **Suggested Explanation of AP Lumbar Spine, IVA AP Spine, and IVA Lateral Spine Scans (Spanish Version)**

Estos escáneres de la columna vertebral también nos dirán qué tan fuertes están sus huesos. Para estos escáneres de la columna vertebral, usted tendrá que acostarse extendido sobre la mesa. Le voy a poner una almohada debajo de la cabeza. Después, le voy a doblar las piernas en un ángulo de 90 grados en la cadera y las rodillas poniéndolas en esta almohada grande y suave en forma de cubo. Usted no sentirá nada durante este escáner. Por favor quédese lo más quieto(a) posible y no hable durante el escáner.

### **Suggested Explanation after Completion of Scans (Spanish Version)**

Por favor quédese acostado(a) hasta que yo retire el brazo proyector. Ya se puede sentar. Recibirá los resultados por correo dentro de 12 a 14 semanas. Déjeme ver adónde tiene que ir ahora.”



## **Appendix B**

### **Shared/Screening/Safety/Exclusion Questions (Spanish Translation)**



## Appendix B

# Shared/Screening/Safety/Exclusion Questions (Spanish Translation)

Shared Exclusion Questions (Screen 1)	
English	Spanish
Do you have a pacemaker or automatic defibrillator?	¿Tiene un marcapaso o desfibrilador automático?
Are you currently pregnant?	¿Está usted actualmente embarazada?
In the past 7 days, have you had any x-rays or scans that used contrast material such as dyes or barium?	En los últimos 7 días, ¿le han tomado a usted alguna radiografía, tomografía o escáner que usara material de contraste como colorantes o bario?
Do you have any amputations of your legs and feet other than toes?	¿Tiene alguna amputación de las piernas y pies que no sean los dedos de los pies?
Where is the amputation?	¿Se refiere a la cadera derecha, izquierda o las dos caderas?
Screening Questions (Screen 3)	
English	Spanish
Have you removed all jewelry, eyeglasses, hair ornaments, and other objects from your hair and body?	¿Se ha quitado todas las joyas, anteojos, adornos para el pelo y otros objetos del pelo y del cuerpo?
Have you removed wallets, keys, and other objects from all your pockets?	¿Ha sacado su billetera, llaves y otros objetos de todos sus bolsillos?
Do you have any artificial joints, pins, plates, metal suture material, or other types of metal objects in your body?	¿Tiene usted alguna articulación artificial, clavo ortopédico, placa ortopédica, material de metal para puntos de sutura, u otro tipo de objeto de metal en el cuerpo?
Are you using an insulin pump or have insulin lines now?	¿Está usando una bomba de insulina o tiene sondas de insulina ahora?
Do you have an ostomy, such as an ileostomy or colostomy?	¿Tiene usted una ostomía, o sea una pequeña abertura, tal como una ileostomía, abertura en el intestino delgado, o colostomía, abertura en el colon?

Are you wearing a hearing aid now?	¿Está usando _____ audífono/ayuda auditiva ahora?
Have you removed your bra? Wearing a bra may affect the results of your tests.	¿Se quitó el sostén o brasier? No quitárselo puede afectar los resultados de sus pruebas.
“Could you remove it please?”	“¿Puede quitárselo, por favor?”

<b>Safety Exclusion Questions (Screen 3)</b>	
<b>English</b>	<b>Spanish</b>
Do you have a Harrington rod in your spine for scoliosis?	¿Lleva usted en la columna vertebral una barra de Harrington por la escoliosis?
Have you ever fractured your hip, had a hip replacement, or do you have a pin in your hip?	¿Se ha fracturado alguna vez la cadera, le han puesto un reemplazo de la cadera o le han puesto un clavo ortopédico en la cadera?
“Is it your right hip, left hip, or both?”	¿Se refiere a la cadera derecha, izquierda o las dos caderas?

## **Appendix C**

### **Setup Procedures for Body Composition/DXA Room**



# Appendix C

## Setup Procedures for Body Composition/DXA Room

### Unlock Carriage & Rotation Locks (Three Locking Pins)

Technologist/FES

- Unlock the carriage lock located on the left side of the C-arm carriage (around the left gas spring).
- Unlock the C-arm lock.
- Unlock the table locking pin located on the upper left-hand side of the table (front-side of scanner).
- Remove the laminated signs from the C-arm and Hologic computer screen and put them in the supply bin in the belly compartment.

### Remove C-Arm Stabilizer

Technologist/FES

- Remove the Velcro strap from the Stabilizer under the C-arm.
- **Gently** remove the stabilizer from its position.
- The stabilizer is stored in the supply bin in the belly compartment during the stand.
- C-arm must be unbolted from locking pins before any attempt is made to move C-arm.

### Computer and Telephone Equipment Setup

FES

- Set up the ISIS computer equipment.
- Remove Hologic keyboard and mice from box and place on CPU cart.
- Connect all computer equipment on CPU cart to CPU.
- Connect telephone receiver to telephone and plug telephone into wall jack.

## **Power Up the Discovery UPS**

**FES**

**NOTE:** The mobile Discovery System should be shut down only when necessary, primarily during road travel. Other than during road travel, the system should remain powered whenever possible, to avoid warmup delays. Failure to follow this procedure may cause the UPS batteries to discharge and require significant recharge time.

- Verify that the Discovery main breaker is OFF, the UPS main breaker is OFF, and the UPS Stop/RUN Switch is in the STOP position.
- Plug the Discovery Power Module into one of the UPS outlets.
- Plug the UPS into a live power outlet (shore power or motor generator).
- If running on motor generator and generator is off, start the motor generator. If running on shore power, verify that the shore power link is ON.
- Switch on the UPS main breaker and wait 30 seconds. Verify that the AC line light on the UPS is lit.
- Switch the UPS STOP/RUN switch to RUN and wait for the end of the second long beep. Verify that the INVERTER light on the UPS is lit.
- If the UPS batteries are discharged, wait until the batteries are charged. (If you switch on the Discovery A table without waiting for the batteries to charge, you will lose power outage protection.)

## **Power Up the Discovery A Table**

**Technologist**

- Turn on (1) the Discovery circuit breaker located on the back of the left pedestal. The green light should turn on.
- Allow 30 minutes warmup time.
- On the control panel, press the Power button if it is not already on (the Power green indicator light should be illuminated).



## **Power Up the Discovery QDR Computer System**

**Technologist**

- Turn the computer on (button located on front of CPU) and follow the startup procedures under Start of Stand Discovery QDR System Procedures.

## **Room Setup Procedures**

**Technologist**

CPU cart setup and tie-down material removal:

- Remove tie-down strap from CPU cart and from wall anchors.
- Remove wall anchors (2) from walls.
- Store tie-down straps, wall anchors, and computer cozies in the supply bin.
- Check that ISIS CPU, ISIS keyboard, Hologic CPU, and Hologic monitor are still secured to CPU cart.
- Check that Discovery UPS, phantom boxes, and Discovery A table are still secured to the floor.

Supply setup:

- Unpack binders for DXA room and place on basket in grid.
- Unpack grid baskets from box and hang on wall grid.
- Restock containers in grid baskets where needed.
- Place Velcro foot strap in grid basket.
- Calibrate the portable scale and stadiometer.
- Restore trash can and chair to upright positions.
- Store supply bin in MEC belly during a stand.
- Make a final check on room setup.

## **Appendix D**

### **Start of Stand Discovery QDR System Procedures**



# Appendix D

## Start of Stand Discovery QDR System Procedures

### Power Up the Discovery QDR Computer System

- Turn the Hologic computer on (button located on front of CPU).
- The Windows blue screen will appear; click on the QDR icon (soccer ball).
- The Discovery QDR main menu will appear with a dialog box, “A backup of your QDR system’s database has not been performed in \_\_ days.” Follow the procedures listed under system backup to perform a system backup; otherwise, click “No” to proceed.
- The X-ray table will turn on and the Discovery QDR Main Menu will be displayed. Start QC procedures as outlined in Chapter 6.

### System Backup

System backup is the function used to periodically save the system files in case there is a system failure such as a hard drive failure. It does not overwrite any files, such as older backup files. It does not save scan image files.

After Discovery QDR system has been turned on, logon to the APEX software. You will see a dialog box stating, “A backup of your QDR system’s database has not been performed in \_\_ days”

- Insert the current system backup disc into the hard drive.
  - Click “Yes” on the dialog box.
- OR
- Insert system backup disc into the hard drive.
  - Click the System Backup button on the main window. The “QDR System Backup” box will appear.
  - Click on browse. Under the “My Computer” tab find “Removable Disk (D:).” Click on this and then click “OK.” The backup process will begin.

**NOTE:** If you get an error message stating the file does not have enough free space, click “Cancel” and repeat the procedures with a new formatted CD.

This system backup CD should remain on that specific MEC until it is full. If the CD is full, return it to the home office.

Be sure to label the CD cover with “System Backup,” the MEC number “MEC #,” and the date “mm/dd/yyyy.”

A system backup should be performed at the Start of Stand, and prior to any Hologic service or repairs.

## **Formatting CD**

- Minimize the Hologic Discovery QDR application.
- Place a blank CD in the drive.
- Wait for the dialog box to come up to format disc (CD:D).
- Click “Start.”
- Be sure to label the cover of the disc as “formatted” with the date “mm/dd/yyyy.”

## **Archiving Scans**

Archiving scans duplicates scans contained on the computer hard drive and transfers them to the CD.

- Insert a formatted CD into the hard drive.
- Click the “Archive Scans” button in the main window.
- The entry in the archive location path should be “D:\” for the formatted CD.
- Click on the “Unarchived Scans” tab.

- Click on “Select All.”
- Click “Archive Scans” button.
- When transfer results window displays, click “OK.”
- Click on the “Archived Once” tab.
- Click on “Select All.”
- Click “Archive Scans” button.

Label the CD cover with “Archive scans,” the MEC number “MEC #,” and the Stand number.  
Send the CD to the home office.

## **Appendix E**

### **DXA Bone Densitometer Report**





# Appendix E DXA Bone Densitometer Report

## DXA Bone Densitometer Report • NHANES

Stand Number: \_\_\_\_\_ MEC Serial Number: \_\_\_\_\_

Spine Phantom Number: \_\_\_\_\_ MEC Number: \_\_\_\_\_

1) Have there been any software changes?  Yes  No If Yes, indicate:

Old software version: \_\_\_\_\_ New software version: \_\_\_\_\_ Date installed: \_\_\_\_\_

Was software change approved in advance by UCSF?  Yes  No By Whom? \_\_\_\_\_

2) Were there any technologist changes?  Yes  No If Yes, indicate: \_\_\_\_\_

Technologist	Added / Departed	Date of Change	Date of Manufacturer's Training
_____	_____	_____	_____
_____	_____	_____	_____

3) Were there any maintenance/recalibration/repair problems?  Yes  No If Yes, indicate:

Service Performed	Date of Service
_____	_____
_____	_____
_____	_____
_____	_____

4) Additional comments (use reverse side if necessary):

\_\_\_\_\_  
\_\_\_\_\_  
\_\_\_\_\_  
\_\_\_\_\_  
\_\_\_\_\_  
\_\_\_\_\_

Component Lead Health Technologist (CLHT): \_\_\_\_\_

Date: \_\_\_\_\_ Telephone: \_\_\_\_\_

Please complete this form and scan to the home office at the end of the stand. Thank you.

## **DXA Bone Densitometer Service Report**

When the Hologic densitometer is serviced or repaired:

- The Component Lead Health Technologist (CLHT) will complete a “DXA Bone Densitometer Report.”
- Scan a copy of the report to the home office. See laminated cards in the DXA room for names and fax numbers. The home office will send this to the Quality Control Reading Laboratory.
- Scan a copy of the service report completed by the service engineer when the repair or service was made to the home office and to the reading laboratory.
- Put a copy of the service engineer’s report and a copy of the DXA Bone Densitometer in the service report binder kept in the DXA room.

## **Appendix F**

### **Start of Stand QC Scan Checklist**



# Appendix F

## Start of Stand QC Scan Checklist

Stand#: \_\_\_\_\_ Tech ID#: \_\_\_\_\_

Type of Scan	Scan 1	Scan 2	Scan 3	Scan 4	Scan 5	Scan 6	Scan 7	Scan 8	Scan 9	Scan 10
Spine Phantom	<input type="checkbox"/>									
Step Phantom	<input type="checkbox"/>									
Radiographic Uniformity Scan High Air SD = _____ Low Air SD = _____	<input type="checkbox"/>									
Femur/Hip Phantom	<input type="checkbox"/>	<input type="checkbox"/>	<input type="checkbox"/>	<input type="checkbox"/>	<input type="checkbox"/>					
Hologic Slim-Line Whole Body Phantom (Slim-Line WB Phantom #XXXX)	<input type="checkbox"/>	<input type="checkbox"/>	<input type="checkbox"/>	<input type="checkbox"/>	<input type="checkbox"/>					
Hologic Whole Body Phantom (WB Phantom #008) <i>Only at the first stand of the year for each MEC</i>	<input type="checkbox"/>	<input type="checkbox"/>	<input type="checkbox"/>	<input type="checkbox"/>	<input type="checkbox"/>					
Circulating Spine Phantom (HSP Q96) <i>Only at the first stand of the year for each MEC</i>	<input type="checkbox"/>	<input type="checkbox"/>	<input type="checkbox"/>	<input type="checkbox"/>	<input type="checkbox"/>	<input type="checkbox"/>	<input type="checkbox"/>	<input type="checkbox"/>	<input type="checkbox"/>	<input type="checkbox"/>
Circulating Block Phantom (NHANES Block #1) <i>Only at the first stand of the year for each MEC</i>	<input type="checkbox"/>	<input type="checkbox"/>	<input type="checkbox"/>	<input type="checkbox"/>	<input type="checkbox"/>	<input type="checkbox"/>	<input type="checkbox"/>	<input type="checkbox"/>	<input type="checkbox"/>	<input type="checkbox"/>

## **Appendix G**

### **Weekly QC Scan Checklist**



# Appendix G

## Weekly QC Scan Checklist

Week of: \_\_\_\_\_

Tech ID#: \_\_\_\_\_

*Please note: For Day 1 of the first week of each stand, it is not necessary to repeat scans that were done as part of the Start of Stand QC.*

Daily:

	Day 1	Day 2	Day 3	Day 4	Day 5	Day 6 (if applicable)
Type of Scan	Scan 1	Scan 1	Scan 1	Scan 1	Scan 1	Scan 1
Spine Phantom (HASP)	<input type="checkbox"/>	<input type="checkbox"/>	<input type="checkbox"/>	<input type="checkbox"/>	<input type="checkbox"/>	<input type="checkbox"/>
Slim-Line Whole Body Phantom	<input type="checkbox"/>		<input type="checkbox"/>		<input type="checkbox"/>	
Step Phantom (HASP)	<input type="checkbox"/>					
Femur Phantom	<input type="checkbox"/>					
Radiographic Uniformity Scan						
High Air SD = _____	<input type="checkbox"/>					
Low Air SD = _____						



## **Appendix H**

### **Teardown Procedures and Securing the Discovery System for Travel**



# Appendix H

## Teardown Procedures and Securing the Discovery System for Travel

### Power Down the Discovery QDR Computer System

**Technologist**

- Confirm with the component lead health technologist (CLHT) that all files have been copied. If the CLHT cannot confirm this, call Terri Jones. ISIS has to copy all files before the Hologic computer is shut down for travel.
- If all files have been copied, make sure that the main window on the computer appears on the monitor and click “Exit” in the lower right-hand corner of the screen.
- In the Exit QDR System dialog box that appears, select “Exit QDR with shutdown?” and click OK. This will shut down the APEX software and the Windows XP operating system.
- On the Hologic computer CPU, press the on/off switch to power off the computer.

### Power Down the Discovery A Table

**Technologist**

- Press “Center Table” switch on the control panel to position the C-arm and table in the middle of its range.
- Turn off the Discovery System by pressing the power switch on the control panel. The green indicator in the power button should go out.
- On the back of the left pedestal, turn the circuit breaker switch to off (0).

### Turn Off the Discovery UPS

**Technologist**

- Switch the UPS STOP/RUN switch to STOP.
- Switch off the UPS main breaker.

## Secure the C-Arm Stabilizer

Technologist/FES

- **Carefully complete the following steps.** The stabilizer fits snugly between the C-arm and the table but it should not be forced.
- Place the notched end of the stabilizer on the bottom of the C-arm (tank end) and pivot the top toward the top of the C-arm.
- Position the stabilizer so that the top and bottom foam pads are wedged between the top of the tank cover and the bottom of the C-arm. Be sure not to cover up the laser box.
- The C-arm must be vertical.
- Secure stabilizer by clamping the Velcro strap tightly around the top of the C-arm and fasten it to the stabilizer pad.

## Secure Carriage and Rotation Locks (3 Total)

Technologist/FES

- The table locking pin is located on the upper left-hand side of the table (front side of scanner).
- Turn the locking pin handle downwards until the plunger releases and locks into place. (Budge table back and forth if locking pin does not engage at centered position.)
- The C-arm carriage lock is located on the left side of the C-arm carriage (around the gas spring).
- Turn the locking pin handle until the plunger releases and locks into place.
- The carriage lock is located on the lower left side of the carriage.
- Turn the handle until the plunger releases and locks into place.
- Put laminated signs on C-arm and over the Hologic computer screens that indicate that the locking pins are in position.

## Room Teardown Procedures

## Technologist

- Follow specific ISIS instructions for teardown of computer equipment.
- Remove wall anchors and tie-down straps from supply bin stored in MEC belly.
- Attach all wall anchors to the walls.
- The FES will attach the long end of the strap to the wall anchor on the telephone wall and will attach the ratchet strap to the opposite corner wall anchor.
- Pack manuals into DXA supply bin.
- Consolidate supplies in grid baskets where possible, and pack grid baskets with supplies into DXA supply bin.
- Place extra paper roll in supply bin.
- Pack up portable scale and stadiometer.
- Do not disconnect the telephone from phone jack and receiver. Wrap rubber bands around the phone and receiver to secure for travel.
- Store packed DXA supply bin on floor. Nothing should be stored on the table.
- Make sure laminated signs are on Hologic monitor and C-arm: **“Locking pins are in position. Do not attempt to turn on DXA machine until the locking pin is removed.”**
- Anchor computer cart with nylon strap around cart legs and tighten ratchet.
- Check that the ISIS CPU, the ISIS keyboard, the Hologic CPU, and the Hologic monitor are all secured to the computer cart.
- Check that the UPS, the phantom boxes, and the DXA are secured to the floor.
- Turn room chair upside down.
- Turn trash can on its side.
- Make final check on pickup of the room with the chief technologist.

## **Room Teardown Procedures**

## **Technologist**

- Disconnect ISIS monitor from CPU.
- Remove ISIS monitor from cart and place in box with packing material.
- Disconnect both mice and Hologic keyboard from CPU.
- Pack the mice and the Hologic keyboard into a box with packing material.
- Place all packed boxes on the floor. Nothing should be stored on the bed of the DXA table.
- Unplug all electrical equipment.

## **Appendix I**

### **Power Failure Procedures for DXA**





# Appendix I

## Power Failure and Emergency Procedures for DXA

### For a Power Failure

Shutting down:

- If the system was inoperative when the power failure occurred, assist the SP from the table. (The On/Off switch will be inoperative at this time.)
- Turn off the computer.
- Turn off the circuit breaker located on the back of the left pedestal (the green indicator should already be off due to the power failure).

After power is restored:

- After waiting for a few minutes for the power to stabilize, turn on the circuit breaker (the green light should turn on).
- Turn on the computer.
- Perform start of session procedures.

If equipment fails while in operation:

- On the control panel, press the red Emergency Stop Button. (The table and the C-arm immediately stop moving, and the X-rays and laser turn off.)
- Assist the SP off the table.
- Turn off the circuit breaker.
- Disconnect the power cord from the AC outlet (if possible).
- Call Hologic customer service.

If AC power has been turned off:

- If necessary, plug the power cord into the AC outlet.
- Place the circuit breaker in the on (1) position (the green light should illuminate).
- Perform the start of session procedures.

**Appendix J**  
**Script for Parents**



## Appendix J Script for Parents



### NHANES Dual-Energy X-Ray Absorptiometry (DXA) Scan

As part of the National Health and Nutrition Examination Survey exam, your child will have a DXA scan of the whole body. This scan provides information on the amounts of fat, lean tissue (like muscle), and bone in the body. The scan uses x-ray energy which is also known as radiation.

The amount of radiation your child will be exposed to is extremely small. It is less than the amount of natural background radiation the average person living in the United States is exposed to every day, which is about 8 microsieverts (uSv). It is also less than the radiation exposure from an airplane flight across the United States, which is about 30 uSv. The Sievert is a unit of effective dosage radiation.

Depending on his or her age, your child will receive a radiation dose of 4.2 to 4.8  $\mu$ Sv during the whole body scan.

The information from your child's DXA scan will be used with other NHANES information such as height and weight to help doctors and other health professionals to better deal with health problems that may affect children.

Thank you for participating in NHANES!

## Densitometría ósea para NHANES

Como parte de la Encuesta Nacional de Examen de Salud y Nutrición, a su niño se le hará una densitometría ósea de todo el cuerpo, DXA por sus siglas en inglés. Este examen proporciona información acerca de la cantidad de grasa, tejidos sin grasa (como músculos) y los huesos del cuerpo. Este examen usa energía de rayos X, también conocida como radiación.

La cantidad de radiación a la que estará expuesto su niño es mínima. Es menos que la cantidad de radiación natural a la que, en promedio, se expone una persona todos los días en Estados Unidos, la cual es aproximadamente 8 microsieverts (uSv). Es también menos que la exposición a la radiación en un viaje en avión por Estados Unidos, la cual es aproximadamente 30 uSv. El sievert es una unidad que mide la dosis efectiva de radiación.

Dependiendo de la edad, el niño recibirá una dosis de radiación de 4.2 a 4.8  $\mu$ Sv durante todo el examen.

La información de la densitometría ósea de su niño se usará con otra información de NHANES, como la estatura y el peso, con el fin de ayudar a médicos y a otros profesionales de la salud a tratar mejor los problemas de salud que pueden afectar a los niños.

¡Gracias por participar en NHANES!