



Centers for Disease
Control and Prevention
National Center for
Health Statistics

2021 Body Composition Procedures Manual

May 2021



National Health and Nutrition Examination Survey

Table of Contents

<u>Chapter</u>		<u>Page</u>
1	Overview of Body Composition	1-1
	1.1 Overview of Dual Energy X-Ray Absorptiometry	1-1
	1.2 Risks	1-2
	1.3 Personnel.....	1-2
	1.4 Problems with the Exam	1-2
2	Equipment/Supplies/Materials.....	2-1
	2.1 Description of Equipment for DXA	2-1
	2.1.1 Hologic Horizon QDR.....	2-1
	2.1.2 Horizon QDR System Operations.....	2-3
	2.1.3 Supplies	2-3
	2.1.4 Radiation Badges	2-4
	2.2 Maintenance and Repair of Equipment for DXA	2-4
	2.2.1 Maintenance and Repair Reports	2-5
	2.3 Calibration of Equipment for DXA.....	2-7
3	Protocol.....	3-1
	3.1 Introduction to the DXA Examination.....	3-1
	3.2 Explanation of the DXA Examination.....	3-1
	3.3 Hologic Horizon A Table and System Operation	3-2
	3.3.1 Startup Procedures for Hologic Horizon A Table (Start of Session)	3-2
	3.3.2 End of Session Shutdown Procedures for Horizon A System	3-4
	3.3.3 End of Day Shutdown Procedures for Horizon A System	3-5
	3.4 Examinee Preparation for the DXA Examination	3-5
	3.4.1 Measurement of Weight and Height to Determine Body Mass Index	3-5
	3.4.2 Preparing the SP	3-7

<u>Chapter</u>		<u>Page</u>
3.5	Whole Body DXA Scan	3-9
	3.5.1 Selecting an SP	3-9
	3.5.2 Selecting the Type of Scan	3-10
	3.5.3 Positioning the SP	3-11
	3.5.4 Reflection Positioning.....	3-13
	3.5.5 Completing the Scan	3-15
	3.5.6 DXA Scan Data	3-17
4	Data Entry Screens.....	4-1
	4.1 Shared Exclusion Questions.....	4-1
	4.2 Weight/Height Entry Screen	4-6
	4.3 Screening and Safety Questions.....	4-8
	4.4 DXA Whole Body Data Capture Screen.....	4-10
	4.5 DXA Component Status.....	4-16
	4.6 Session Pickup List	4-19
	4.7 Session Preview Report.....	4-20
	4.8 Room Log	4-21
	4.9 Close Exam.....	4-22
5	Referrals and Report of Findings	5-1
	5.1 Observation Referrals.....	5-1
	5.2 Report of Findings for DXA	5-3
	5.2.1 Sample Preliminary Report of Findings	5-4
6	Quality Control.....	6-1
	6.1 Equipment and Room Setup Checks.....	6-1
	6.1.1 Daily.....	6-1
	6.1.2 Three Times Per Week (1st, 3rd, and 5th Days of Workweek).....	6-2
	6.1.3 Weekly	6-2
	6.1.4 Start of Stand.....	6-2
	6.1.5 End of Stand	6-3

<u>Chapter</u>		<u>Page</u>
6.2	Procedures for Completing QC Scans.....	6-3
6.2.1	Hologic Anthropomorphic Spine Phantom (HASP)	6-3
6.2.2	Step Phantom	6-9
6.2.3	Radiographic Uniformity Test	6-12
6.2.4	Slim-Line Whole Body Phantom	6-17
6.2.5	Circulating HASP (HSP Q-96)	6-21
6.2.6	Circulating Block Phantom (Hologic Block Phantom NH #1)	6-22
6.2.7	Hologic Whole Body Phantom #008.....	6-22
6.3	QC Scan Checklists.....	6-24
6.3.1	Instructions for Completing the Weekly QC Scan Checklist	6-25
6.3.2	Instructions for Completing the Start of Stand QC Scan Checklist.....	6-25
6.4	Data Entry Screens for QC on Equipment	6-25
6.4.1	QC Daily Checks	6-26
6.4.2	QC Weekly Checks.....	6-27
6.4.3	QC Start of Stand Checks	6-28
6.4.4	QC Yearly Checks	6-29
6.4.5	QC End of Stand Checks.....	6-30
6.4.6	Incomplete QC Checks	6-31

Appendixes

A	DXA Scripts	A-1
B	Shared/Screening/Safety/Exclusion Questions (Spanish Translation)	B-1
C	Setup Procedures for Body Composition/DXA Room	C-1
D	Start of Stand Hologic Horizon QDR System Procedures	D-1
E	DXA Bone Densitometer Report.....	E-1
F	Start of Stand QC Scan Checklist.....	F-1

<u>Appendixes</u>		<u>Page</u>
G	Weekly QC Scan Checklist.....	G-1
H	Teardown Procedures and Securing the Hologic Horizon QDR System for Travel.....	H-1
I	Power Failure Procedures for DXA	I-1
J	Script for Parents	J-1

Table

1-1	Pregnancy status information for body composition by age and gender	1-2
-----	---	-----

Figures

2-1	Hologic Horizon QDR.....	2-1
2-2	Horizon QDR table control panel.....	2-2
2-3	Laser warning label.....	2-3
2-4	Laser locator label.....	2-3
3-1	Hologic Horizon A table showing power indicator	3-3
3-2	Horizon A Table instrument control panel.....	3-3
3-3	Scan table pad (top view).....	3-8
3-4	Correctly positioned whole body scan.....	3-12
3-5	Reflection positioning.....	3-14
3-6	Data displayed after analysis (1).....	3-17
6-1	Spine phantom registration mark.....	6-4
6-2	Spine phantom and laser crosshair position	6-5
6-3	Slim-Line whole body phantom fully assembled.....	6-18

<u>Figures</u>		<u>Page</u>
6-4	Layout of whole body phantom—top view	6-24
6-5	Layout of whole body phantom—side view	6-24

Exhibits

3-1	Horizon A main menu.....	3-4
3-2	Horizon A screen with option of system backup.....	3-4
3-3	Exiting the Horizon A system.....	3-5
3-4	Selecting “perform exam”	3-9
3-5	Patient Selection screen.....	3-10
3-6	Operator field for initials.....	3-10
3-7	Scan Selection screen	3-11
3-8	Whole Body Scan Parameters screen.....	3-14
3-9	Whole body scan image.....	3-16
3-10	Exit Exam/New Scan Window box.....	3-16
4-1	Shared exclusion questions.....	4-1
4-2	Exclusion from DXA due to pregnancy status.....	4-2
4-3	Shared exclusion questions without pregnancy question.....	4-3
4-4	Exclusion from DXA due to data effect.....	4-4
4-5	Exam status “not done” due to data effect	4-4
4-6	Response options for question “Where is the amputation?”	4-5
4-7	Weight/Height Entry screen	4-6
4-8	Weight/height information transferred from body measures	4-6
4-9	Entering the weight/height information into the screen.....	4-7

<u>Exhibits</u>		<u>Page</u>
4-10	Selection for high-power scan	4-7
4-11	Screening questions	4-8
4-12	Screening question highlighted with options.....	4-9
4-13	Whole body data capture (1).....	4-10
4-14	Whole body data capture with reflection positioning	4-11
4-15	DXA data capture (2).....	4-12
4-16	DXA data capture (comments on scan).....	4-13
4-17	DXA data capture (scan not completed)	4-14
4-18	Whole Body Data Capture screen.....	4-15
4-19	HP error message	4-15
4-20	DXA component status (required comments).....	4-16
4-21	DXA component status.....	4-17
4-22	Session pickup list.....	4-19
4-23	Session preview report.....	4-20
4-24	Room log for body composition.....	4-21
4-25	Close exam.....	4-22
5-1	Menu to select observation referral	5-1
5-2	Pick list of SPs in current session.....	5-2
5-3	Observation referral in body composition.....	5-2
5-4	Observation referral from other components in Clinician's Referral Review box	5-3
5-5	Sample report of findings for body composition	5-4
6-1	Horizon A main menu.....	6-3

<u>Exhibits</u>		<u>Page</u>
6-2	Daily QC Setup box	6-4
6-3	System self-test.....	6-5
6-4	System test passed	6-6
6-5	Auto QC passed.....	6-6
6-6	Spine Phantom QC—plot for bone mineral density (BMD).....	6-7
6-7	Spine phantom QC—plot for bone mineral content (BMC).....	6-8
6-8	Step Phantom Setup window.....	6-9
6-9	Step phantom scan	6-10
6-10	Step phantom evaluation completed successfully.....	6-11
6-11	Step phantom QC completed, press Continue	6-11
6-12	Selecting radiographic uniformity from the patient list	6-12
6-13	Operator box for initials.....	6-13
6-14	Selecting Whole Body in the Select Scan Type screen.....	6-13
6-15	Radiographic uniformity Scan Parameters screen.....	6-14
6-16	Radiographic uniformity test.....	6-14
6-17	Selecting radiographic uniformity for SD results.....	6-15
6-18	Low air global stats SD	6-16
6-19	High air global stats SD	6-16
6-20	Selecting Slim-Line WB phantom scan	6-19
6-21	Operator box for initials.....	6-19
6-22	Selecting Whole Body in the Select Scan Type screen.....	6-20
6-23	Slim-Line Scan Parameters screen.....	6-20

<u>Exhibits</u>		<u>Page</u>
6-24	Quality Control Reminder Message box	6-25
6-25	Utilities menu to select quality control	6-26
6-26	Quality control logon	6-26
6-27	Quality control daily checks	6-27
6-28	Quality control weekly checks	6-27
6-29	Quality control start of stand checks (1)	6-28
6-30	Quality control start of stand checks (2)	6-29
6-31	Quality control yearly checks	6-30
6-32	Quality control end of stand checks	6-30
6-33	Quality control incomplete entry	6-31

1. Overview of Body Composition

Body composition and bone health will be evaluated in the current National Health and Nutrition Examination Survey (NHANES) by anthropometry and dual energy X-ray absorptiometry (DXA). These methods will be used to (1) monitor secular trends in overweight prevalence; (2) describe the prevalence of obesity; and (3) examine the relationship between overweight and obesity and other examination measures, including blood pressure, glucose intolerance, and a battery of indicators for cardiovascular disease.

1.1 Overview of Dual Energy X-Ray Absorptiometry

DXA was included for the first time in the NHANES during NHANES III: 1988-94. Femoral bone mineral density was assessed at that time using pencil-beam bone densitometers (Hologic QDR 1000). In 1999-2006, the DXA component included acquisition of whole body DXA scans using Hologic QDR 4500A fan-beam bone densitometers. In 2011-2018 the DXA scans were acquired using Hologic Discovery A fan-beam bone densitometers. Since 2019, the DXA scans are acquired using Hologic Horizon A fan-beam bone densitometers. Scans of the proximal femur and anteroposterior (AP) or lumbar spine were collected in 2005-10, 2013-14, and 2017-2020.

The NHANES whole body DXA data will be used to examine age, sex, and racial/ethnic differences in body composition (bone mineral, lean soft tissue, and fat mass) during the life cycle to explore the relationship between body composition and behavioral factors such as diet and physical activity and physiologic factors such as hypertension, diabetes, cardiovascular disease, and muscle strength. All individuals 8-59 years are eligible for the whole body scan, with the exception of pregnant females.

The DXA Whole Body scan will be completed on all individuals 8 through 59 years. Pregnancy status will be assessed on all females 12 through 59 years and menstruating 8- to 11-year-olds. If the result of the pregnancy test is positive, the SP will be excluded from the entire exam. If a pregnancy test for an SP who is 8-17 years old comes back positive, a second test will be done for confirmation. In addition, women aged 12 through 59 years will be asked to self-report their pregnancy status and will be excluded if they respond “Yes” or “Don’t Know,” even if the pregnancy test was negative. Self-report on pregnancy status for 12- to 15-year-old females will be

asked in the Clinician’s Exam. Females 8 through 11 years of age will not be asked about pregnancy status (see Table 1-1).

Table 1-1. Pregnancy status information for body composition by age and gender

Pregnancy status	Age	Gender
Pregnancy status—urine test	12-59 years	Females
Pregnancy status—urine test	Menstruating 8-11 years	Females
Pregnancy status—self report	12-59 years	Females
Pregnancy status—self report (Asked in Clinician's Exam)	12-15 years	Females
Pregnancy status—self report (Shared Exclusion Question)	18-59 years	Females

1.2 Risks

The risk from DXA scans is low. The average effective dose to an individual in the United States from background radiation is approximately 3600 microsieverts (μSv) per year. A standard diagnostic X-ray of the spine, for example, delivers an effective radiation dose of 1100 μSv . The total estimated effective radiation dosage in μSv is 4.2 to 5.2 for the whole body scan.

1.3 Personnel

A certified radiology technologist will conduct all DXA scans.

1.4 Problems with the Exam

Under no circumstances should a whole body scan be repeated. If a problem occurs during any of the scans, it should be documented in the Integrated Survey Information System (ISIS) Data Capture screen and/or an Unusual Field Occurrence (UFO) if necessary.

2. Equipment/Supplies/Materials

2.1 Description of Equipment for DXA

2.1.1 Hologic Horizon QDR

The Hologic Horizon QDR (Figure 2-1) is a fan beam X-ray bone densitometer, which uses two different energy levels produced by an energy tube to estimate bone mineral content (BMC) and bone mineral density (BMD). The Horizon QDR uses a low level of X-rays, and under standard operating conditions, the entrance dose to the examinee for a whole body scan is less than 1 mR¹ (a standard X-ray is approximately 35 mR).

Figure 2-1. Hologic Horizon QDR



¹ One mR is a milliroentgen, or one-thousandth of a roentgen, the measurement of energy produced by Gamma or X-ray radiation in a cubic centimeter of air.

The densitometer produces ionizing radiation in the form of X-rays and uses laser radiation to position scans, although the radiation exposure is so low that no shielding of the room or of health technologists is required.

The X-ray ON indicator is an amber light located in the upper right corner of the instrument control panel (see Figure 2-2). When the X-ray lamp is lit, X-rays are being produced.

The **Emergency Stop Button** is a round red button at the right end of the Horizon A table control panel that is used for emergencies. When this button is pressed, the X-rays and the table are disabled and scanning stops immediately. Pulling on the button resumes normal operation.

1. **Press down** on the button to **stop** the scan.
2. **Pull up** on the button to **resume normal operation**.

Figure 2-2. Horizon QDR table control panel



Laser Positioning. The Laser-On Lamp is an amber light above the laser switch on the Horizon A table control panel. It alerts the user that the laser position indicator is active. The laser position indicator unit produces 1 mW laser emission. The examinee and technologist should avoid looking directly into the beam or placing reflective objects in the path of the beam.

The Horizon QDR table includes a laser safety feature that turns the laser off if the distance between the top (right side) of the table is less than approximately 15.5 inches from the laser light spot. This feature is there to help prevent shining the laser light in the examinee's eyes. Figure 2-3 shows the laser warning label located on the scanner arm.

Figure 2-3. Laser warning label

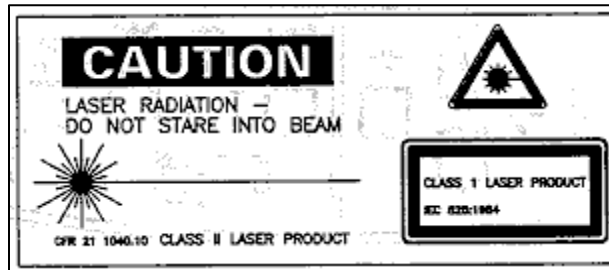

Arrows marked “Laser Aperture” mounted on the scanner arm note the location of the laser beam. Figure 2-4 shows the laser locator label.

Figure 2-4. Laser locator label

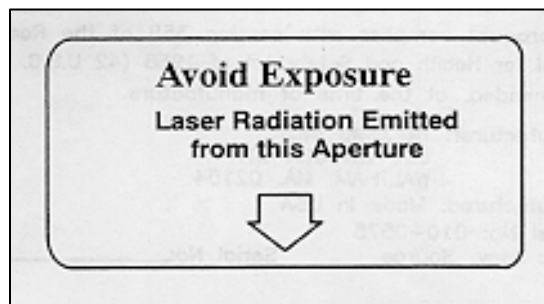

2.1.2 Horizon QDR System Operations

See Section 3.3 in Chapter 3 for Startup and Shutdown Procedures for the Horizon QDR System. See Appendix I for Power Failure Procedures.

2.1.3 Supplies

- Disposable exam paper is used for all sample persons (SPs). A clean layer of the paper is placed on the exam table between each SP.
- A Velcro strap is used to prevent movement of the feet during the whole body scan. This is tied around the SP’s ankles with his or her toes pointing up.
- A radiolucent contour pillow may be used to support the head for SPs who have trouble lying flat due to back problems or difficulty breathing.

- Foam wedges can also be used to support the head, or they may be placed under the knees for SPs having difficulty lying flat.
- Foam sponges may be used to separate the hands from the torso during the whole body scan, or between the feet to prevent any overlapping.

2.1.4 Radiation Badges

Health technologists operating the densitometers are required to wear radiation badges for densitometry processing. A badge specific for each mobile examination center (MEC) is placed in the room on the computer cart beside the densitometer. A control badge for each team is kept in a radiation-free area on the MEC, such as the staff lounge. This control badge travels with the team to each stand.

2.2 Maintenance and Repair of Equipment for DXA

If the radiology technologist notes a problem with the system and needs to contact Hologic for repair, the technologist should notify the MEC manager and the home office component lead of the problem. Be sure to document the call in the Hologic Call Log. The Hologic contact number and other important information are listed below:

- Call Hologic customer support at 1-800-321-4659.
- Provide the model number and the serial number for your machine.
 - Model number for all MECs is Hologic Horizon QDR.
 - Serial number for MEC 1 = 301975M.
 - Serial number for MEC 2 = 301983M.
 - Serial number for MEC 3 = 301832M.
- Provide the location of the MEC at the time the service will be needed.
 - Confirm with the Hologic person making the reservation and with the Hologic Service Technician the location of the MEC. They often confuse this with the last place the MEC was when it was serviced.

2.2.1 Maintenance and Repair Reports

When the Hologic densitometer is serviced or repaired, it is the responsibility of the radiology technologist who first noted the problem to confirm that all required reports are completed, stored, and sent to the appropriate people. These reports include the following:

2.2.1.1 Regular Reports

1. Field Service Report (FSR):

When the Hologic densitometer is serviced or repaired:

- The Hologic service technician will complete an FSR and will send the FSR to the Facilities and Equipment Specialist (FES) or radiology technologist.
- The FES will email the FSR to the home office component lead and will copy the radiology technologist.
- The radiology technologist will confirm that the FSR was sent to the home office component lead and will put a copy of the FSR in the service report folder on the DXA Integrated Survey Information System (ISIS) computer.

2. DXA Bone Densitometer Report (BDR):

When the Hologic densitometer is serviced or repaired, the radiology technologist will do the following:

- Complete a BDR (located in a folder on the ISIS DXA computer);
- Send an electronic copy of the DXA BDR to the DXA component lead; and
- Place an electronic copy of the DXA BDR in the service report folder located on the DXA ISIS computer.

The DXA component lead will send the report to the DXA Project Officer at NCHS and the DXA Quality Control Reading Laboratory.

3. Hologic Customer Service Log (Call Log):

Each time the Hologic densitometer is serviced or repaired and a call is made to Hologic, the radiology technologist will do the following:

- Enter the date, description of the problem, the solution, and his or her initials for each call made for problems with the densitometer.
- Scan and send an **electronic copy** of the Call Log to the home office at the end of the stand, which will send it to NCHS and the Quality Control Reading Laboratory.

2.2.1.2 Preventive Maintenance Reports

Preventive Maintenance (PM) will be completed on each of the densitometers twice a year.

The first PM of the year will be completed **prior to the first stand of the year** for each of the MECs (January/February). This will require coordination between the home office, FES, and the radiology technologist on the MEC where the PM is to be completed. Because this PM will be completed prior to the setup at that stand, the home office will schedule a PM for a location where the survey will go next.

The second PM of the year will be completed approximately 6 months following the previous one (July/August). The PM will be scheduled prior to setup and will also require coordination between the home office, FES, and the radiology technologist on the MEC where it is to be completed. The coordination, responsibility, and followup are the same as for the first PM.

The reports associated with PM include the following:

1. Field Service Report:

The FSR for the PM is the same form used for regular service. Note that if you have to schedule a service for another problem with the machine, the Hologic service technician will complete two separate FSRs—one for the PM (FSR-PM) and one for the issue with the machine or software.

2. Preventive Maintenance Checklist (PMC):

When the PM service is completed by the Hologic service technician:

- The **Hologic service technician** will complete the PMC and email it to the FES;
- The **FES** will email the PMC to the home office component lead and will copy the radiology technologist; and
- The radiology technologist will confirm that the PMC was sent to the home office component lead and will put a copy of the PMC in the service report folder on the DXA ISIS computer.

3. Radiation Measurement Report (RMR):

When the PM service is completed by the Hologic service technician:

- The **Hologic service technician** will complete the RMR and email it to the FES;
- The **FES** will email the RMR to the home office component lead and will copy the radiology technologist; and
- The radiology technologist will confirm that the RMR was sent to the home office component lead and will put a copy of the RMR in the service report binder kept in the DXA room.

The home office DXA component lead will send the PM reports and checklist (FSR, FSR-PM, PMC, and RMR) for each stand to the NCHS DXA Project Officer and the Quality Control Reading Laboratory.

2.3 Calibration of Equipment for DXA

Refer to Chapter 6 for complete instructions regarding calibration and quality control scanning procedures.

3. Protocol

3.1 Introduction to the DXA Examination

The technologist should briefly explain the examination when the sample person (SP) is brought into the room. The exam should be explained in more detail as it is being conducted. The objective is to inform the SP about the exam and to position the SP as quickly as possible. Below is a suggested introductory script, but the examiner should use his or her own words for this explanation. This is an explanation, not a standard script, so the technologist may adjust the explanation to the level of understanding of the examinee.

Suggested introduction to component (English version):

“In this room, we are going to be doing a scan of your body that will tell us about your body composition. I will explain in more detail as I do the exam. Please have a seat up here on the table and get as comfortable as possible. I am going to ask you a few questions before I start the exam.”

3.2 Explanation of the DXA Examination

The technologist is scanning the ID wristband of the examinee during the explanation of the exam. The explanation should be used only as a guideline and the technologist should adjust the explanation to the level of understanding of the SP. The script used for an 8-year-old will be different from the script used for a 59-year-old. The script below provides a suggested explanation of the whole body scan.

Suggested explanation of whole body DXA scan (English version):

“For this examination, I will be doing a scan of your body with this machine. It will tell us about your body composition. Now please lie down on the table and I will position you for the scan. I’m going to pull up on your shoulders to straighten you. I will position your arms and feet correctly for the scan and then wrap these Velcro straps loosely around your ankles to hold them in place. The scan will take about 3 minutes to complete and you will not feel anything except for the table movement. As the machine scans your body, the table will move up and down and back and forth. This overhead arm (the C-arm) will also be moving. In order to receive a good quality scan, it is important that you lie perfectly still during the scan and do not talk.”

Suggested explanation after completion of the scan (English version):

“Please stay lying down until I have moved the overhead arm out of the way. Now you can sit up. You will receive the results in the mail in 12-16 weeks. Let’s find out where you go next.”

3.3 Hologic Horizon A Table and System Operation

The Horizon A system should be turned on at the beginning of the day and off at the end of each session for that day. See Appendix C for setting up the Horizon A table for operations. Routine Horizon A system startup procedures for the beginning of a session are outlined below in Section 3.3.1. See Appendix H for securing the Horizon A table for travel. Routine shutdown procedures are outlined in Section 3.3.2. See Appendix I for power failure procedures for DXA.

3.3.1 Startup Procedures for Hologic Horizon A Table (Start of Session)

Confirm these settings first.

- Verify that the green indicator on the back of the left pedestal is on. (This light indicates that the system is receiving AC power.) This should be left on at all times unless a power failure occurs. See Figure 3-1 below. If the green light is not on, check and see if the UPS (uninterruptible power supply) is plugged into the outlet; if not, plug it in and then make sure the circuit breaker switch is in the on (1) position. If the green indicator does not light up, notify the Facilities and Equipment Specialist (FES).
- On the control panel, the POWER green indicator light should be on. If not, press the POWER button to turn it on. See Figure 3-2.
- The Hologic COMPUTER POWER switch located underneath the workstation should be ON. (This is left ON to allow network backup overnight.)

Figure 3-1. Hologic Horizon A table showing power indicator

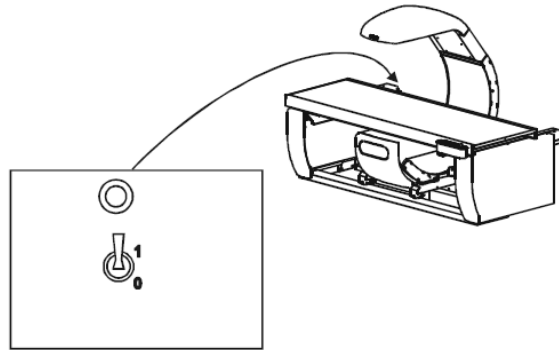

Description	Function
Circuit Breaker	Turns the power to the Discovery system off (0) and on (1).
Indicator	Glowes green when the circuit breaker is in the on (1) position.

Figure 3-2. Horizon A Table instrument control panel



Turning the Hologic Horizon A System ON (Start of Session Routine Procedure):

- See Exhibit 3-1 for the Hologic Horizon A Main Menu. If the QDR database has not been backed up, a dialog Windows box will appear: “A backup of your QDR system’s database has not been performed in # days! Do you want to perform a system backup now?”
- Click Yes, if you want to perform the system back-up at this time.
- Click No, if you want to complete the back-up at a later time. See Exhibit 3-2 for the screen that is displayed when a back-up is required.

Note: DO NOT log on to ISIS until the startup for the Hologic computer has been completed. If the ISIS computer is opened before the Hologic computer, a message will be displayed after the scan is completed: “Unable to find drive specified.” If you get this message, call the ISIS Help Line.

Open the DXA/Body Composition application on the ISIS screen.

Exhibit 3-1. Horizon A main menu

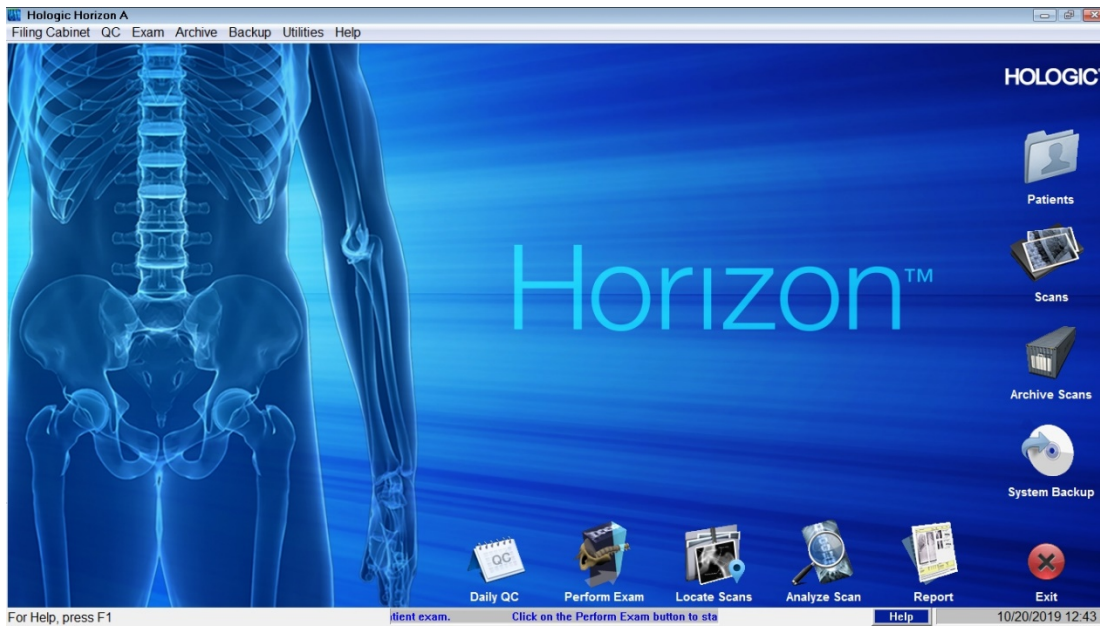
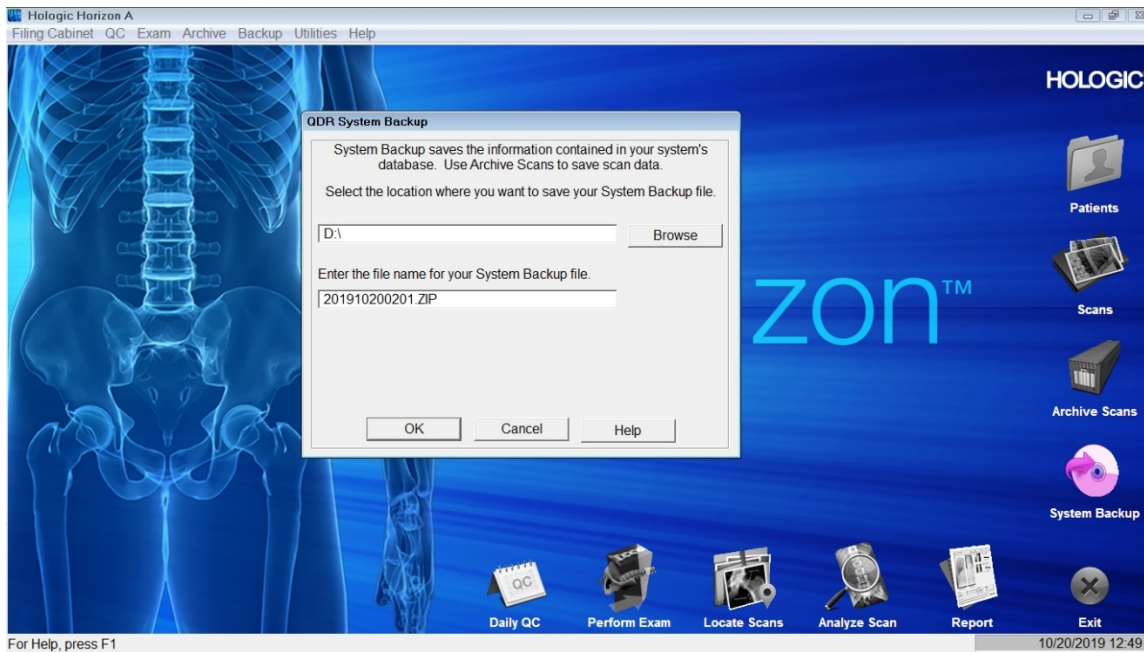

Exhibit 3-2. Horizon A screen with option of system backup



3.3.2 End of Session Shutdown Procedures for Horizon A System

Close the DXA/Body Composition application. The screen should display the Horizon QDR Main Menu. (See Exhibit 3-1 above.)

3.3.3 End of Day Shutdown Procedures for Horizon A System

- Click Exit (bottom right corner).
- Exhibit 3-3 shows the window that will be displayed at shutdown. It is defaulted to “Exit QDR with Shutdown”.
- Select “Exit QDR without Shutdown” and click OK. Leave the monitor at blue screen. The Hologic computer should always be kept on through the duration of the stand.
- Reboot ISIS.

Exhibit 3-3. Exiting the Horizon A system

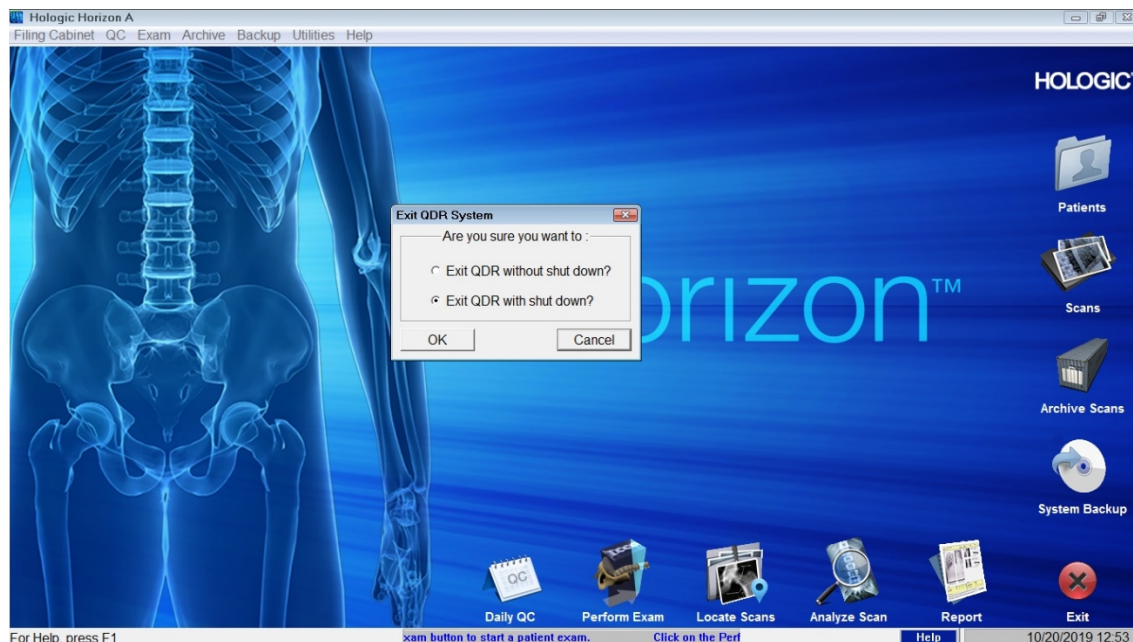

3.4 Examinee Preparation for the DXA Examination

The SP should be logged in to ISIS as soon as possible after they have entered the room.

3.4.1 Measurement of Weight and Height to Determine Body Mass Index

After answering the Shared Exclusion Questions, the next screen displayed will be the Weight/Height Entry screen. If the SP was in the anthropometry (body measures) component prior to this test, the weight and height will already be uploaded and displayed on the ISIS screen, along with the component it transferred from (e.g., body measures). If the information is not displayed,

you will need to measure the SP's weight and height using the floor scale and stadiometer in the room. The system will use the weight and height measurements to calculate the body mass index, which will determine whether the SP needs the high-power whole body scan or not. The same precision to take the weight and height measurements in the anthropometry component must be used in this component.

3.4.1.1 Weight

Follow these steps to take the SP's weight:

1. Make sure the scale weight is in kilograms by checking the switch on the underside of the digital display.
2. Place the scale on the floor.
3. Switch on the scale by gently pressing the blue ON button. Have the SP remove their shoes and any outer clothing such as sweaters, jackets, etc.
4. Wait until the display 0.0 kg and the Ready/Complete symbol O appear on the digital display. Have the SP step on the scale with their feet positioned in the center.
5. Ask the SP to stand straight and remain still.
6. The scale will display “----” while it is taking the SP's measurement. Record the weight in kilograms in the weight field.
7. Ask the SP to step off the scale. The scale switches off automatically after 45 seconds of inactivity.

If the SP's weight is **more than 450 pounds**, they will be excluded from the entire body composition component due to the weight limitation of the table. However, the application will still ask you to obtain their height. After you enter the height, the SP will be excluded from the exam, and the exam status will be set to “Not Done” due to “weight limitation on equipment.”

3.4.1.2 Height

Follow these steps to take the SP's height:

1. Ask the SP to remove their shoes if necessary.
2. Place the stadiometer a few inches away from the wall. Check to be sure the measurement column on the stadiometer is completely inserted into the floor piece. Pull

the sliding top bar section up and open the head piece to allow the SP to step under the head piece.

3. Ask the SP to stand erect on the floorboard with their back to the vertical piece of the stadiometer and the wall. The SP should not be leaning against the stadiometer.
4. Ask the SP to evenly distribute their weight on both feet. Their heels should be placed together with their feet pointed slightly outward at a 60° angle. Their arms should hang freely by the sides of their trunk, with their palms facing their thighs.
5. Position their head in the Frankfort horizontal plane. The SP's head is in the Frankfort plane when the horizontal line from their ear canal to the lower border of the orbit of their eye is parallel to the floor and perpendicular to the vertical backboard. Many people will assume this position naturally, but for some it may be necessary to make a minor adjustment. If required, gently tilt their head up or down until proper alignment is achieved with their eyes looking straight ahead. Lower the headpiece snugly to the crown of the SP's head with sufficient pressure to compress their hair. Once correctly positioned, ask the SP to inhale deeply and stand fully erect without altering the position of their heels.
6. Hold the top sliding bar in place at the junction and ask the SP to step out away from the stadiometer.
7. Record the measurement in centimeters (measurements printed on right side of bar) at the orange line on the measuring bar.

If the SP is **greater than 6'5"**, they will be excluded from the whole body scan due to limitations of the table. The exam status will be set to "Not Done" with the comment "Exceeds height limitation."

3.4.1.3 Body Mass Index

After entering the SP's weight and height, the ISIS application will calculate their body mass index (BMI). If the SP is a **male with a BMI \geq 31**, or a **female with a BMI \geq 32**, they will be selected for the high power option. A pop-up message will display that reads, "This SP has been selected for the HP Whole Body Scan." Be sure to select this scan under the scan type in the Hologic Horizon A system. The high-power whole body scan will be performed only on SPs 18 years or older.

3.4.2 Preparing the SP

The next screen will have the screening and safety exclusion questions. Go through the questions with the SP, and then have them remove all metal objects from their body (jewelry, belts, snaps,

underwire bras). If the SP has small objects such as rings that will not come off, mark “No” in the screening questions and proceed with the exam. (Inability or refusal to remove jewelry is not exclusion for DXA; however, the SP should be encouraged to remove all metal objects if possible.) False teeth and hearing aids do not have to be removed. If a female SP needs to remove her bra for the scan, pause the exam and escort her to the nearest restroom at this time.

Before moving the table or C-arm:

- Confirm that the runner area of the table is clear of objects that might interfere with table movement; and
- Check that the table scan area is clear of articles that might interfere with table movement.

For some SPs, the table can be adjusted to make it easier for them to get on or off the table. This is optional and may not be needed for all SPs. Press the left arm switch on the Horizon A table Control Panel to allow the C-arm to move to the far left and extend the table out from the base. See Figure 3-2 earlier in this chapter.

- After the C-arm and table stop moving, have the SP lie down on their back with their head to your right as you face the table. Press the “Center” switch on the Control Panel, and wait for the C-arm to position itself to the center of the table.
- Make sure that the SP’s body is entirely within the scan limit borders on the pad, especially the SP’s head (see Figure 3-3.)

Figure 3-3. Scan table pad (top view)

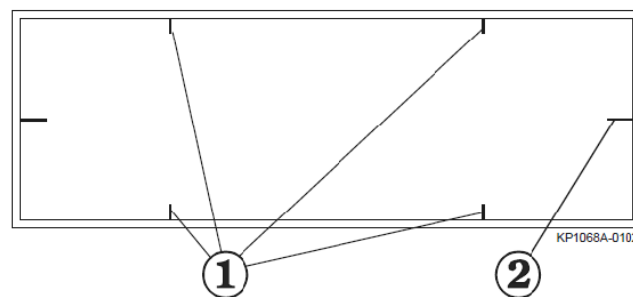

Item	Description	Function
1	Scan Limit border	Indicates the maximum scan range of the unit. Patient positioning must be within this border.
2	Center Lines	Used to center the patient on the table.

3.5 Whole Body DXA Scan

Make sure all Shared Exclusion, Screening, and Safety Exclusion questions in ISIS have been answered and you are up to the Data Capture screen in ISIS before performing a scan. In the Hologic computer, click the “Perform Exam” icon or “Exam” in the top menu bar and select “Perform Exam” from its drop-down menu (Exhibit 3-4).

Exhibit 3-4. Selecting “perform exam”

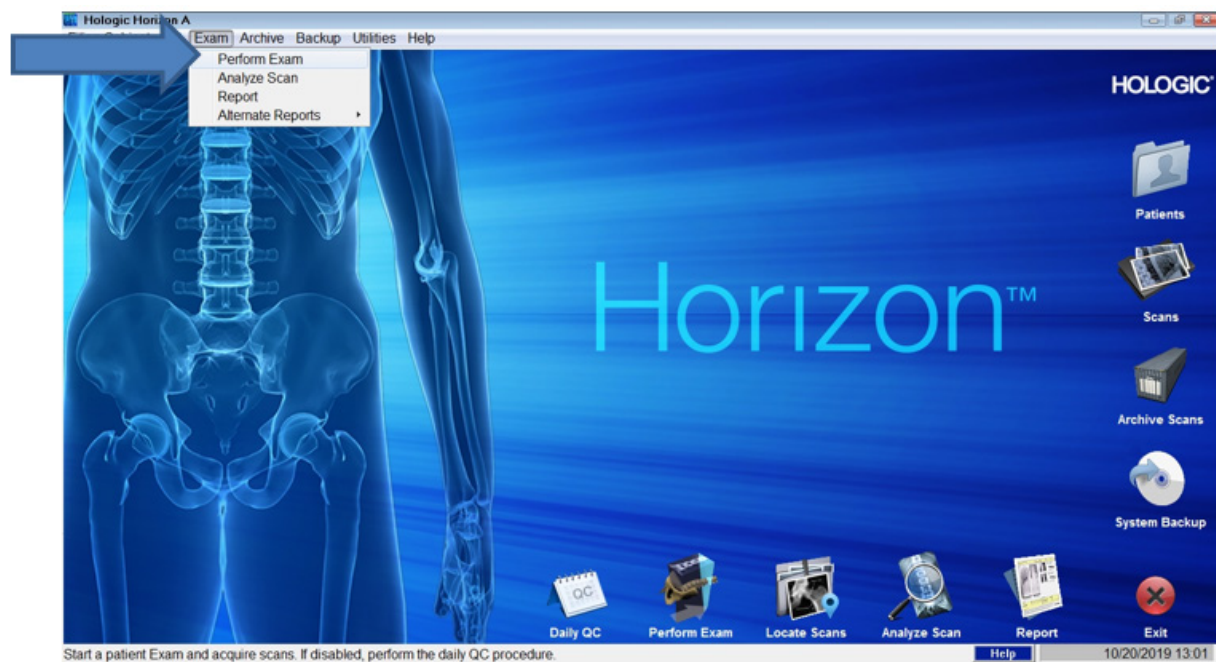

3.5.1 Selecting an SP

In the “Patient Selection” screen, enter the SP ID from the ISIS screen into the blank white field for Patient Name, or highlight the SP ID from the list of IDs under the Patient Name column.

Double-check that you entered the correct SP ID by asking the SP for their date of birth.

Press “OK.” See Exhibit 3-5.

Exhibit 3-5. Patient Selection screen

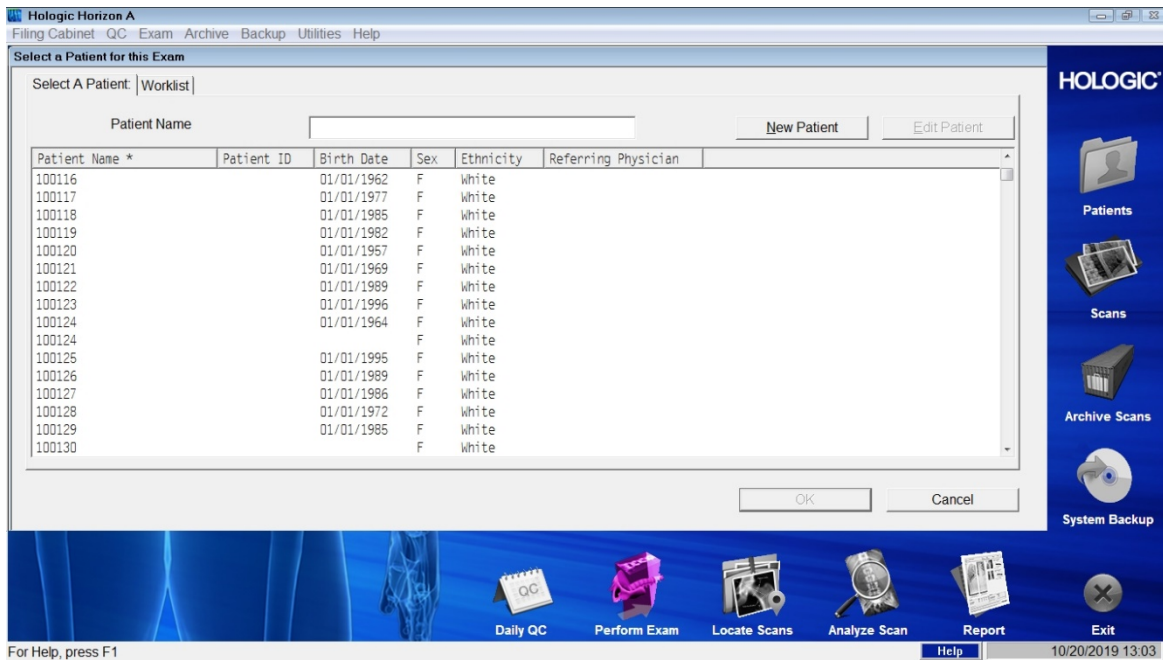

Enter your initials in the “Operator” field and click OK. See Exhibit 3-6.

Exhibit 3-6. Operator field for initials

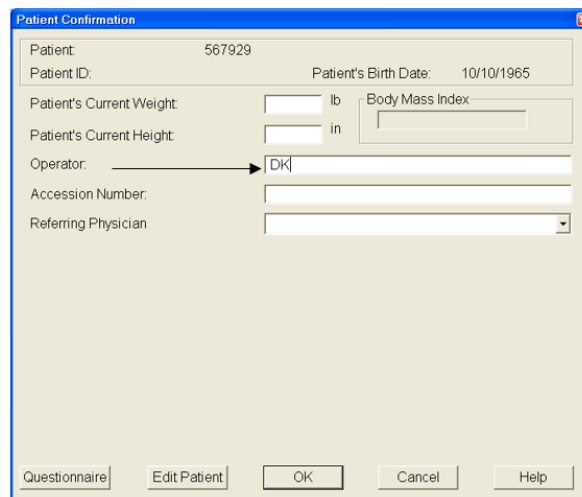

3.5.2 Selecting the Type of Scan

The next screen will display the types of scans to choose from. In the “Scan Selection” screen, select the scan type by clicking on “Whole Body” with the mouse. The scan type is highlighted. See Exhibit 3-7. Click the “Next >>” button. Note that if the SP was selected for the High-Power Whole Body option, you will select HP Whole Body from the Scan Selection screen.

Exhibit 3-7. Scan Selection screen

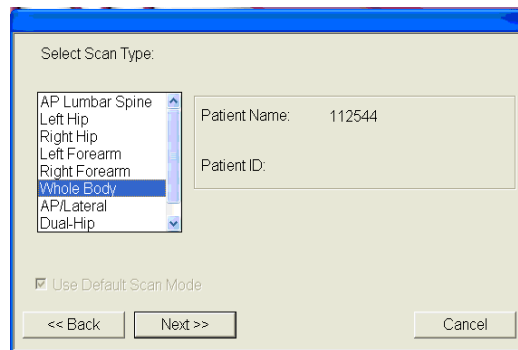

- The Whole Body Scan Parameters screen will display. See Exhibit 3-8 later in this chapter.
- Verify the SP ID under Patient Name and the scan type in the upper left corner. **Stop here** and position the SP for the scan.

3.5.3 Positioning the SP

Check to make sure the SP is in the center of the table with respect to the center lines at the head and foot of the pad. One method to check this is to position yourself at the foot of the table and look at the alignment of the body. Visualize a straight line from the nose, center of the body, and down through the knees and toes.

- Leave at least two finger spaces between the top border line and the SP's head to avoid clipping the head in the scan.
- During the head positioning, the chin should be straight to avoid the neckline being cut through the shoulder bone.
- The SP should lie flat on the table without a pillow. If the SP has trouble lying flat due to back problems or difficulty breathing, use the radiolucent pillow to support the head. The pillow should be covered with the disposable exam paper. If the pillow does not provide sufficient support, use the radiolucent foam block or one of the foam wedges. These may also be used under the knees if the SP has difficulty lying flat.
- If the SP continues to have difficulty lying flat or with the head slightly supported, exclude him or her from the exam.
- Gather the disposable scrub top on top of the belly area for proper hip positioning, and tuck the disposable bottom under the hip area for leg positioning.

- The legs must be positioned together with the feet relaxed and toes pointed upward. Use the Velcro strap around the ankles to support the legs in this position and to prevent any movement. Do not wrap the Velcro strap too tightly, and make sure there is at least half an inch to an inch space between the feet. See Figure 3-4 for proper positioning of the whole body scan.
- Place the SP's arms straight at his or her sides, palms down, with separation from the torso. Verify that the arms are within the scan border. If necessary, with larger SPs the hands may be placed in a lateral position next to the hips to remain within 1" of the scan border. **Do not** tuck the hands under the body. **There must be a space between the SP's arms and sides whenever possible.**
- Remind the SP to breathe normally during the scan and pay attention to the SP while the C-arm is moving. Coach the SP through the scan; for example: "That was the first pass," "You are doing well," or "We're almost done."

Figure 3-4. Correctly positioned whole body scan

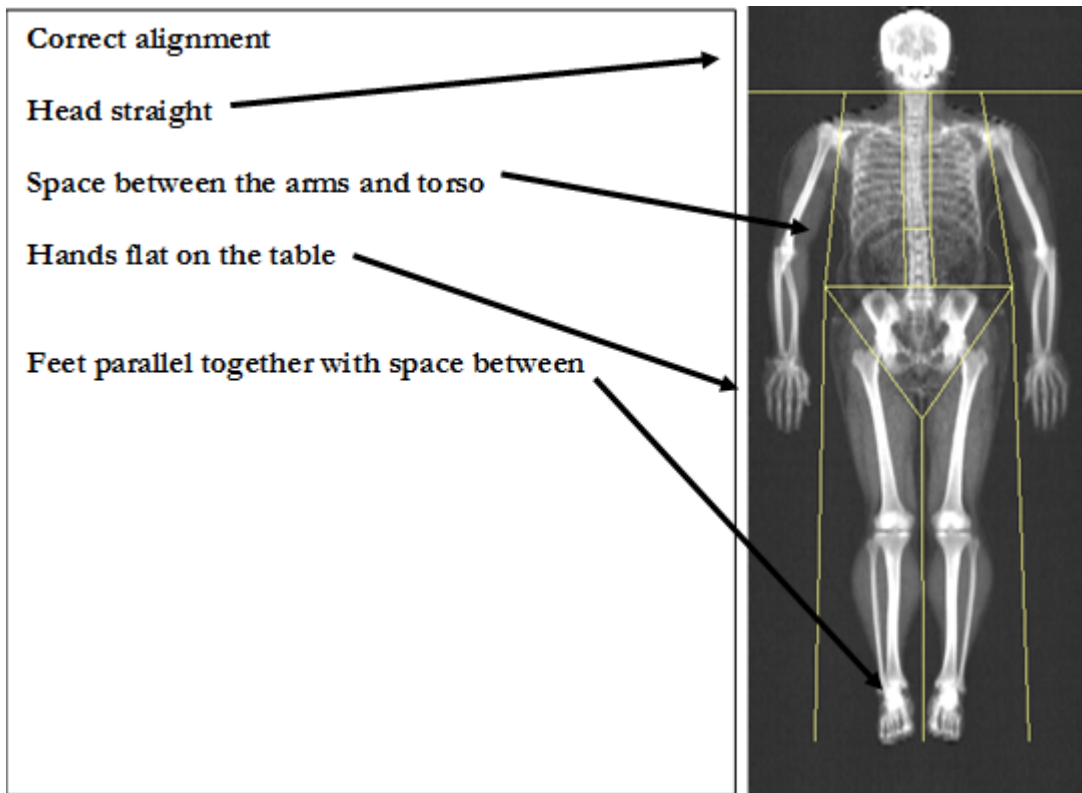

3.5.4 Reflection Positioning

There are several challenges in the scanning and analysis of heavy SPs. Reflection positioning should be used when an SP does not fit within the scan border. A “Reflection” protocol is where the patient is positioned off the center line of the scan table to ensure that one side, typically the right side, is completely included in the scan field. On the resulting image, the pelvis must be totally included. **All SPs ages 18-59 who require reflection positioning should receive a high-power whole body scan if not already identified by their BMI values.**

Positioning:

- Position the subject the same as for a normally centered scan.
- Offset the SP to their left so that the right side is included in the scan area; try to keep the torso within the scan area.
- The right side of the body and the left pelvis area should be at least one inch from the scan border. The entire pelvis, including the bones and soft tissue, must be within the scan border.
- Make sure the spine is straight (parallel to the center lines).
- There should still be separation of the hands and arms with the body.
- With the offsetting, **the left arm has to be out of the scan area up to and including the elbow** for the “Reflection” technique to activate. See Figure 3-5. The right hand should be flat on the table or lateral to the table to allow for separation between the hand and arm and the body (you may have to feel for the separation with some SPs).
- Place the cover over the control panel to prevent the emergency button from getting pushed.
- Scan the SP as usual.
- Be sure to mark Reflection positioning under the scan comments.

Figure 3-5. Reflection positioning

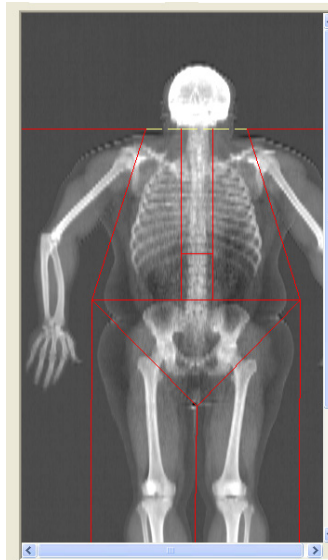
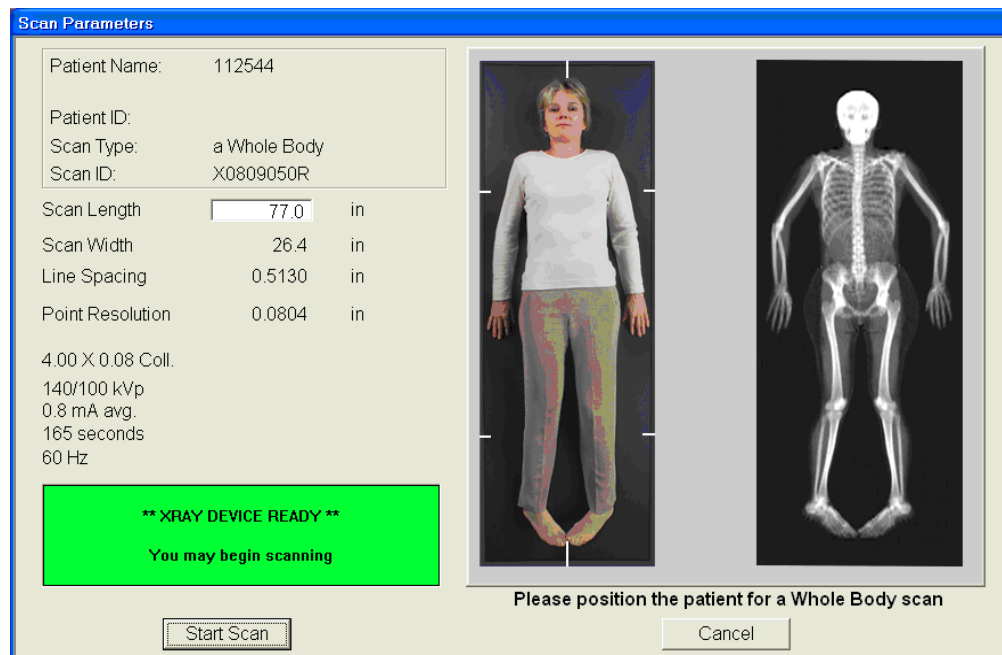

Exhibit 3-8. Whole Body Scan Parameters screen



- After the SP is positioned correctly for the whole body scan, check one more time to ensure there are no objects that will interfere with the movement of the table or the runner belt. Press “Start Scan” to begin the scan.

- The machine will complete the scan.
- **Warning:** If the Control Panel X-ray indicator fails to shut off within 10 seconds after the end of the scan, press the red **Emergency Stop** button immediately. Call the Hologic service representative before resuming operation.

Positioning (Last Resort):

- If an SP is very large and the technician is not able to image both sides of the torso on reflection, use the “last resort” procedure to attempt to obtain as much data as possible.
- Position the SP in the center of the table with both hands at his or her sides (same as for a normally centered scan under Section 3.5.3).
- Check to ensure there are no objects (including SP’s hands) that will interfere with the movement of the table or the runner belt. In this case, the main focus is the trunk; not including hands and arms is acceptable.
- Press “Start Scan” to begin the scan.
- Make sure to document this under the scan comments to be communicated with the QC Reading Center.

3.5.5 Completing the Scan

The Scan window displays with the image appearing on the left side. The flashing “X-rays On” indicator at the top of the window continues until the scan stops. See Exhibit 3-9.

Exhibit 3-9. Whole body scan image

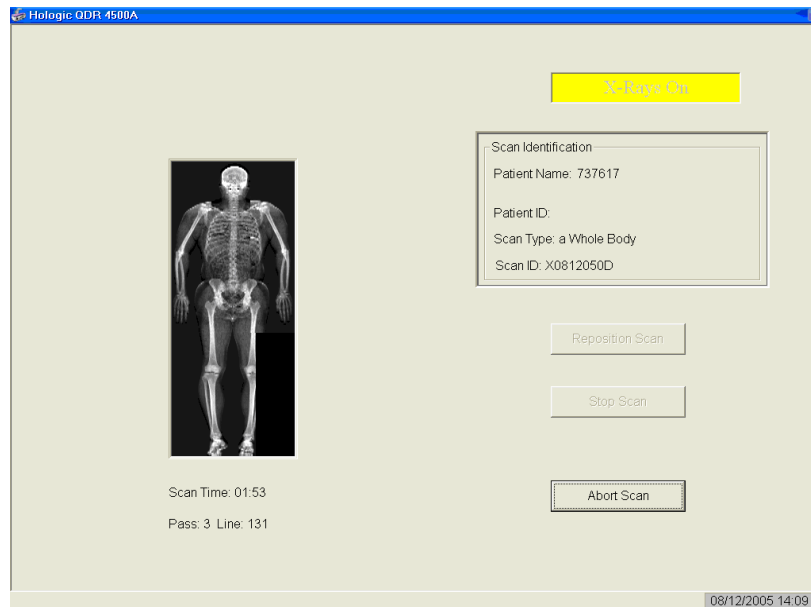

Make sure the SP's arms are included in the scan on the first and last pass of the C-arm. The SP should remain still until the scan is complete. Allow the scan to complete.

- The analysis will be done later by the QC Reading Center.
- Go to the ISIS screen and complete the DXA Data Entry screen.
- Remove the Velcro strap from the SP's ankle and clean it with a Sani-wipe.
- See Chapter 5 for a description of the information provided to the SPs from this test.
- When the exam completes, an Exit/New Scan Window box displays. See Exhibit 3-10. Click on "Exit Exam."

Exhibit 3-10. Exit Exam/New Scan Window box

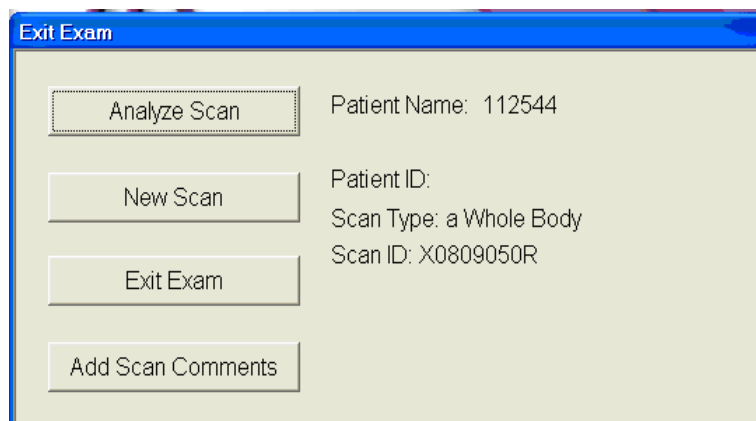

3.5.6 DXA Scan Data

- Analysis of the scan will be done at the QC Reading Center.
- Figure 3-6 shows the data displayed after the regions of interest are selected and the analysis is completed.
- This figure also displays the percentage of fat by region and for the total body. The percentage of total body fat for the hypothetical SP in the example is 23.6 percent.

Figure 3-6. Data displayed after analysis (1)

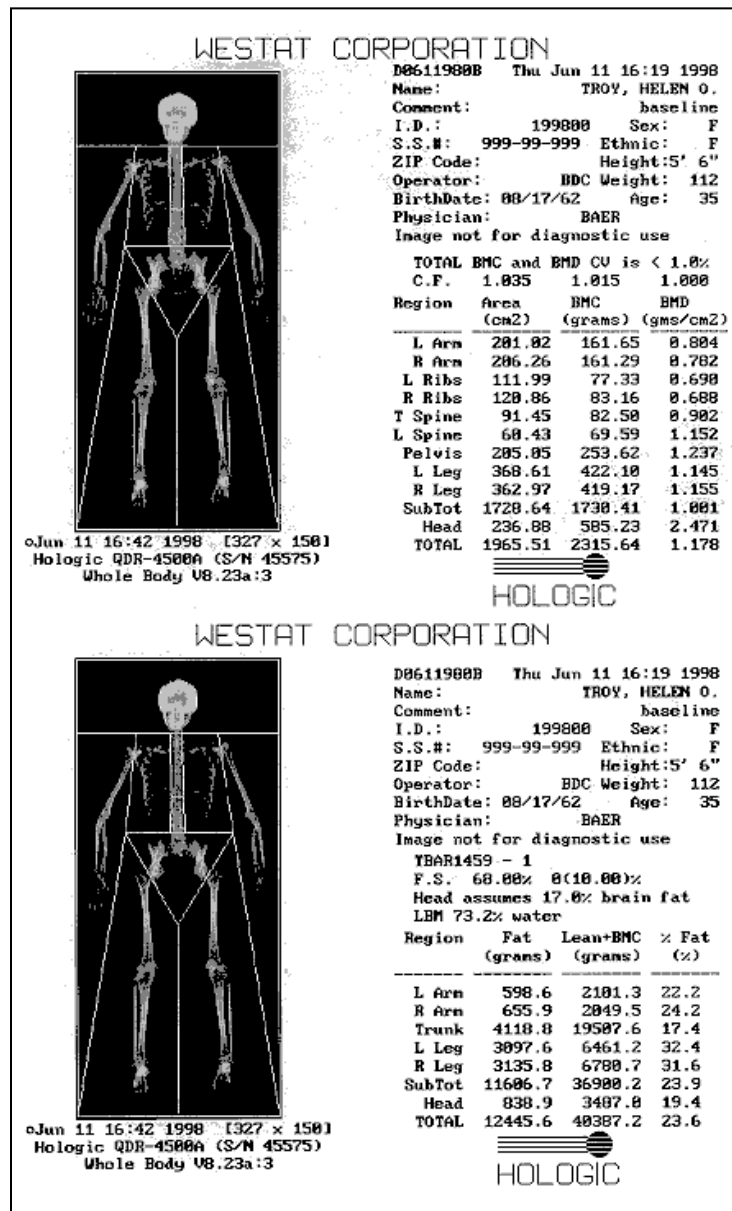

4. Data Entry Screens

4.1 Shared Exclusion Questions

The Shared Exclusion Questions may be answered in several components in the MEC. If these questions have been answered in a previous component in the MEC, the questions and responses will be displayed in read-only format. If the sample person (SP) is excluded from this exam based on their answers to the Shared Exclusion Questions in another component, the SP will be blocked from the body composition by the Coordinator System and will not be sent to this exam. The Component Status for body composition for this SP would be set to “Not Done” with a comment specific to the reason for exclusion (safety exclusion, physical limitation, etc.).

Note: Not all of the Shared Exclusion Questions will exclude the SP from the DXA component. If you get a “Yes” response to certain Shared Exclusion Questions, the SP will not be excluded immediately. You must ask the remaining Shared Exclusion Questions and press the Next button before the SP is excluded. Other components will use the responses to these questions to determine eligibility. See Exhibit 4-1 for the Shared Exclusion Questions.

Exhibit 4-1. Shared exclusion questions

The screenshot shows a software window titled "Body Composition Exam Subsystem: Stand615 Session615271 09/22/2010 01:30 pm - 05:30 pm". Below the title bar, there is a menu bar (File, View, Utilities, Reports, Window, Help) and a toolbar. The main content area is titled "DXA: Stand615 Session615271 09/22/2010 01:30 pm - 05:30 pm" and displays patient information: "SP ID: 908844 Name: TRUELOVE 1, ANN Age: 36 years Gender: Female Date: 04/19/2011 Time: 02:50 PM". Below this, the section "Shared Exclusion Questions" contains five questions, each with a dropdown menu:

- Do you have a pacemaker or automatic defibrillator?
- Are you currently pregnant?
- In the past 7 days have you had any x-rays or scans that used contrast material such as dyes or barium?
- Do you have any amputations of your legs and feet other than toes?
- Where is the amputation?

At the bottom of the screen, there is a navigation bar with buttons for "End of Section", "Close Exam", and "Finish", along with a "1 of 5" indicator and a blue arrow icon. The Windows taskbar at the very bottom shows the system tray with the time "2:50 PM" and the taskbar icon for "Body Composition Ex..."

Do you have a pacemaker or automatic defibrillator?

SPs are not excluded from DXA due to a pacemaker or automatic defibrillator.

Are you currently pregnant?

- If the response to the question “Are you currently pregnant?” is “Yes” or “Don’t Know,” the SP will be excluded from DXA due to pregnancy status.
- When the Next button is pressed, a message will be displayed: “Excluded from DXA due to pregnancy status.” See Exhibit 4-2. Press OK to this message.

Exhibit 4-2. Exclusion from DXA due to pregnancy status

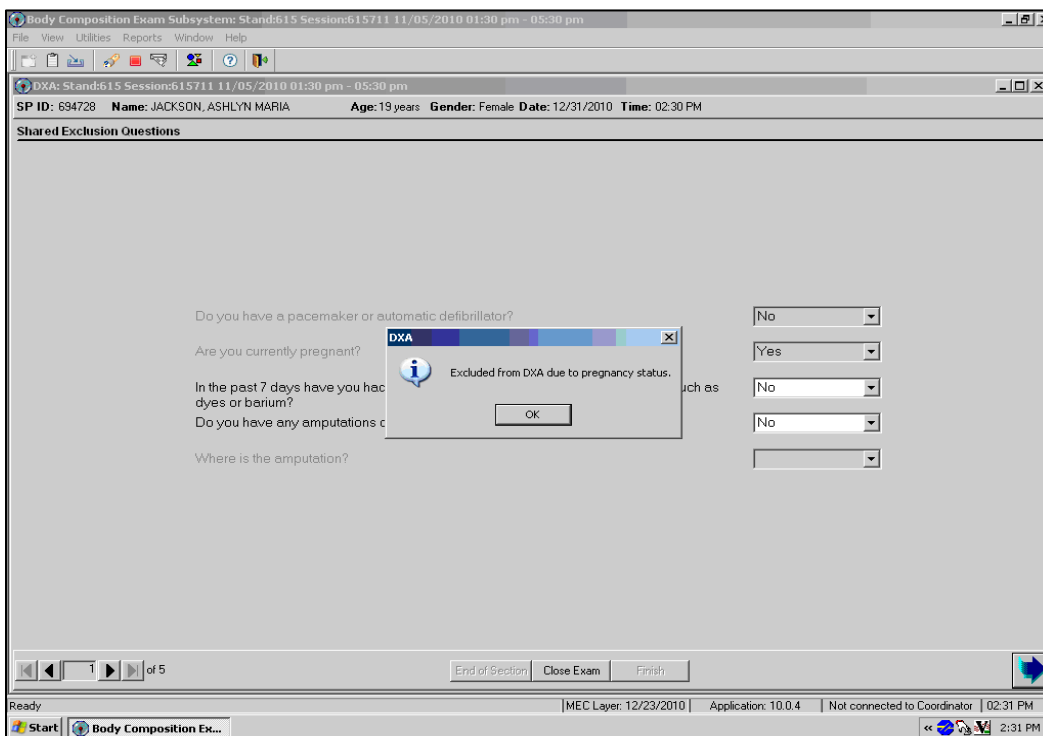

The Component Status will be set to “Not done” with the comment “SP pregnant.” If the SP is a male or a female age 8-15 years, the pregnancy question will not be displayed. See Exhibit 4-3. (The question on self-reported pregnancy status for 12- to 15-year-old females will be asked in the clinician’s exam or in phlebotomy.)

Exhibit 4-3. Shared exclusion questions without pregnancy question

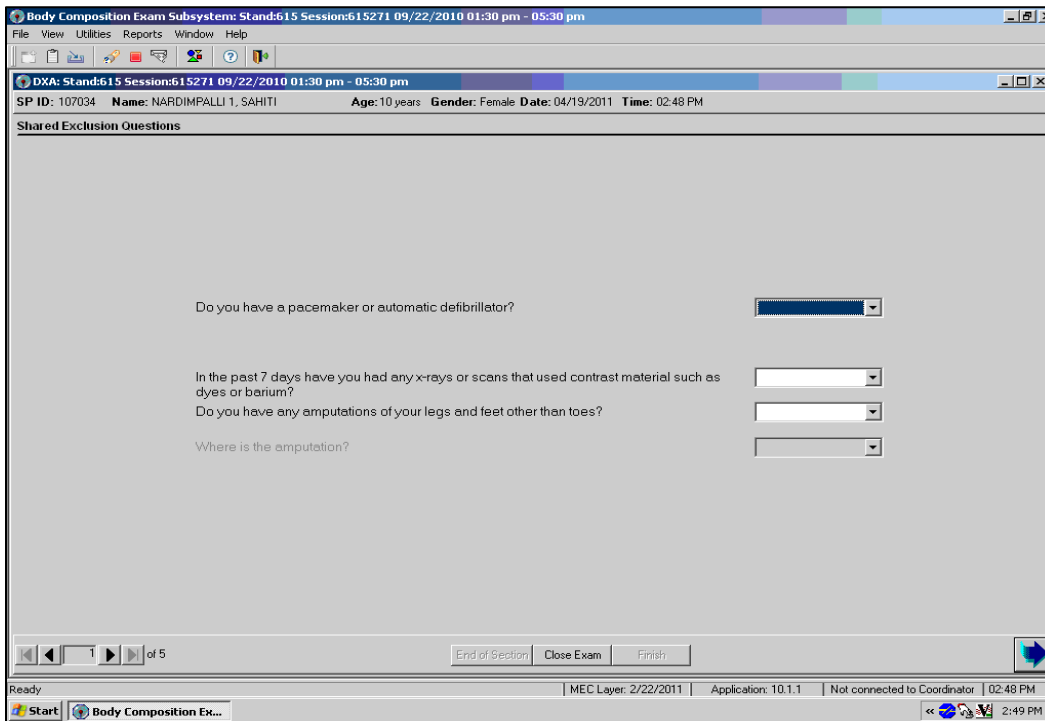

In the past 7 days, have you had any X-rays or scans that used contrast material such as dyes or barium?

If the response to the question “In the past 7 days have you had any X-rays or scans that used contrast material such as dyes or barium?” is “No,” continue with the next question.

- If the response to the question is “Yes,” the SP will be excluded from DXA.
- Complete the remainder of the questions. When the Next button is pressed, a message will be displayed: “Excluded from DXA due to data effect.” See Exhibit 4-4. Click OK to this message.

Exhibit 4-4. Exclusion from DXA due to data effect

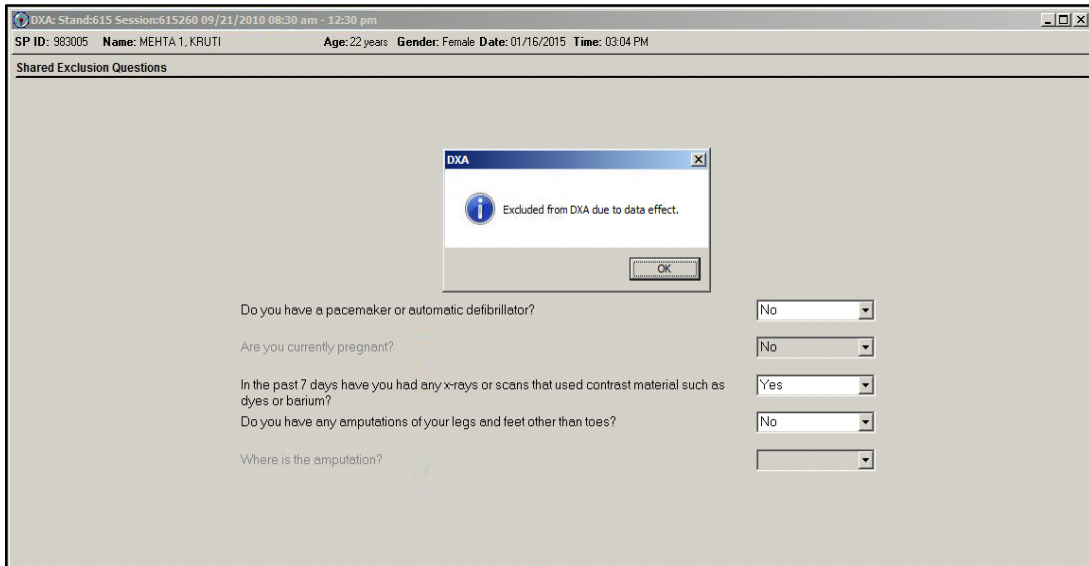

The DXA Component Status will be set to “Not Done” with the comment “data effect.” See Exhibit 4-5.

Exhibit 4-5. Exam status “not done” due to data effect

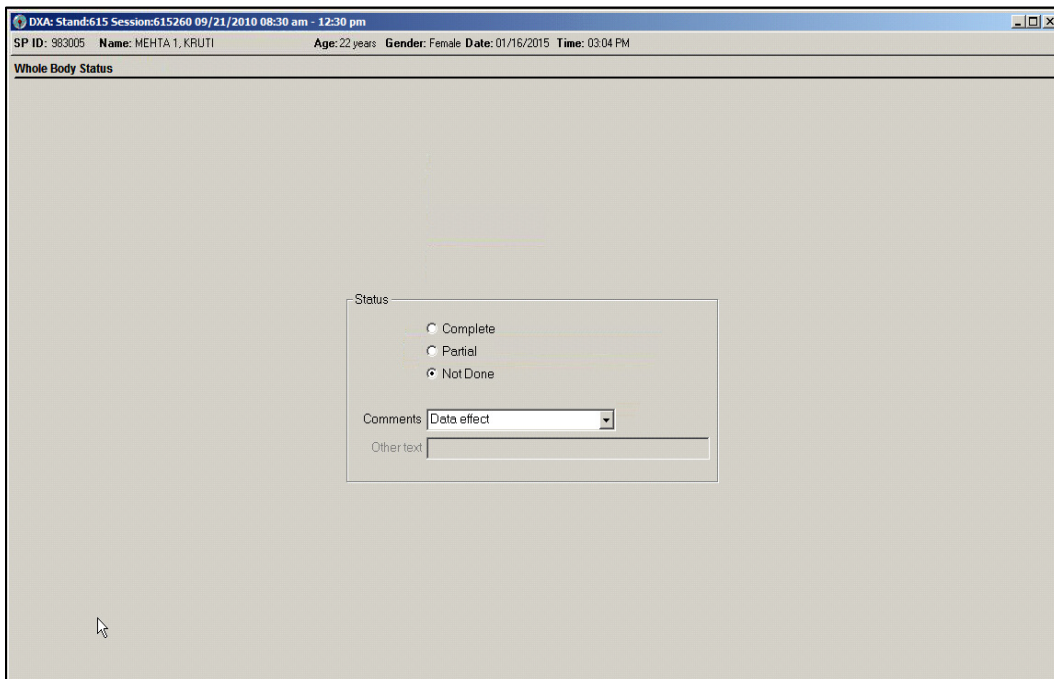

Do you have any amputations other than fingers and toes?

- SPs are not excluded from the DXA exam based on an amputation. If the answer to “Do you have any amputations other than fingers and toes?” is “No,” the SP remains eligible for the exam.
- If the response is “Yes,” the question “Where is the amputation?” will be highlighted with response options of Right, Left, or Both. See Exhibit 4-6.

Exhibit 4-6. Response options for question “Where is the amputation?”

The screenshot displays the 'Body Composition Exam Subsystem' interface. At the top, it shows the session information: 'DXA: Stand:615 Session:615512 10/16/2010 05:30 pm - 09:30 pm'. Below this, patient information is listed: 'SP ID: 874754 Name: WANG, MARY D Age: 53 years Gender: Female Date: 12/31/2010 Time: 02:18 PM'. The main section is titled 'Shared Exclusion Questions' and contains five questions with corresponding dropdown menus:

- Do you have a pacemaker or automatic defibrillator? (Yes)
- Are you currently pregnant? (No)
- In the past 7 days have you had any x-rays or scans that used contrast material such as dyes or barium? (No)
- Do you have any amputations of your legs and feet other than toes? (Yes)
- Where is the amputation? (Right, Left, Both)

The 'Where is the amputation?' question is highlighted, and its dropdown menu is open, showing the options: Right, Left, and Both. At the bottom of the window, there are navigation buttons: 'End of Section', 'Close Exam', and 'Finish'. The system tray at the bottom shows the time as 2:19 PM.

- When all Shared Exclusion Questions are answered, the system will display a series of messages regarding the exclusions to other components based on the question.
- If there are no exclusions based on the Shared Exclusion Questions, press the Next button. The system will advance to the Weight/Height Entry screen.

4.2 Weight/Height Entry Screen

After answering the Shared Exclusion Questions, the next screen displayed will be the Weight/Height Entry screen. See Exhibit 4-7. Due to limitations of the DXA table, SPs may be excluded from DXA due to their height and/or weight. If the SP was in the anthropometry (body measures) component prior to this test, the weight and height will already be uploaded and displayed on the ISIS screen, along with the component it transferred from (i.e., Anthropometry). This information will be grayed out. See Exhibit 4-8. If the information is not displayed, you will need to measure the SP's weight and height using the floor scale and stadiometer in the room. Enter these numbers into the white entry fields next to "Weight" and "Height." See Exhibit 4-9. For instructions on measuring weight and height, see Section 3.4.1.

Note: If the SP's weight is more than 450 lbs., or their height is greater than 6'5", the SP will be excluded from the exam.

Exhibit 4-7. Weight/Height Entry screen

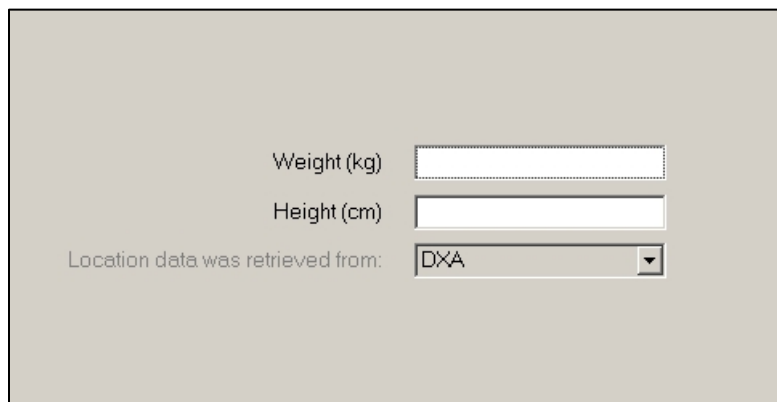

Weight (kg)

Height (cm)

Location data was retrieved from:

Exhibit 4-8. Weight/height information transferred from body measures

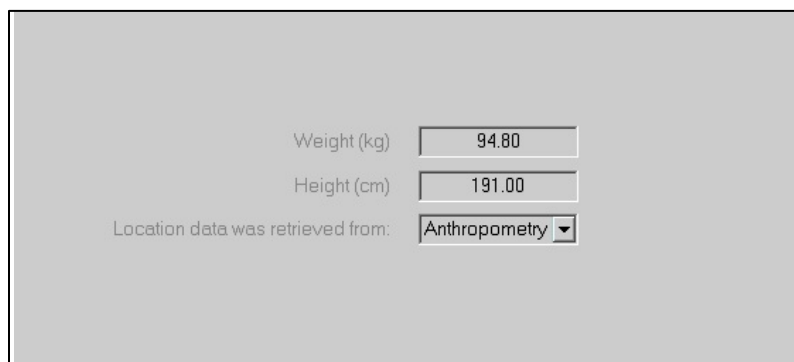

Weight (kg)

Height (cm)

Location data was retrieved from:

Exhibit 4-9. Entering the weight/height information into the screen

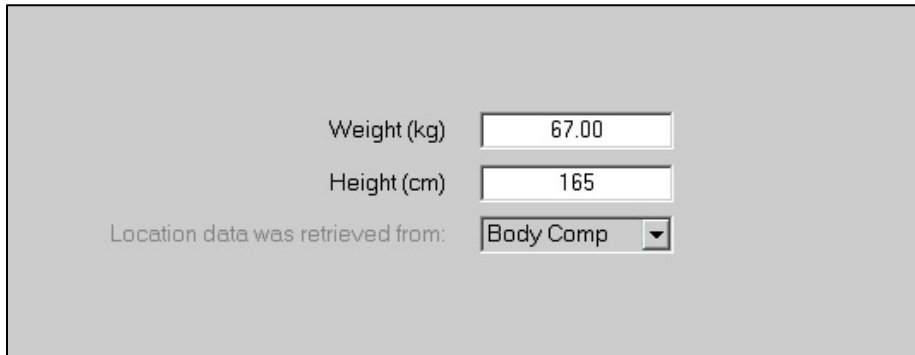

A screenshot of a software interface with a light gray background. It contains three input fields: "Weight (kg)" with the value "67.00", "Height (cm)" with the value "165", and a dropdown menu labeled "Location data was retrieved from:" with "Body Comp" selected. The dropdown arrow points downwards.

The system will use the height and weight measurements to calculate the body mass index (BMI), which will determine whether the SP needs the high-power whole body scan or not. Females with a BMI ≥ 32 and males with a BMI ≥ 31 will be selected for this option if they are 18 years or older. If the SP has been selected for the high-power whole body scan, a message will display on the screen (see Exhibit 4-10) and again in Whole Body Data Capture screen, notifying the tech to select this option when performing the scan. See Section 4.4, Exhibit 4-18. SPs selected for the high-power option may also be excluded if there is less than 6 inches of clearance between the SP and the C-arm.

Exhibit 4-10. Selection for high-power scan

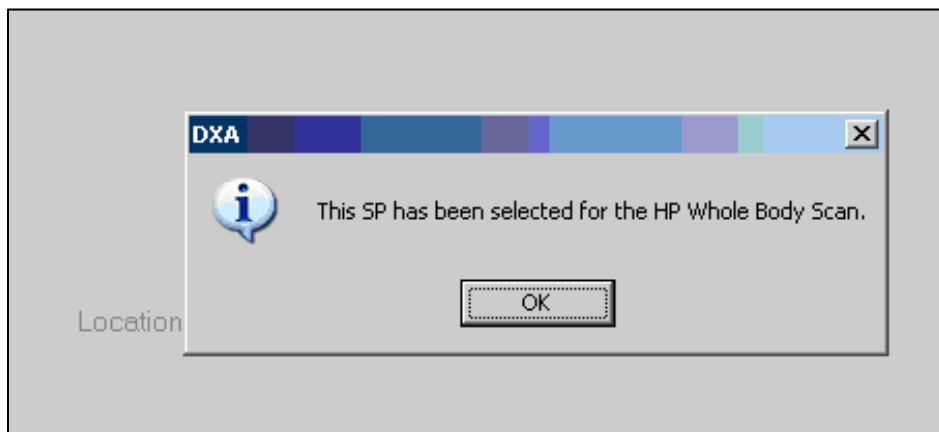

4.3 Screening and Safety Questions

The screening and safety questions should be read exactly as written. Read the entire question before accepting an answer. If the SP interrupts you before you have completed reading the question, say that you are required to read the entire question before accepting an answer. See Exhibit 4-11.

Exhibit 4-11. Screening questions

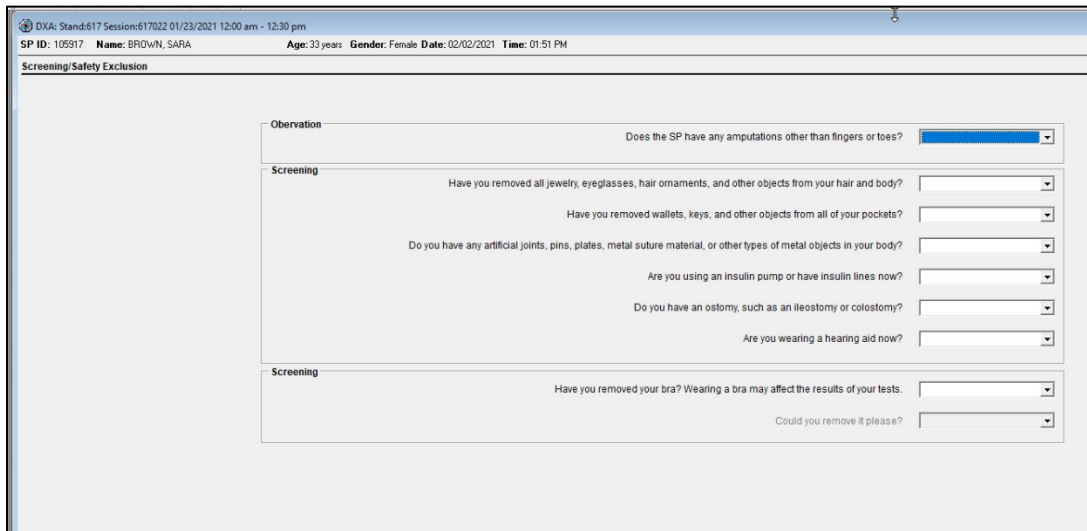

The screenshot shows a software window titled "DXA: Stand:617 Session:617022 01/23/2021 12:00 am - 12:30 pm". Below the title bar, patient information is displayed: "SP ID: 105917 Name: BROWN, SARA Age: 33 years Gender: Female Date: 02/02/2021 Time: 01:51 PM". The main content area is titled "Screening/Safety Exclusion" and contains three sections of questions, each with a dropdown menu for the answer:

- Observation:** "Does the SP have any amputations other than fingers or toes?"
- Screening:** A group of five questions:
 - "Have you removed all jewelry, eyeglasses, hair ornaments, and other objects from your hair and body?"
 - "Have you removed wallets, keys, and other objects from all of your pockets?"
 - "Do you have any artificial joints, pins, plates, metal suture material, or other types of metal objects in your body?"
 - "Are you using an insulin pump or have insulin lines now?"
 - "Do you have an ostomy, such as an ileostomy or colostomy?"
- Screening:** A group of two questions:
 - "Have you removed your bra? Wearing a bra may affect the results of your tests."
 - "Could you remove it please?"

Observation question:

“Does the SP have any amputations other than fingers and toes?”

The first question on the screen is an observation question for the technologist and is not to be asked of the SP. It is not a safety exclusion; therefore, answering “Yes” will not exclude the SP from any DXA exams, but it may affect the analysis of the scans.

Screening questions:

- Have you removed all jewelry, eyeglasses, hair ornaments, and other objects from your hair and body?
- Have you removed wallets, keys, and other objects from all of your pockets?
- Do you have any artificial joints, pins, plates, metal suture material, or other types of metal objects in your body?
- Are you using an insulin pump or have insulin lines now?

- Do you have an ostomy, such as an ileostomy or colostomy?
- Are you wearing a hearing aid now?
- Have you removed your bra? Wearing a bra may affect the results of your tests. (Asked of females only.)
- If the SP answers “No,” the question “Could you remove it please?” will be highlighted with options of “SP removed bra,” or “SP refused to remove bra” (see Exhibit 4-12). If the SP needs to remove her bra, pause the exam and escort her to the nearest restroom after all the questions have been answered.

Note: SP will not be excluded from any exams if her bra has not been removed.

Exhibit 4-12. Screening question highlighted with options

The screenshot shows a software window titled "DXA: Stand:615 Session:615260 09/21/2010 08:30 am - 12:30 pm". The patient information at the top includes "SP ID: 918631", "Name: MEHTA 4, KRUTI", "Age: 22 years", "Gender: Female", "Date: 01/16/2015", and "Time: 03:11 PM". The main section is titled "Screening/Safety Exclusion".

Under the "Observation" section, there is a question: "Does the SP have any amputations other than fingers or toes?" with a dropdown menu set to "Yes".

Under the "Screening" section, there are five questions, each with a dropdown menu:

- "Have you removed all jewelry, eyeglasses, hair ornaments, and other objects from your hair and body?" (Yes)
- "Have you removed wallets, keys, and other objects from all of your pockets?" (Yes)
- "Do you have any artificial joints, pins, plates, metal suture material, or other types of metal objects in your body?" (No)
- "Are you using an insulin pump or have insulin lines now?" (No)
- "Do you have an ostomy, such as an ileostomy or colostomy?" (No)
- "Are you wearing a hearing aid now?" (No)

Below these, another "Screening" section contains two questions:

- "Have you removed your bra? Wearing a bra may affect the results of your tests." (No)
- "Could you remove it please?" (This question is highlighted in yellow, and its dropdown menu is open, showing two options: "SP removed bra" and "SP refused to remove bra".)

4.4 DXA Whole Body Data Capture Screen

Exhibit 4-13 is the ISIS Whole Body Data Capture screen. This screen allows you to check whether the scan was completed after answering the reflection positioning question.

Exhibit 4-13. Whole body data capture (1)

Body Composition Exam Subsystem: Stand615 Session:615810 11/15/2010 08:30 am - 12:30 pm

DXA: Stand615 Session:615810 11/15/2010 08:30 am - 12:30 pm

SP ID: 745052 Name: EVANS, SAVANNAH M Age: 41 years Gender: Female Date: 12/10/2012 Time: 02:03 PM

DXA Data Capture

Whole Body Scan

Is reflection positioning required? Yes No

Scan completed: Yes No

Comment on scan: Check all that apply:

- SP movement during exam
- Positioning problem
- Jewelry or other objects not removed
- Hands positioned along sides, not flat
- Pillow used for head support
- Too tall for table, feet out of scan
- Equipment failure
- Reflection used during the whole body scan
- Less than 6 inches of clearance

Other:

Archive File name:

BMI: 23

End of Section Close Exam Finish

Ready MEC Layer: 9/12/2012 Application: 10.2.2 Not connected to Coordinator 02:05 PM

If reflection positioning is required, a message will appear to select the high-power option. See Exhibit 4-14.

Exhibit 4-14. Whole body data capture with reflection positioning

Whole Body Scan

Is reflection positioning required? Yes No

Scan completed: Yes No

Comment on scan Check all that apply:

SP movement during exam

Equipment failure

Reflection used during the whole body scan

Less than 6 inches of clearance

Other:

DXA

Please select the HP Whole Body Scan.

OK

Click OK and complete the scan. The screen has checkboxes to record any problems in getting a good quality scan. You can check one or more of the following problems:

- SP movement during the exam;
- Positioning problem;
- Jewelry or other objects not removed;
- Hands positioned along sides, not flat;
- Pillow used for head support;
- Too tall for table, feet out of scan;
- Equipment failure;
- Reflection used during the whole body scan;
- Less than 6 inches of clearance (enabled for SPs selected for high-power option); or
- Other (specify).

If the scan has been completed, select “Yes.” See Exhibit 4-15.

Exhibit 4-15. DXA data capture (2)

Whole Body Scan

Is reflection positioning required? Yes No

Scan completed: Yes No

Comment on scan Check all that apply:

- SP movement during exam
- Positioning problem
- Jewelry or other objects not removed
- Hands positioned along sides, not flat
- Pillow used for head support
- Too tall for table, feet cut out of scan
- Equipment failure
- Reflection used during the whole body scan
- Less than 6 inches of clearance

Other:

Archive File name: D12101200.ARC

BMI: 23

The system will automatically enter the Archive Filename. The Archive number is D for DXA, 121012 for December 10, 2012, and 00 for the first file to be archived. The file extension is .ARC.

During and immediately after the scan, check the scan for quality. See Exhibit 4-16. Check all comments that apply.

Exhibit 4-16. DXA data capture (comments on scan)

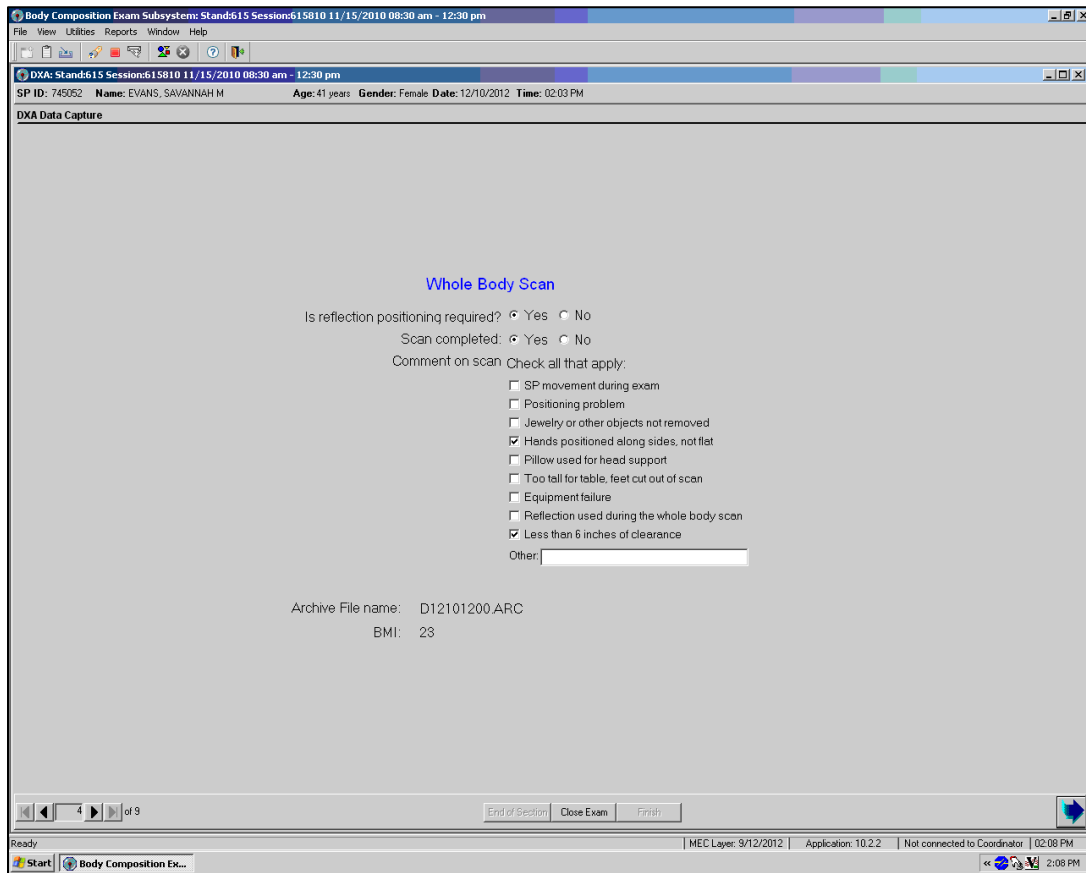

If the DXA scan cannot be completed, select “No.” See Exhibit 4-21 (DXA Component Status). If the reason is equipment failure, check that comment. If there is another reason, enter the reason in the free text box for “Other.”

If the scan cannot be completed, the DXA component status will be set to “Not Done.” Select the appropriate comment from the list in the drop-down menu. See Exhibit 4-17.

Exhibit 4-17. DXA data capture (scan not completed)

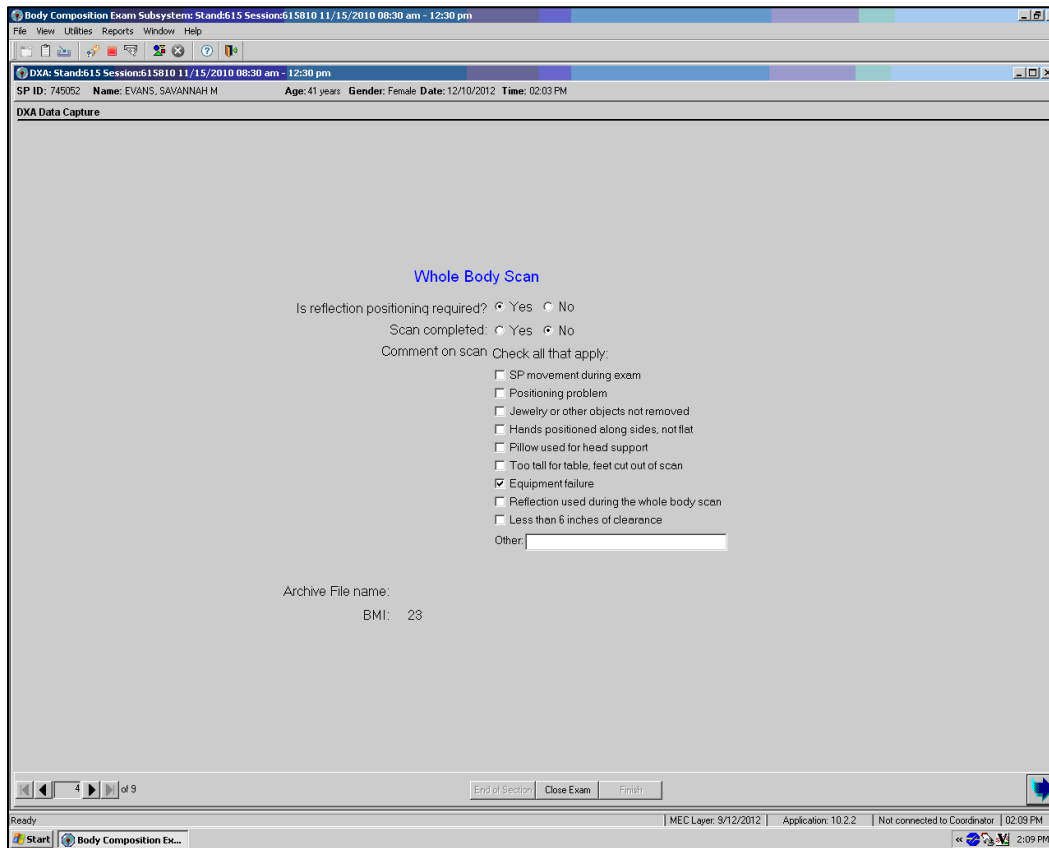

If the SP has been selected for the high-power whole body scan, a message will display in the Whole Body Data Capture screen. See Exhibit 4-18.

Exhibit 4-18. Whole Body Data Capture screen

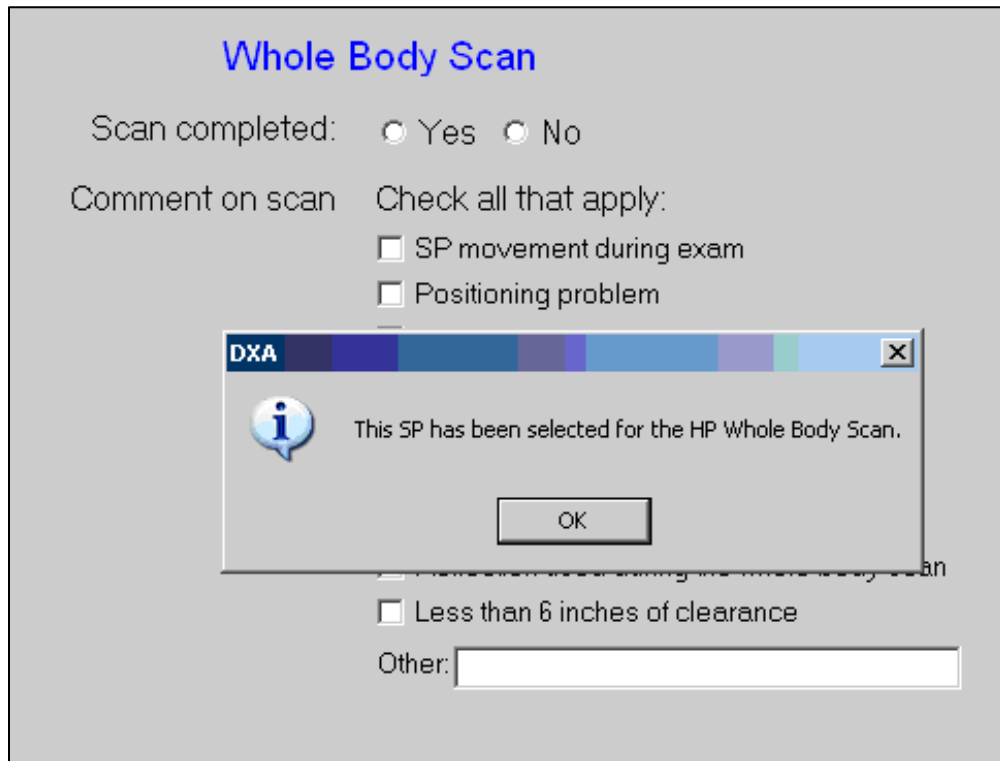

If the SP has been selected for the HP whole body scan and the HP option was not used, an error message will display. See Exhibit 4-19.

Exhibit 4-19. HP error message

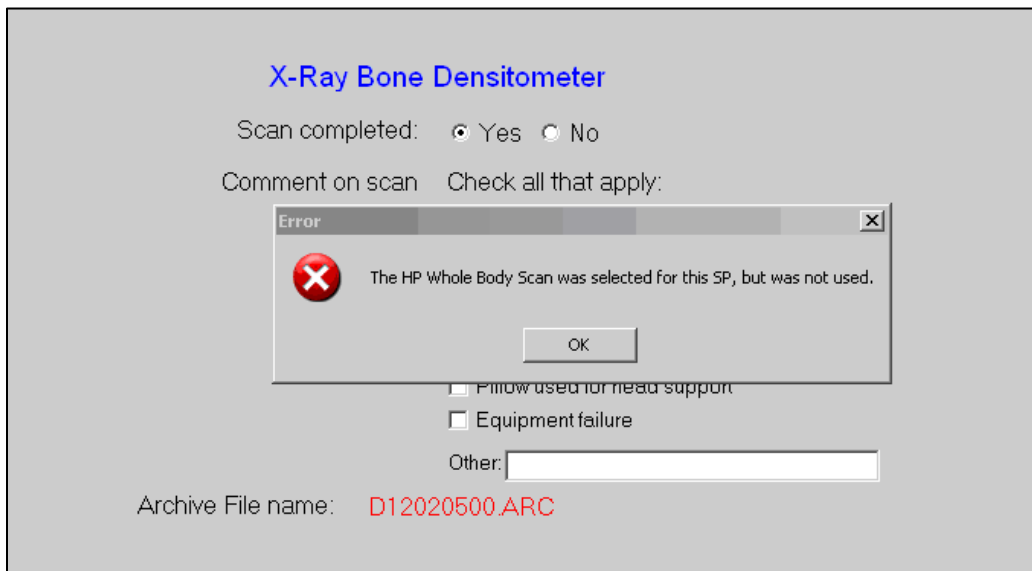

4.5 DXA Component Status

The completion status for the DXA component is any of the following:

- **Complete** Ages 8–59 years Whole body scan completed
- **Partial** Ages 8–59 years Shared and safety exclusion status completed, but whole body scan interrupted or not completed
- **Not Done** Ages 8–59 years Shared and safety exclusion questions not completed, and whole body not completed

If a comment is not selected when the status is “Partial” or “Not Done,” a message will be displayed: “Please select comments.” See Exhibit 4-20.

Exhibit 4-20. DXA component status (required comments)

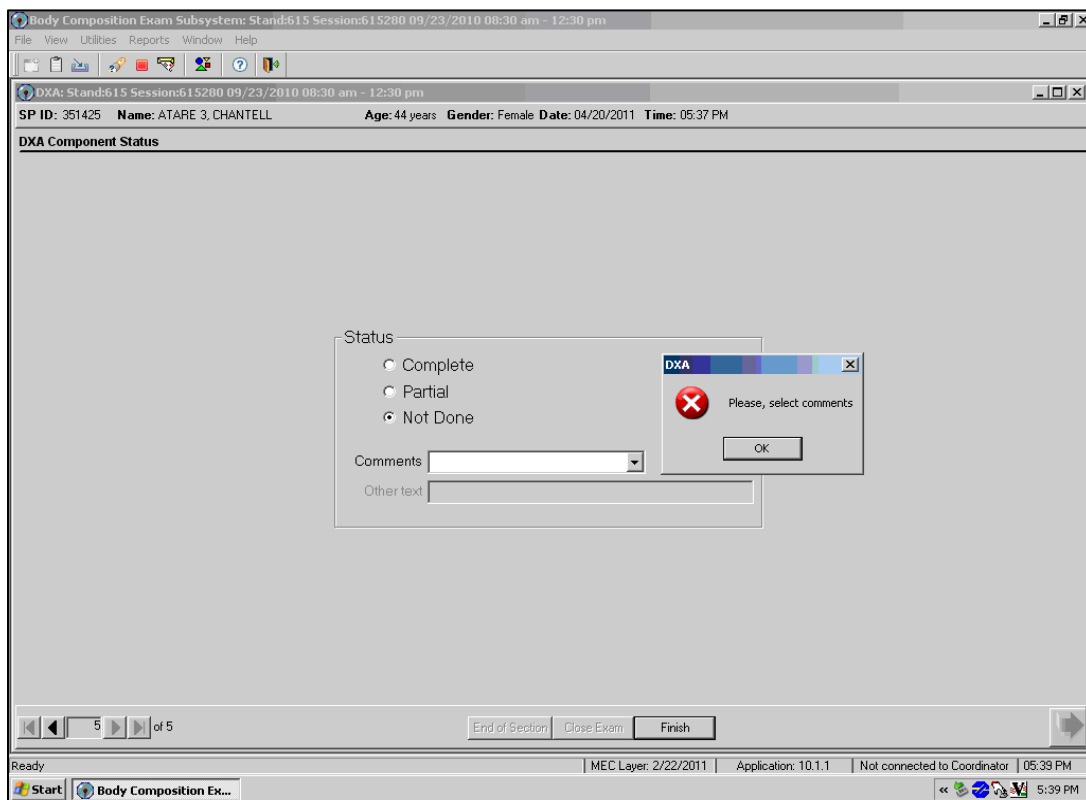

Click OK to this message and select the appropriate comment. Press the Finish button to end the exam.

If the component status is “Partial” or “Not Done,” the system will require a comment to be selected from the drop-down menu. See Exhibit 4-21.

Exhibit 4-21. DXA component status

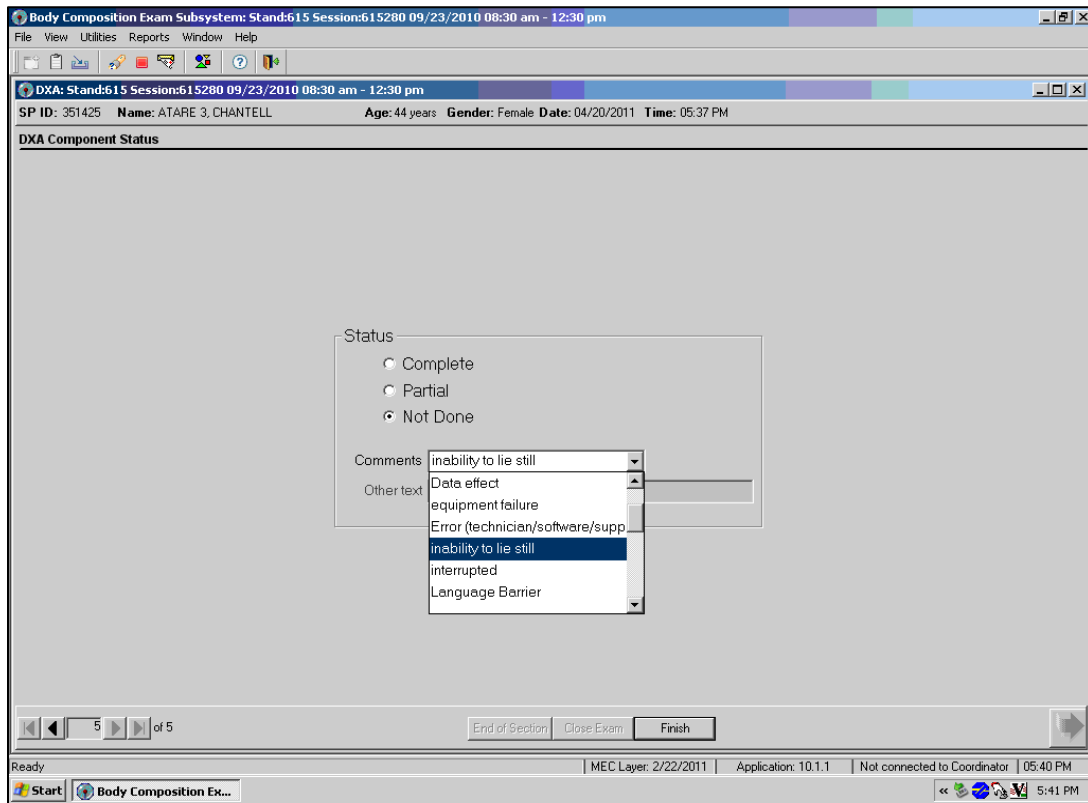

The comments in the drop-down box are the following:

- Data effect;
- Equipment failure;
- Error (technician/software/supplies);
- Inability to lie still;
- Interrupted; and
- Language barrier.

Other comments in the drop-down box that are not shown in Exhibit 4-21 are the following:

- Awaiting pregnancy result;
- Communication problem;
- No time;
- Other (specify);

- Pain or discomfort;
- Physical limitation;
- Proxy, no information;
- Safety exclusion;
- SP did not change clothes;
- SP ill/emergency;
- SP moved during the procedure;
- SP pregnant;
- SP refusal;
- SP unable to comply;
- Urine not collected;
- Weight limitation on equipment; and
- Exceeds height limitation.

4.6 Session Pickup List

- The Session Pickup List box can be accessed from the Toolbar under Reports.
- Go to Reports and select Session Pickup from the menu.
- A list of current sessions will be displayed. See Exhibit 4-22.

Exhibit 4-22. Session pickup list

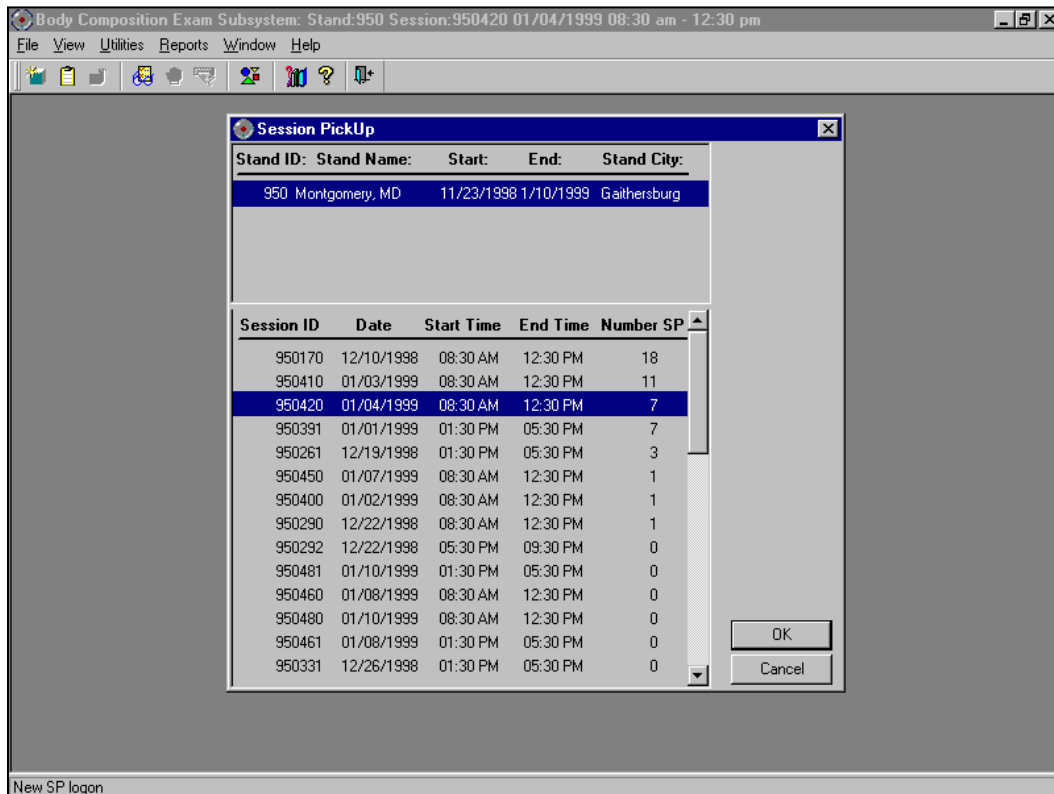

4.7 Session Preview Report

- The Session Preview Report can be accessed from the Toolbar under Reports.
- Go to Reports and select Session Preview from the menu.
- The list of SPs in the current session is displayed. The SP identification number, the type (primary, guest, replicate), name, age, gender, special considerations, and comments are displayed (see Exhibit 4-23).

Exhibit 4-23. Session preview report

SP ID	SP Type	SP Name	Age	Gender	Special Considerations	Consent Comments
256998	Primary	Cynthia Driver	28 years	Female		
860557	Primary	Joan Hemming	55 years	Female		
427820	Primary	Perry Parker	44 years	Male		
177687	Primary	Jack Ruby	44 years	Male		
572165	Primary	Kevin Singleton	33 years	Male		
971761	Primary	Shiela White	38 years	Female		
238554	Primary	Mike Young	18 years	Male		

Page 1 of 1

4.8 Room Log

- The Room Log can be accessed from the Toolbar under Reports.
- Go to Reports and select Room Log from the menu.
- A list of the SPs eligible for this component is displayed.
- The SP ID, name, sex, age, SP status, and component status are displayed. See Exhibit 4-24.

Exhibit 4-24. Room log for body composition

SP ID	SP Name	Gender	Age	SP Status	Component Status
895839	Robin Smith	Male	16		
179292	Charles Kennedy	Male	70		
383612	Patricia Davis	Female	70		
286748	Larry Davis	Male	75		
395452	Mary Matthews	Male	75		
767202	Bob Matthews	Male	72		
211957	Kate Kennedy	Female	28	3	required
140261	Mark Urgo	Male	12	3	complete
932431	Rita Rodgers	Female	29	3	complete
266994	Walter Rodgers	Male	70	3	complete
460247	Clare Urgo	Female	32		not done
668791	Jessica Jackson-smith	Female	33		not done
358087	John Jackson	Male	73		not done
362728	Rosamund Smith	Female	19	3	not done

Page 1 of 1

4.9 Close Exam

Any exam may be terminated at any point during the exam (SP becomes ill, changes their mind about completing the test). See Exhibit 4-25. The “Close Exam” button is used to end the exam abruptly without going through the remaining screens. Choose a comment and click on “Close” to end the exam.

Exhibit 4-25. Close exam

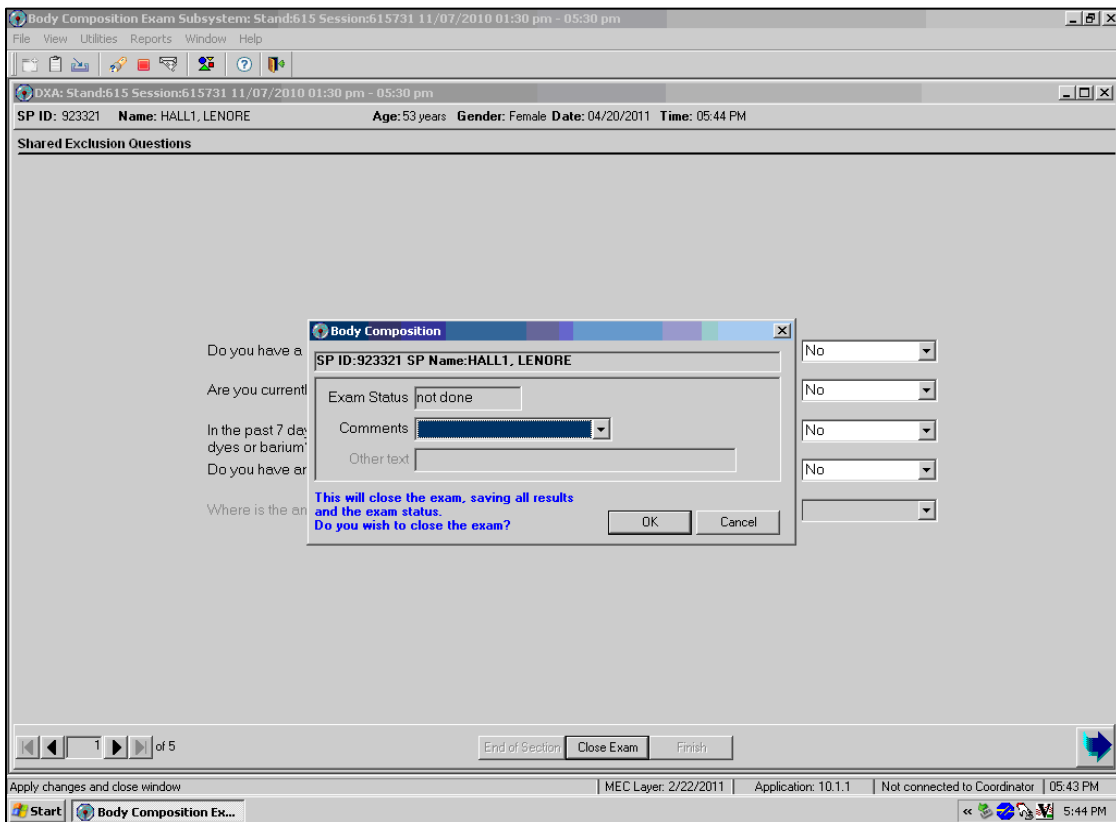

5. Referrals and Report of Findings

5.1 Observation Referrals

Observation referrals are nonemergency situations that may arise in any of the examination rooms in the MEC. Technologists may send an observation referral to the MEC clinician if they notice any condition that may be abnormal or that may warrant further assessment. This type of referral may be sent at any time from any of the exam rooms. The referral may or may not have anything to do with the current exam being performed.

Once a technologist sends a referral to the clinician, the ISIS system will flag the referral for the SP in the Clinician Referral Review box. The SP will not be checked out of the MEC until the clinician has reviewed this referral. The clinician will make a decision whether further action is warranted and whether a clinician referral to the SP's health care provider should be given to the SP.

- Observation referrals can be sent during the exam or after the exam has been closed;
- Under Utilities, select “Observations” (Exhibit 5-1). If an exam is already opened, the Observation Referral box for that SP will be displayed.

Exhibit 5-1. Menu to select observation referral

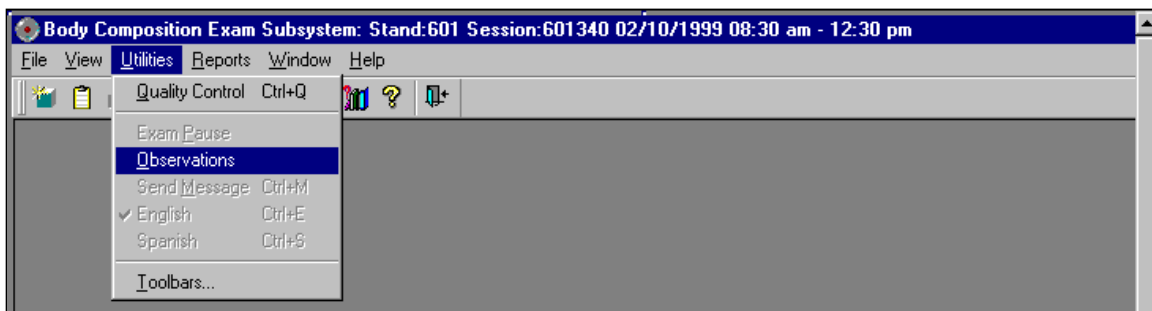

If the exam has been closed, a pick list with the names of the SPs in the current session will be displayed. (This list is displayed only if Utilities/Observations is selected when an exam is not open.) See Exhibit 5-2.

Exhibit 5-2. Pick list of SPs in current session

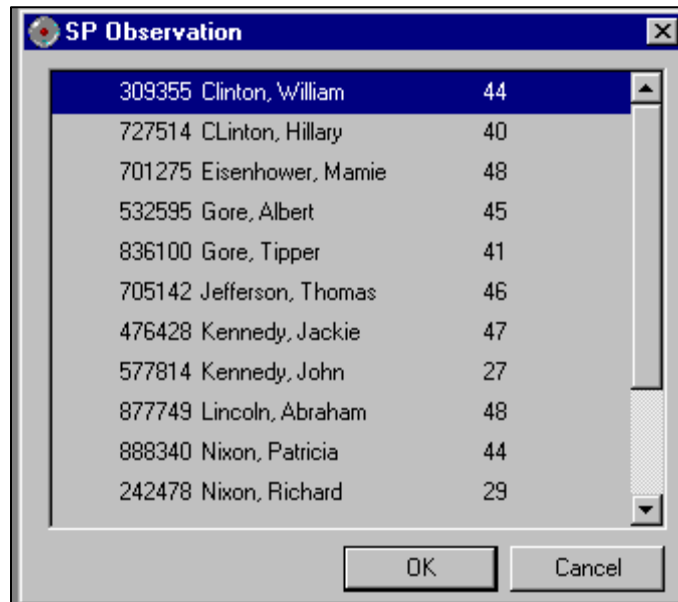

Select the name of the SP for whom an observation referral should be sent. Click OK. Exhibit 5-3 presents an example of a message to a clinician.

Exhibit 5-3. Observation referral in body composition

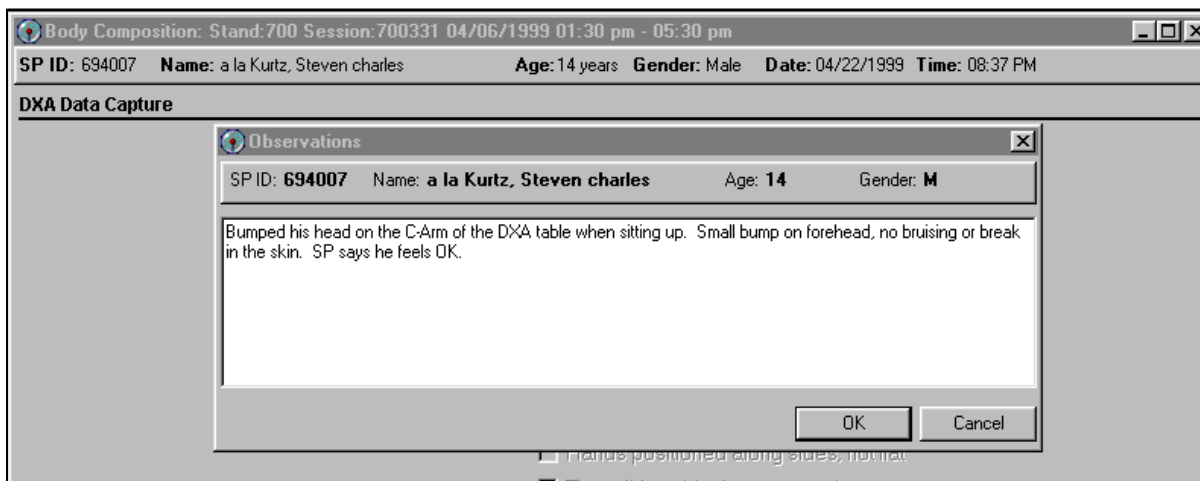

Type in the message you would like to send to the clinician. When you are finished, click OK. See Exhibit 5-4.

Exhibit 5-4 shows the referral as it appears in the Clinician's Referral Review box. The message typed in the Observation Referral box in body composition appears in this box in the Clinician

Referral Review. The clinician will review this referral and make a decision about further action if warranted; and the SP cannot be checked out of the MEC until the physician has reviewed this referral.

Exhibit 5-4. Observation referral from other components in Clinician's Referral Review box

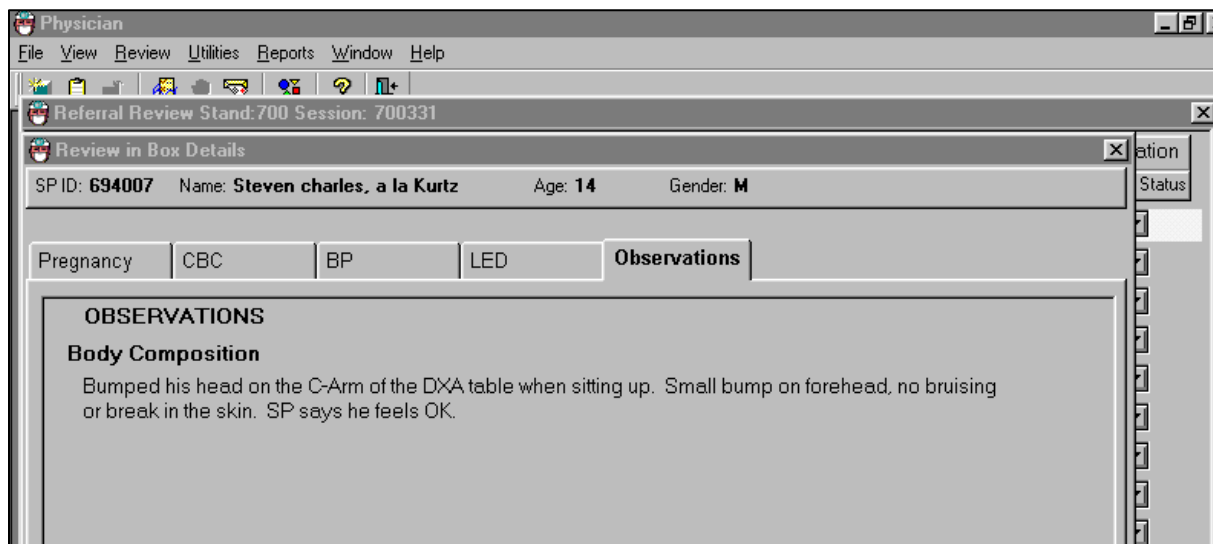

5.2 Report of Findings for DXA

Each SP will be given a report of the results or findings for the scans performed. The Report of Findings for the DXA whole body exam will include a report on the total body fat. Results will be included in the final Report of Findings sent from NCHS.

The variables reported for the whole body scan will be total percent body fat. A statement is included to inform participants that it is not currently known what percent of body fat is considered a healthy range for the public. Participants are told that researchers are working to define this range and participants are advised to discuss the results with their health care provider to find out more about what the results mean on an individual basis.

5.2.1 Sample Preliminary Report of Findings

Refer to Exhibit 5-5 for a sample of a preliminary Report of Findings.

Exhibit 5-5. Sample report of findings for body composition

Body Composition and Bone Health

The whole body scan provides information on your percent body fat.

The body composition exam results showed that your total body fat is 24.9%.

We do not know exactly what percent body fat is considered healthy for your age and gender. Researchers are working to define the healthy ranges for the public. You may want to discuss this result and your body measurement findings (page 1) with your doctor to find out what they mean for you. Too much body fat can increase a person's risk of getting diabetes or heart disease.

The bone density measurement can help spot persons who may be at greater risk for fracture because they have weaker bones. In general, a lower bone density means that the bone is weaker. Yet, not all men or women with low bone density will have fractures.

The results from your hip (left or right) scan show:

Hip bone density	0.5680 g/cm ²
T-score	-2.50

Based on diagnostic criteria as recommended by the World Health Organization and the International Society of Clinical Densitometry (1,2), your hip bone density is **very low**.

The results from your spine (lumbar) scan show:

Spine bone density	0.8440 g/cm ²
T-score	-1.80

Based on diagnostic criteria as recommended by the World Health Organization and the International Society of Clinical Densitometry (1,2), your spine bone density is **low**.

Most people develop low bone density over many years. We recommend you discuss these results with your doctor as soon as possible, since fractures due to osteoporosis often occur at sites with very low bone density. Your doctor can review your diet and lifestyle and tell you what you can do to prevent more bone loss.

1. Kanis J, Melton LJ, Christiansen C, Johnstron C, Khaltaev N. The diagnosis of osteoporosis. J Bone Mineral Research 1994;9:1137-1141. [http://onlinelibrary.wiley.com/journal/10.1002/\(ISSN\)1523-4681](http://onlinelibrary.wiley.com/journal/10.1002/(ISSN)1523-4681)

2. International Society for Clinical Densitometry. Official positions 2015 Adult and pediatric. Middletown CT <http://www.iscd.org/official-positions/2015-iscd-official-positions-adult/>

6. Quality Control

6.1 Equipment and Room Setup Checks

The equipment, room supplies, and room setup need to be checked on a regular basis. Some checks are completed daily and others need to be completed only on a weekly basis or at the beginning of each stand. These checks include calibration checks, maintenance inspection of equipment and supplies, and preparation of the room and equipment for the session exams.

Each time you log on to the application, the system will remind you to do quality control (QC) checks if the checks have not been completed for that period. The checks are to be completed daily, weekly, three times a week, and/or every stand. If you do not have time to do the checks when you log on, you can bypass this message and complete the checks later. However, this message will be displayed each time you log on until you have completed the checks for that period. Once you have completed the checks and entered this in the system, the message box with the reminder will not be displayed again until the appropriate time has passed.

An exception to the above is the QC check with the Hologic Anthropomorphic Spine Phantom. The spine phantom must be scanned daily to confirm the calibration of the densitometer before the densitometer will allow scans to be completed. If an attempt is made to perform a scan before the daily QC is completed, an error message will be displayed. Press Enter at this message and complete the spine phantom calibration.

The daily, three times a week, weekly, and start of stand checks are listed in the following sections.

6.1.1 Daily

- One spine phantom: Hologic Anthropomorphic Spine Phantom (HASP).
- Check that table scan area is clear of articles that might interfere with table movement.
- Check runner area of table to confirm the area is clear of articles that might interfere with table movement.

6.1.2 Three Times Per Week (1st, 3rd, and 5th Days of Workweek)

- Complete all daily checks.
 - One Spine Phantom.
 - One Slim-Line Whole Body Phantom.

6.1.3 Weekly

- Complete all daily checks.
 - One Spine Phantom.
- Complete the “three times weekly” scans.
 - One Slim-Line Whole Body Phantom.
- One Radiographic Uniformity.
- One Step Phantom.

6.1.4 Start of Stand

- Check that the locking pins have been removed before attempting to complete any scans.
- One Spine Phantom.
- One Step Phantom.
- One Radiographic Uniformity.
- Five Slim-Line Whole Body Phantoms.
- DXA:
 - Ten circulating spine phantoms (HSP-Q-96).
Only at the first stand of the year for each MEC.
 - Ten circulating block phantoms (NH #1).
Only at the first stand of the year for each MEC.
 - Five Hologic Whole Body Phantoms (HWBP) (WB Phantom #008).
Only at the first stand of the year for each MEC.

6.1.5 End of Stand

Clean DXA table with a very dilute solution of Ivory dishwashing detergent.

6.2 Procedures for Completing QC Scans

6.2.1 Hologic Anthropomorphic Spine Phantom (HASP)

In the Horizon A main menu (Exhibit 6-1), click on the Daily QC button. Alternatively, Daily QC can be selected from the QC pull-down menu in the main menu to start the procedure.

Exhibit 6-1. Horizon A main menu

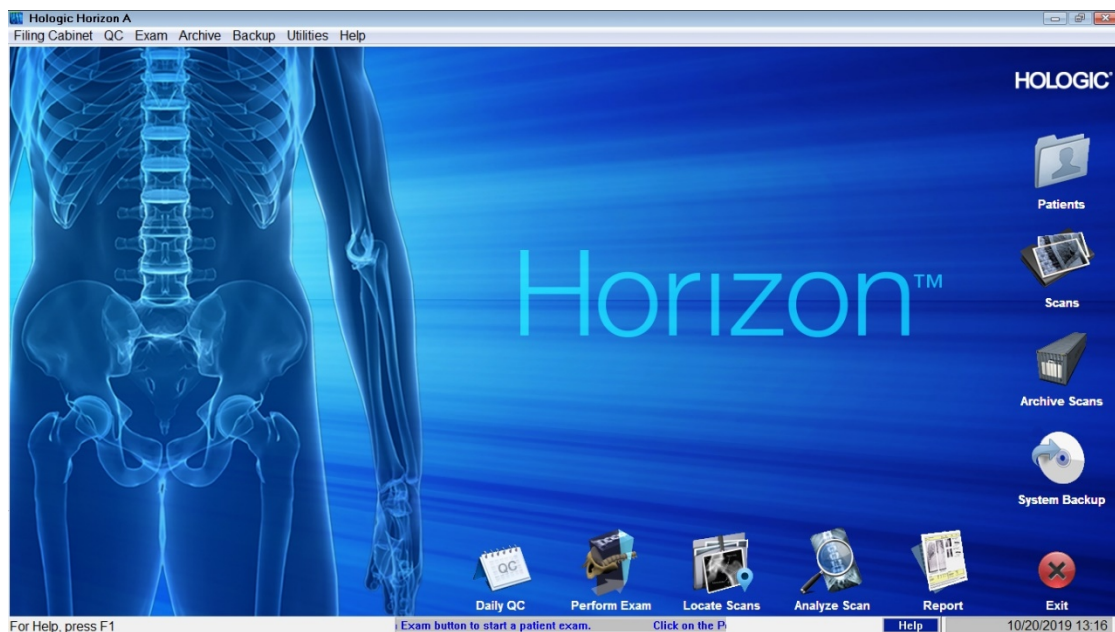

The system displays the Daily QC Setup window, prompting the placement of the spine phantom on the table. See Exhibit 6-2.

Exhibit 6-2. Daily QC Setup box

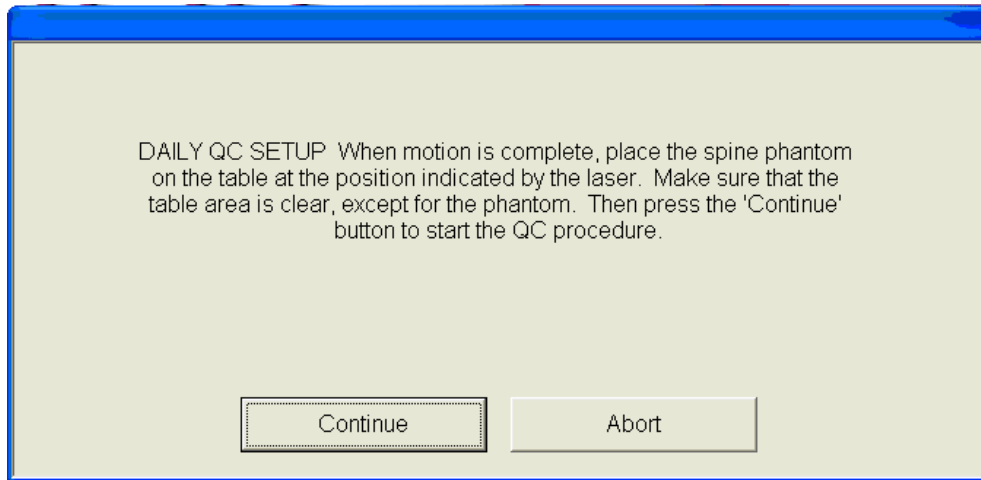

When the table motion is complete, place the spine phantom on the table with the registration mark (see A in Figure 6-1) to the bottom left. Position the phantom parallel to the back of the table.

Align the laser crosshair (see B in Figure 6-2) with the registration mark. Once the spine is properly positioned, click the Continue button. *The system starts performing an automatic test.*

Figure 6-1. Spine phantom registration mark

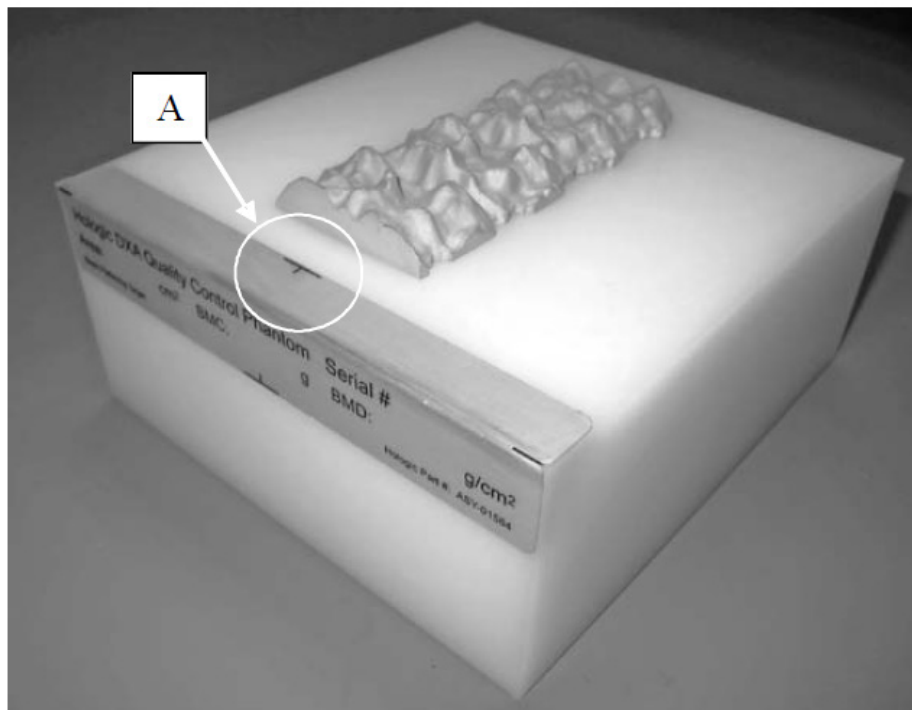
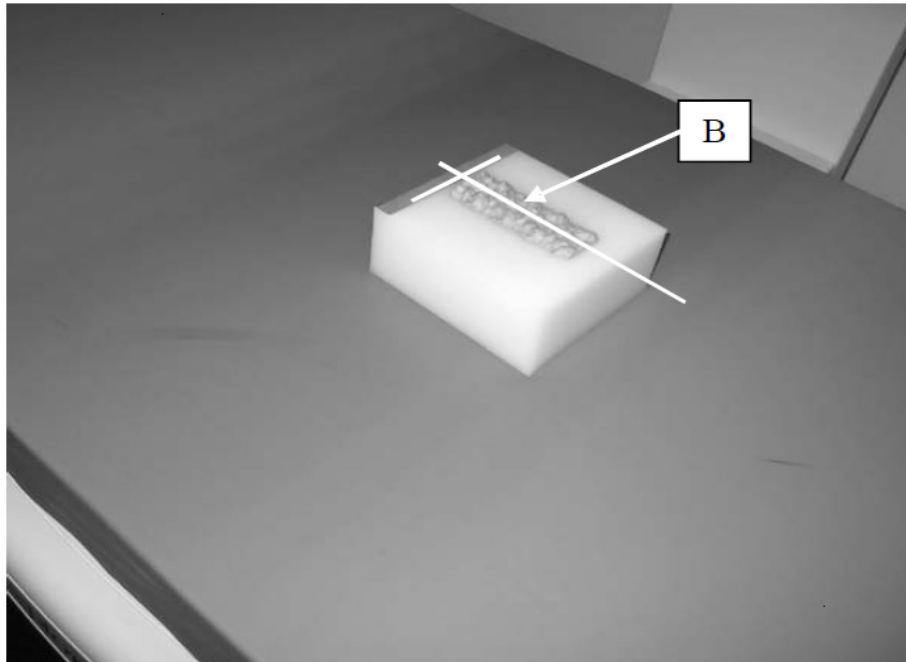
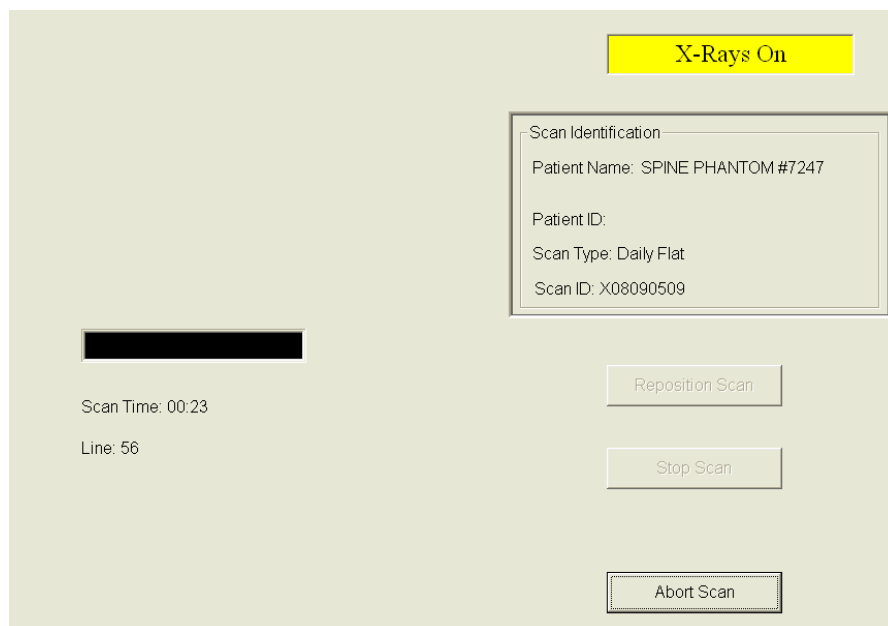

Figure 6-2. Spine phantom and laser crosshair position



The Horizon A system automatically performs a system test to verify proper operation of its X-ray subsystem prior to scanning the spine phantom. The following screen, Exhibit 6-3, is displayed during the system test.

Exhibit 6-3. System self-test



If the automatic system test succeeds, a message appears on the screen indicating that the system test passed. See Exhibit 6-4.

Exhibit 6-4. System test passed

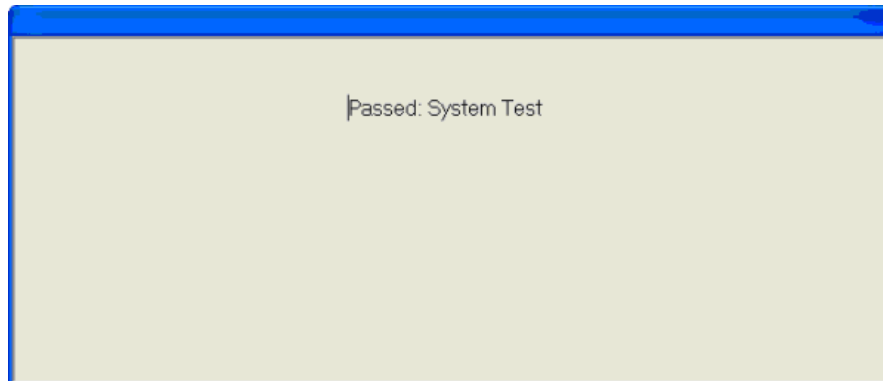

If the automatic system test fails, the system displays a message stating that the test failed, along with information on how to correct the error. Upon successful completion of the system test, the system runs an Auto QC. When Auto QC has been completed, a window appears giving either a passed or failed message. See Exhibit 6-5.

Exhibit 6-5. Auto QC passed

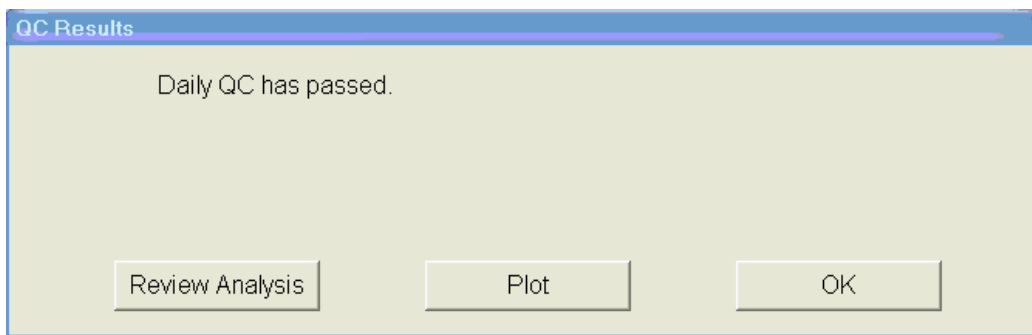

6.2.1.1 Checking Bone Mineral Density (BMD) and Bone Mineral Content (BMC)

To review the QC plot, click on the PLOT button from the QC Results window for a passed Auto QC. (See Exhibit 6-4 shown earlier.) The QC Plot window appears. Check the BMD graph for the circle for that day's scan (at far right side of graph). See Exhibit 6-6.

Exhibit 6-6. Spine Phantom QC—plot for bone mineral density (BMD)

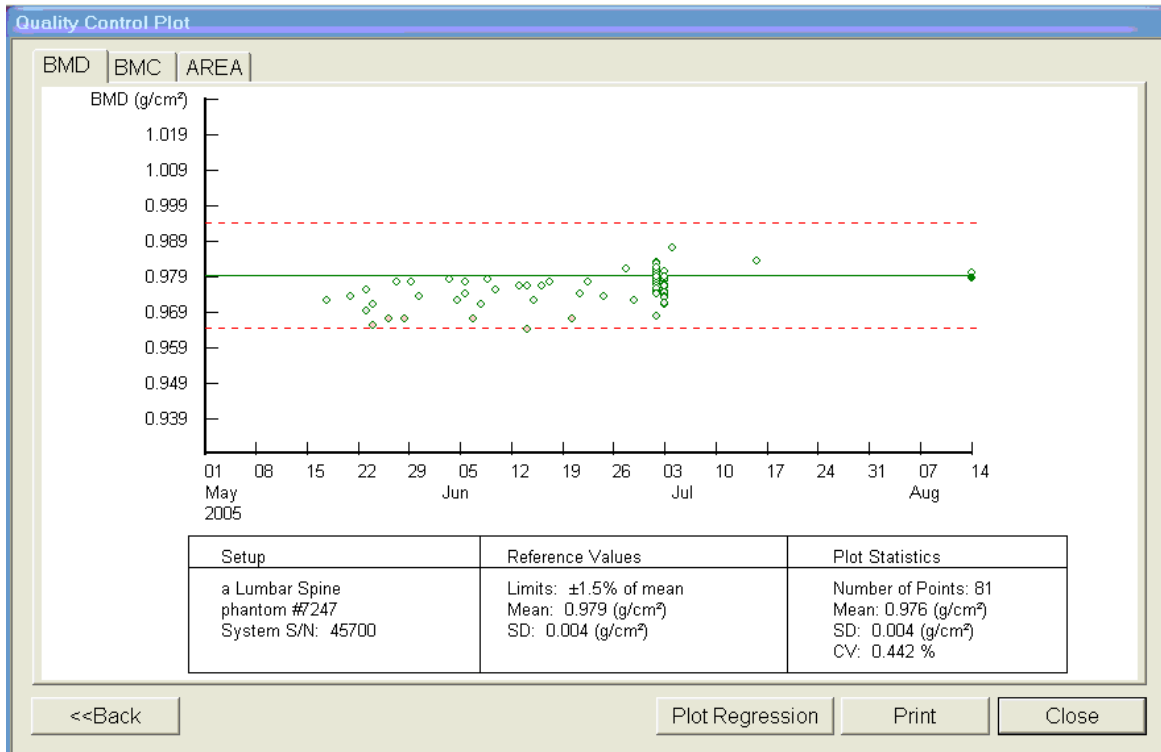

- **The circle should be within the two dotted lines.**
- **The coefficient of variation (CV) for BMD should be at or below 0.6 percent.**
- If the circle is not within the dotted lines or the CV is greater than 0.6 percent, see directions in Section 6.2.1.2.
- To check the bone mineral content (BMC), select the BMC tab at the top of the screen by clicking on it.
- Check the BMC graph for the circle for that day's scan (at the far right side of the graph). See Exhibit 6-7.

Exhibit 6-7. Spine phantom QC—plot for bone mineral content (BMC)

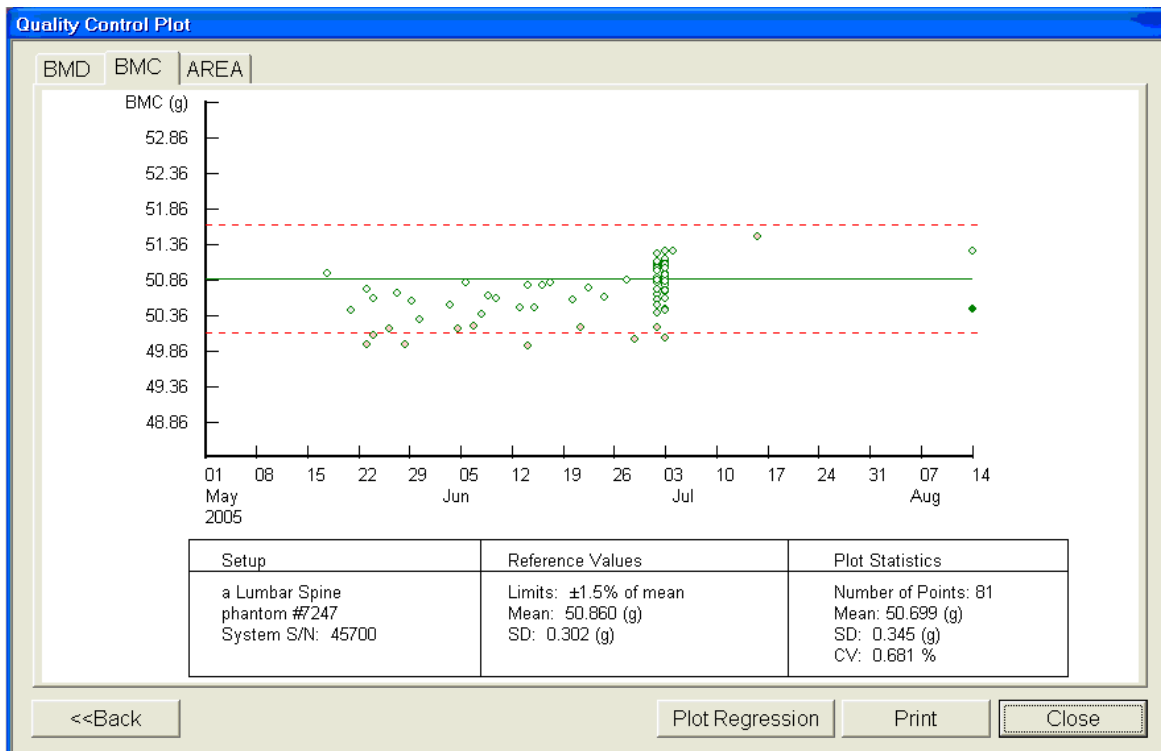

- The circle should be within the two dotted lines.
- The coefficient of variation (CV) for BMC should be at or below 0.80 percent.
- If the circle is not within the dotted lines or the CV for BMC is greater than 0.80 percent, see directions in Section 6.2.1.2.
- If the circle is within the dotted lines and the CV for BMC is at or below 0.80 percent, press BACK to return to the Auto QC Passed window or CLOSE to return to the system main menu.
- Read the messages on the Hologic computer screen. If the step phantom hasn't been scanned in the past week, a message will be displayed stating that it should be scanned following the spine phantom scan. (See Exhibit 6-8.)

6.2.1.2 Auto QC Failure

If Auto QC fails, the message will read, “Daily QC failed” and a series of steps is provided. The QC Results window contains four buttons: Details, Review Analysis, Plot, and OK. Clicking Details provides additional information about the QC failure. Click OK to return to the system main menu so Daily QC can be re-run.

If after two attempts the Daily QC continues to fail, report this to the Component Lead Health Technologist (CLHT) AND the MEC manager. This information must be reported to Hologic. The CLHT should make the call to Hologic, but may delegate this responsibility to the MEC manager if the session is busy. Record this call on the “Hologic Call Log” and stop all scans until further notice from the Hologic technician.

6.2.2 Step Phantom

Select QC from the top menu bar in the Horizon A main menu (see Exhibit 6-1 shown earlier) and select Step Phantom from the drop-down menu. A message box will prompt the setup of the Step Phantom QC. See Exhibit 6-8.

Exhibit 6-8. Step Phantom Setup window

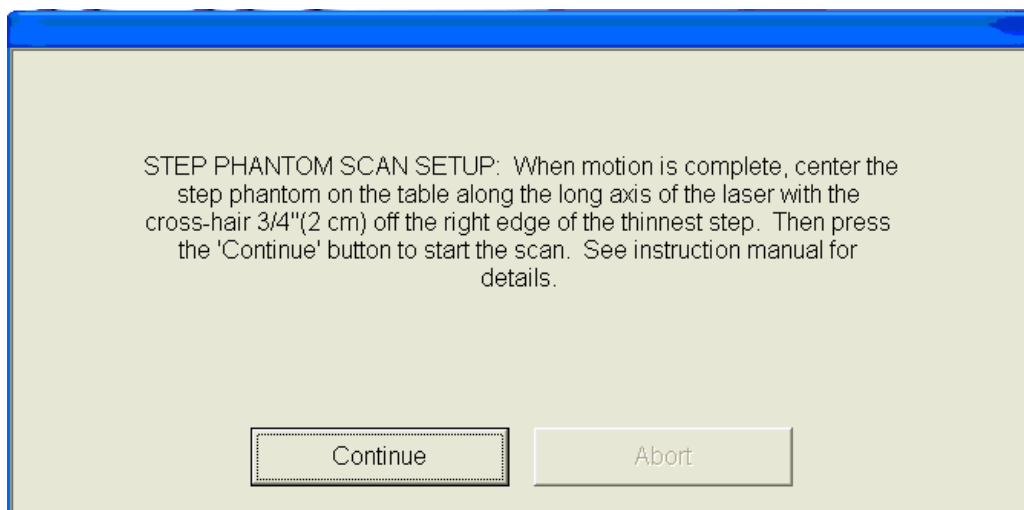

When the table motion is complete, place the body composition phantom lengthwise on the table with the thinnest step to your right as you face the table. Center the long axis of the phantom to the long axis of the laser light. Center the middle of the crosshair 3/4 of an inch from the right side of the thinnest step. Press “Continue” to start the scan. The step phantom will display in the black box in the left center of the screen. See Exhibit 6-9.

Exhibit 6-9. Step phantom scan

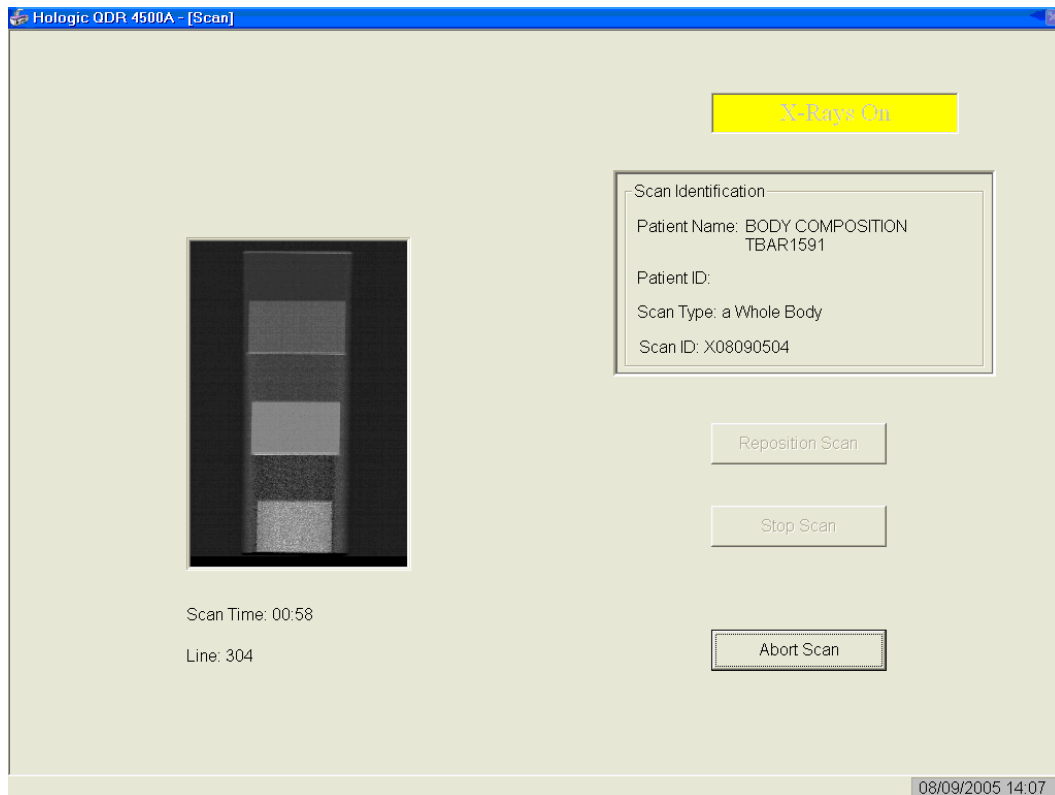

- At the conclusion of the scan, the step phantom is automatically analyzed and the data is stored in a separate file in the system.
- The system will display a message, “The step phantom evaluation was completed successfully.” See Exhibit 6-10.

Exhibit 6-10. Step phantom evaluation completed successfully

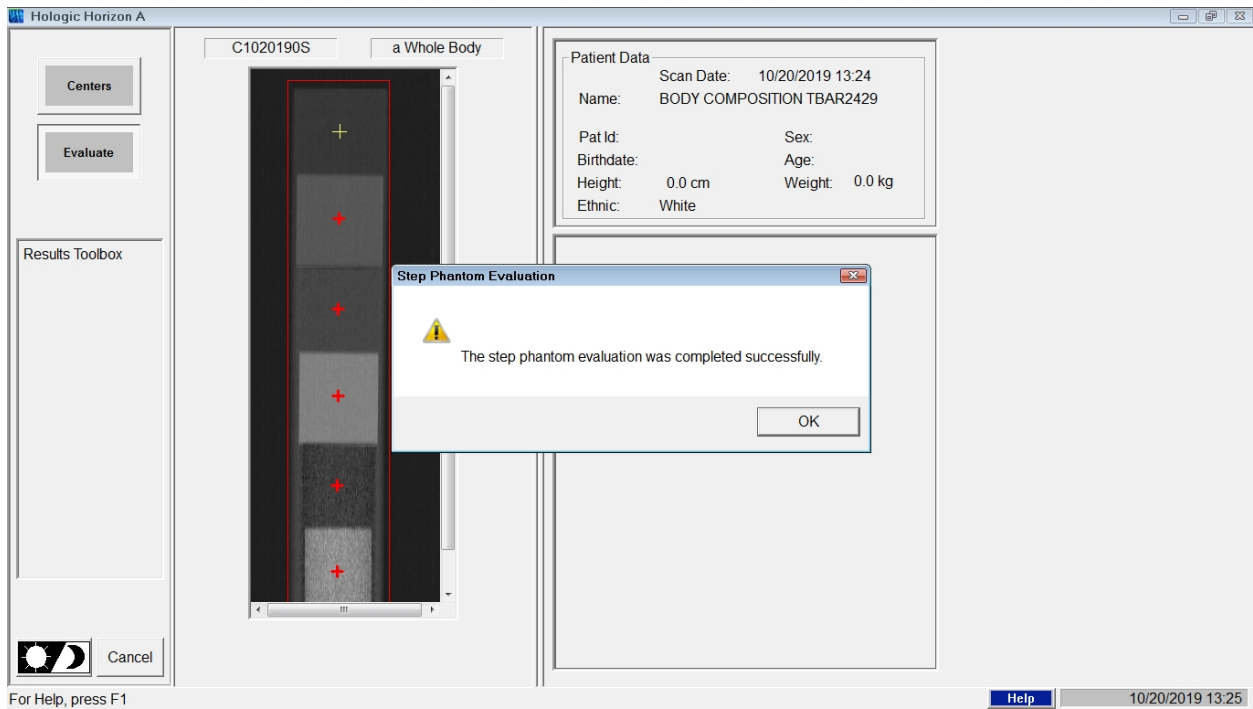

- Press OK.
- The system will display a message, “The step phantom scan for body composition calibration has been completed.” When the table has finished moving, press the Continue button to continue. See Exhibit 6-11. (If this window message continues to appear after pressing Continue, press “Abort” to return to the Horizon A main menu.)

Exhibit 6-11. Step phantom QC completed, press Continue

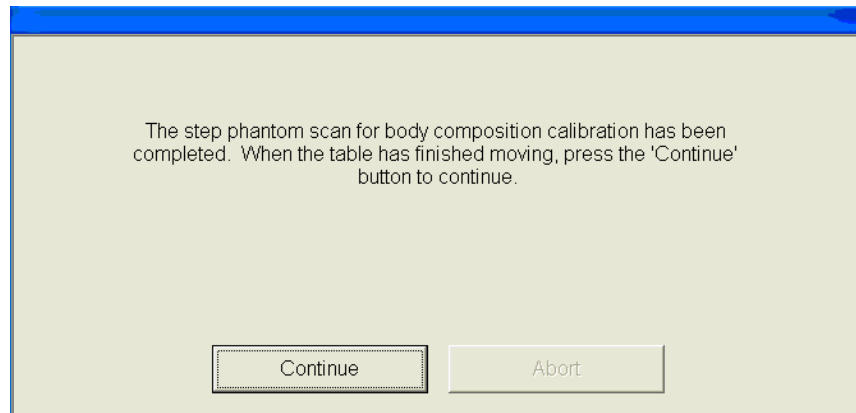

6.2.3 Radiographic Uniformity Test

After completion of the step phantom scan, an automatic prompt should come up for the Radiographic Uniformity Test. The system will analyze the scan and give you the standard deviation (SD) values for the High Air and the Low Air. Record these values in ISIS and on the QC scan log sheets. If the prompt does not come up, follow the instructions below to select the test manually.

Select “Perform Exam” from the Horizon A main menu. See Exhibit 6-1 (shown earlier). Choose or highlight “Radiographic Uniformity” from the patient list. See Exhibit 6-12. Click OK.

Exhibit 6-12. Selecting radiographic uniformity from the patient list

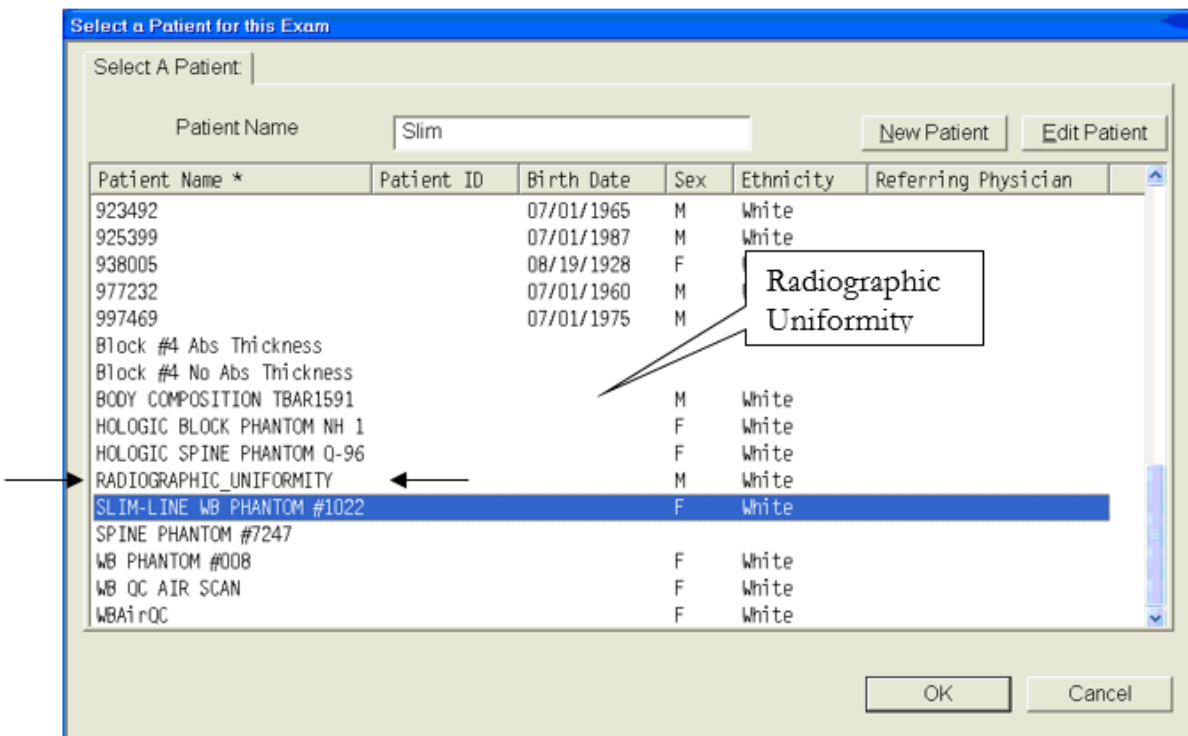

Type in initials in the white text box next to the word Operator (see Exhibit 6-13) and click OK.

Exhibit 6-13. Operator box for initials

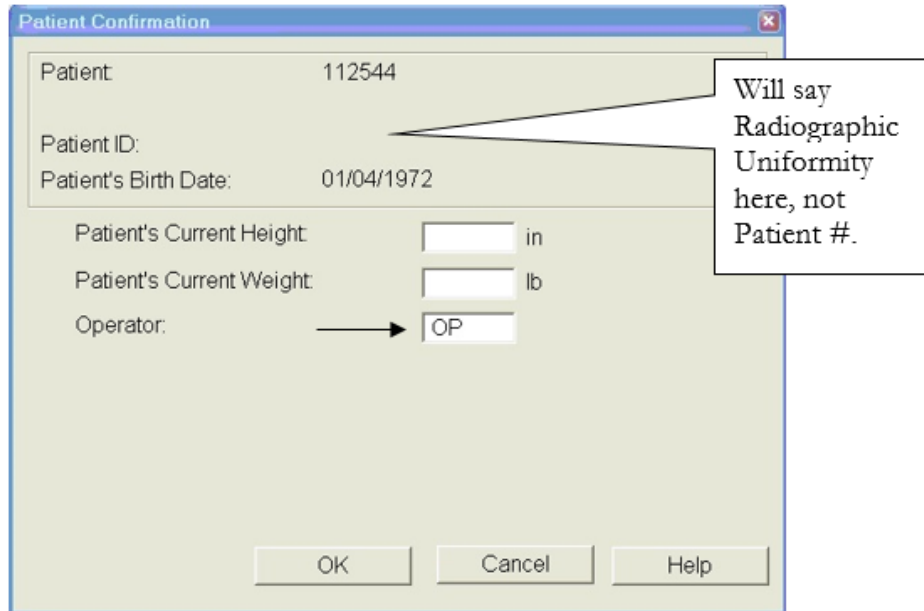

Select "Whole Body" in the Scan Selection screen. See Exhibit 6-14. Click "Next>>."

Exhibit 6-14. Selecting Whole Body in the Select Scan Type screen

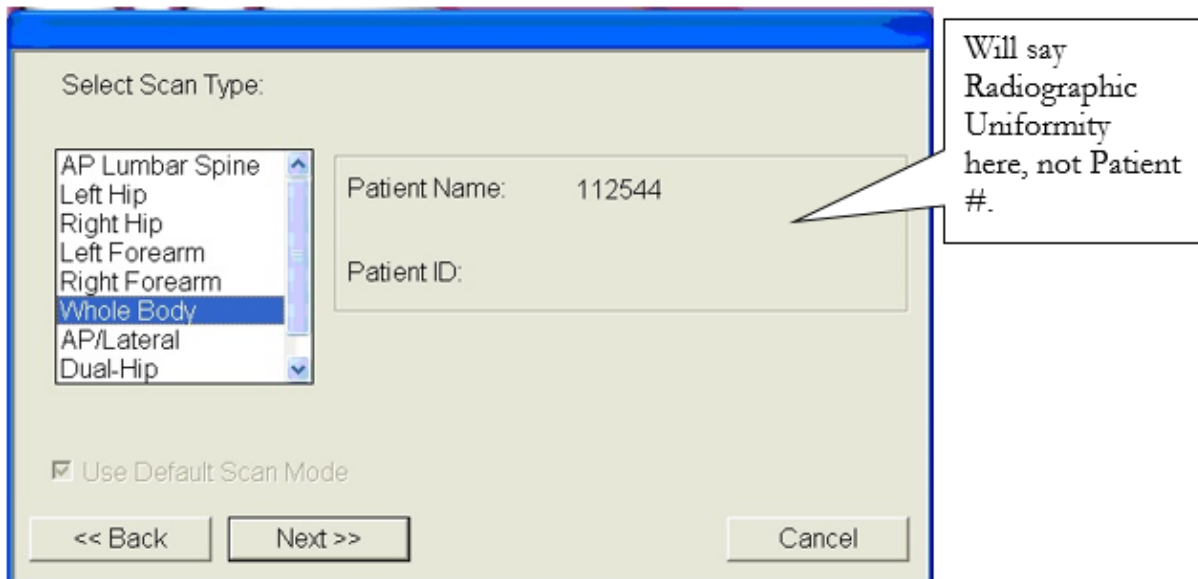

The Scan Parameters screen is displayed. See Exhibit 6-15. Clear entire table of any objects and click "Start Scan."

Exhibit 6-15. Radiographic uniformity Scan Parameters screen

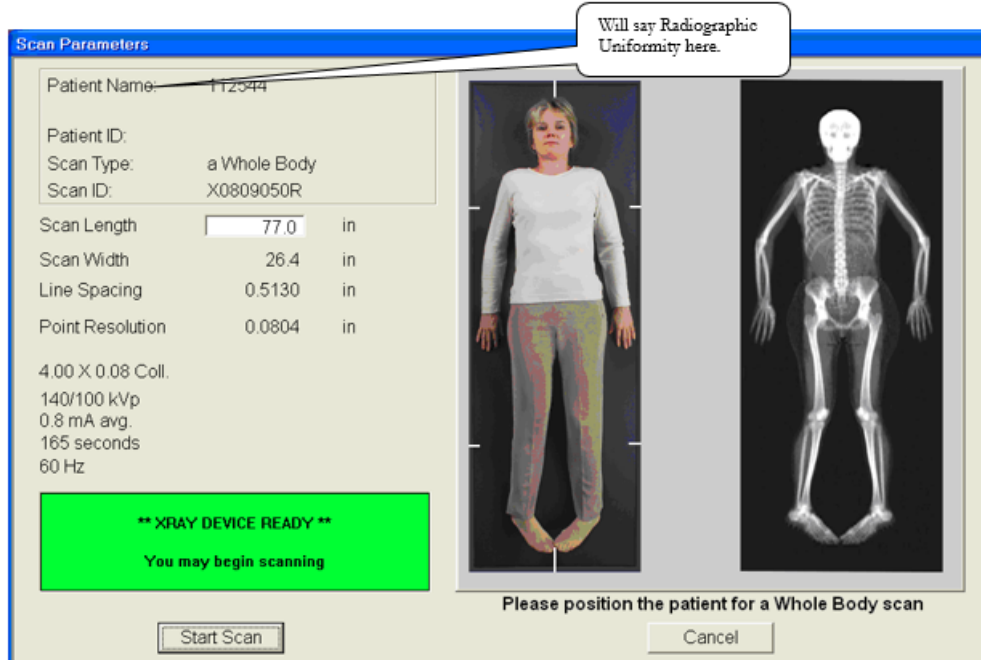

The Radiographic Uniformity will display a black box in the left center of the screen. See Exhibit 6-16. A program will automatically analyze the airscan.

Exhibit 6-16. Radiographic uniformity test

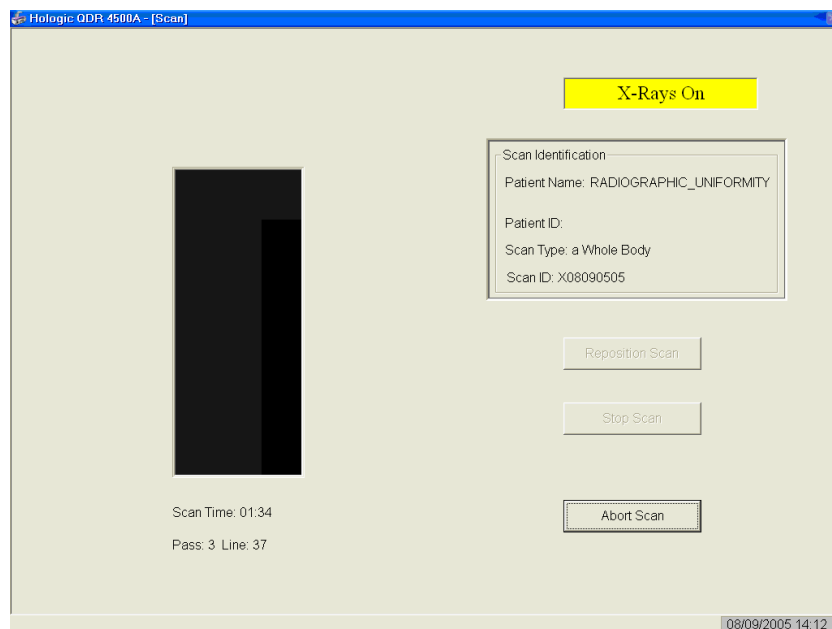

6.2.3.1 Finding the Global Standard Deviation (SD) for the Radiographic Uniformity Test (Airscaan)

- In the Horizon A main menu, select Utilities, then Service Utilities from the drop-down box, and then “Table Top Radiographic Uniformity” from the second drop-down box.
- Select or highlight the Radiographic Uniformity with the correct scan date (date of QC test). See Exhibit 6-17.

Exhibit 6-17. Selecting radiographic uniformity for SD results

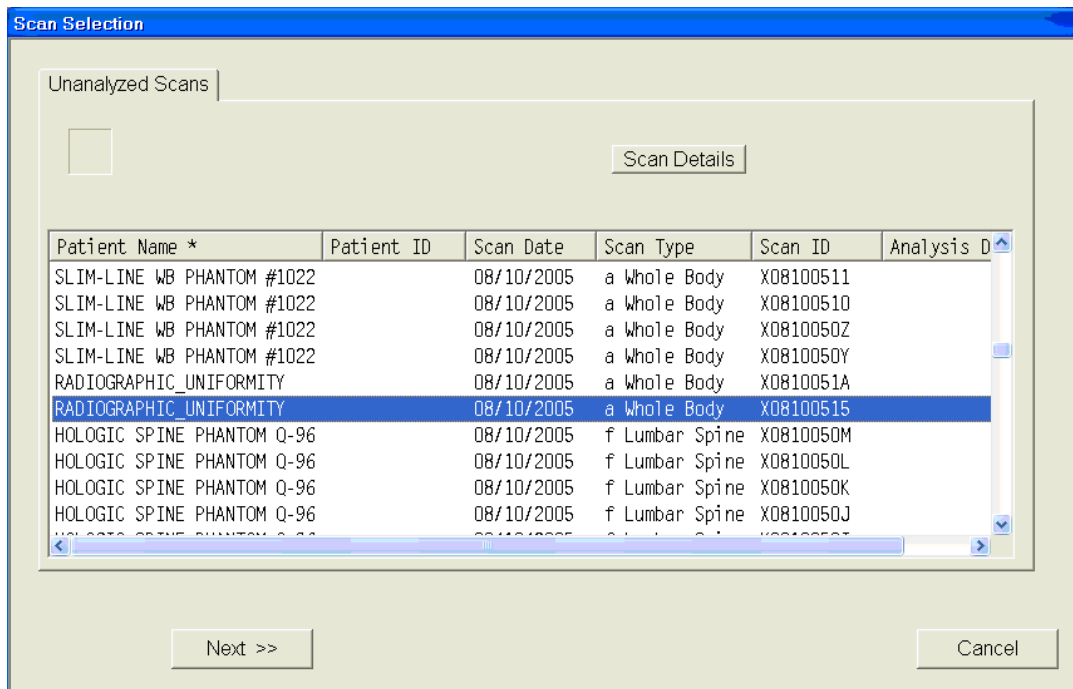

There are two SDs, a Low Air and a High Air. See Exhibits 6-18 and 6-19. Select from the tabs at the top of the window. Enter both numbers in ISIS.

Exhibit 6-18. Low air global stats SD

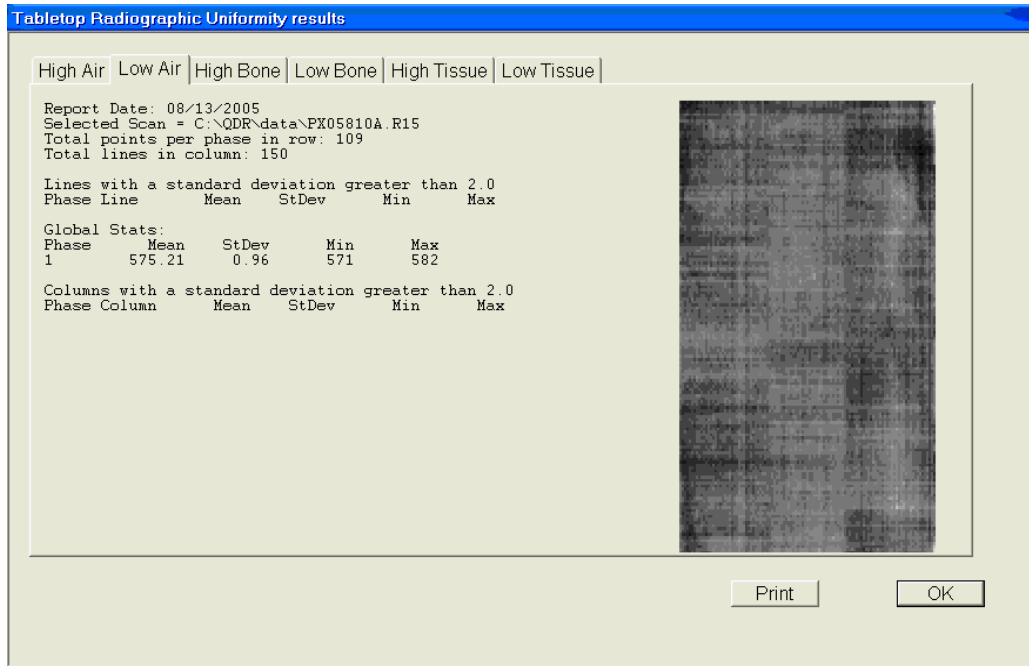
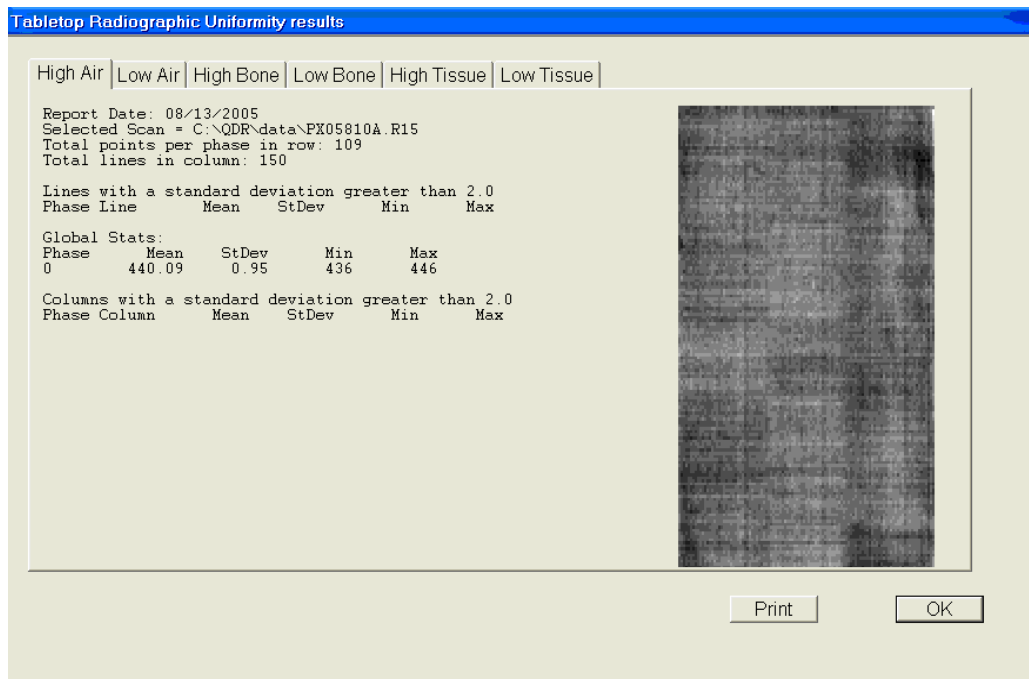

Exhibit 6-19. High air global stats SD



6.2.3.2 Procedure if Standard Deviation (SD) Is Greater Than 2.0

- Check the results of the Radiographic Uniformity Test and confirm that the scan procedure was completed correctly.
- Perform a second scan and note the results. If the standard deviation is still >2.0 , call the home office to report the results of the test and contact Hologic (see laminated instruction sheets in the DXA room for the names and numbers of the people to contact).
- Record this call on the “Hologic Call Log.” STOP all scans until further notice from Hologic.
- Notify Home Office component lead and MEC manager.

6.2.4 Slim-Line Whole Body Phantom

Lift the phantom components on and off the table, one at a time. Press the center table button to center the laser. Use the laser to assist in centering the phantom on the table.

Place the bottom layer (base) on the scanner table. (The bottom layer consists of a thin, gray PVC sheet bonded to the largest high density polyethylene [HDPE] piece.) Orient the sheet with the gray PVC on the bottom and the end marked “Head End” at the head end of the table. Place the second large white plastic piece (with beveled edges) on top of the base, using the locating pins as a guide if necessary. The second piece should be placed such that the beveled edge is in contact with the base layer, like a pyramid.

Place the medium-sized white plastic piece on the phantom. Add the second medium-sized white plastic piece (with the beveled edges), again, forming a pyramid.

Place the smallest white plastic piece on the phantom.

Add on the smallest white plastic piece (with the beveled edges) to complete the pyramid.

Secure the stack with the two locating pins. The final assembly will form a pyramid. (See Figure 6-3.) It is important that the phantom is placed in exactly the same configuration every time it is scanned.

Figure 6-3. Slim-Line whole body phantom fully assembled

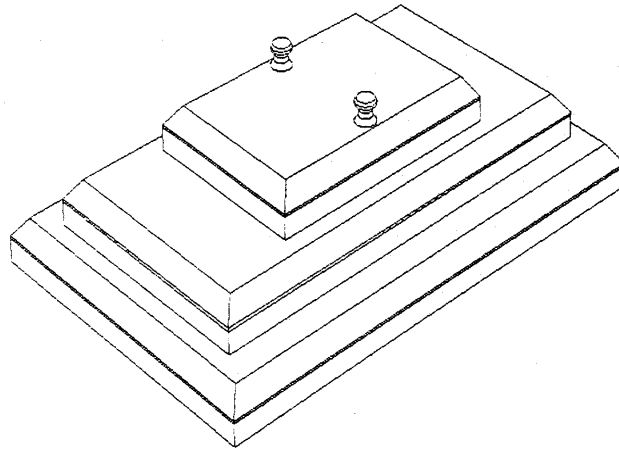

6.2.4.1 Phantom Positioning

The phantom should be centered top to bottom and side to side on the table. Use the laser to assist in centering the phantom.

6.2.4.2 Scanning the Slim-Line Whole Body Phantom (Days 1, 3, 5)

- Confirm that the phantom is centered, parallel with the long axis of the table, and is correctly oriented with respect to the head of the table.
- Confirm all artifacts are removed from the scanner table surface.
- Select “Perform Exam” from the Horizon A main menu. See Figure 6-1 shown earlier.
- Choose Phantom WB #XXXX (XXXX is 1229 on MEC 1, 1224 on MEC 2, or 1228 on MEC 3) from the list or begin typing “Slim” in the white text box next to Patient Name, and the name will highlight in the list. See Exhibit 6-20. Click OK.

Exhibit 6-20. Selecting Slim-Line WB phantom scan

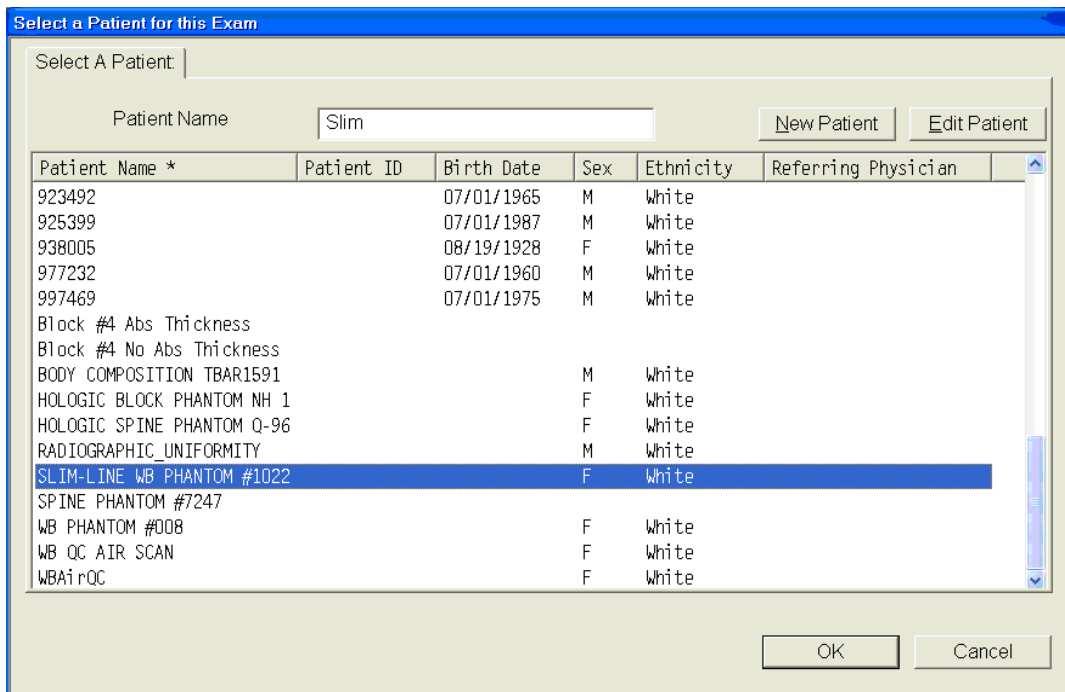

Type your initials in the white text box next to the word Operator (see Exhibit 6-21) and click OK.

Exhibit 6-21. Operator box for initials

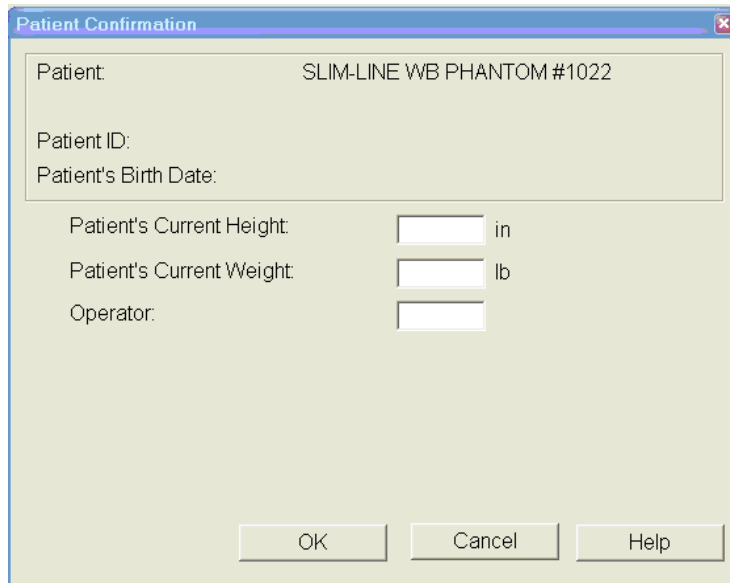

Confirm that "Slim-Line WB Phantom #XXXX" is in the Patient Field. Select "Whole Body" in the Scan Selection screen. See Exhibit 6-22. Click "Next>>."

Exhibit 6-22. Selecting Whole Body in the Select Scan Type screen

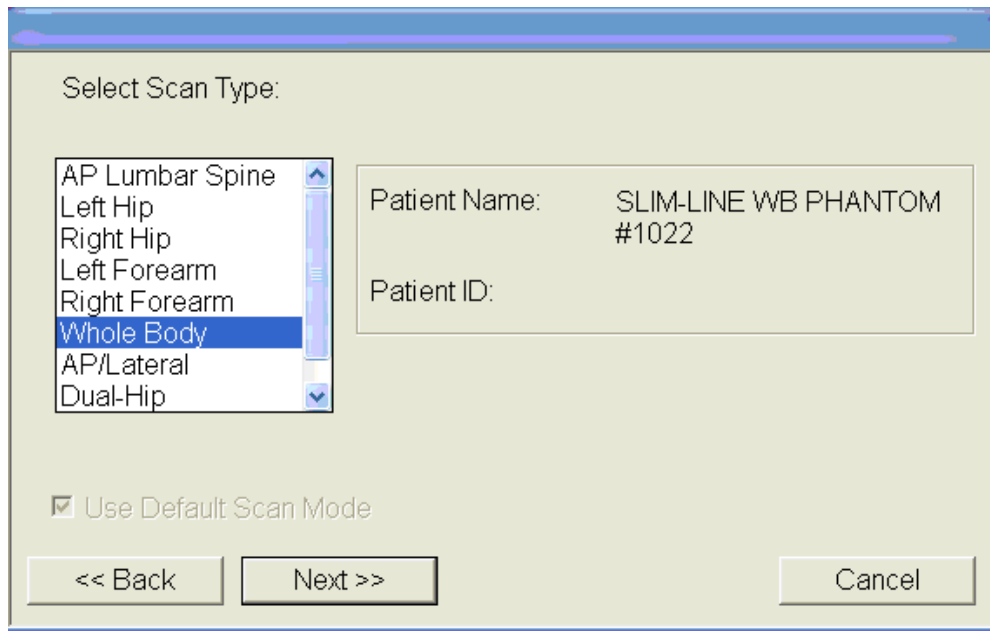

The Scan Parameters screen is displayed. Click “Start Scan.” See Exhibit 6-23.

Exhibit 6-23. Slim-Line Scan Parameters screen



The machine will scan the phantom. As the scan is completing, carefully inspect the image to ensure that the phantom was centered, parallel with the long axis of the scanner table, and the phantom's head appears at the top of the image.

If the scan is not satisfactory, reposition the phantom again, carefully following the instructions above.

6.2.4.3 Scanning the Slim-Line Whole Body Phantom for Start of Stand

Confirm that the phantom is centered, parallel with the long axis of the table, and is correctly oriented with respect to the head of the table. Confirm all artifacts are removed from the scanner table surface. Follow procedures from Section 6.2.4.2 for scanning the first Slim-Line Whole Body Phantom scan.

If the scan is satisfactory, slide the phantom down the table and then re-center. Scan four more times with repositioning between each scan, checking that each scan is satisfactory.

Note: Autoscan **cannot** be used for any of the scans.

6.2.5 Circulating HASP (HSP Q-96)

Note: This phantom is a different phantom from the one used for daily scans. Do not use the regular spine phantom that is used for daily QC scans.

Center the table. When the table motion is complete, position the Hologic Circulating Spine Phantom on the table at the position indicated by the laser cross. The positioning star should be pointing to the foot of the table (your left as you face the table). The laser cross should be centered on the positioning star. The laser line should be centered on the line between the numbers 9 and 6.

On the Horizon A Main Menu screen, click "Perform Exam." Choose Phantom Q-96 from the list or begin typing "Phantom Q-96" in the white text box next to Patient Name, and the name will highlight in the list. Click OK. Type in your initials in the white text box next to the word Operator. Click OK. CONFIRM that "MEC X Circulating Spine Phantom Q-96" is in the Patient field. Select "AP Lumbar Spine" in the Scan Selection screen. Uncheck the "Use Default Scan Mode" and Click "Next>>." In the Select Scan Mode window, select "Fast Array (f)" and click "Next >>."

The Scan Parameters screen is displayed. Click “Start Scan.” The machine will scan the phantom. Repeat these steps for the remaining scans.

6.2.6 Circulating Block Phantom (Hologic Block Phantom NH #1)

Center the table. When the table motion is complete, position the Hologic circulating block phantom on the table at the position indicated by the laser cross. The positioning star should be pointing to the foot of the table. The laser cross should be centered on the positioning star. The laser line should be positioned between the numbers 1 and 2.

On the Horizon A Main Menu screen, click “Perform Exam.” Choose MEC X Phantom Block NH #1 from the list, or begin typing “Phantom Block...” in the white text box next to Patient Name and the name will highlight in the list. Click OK. Type in your initials in the white text box next to the word Operator. Click OK. CONFIRM that “MEC X Phantom Block NH #1” is in the Patient field.

- Select “AP Lumbar Spine” in the Scan Selection screen. Uncheck the “Use Default Scan Mode” and Click “Next>>.” The application will select “Fast Array” scan mode.

The Scan Parameters screen is displayed. Click “Start Scan.” The machine will scan the phantom. Repeat these steps for the remaining scans.

6.2.7 Hologic Whole Body Phantom #008

6.2.7.1 Phantom Assembly

Lift the phantom components on and off the table one at a time. Refer to the diagram to assist in positioning the phantom correctly.

Place the bottom layer (base) of the phantom on the scanner table. (The bottom layer consists of a thin, gray PVC sheet attached to a large, white plastic sheet that contains two plastic locating pins.) Orient the serial numbers to the head end of the table. Position the bottom layer such that the gray PVC is on the bottom (the gray PVC is in contact with the table and the two alignment holes are facing out of the plane of the table toward the ceiling).

Place the second large white plastic piece on top of the phantom base, using the alignment holes as a guide. This piece should be placed such that the beveled edge forms a 45° angle with the base, with the serial numbers oriented to the head of the table. Next, place the medium-size white plastic pieces on the phantom, with the top-medium piece forming a 45° angle with the bottom-medium piece. Make sure the serial numbers are toward the head of the table.

Place the small, white plastic pieces on top to resemble the medium and large setup. Insert the locating pins through the alignment holes. The final assembly will form a pyramid (refer to the diagram, side view). Check that the phantom configuration is positioned exactly as outlined.

6.2.7.2 Phantom Positioning

Position the phantom in the center of the scanner table. Put the head of the phantom at the head of the table. Place the phantom's head 24 inches from the table head. (The head of the phantom is the end that has the phantom serial number label attached to it.) Carefully position the phantom parallel with the long axis of the table, using the table pad markings as a guide.

6.2.7.3 Scanning the Whole Body Phantom

Confirm that the phantom is centered, is parallel with the long axis of the table, and is correctly oriented with respect to the head of the table. Confirm that all artifacts are removed from the scanner table surface.

On the Horizon A Main Menu screen, click “Perform Exam” at the bottom of the screen. Choose WB Phantom #008 (008 is the serial number of the Whole Body Phantom) from the list or begin typing WB... in the white text box next to Patient Name and the name will highlight in the list. Click OK. Type in your initials in the white text box next to the word Operator. Click OK. Confirm that “WB Phantom #008” is in the Patient field. Select “Whole Body” in the Select Scan Type box. Click “Next >>.”

The Scan Parameters screen is displayed. Click “Start Scan.” The machine will scan the phantom (Figures 6-4 and 6-5).

Figure 6-4. Layout of whole body phantom—top view

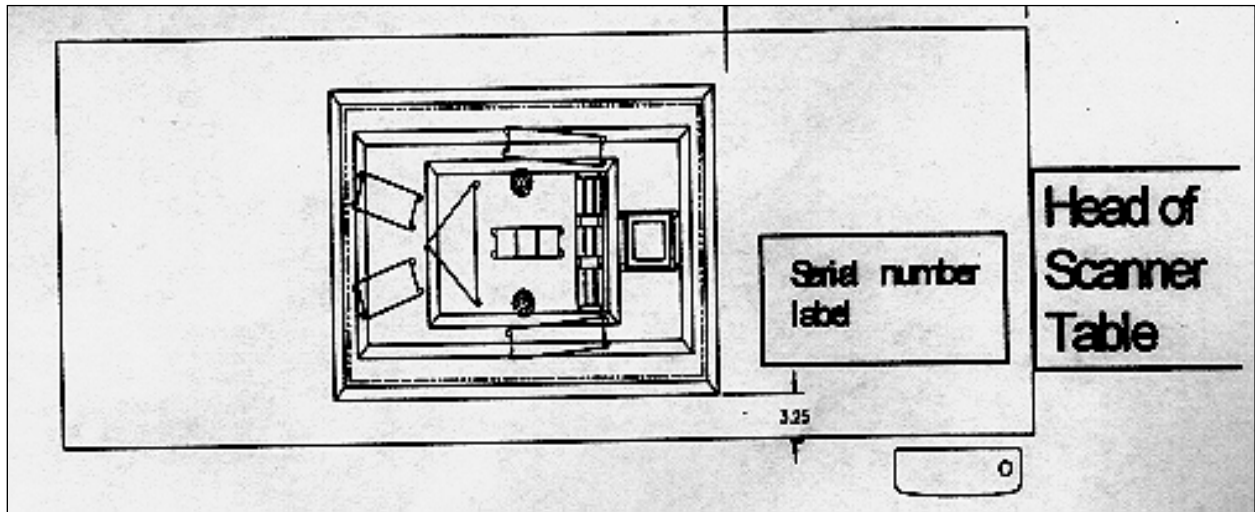
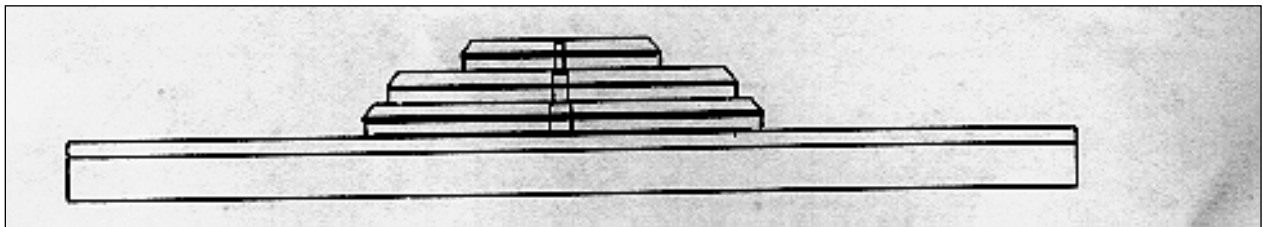

Figure 6-5. Layout of whole body phantom—side view



Carefully inspect the scan image to ensure that the phantom was centered and parallel with the long axis of the scanner table, and that the phantom's head appears at the top of the image. If the scan image was not satisfactory, click "Abort" and reposition the phantom again, carefully following the instructions above. A total of five scans should be completed.

6.3 QC Scan Checklists

The QC Scan checklists were developed to ensure that all QC scans are completed as outlined in the protocol. There are two forms: one is used for all daily, three times/week, and weekly QC scans; the other is used for all Start of Stand QC scans. See Appendixes F and G for sample forms.

6.3.1 Instructions for Completing the Weekly QC Scan Checklist

The checklist should be filled out on each day of the workweek by the health technologist who is responsible for completing the QC scans that week. As scans are completed each day, check the appropriate boxes.

During the week, keep the checklist in the Body Composition Procedures manual. At the end of each week, file the completed form in the Weekly QC Scans Checklist section in the back of the manual, behind the previous week's form.

6.3.2 Instructions for Completing the Start of Stand QC Scan Checklist

The checklist should be filled out at the start of the stand by the health technologist who is responsible for completing the start of stand scans. As each scan is completed, check the appropriate box.

File the completed form in the Start of Stand QC Scans Checklist section in the back of the manual, behind the form from the previous stand.

6.4 Data Entry Screens for QC on Equipment

When you log on to the application before the quality control checks are performed, the system displays a message, "One or more of your QC checks have not been performed." See Exhibit 6-24. Click OK for this message.

Exhibit 6-24. Quality Control Reminder Message box

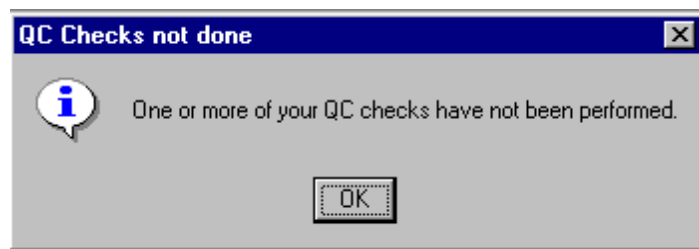

When you want to complete the QC checks, select Utilities. Then select Quality Control from the menu. See Exhibit 6-25.

Exhibit 6-25. Utilities menu to select quality control

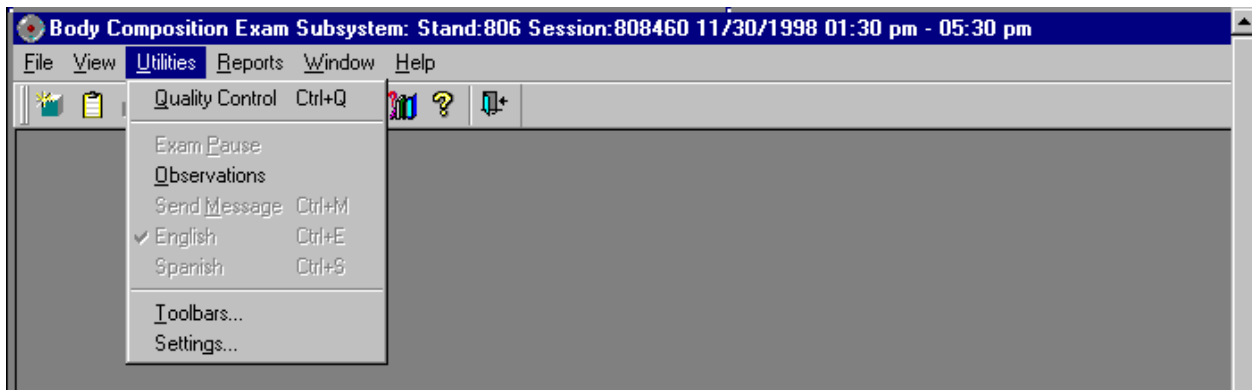

- Clicking on the QC icon from the Toolbar can also access the QC screens.
- When QC is selected from the Utilities menu, the User ID entry box will be displayed. See Exhibit 6-26.

Exhibit 6-26. Quality control logon

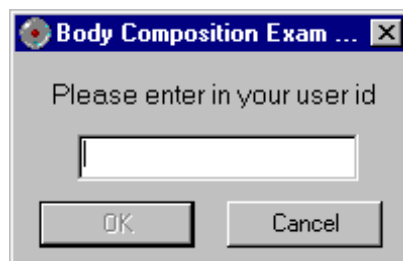

Each technologist will have a personal ID. This ID will be used to identify the person who completed the QC checks for this period. Enter your User ID and click OK.

If you do not want to do the QC checks at this time, click Cancel.

6.4.1 QC Daily Checks

The Daily QC Check Data Entry screen is shown in Exhibit 6-27.

Exhibit 6-27. Quality control daily checks

QC Check	Done	Result	Comment
DXA - check table scan area is clear of articles that might interfere with table movement.	<input type="checkbox"/>		
DXA - check runner area of table is clear of articles that might interfere with table movement.	<input type="checkbox"/>		
DXA - complete spine phantom check.	<input type="checkbox"/>		
DXA-complete 1 slim-line WB phantom scan on Days 1, 3, and 5. (Result= 'Done' on days 1,3,5; N/A on other days.)	<input type="checkbox"/>		

On the QC screens, check “Done” for the listed items when that item has been completed. You are not required to enter anything in the “Result” or “Comment” fields unless there is a problem.

The “Result” field is used to enter values for selected QC items if required. The Comments field is used to enter information about problems encountered with the QC item check. Use the scroll bar to move to the remaining items. When you are finished with the daily item checks, click OK to close the QC box.

6.4.2 QC Weekly Checks

The Weekly QC Check Data Entry screen is shown in Exhibit 6-28.

Exhibit 6-28. Quality control weekly checks

QC Check	Done	Result	Comment
System backup	<input type="checkbox"/>		
1 Step Phantom	<input type="checkbox"/>		
1 Radiographic Uniformity scan	<input type="checkbox"/>		
Complete all daily checks.	<input type="checkbox"/>		

Complete all the daily checks. Check “Done” for each item on the weekly checks when complete. Use the Scroll Down bar on the right of the screen to get to the remaining items.

If you notice a problem with any of the items on the checklist, make a note of this in the Comment box and report it to the chief tech AND the MEC manager.

6.4.3 QC Start of Stand Checks

The QC Start of Stand Check Data Entry screens are shown in Exhibits 6-29 and 6-30.

Exhibit 6-29. Quality control start of stand checks (1)

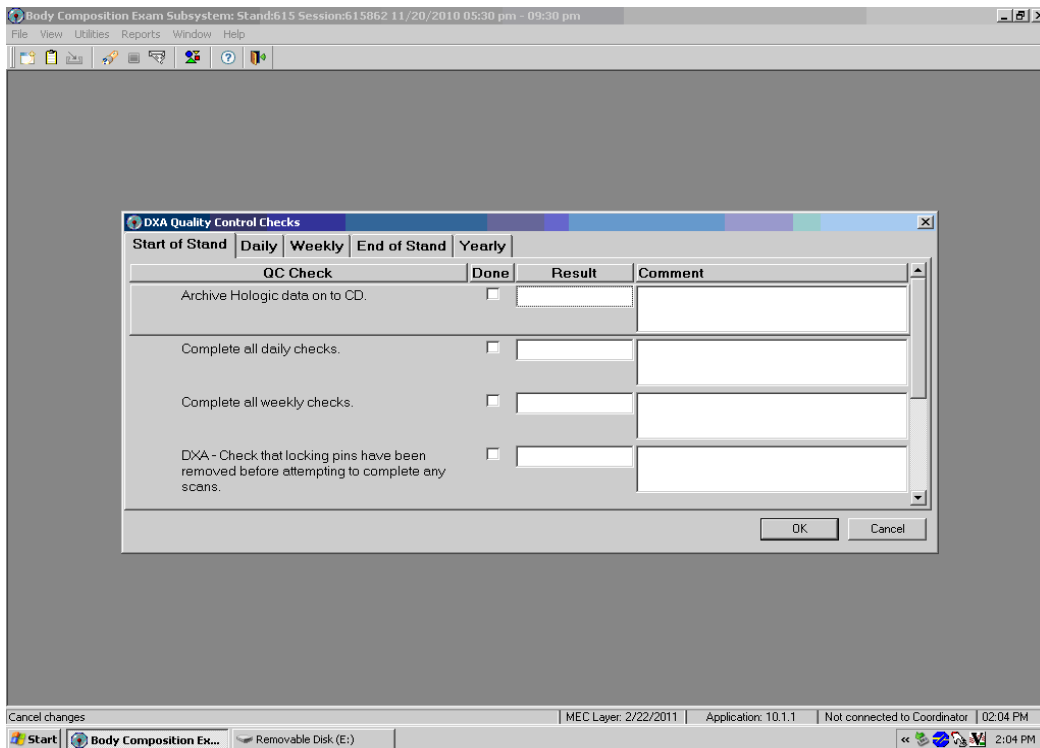

Exhibit 6-30. Quality control start of stand checks (2)

The screenshot shows a software window titled "DXA Quality Control Checks" with a blue header bar. Below the header are four tabs: "Start of Stand", "Daily", "Weekly", "End of Stand", and "Yearly". The "Start of Stand" tab is selected. The main area contains a table with four columns: "QC Check", "Done", "Result", and "Comment". There are four rows of checks, each with an unchecked checkbox in the "Done" column, an empty text box in the "Result" column, and an empty text box in the "Comment" column. At the bottom right of the window are "OK" and "Cancel" buttons.

QC Check	Done	Result	Comment
DXA - Check that locking pins have been removed before attempting to complete any scans.	<input type="checkbox"/>		
1 Radiographic Uniformity scan	<input type="checkbox"/>		
1 Step phantom - this is a whole body phantom	<input type="checkbox"/>		
5 Slim Line Whole Body Phantom scans	<input type="checkbox"/>		

Complete all Start of Stand checks. Start of Stand checks include all daily and weekly checks. When the Start of Stand checks are complete, click OK to close the QC checks.

6.4.4 QC Yearly Checks

The Yearly QC Data Entry screen is shown in Exhibit 6-31. Complete all of the yearly checks at the beginning of the year for each MEC. When the yearly checks are complete, click OK.

Complete the remaining Start of Stand checks. When you have completed all checks, click OK to close the QC box.

Exhibit 6-31. Quality control yearly checks

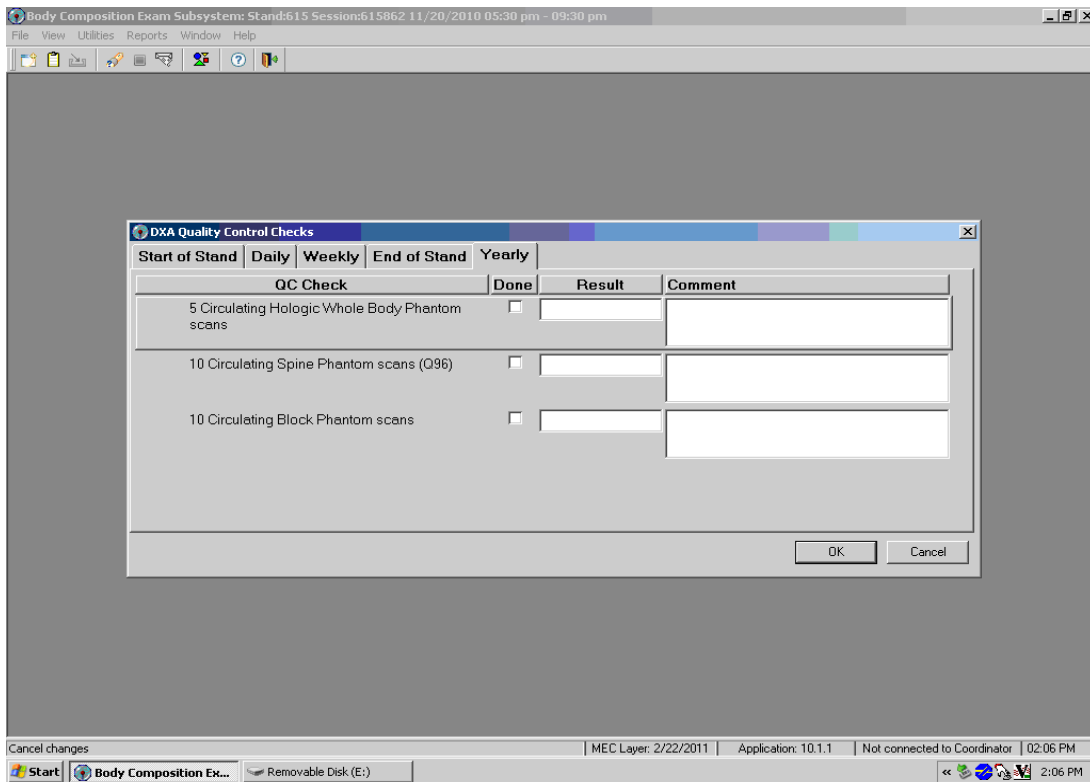

6.4.5 QC End of Stand Checks

Clean the DXA table by wiping it down with a clean damp cloth and liquid Ivory soap. Do not complete this item until all exams for the stand have been completed to ensure that no scans are done on a damp table. See Exhibit 6-32.

Exhibit 6-32. Quality control end of stand checks

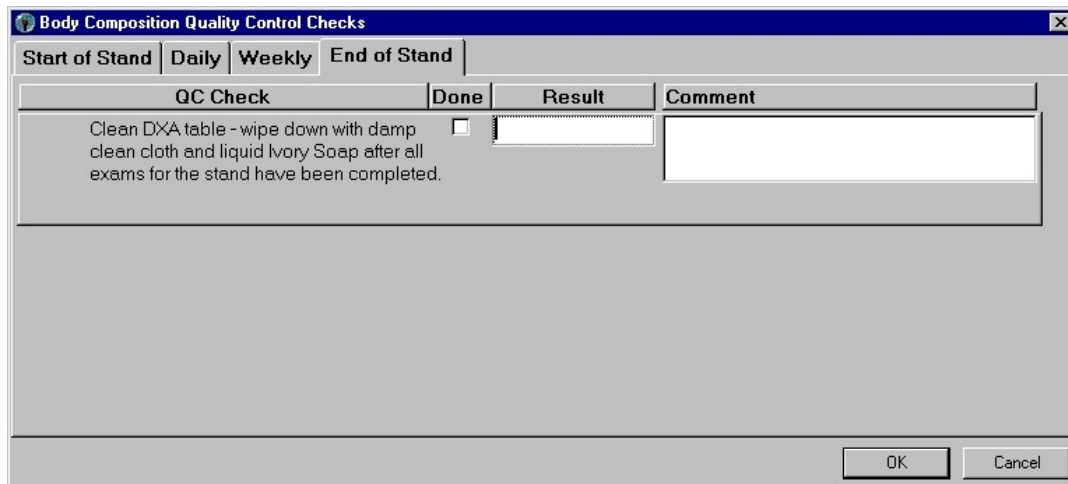

If the table needs to be cleaned more often, follow the procedures for end of stand cleaning at the end of the examination week. This will allow the table to dry prior to the beginning of the next week.

6.4.6 Incomplete QC Checks

If you do not check that all items are complete, the system will display this message, “Not all of the QC items were done. Do you wish to exit?” See Exhibit 6-33.

Exhibit 6-33. Quality control incomplete entry

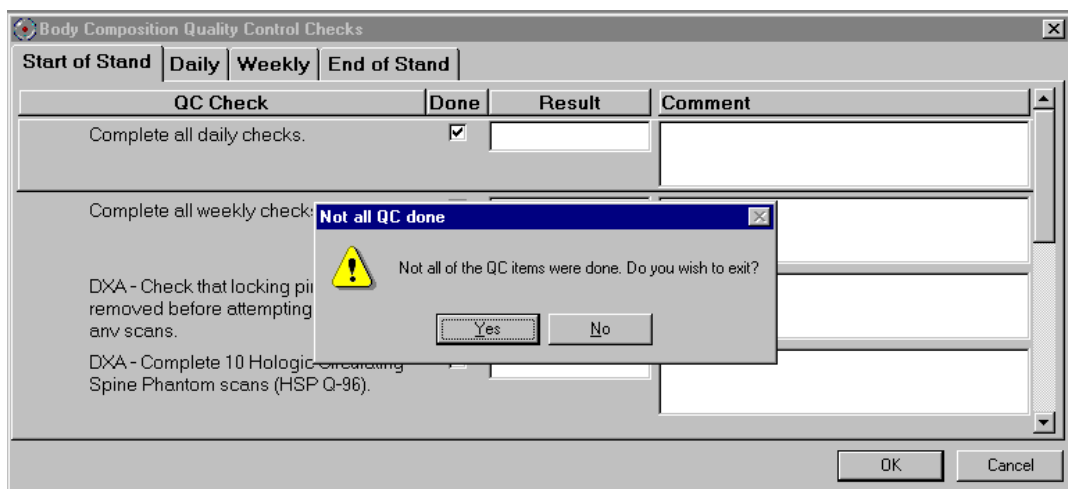

If you want to complete the items before exiting, click “No” to this message and complete the items. If you wish to exit without completing all the QC checks, click “Yes” to this message.

If all QC items were not complete, the system will remind you each time you log on that the QC checks are not complete.

Appendix A
DXA Scripts

Appendix A

DXA Scripts

Suggested Introduction to Component (English Version)

In this room, we are going to take a scan of your body that will tell us about your body composition. I will explain in more detail as I do the exam. Please have a seat up here on the table and get as comfortable as possible. I am going to ask you a few questions before I start the exam.

Suggested Explanation of Whole Body DXA Scan (English Version)

For this examination, I will be doing a scan of your body with this machine. It will tell us about your body composition. Now please lie down on the table and I will position you for the scan. I'm going to pull up on your shoulders to straighten you. I will position your arms and feet correctly for the scan and will wrap these Velcro straps loosely around your ankles to hold them in place. The scan will take about 3 minutes to complete and you will not feel anything except for the table movement. As the machine scans your body, the table will move up and down and back and forth. This overhead arm (the C-arm) will also be moving. To receive a good quality scan, it is important that you lie perfectly still during the scan and do not talk.

Suggested Explanation After Completion of Scans (English Version)

Please stay lying down until I have moved the overhead arm out of the way. Now you can sit up. You will receive the results in the mail in 12-16 weeks. Let's find out where you go next.

Suggested Introduction to Component (Spanish Version)

En esta habitación, le haremos uno o más exámenes del cuerpo que nos dirán cómo es la composición de su cuerpo. Se lo explicaré con más detalle mientras hago los exámenes. Por favor, siéntese aquí, sobre la mesa y póngase lo más cómodo(a) posible. Le voy a hacer algunas preguntas antes de hacerle el examen.

Suggested Explanation of Whole Body DXA Scan (Spanish Version)

Para este examen, le voy a hacer un escáner del cuerpo con esta máquina. Nos dirá cómo es la composición de su cuerpo. Por favor, acuéstese sobre la mesa y lo(a) voy a poner en la posición correcta para el examen. Le voy a subir ligeramente de los hombros para enderezarle. Le voy a poner los brazos y los pies en la posición correcta y después le pondré esta cinta Velcro, no muy apretada, alrededor de los pies para sostenerlos en su lugar. El escáner durará unos 3 minutos y usted no sentirá nada excepto el movimiento de la mesa. Mientras el escáner pasa por su cuerpo, la mesa subirá, bajará y se moverá hacia adelante y atrás. Este brazo proyector también se estará moviendo. Para poder recibir una imagen de buena calidad, es importante que no se mueva. Por favor, no hable durante el escáner.

Suggested Explanation after Completion of Scans (Spanish Version)

Por favor quédese acostado(a) hasta que yo retire el brazo proyector. Ya se puede sentar. Recibirá los resultados por correo dentro de 12 a 16 semanas. Déjeme ver adónde tiene que ir ahora.”

Appendix B
Shared/Screening/Safety/Exclusion
Questions (Spanish Translation)

Appendix B

Shared/Screening/Safety/Exclusion Questions (Spanish Translation)

Shared Exclusion Questions (Screen 1)	
English	Spanish
Do you have a pacemaker or automatic defibrillator?	¿Tiene un marcapaso o desfibrilador automático?
Are you currently pregnant?	¿Está usted actualmente embarazada?
In the past 7 days, have you had any X-rays or scans that used contrast material such as dyes or barium?	En los últimos 7 días, ¿le han tomado a usted alguna radiografía, tomografía o escáner que usara material de contraste como colorantes o bario?
Do you have any amputations of your legs or feet other than toes?	¿Tiene alguna amputación de las piernas y pies que no sean los dedos de los pies?
Where is the amputation?	¿Se refiere a la cadera derecha, izquierda o las dos caderas?
Screening Questions (Screen 2)	
English	Spanish
Have you removed all jewelry, eyeglasses, hair ornaments, and other objects from your hair and body?	¿Se ha quitado todas las joyas, anteojos, adornos para el pelo y otros objetos del pelo y del cuerpo?
Have you removed wallets, keys, and other objects from all of your pockets?	¿Ha sacado su billetera, llaves y otros objetos de todos sus bolsillos?
Do you have any artificial joints, pins, plates, metal suture material, or other types of metal objects in your body?	¿Tiene usted alguna articulación artificial, clavo ortopédico, placa ortopédica, material de metal para puntos de sutura, u otro tipo de objeto de metal en el cuerpo?
Are you using an insulin pump or do you have insulin lines now?	¿Está usando una bomba de insulina o tiene sondas de insulina ahora?
Do you have an ostomy, such as an ileostomy or colostomy?	¿Tiene usted una ostomía, o sea una pequeña abertura, tal como una ileostomía, abertura en el intestino delgado, o colostomía, abertura en el colon?
Are you wearing a hearing aid now?	¿Está usando _____ audífono/ayuda auditiva ahora?
Have you removed your bra? Wearing a bra may affect the results of your tests. "Could you remove it please?"	¿Se quitó el sostén o brasier? No quitárselo puede afectar los resultados de sus pruebas. "¿Puede quitárselo, por favor?"

Appendix C

Setup Procedures for Body Composition/DXA Room

Appendix C

Setup Procedures for Body Composition/DXA Room

Unlock Carriage and Rotation Locks (Three Locking Pins)

Technologist/FES

- Unlock the carriage lock located on the left side of the C-arm carriage (around the left gas spring).
- Unlock the C-arm lock.
- Unlock the table locking pin located on the upper-left side of the table (front side of scanner).
- Remove the laminated signs from the C-arm and Hologic computer screen and put them in the supply bin in the belly compartment.

Remove C-Arm Stabilizer

Technologist/FES

- Remove the Velcro strap from the stabilizer under the C-arm.
- **Gently** remove the stabilizer from its position.
- The stabilizer is stored in the supply bin in the belly compartment during the stand.
- C-arm must be unbolted from locking pins before any attempt is made to move C-arm.

Set Up Computer

FES

- Set up the ISIS computer equipment.
- Set up the Hologic computer, keyboard, and mouse.
- Connect all computer equipment on the CPU cart to the CPU.

Power Up the UPS for the Hologic Horizon System

Technologist

Note: The mobile Hologic Horizon QDR System should be shut down only when necessary, primarily during road travel. Other than during road travel, the system should remain powered whenever possible, to avoid warm-up delays. Failure to follow this procedure may cause the UPS batteries to discharge and consequently require significant recharge time.

- Verify that the Horizon QDR main breaker is OFF, the UPS main breaker is OFF, and the UPS Stop/RUN switch is in the STOP position.
- Plug the Horizon QDR Power Module into one of the UPS outlets.
- Plug the UPS into a live power outlet (shore power or motor generator).
- If running on motor generator and generator is OFF, start the motor generator. If running on shore power, verify that the shore power link is ON.
- Switch on the UPS main breaker and wait 30 seconds. Verify that the AC line light on the UPS is lit.
- Switch the UPS STOP/RUN switch to RUN and wait for the end of the second long beep. Verify that the INVERTER light on the UPS is lit.
- If the UPS batteries are discharged, wait until the batteries are charged. (If you switch on the Horizon QDR table without waiting for the batteries to charge, you will lose power outage protection.)

Power Up the Horizon Table

Technologist

- Turn on (1) the Horizon QDR circuit breaker located on the back of the left pedestal. The green light should turn on.
- Allow 30 minutes warm-up time.
- On the control panel, press the Power button if it is not already on (the Power green indicator light should be illuminated).

Power Up the Horizon QDR Computer System

Technologist

- Turn the computer on (button located on the front of the CPU) and follow the startup procedures under Start of Stand Horizon QDR System Procedures.

Room Setup Procedures

Technologist

CPU cart setup and tie-down material removal:

- Remove tie-down strap from CPU cart and from wall anchors.
- Remove wall anchors (2) from walls.
- Store tie-down straps, wall anchors, and computer cozies in the supply bin.
- Check that ISIS CPU, ISIS keyboard, Hologic CPU, and Hologic monitor are still secured to CPU cart.
- Check that Horizon QDR UPS, phantom boxes, and Horizon table are still secured to the floor.

Supply setup:

- Unpack binders for DXA room and place on basket in grid.
- Unpack grid baskets from box and hang on wall grid.
- Restock containers in grid baskets where needed.
- Place Velcro foot strap in grid basket.
- Calibrate the portable scale and stadiometer.
- Restore trash can and chair to upright positions.
- Store supply bin in MEC belly during a stand.
- Make a final check on room setup.

Appendix D
Start of Stand Hologic Horizon
QDR System Procedures

Appendix D

Start of Stand Horizon QDR System Procedures

Power Up the Horizon QDR Computer System

- Turn the Hologic computer on (button located on front of CPU).
- The Windows blue screen will appear; click on the APEX icon.
- The Horizon QDR Main Menu will appear with a dialog box, “A backup of your QDR system’s database has not been performed in ___ days.” Follow the procedures listed under system backup to perform a system backup; otherwise, click “No” to proceed.
- The X-ray table will turn on and the Horizon QDR Main Menu will be displayed. Start QC procedures as outlined in Chapter 6.

System Backup

System backup is the function used to periodically save the system files in case there is a system failure such as a hard drive failure. It does not overwrite any files, such as older backup files. It does not save scanned image files.

After the Horizon QDR system has been turned on, log on to the APEX software. You will see a dialog box that reads, “A backup of your QDR system’s database has not been performed in ___ days.”

- Insert the current system backup disc into the hard drive.
- Click “Yes” on the dialog box.

Or:

- Insert system backup disc into the hard drive.
- Click the System Backup button on the main window. The “QDR System Backup” box will appear.
- Click on Browse. Under the “My Computer” tab find “Removable Disk (D:).” Click on it and then click “OK.” The backup process will begin.

Note: If you get an error message stating the file does not have enough free space, click “Cancel” and repeat the procedures with a new formatted CD.

This system backup CD should remain on that specific MEC until it is full. If the CD is full, return it to the home office.

Be sure to label the CD cover with “System Backup,” the MEC number “MEC #,” and the date “mm/dd/yyyy.”

A system backup should be performed at the Start of Stand, and prior to any Hologic service or repairs.

Formatting CD

- Minimize the Hologic Horizon QDR application.
- Place a blank CD in the drive.
- Wait for the dialog box to come up to format disc (CD:D).
- Click “Start.”
- Be sure to label the cover of the disc as “formatted” with the date “mm/dd/yyyy.”

Appendix E
DXA Bone Densitometer Report

Appendix E

DXA Bone Densitometer Report

DXA Bone Densitometer Report • NHANES

Stand: _____

MEC: Check the MEC number:

MEC 1	MEC 2	MEC 3
SPINE PHANTOM #102198	SPINE PHANTOM #102206	SPINE PHANTOM #102048
BODY COMPOSITION TBAR1479	BODY COMPOSITION TBAR1570	BODY COMPOSITION TBAR2429
RADIOGRAPHIC_UNIFORMITY	RADIOGRAPHIC_UNIFORMITY	RADIOGRAPHIC_UNIFORMITY
PHANTOM-FEMUR, WHF-1 #0018	PHANTOM, FEMUR WHF-0021	PHANTOM-FEMUR, WHF-1 #0013
PHANTOM-WB 1229	PHANTOM, WB-1224	PHANTOM-WB 1228

1. Have there been any software changes?

Yes

Old software version _____

New software version _____

Date installed _____

Was software change approved by University of Hawaii (UH) in advance?

Yes

No

By Whom? _____

No

2. Were there any Radiology Technologist (RT) changes?

Yes

RT Name: _____

Added

Departed

Date of Change _____

Date of UH Training _____

RT Name: _____

Added

Departed

Date of Change _____

Date of UH Training _____

No

3. Were there any maintenance/recalibration/repair problems?
 Yes, Service performed: _____ Date Performed: _____

 No
4. Additional comments:

5. Technologist: _____ Date: _____

DXA Bone Densitometer Service Report

A DXA Bone Densitometer Service Report is completed throughout a stand as needed and is sent to the home office component lead at the end of each stand. This report should be saved electronically in the service report folder located on the ISIS computer.

Throughout the stand, the Health Technologist Coordinator (HTC) will enter information in the DXA Bone Densitometer Report for the following situations:

- If software changes were made during the stand to the Hologic Horizon A system, the information should be entered on the report under Section #1.
- If there were changes to the Radiologic Technologists (RTs) during the stand, the information should be entered on the report under Section #2.
- If the Hologic Horizon A system/table required service or repair during a stand, the information should be entered on the report under Section #3 – **for each service or repair.**
 - The HTC will save an electronic copy of the Hologic engineer’s field service report (FSR) and/or a Field Service Report for Preventive Maintenance (FSR-PM) in the service report folder.

At the end of each stand, the HTC will complete the following tasks:

- Send an electronic copy of the report to the home office component lead at the end of each stand. The home office component lead will send this to NCHS and the Quality Control Reading Laboratory at the end of each stand.
- Email to the component lead an electronic copy of the FSR(s)/FSR-PM completed by the service engineer after the repair or service was made to the home office. The component lead will send a copy to NCHS and to the Quality Control Reading Laboratory at the end of each stand.

Appendix F
Start of Stand QC Scan Checklist

Appendix F

Start of Stand QC Scan Checklist

Stand#: _____ Tech ID#: _____

Type of scan	Scan 1	Scan 2	Scan 3	Scan 4	Scan 5	Scan 6	Scan 7	Scan 8	Scan 9	Scan 10
Spine Phantom	<input type="checkbox"/>									
Step Phantom	<input type="checkbox"/>									
Radiographic Uniformity Scan High Air SD = _____ Low Air SD = _____	<input type="checkbox"/>									
Hologic Slim-Line Whole Body Phantom (Slim-Line WB Phantom #XXXX)	<input type="checkbox"/>	<input type="checkbox"/>	<input type="checkbox"/>	<input type="checkbox"/>	<input type="checkbox"/>					
Circulating Hologic Whole Body Phantom (WB Phantom #008) <i>Only at the first stand of the year for each MEC</i>	<input type="checkbox"/>	<input type="checkbox"/>	<input type="checkbox"/>	<input type="checkbox"/>	<input type="checkbox"/>					
Circulating Spine Phantom (HSP Q96) <i>Only at the first stand of the year for each MEC</i>	<input type="checkbox"/>	<input type="checkbox"/>	<input type="checkbox"/>	<input type="checkbox"/>	<input type="checkbox"/>	<input type="checkbox"/>	<input type="checkbox"/>	<input type="checkbox"/>	<input type="checkbox"/>	<input type="checkbox"/>
Circulating Block Phantom (NHANES Block #1) <i>Only at the first stand of the year for each MEC</i>	<input type="checkbox"/>	<input type="checkbox"/>	<input type="checkbox"/>	<input type="checkbox"/>	<input type="checkbox"/>	<input type="checkbox"/>	<input type="checkbox"/>	<input type="checkbox"/>	<input type="checkbox"/>	<input type="checkbox"/>

Appendix G
Weekly QC Scan Checklist

Appendix G

Weekly QC Scan Checklist

Week of: _____

Tech ID#: _____

Please note: For Day 1 of the first week of each stand, it is not necessary to repeat scans that were done as part of the Start of Stand QC.

Daily:

Type of scan	Day 1 scan 1	Day 2 scan 1	Day 3 scan 1	Day 4 scan 1	Day 5 scan 1	Day 6 (if applicable) scan 1
Spine Phantom (HASP)	<input type="checkbox"/>	<input type="checkbox"/>	<input type="checkbox"/>	<input type="checkbox"/>	<input type="checkbox"/>	<input type="checkbox"/>
Slim-Line Whole Body Phantom	<input type="checkbox"/>		<input type="checkbox"/>		<input type="checkbox"/>	
Step Phantom (HASP)	<input type="checkbox"/>					
Radiographic Uniformity Scan						
High Air SD = _____	<input type="checkbox"/>					
Low Air SD = _____						

Appendix H

Teardown Procedures and Securing the Hologic Horizon QDR System for Travel

Appendix H

Teardown Procedures and Securing the Hologic Horizon QDR System for Travel

Power Down the Hologic Horizon QDR Computer System

Technologist

- Confirm with the Health Technologist Coordinator (HTC) that all files have been copied. If the HTC cannot confirm this, call ISIS Support at 301-610-4935 or 301-529-2208. ISIS has to copy all files before the Hologic computer is shut down for travel.
- If all files have been copied, make sure that the main window on the computer appears on the monitor and click “Exit” in the lower-right corner of the screen.
- In the Exit QDR System Dialog box that appears, select “Exit QDR with shutdown?” and click OK. This will shut down the APEX software and the Windows XP operating system.
- On the Hologic computer CPU, press the On/Off switch to power off the computer.

Power Down the Hologic Horizon A Table

Technologist

- Press “Center Table” switch on the control panel to position the C-arm and table in the middle of its range.
- Turn off the Horizon A System by pressing the power switch on the control panel. The green indicator in the power button should go out.
- On the back of the left pedestal, turn the circuit breaker switch to OFF (0).

Turn Off the Hologic Horizon A UPS

Technologist

- Switch the UPS STOP/RUN switch to STOP.
- Switch off the UPS main breaker.

Secure the C-Arm Stabilizer

Technologist/FES

- **Carefully Complete the Following Steps.** The stabilizer fits snugly between the C-arm and the table but it should not be forced.
- Place the notched end of the stabilizer on the bottom of the C-arm (tank end) and pivot the top toward the top of the C-arm.
- Position the stabilizer so that the top and bottom foam pads are wedged between the top of the tank cover and the bottom of the C-arm. **Be sure not to cover up the laser box.**
- The C-arm must be vertical.
- Secure stabilizer by clamping the Velcro strap tightly around the top of the C-arm and fasten it to the stabilizer pad.

Secure Carriage and Rotation Locks (3 Total)

Technologist/FES

- The table locking pin is located on the upper-left side of the table (front side of scanner).
- Turn the locking pin handle downward until the plunger releases and locks into place. (Budge table back and forth if locking pin does not engage at centered position).
- The C-arm carriage lock is located on the left side of the C-arm carriage (around the gas spring).
- Turn the locking pin handle until the plunger releases and locks into place.
- The carriage lock is located on the lower left side of the carriage.
- Turn the handle until the plunger releases and locks into place.
- Put laminated signs on C-arm and over the Hologic computer screens that indicate that the locking pins are in position.

Room Teardown Procedures

Technologist

- Follow specific ISIS instructions for teardown of computer equipment.
- Remove wall anchors and tie-down straps from supply bin stored in MEC belly.
- Attach all wall anchors to the walls.

- The FES will attach the long end of the strap to the wall anchor on the telephone wall and will attach the ratchet strap to the opposite corner wall anchor.
- Pack manuals into DXA supply bin.
- Consolidate supplies in grid baskets where possible, and pack grid baskets with supplies into DXA supply bin.
- Place extra paper roll in supply bin.
- Pack up portable scale and stadiometer.
- Do not disconnect the telephone from phone jack and receiver. Wrap rubber bands around the phone and receiver to secure for travel.
- Store packed DXA supply bin on floor. Nothing should be stored on the table.
- Make sure laminated signs are on Hologic monitor and C-arm: **“Locking pins are in position. Do not attempt to turn on DXA machine until the locking pin is removed.”**
- Anchor computer cart with nylon strap around cart legs and tighten ratchet.
- Check that the ISIS CPU, the ISIS keyboard, the Hologic CPU, and the Hologic monitor are all secured to the computer cart.
- Check that the UPS, the phantom boxes, and the DXA are secured to the floor.
- Turn room chair upside down.
- Turn trash can on its side.
- Make final check on pickup of the room with the chief technologist.

Room Teardown Procedures

Technologist

- Disconnect ISIS monitor from CPU.
- Remove ISIS monitor from cart and place in box with packing material.
- Disconnect both mice and Hologic keyboard from CPU.
- Place all packed boxes on the floor. Nothing should be stored on the bed of the DXA table.
- Unplug all electrical equipment.

Appendix I
Power Failure Procedures for DXA

Appendix I

Power Failure Procedures for DXA

For a Power Failure

Shutting down:

- If the system was inoperative when the power failure occurred, assist the SP from the table. (The On/Off switch will be inoperative at this time).
- Turn off the computer.
- Turn off the circuit breaker located on the back of the left pedestal (the green indicator should already be off due to the power failure).

After power is restored:

- After waiting for a few minutes for the power to stabilize, turn on the circuit breaker (the green light should turn on).
- Turn on the computer.
- Perform start of session procedures.

If equipment fails while in operation:

- On the control panel, press the red Emergency Stop Button. (The table and the C-arm immediately stop moving, and the X-rays and laser turn off).
- Assist the SP off the table.
- Turn off the circuit breaker.
- Disconnect the power cord from the AC outlet (if possible).
- Call Hologic customer service.

If AC power has been turned off:

- If necessary, plug the power cord into the AC outlet.
- Place the circuit breaker in the ON (1) position (the green light should illuminate).
- Perform the start of session procedures.

Appendix J
Script for Parents

Appendix J

Script for Parents



NHANES Dual-Energy X-Ray Absorptiometry (DXA) Scan

As part of the National Health and Nutrition Examination Survey exam, your child will have a DXA scan of the whole body. This scan provides information on the amounts of fat, lean tissue (like muscle), and bone in the body. The scan uses X-ray energy, which is also known as radiation.

The amount of radiation your child will be exposed to is extremely small. It is less than the amount of natural background radiation the average person living in the United States is exposed to every day, which is about 8 microsieverts (uSv). It is also less than the radiation exposure from an airplane flight across the United States, which is about 30 uSv. The Sievert is a unit of effective dosage radiation.

Depending on their age, your child will receive a radiation dose of 4.2 to 4.8 μ Sv during the whole body scan.

The information from your child's DXA scan will be used with other NHANES information such as height and weight, to help doctors and other health professionals better deal with health problems that may affect children.

Thank you for participating in NHANES!



Densitometría ósea para NHANES

Como parte de la Encuesta Nacional de Examen de Salud y Nutrición, a su niño se le hará una densitometría ósea de todo el cuerpo, DXA por sus siglas en inglés. Este examen proporciona información acerca de la cantidad de grasa, tejidos sin grasa (como músculos) y los huesos del cuerpo. Este examen usa energía de rayos X, también conocida como radiación.

La cantidad de radiación a la que estará expuesto su niño es mínima. Es menos que la cantidad de radiación natural a la que, en promedio, se expone una persona todos los días en Estados Unidos, la cual es aproximadamente 8 microsievets (uSv). Es también menos que la exposición a la radiación en un viaje en avión por Estados Unidos, la cual es aproximadamente 30 uSv. El sievert es una unidad que mide la dosis efectiva de radiación.

Dependiendo de la edad, el niño recibirá una dosis de radiación de 4.2 a 4.8 μ Sv durante todo el examen.

La información de la densitometría ósea de su niño se usará con otra información de NHANES, como la estatura y el peso, con el fin de ayudar a médicos y a otros profesionales de la salud a tratar mejor los problemas de salud que pueden afectar a los niños.

¡Gracias por participar en NHANES!